

# System SLIO

SM-DIO || Manual

HB300 | SM-DIO || en | 23-20

Digital signal modules - SM 02x



VIPA USA, INC  
980 Birmingham Rd. Ste 721  
Alpharetta, GA 30004 USA

Tel.: +1 (678) 880-6910  
Email: [info@vipausa.com](mailto:info@vipausa.com)  
Internet: [www.vipausa.com](http://www.vipausa.com)

## Table of contents

<b>1</b>	<b>General</b> .....	<b>6</b>
1.1	Copyright © YASKAWA Europe GmbH.....	6
1.2	About this manual.....	7
1.3	Safety information.....	7
<b>2</b>	<b>Basics and mounting</b> .....	<b>9</b>
2.1	Safety notes for the user.....	9
2.2	System conception.....	10
2.2.1	Overview.....	10
2.2.2	Components.....	11
2.2.3	Accessories.....	14
2.2.4	Hardware revision.....	16
2.3	Dimensions.....	16
2.4	Mounting 8x periphery modules.....	19
2.5	Mounting 16x periphery modules.....	22
2.6	Wiring 8x periphery modules.....	24
2.7	Wiring 16x periphery modules.....	26
2.8	Wiring power modules.....	27
2.9	Demounting 8x periphery modules.....	32
2.10	Demounting 16x periphery modules.....	35
2.11	Easy Maintenance.....	38
2.12	Trouble shooting - LEDs.....	39
2.13	Industrial security and installation guidelines.....	40
2.13.1	Industrial security in information technology.....	40
2.13.2	Installation guidelines.....	42
2.14	General data for the System SLIO.....	44
2.14.1	Use in difficult operating conditions.....	46
2.15	System SLIO product variants for extended application range.....	47
<b>3</b>	<b>Digital input</b> .....	<b>48</b>
3.1	021-1BB00 - DI 2xDC 24V.....	48
3.1.1	Technical data.....	50
3.2	021-1BB10 - DI 2xDC 24V 2µs...3ms.....	52
3.2.1	Technical data.....	54
3.2.2	Parameter data.....	56
3.2.3	Diagnostics and interrupt.....	57
3.3	021-1BB50 - DI 2xDC 24V NPN.....	61
3.3.1	Technical data.....	63
3.4	021-1BB70 - DI 2xDC 24V ETS.....	65
3.4.1	Technical data.....	69
3.4.2	Parameter data.....	71
3.4.3	Diagnostic data.....	74
3.5	021-1BD00 - DI 4xDC 24V.....	76
3.5.1	Technical data.....	78
3.6	021-1BD10 - DI 4xDC 24V 2µs...3ms.....	80
3.6.1	Technical data.....	82
3.6.2	Parameter data.....	84
3.6.3	Diagnostics and interrupt.....	85
3.7	021-1BD40 - DI 4xDC 24V 3 wire.....	89

3.7.1	Technical data.....	91
3.8	021-1BD50 - DI 4xDC 24V NPN.....	93
3.8.1	Technical data.....	95
3.9	021-1BD70 - DI 4xDC 24V ETS.....	97
3.9.1	Technical data.....	101
3.9.2	Parameter data.....	103
3.9.3	Diagnostic data.....	106
3.10	021-1BF00 - DI 8xDC 24V.....	109
3.10.1	Technical data.....	111
3.11	021-1BF01 - DI 8xDC 24V 0.5ms.....	114
3.11.1	Technical data.....	116
3.12	021-1BF50 - DI 8xDC 24V NPN.....	119
3.12.1	Technical data.....	121
3.13	021-1BH00 - DI 16xDC 24V.....	124
3.13.1	Technical data.....	126
3.13.2	Parameter data.....	128
3.14	021-1DF00 - DI 8xDC 24V Diagnosis.....	130
3.14.1	Technical data.....	132
3.14.2	Parameter data.....	134
3.14.3	Diagnostic data.....	135
<b>4</b>	<b>Digital output.....</b>	<b>138</b>
4.1	022-1BB00 - DO 2xDC 24V 0.5A.....	138
4.1.1	Technical data.....	140
4.2	022-1BB20 - DO 2xDC 24V 2A.....	143
4.2.1	Technical data.....	145
4.3	022-1BB70 - DO 2xDC 24V 0.5A ETS.....	148
4.3.1	Technical data.....	154
4.3.2	Parameter data.....	156
4.3.3	Diagnostic data.....	161
4.4	022-1BB90 - DO 2xDC 24V 0.5A PWM.....	163
4.4.1	Technical data.....	166
4.4.2	Parameter data.....	169
4.4.3	Diagnostic data.....	170
4.5	022-1BD00 - DO 4xDC 24V 0.5A.....	172
4.5.1	Technical data.....	174
4.6	022-1BD20 - DO 4xDC 24V 2A.....	177
4.6.1	Technical data.....	179
4.7	022-1BD50 - DO 4xDC 24V 0.5A NPN.....	182
4.7.1	Technical data.....	184
4.8	022-1BD70 - DO 4xDC 24V 0.5A ETS.....	187
4.8.1	Technical data.....	193
4.8.2	Parameter data.....	195
4.8.3	Diagnostic data.....	200
4.9	022-1BF00 - DO 8xDC 24V 0.5A.....	202
4.9.1	Technical data.....	204
4.10	022-1BF01 - DO 8xDC 24V 0.5A.....	207
4.10.1	Technical data.....	210
4.11	022-1BF50 - DO 8xDC 24V 0.5A NPN.....	213
4.11.1	Technical data.....	215



---

4.12	022-1BH00 - DO 16xDC 24V 0.5A.....	218
4.12.1	Technical data.....	220
4.12.2	Parameter data.....	223
4.12.3	Diagnostic data.....	223
4.13	022-1DF00 - DO 8xDC 24V 0.5A Diagnostic.....	226
4.13.1	Technical data.....	228
4.13.2	Parameter data.....	230
4.13.3	Diagnostic data.....	231
4.14	022-1HB10 - DO 2xRelay.....	234
4.14.1	Technical data.....	236
4.15	022-1HD10 - DO 4xRelay.....	239
4.15.1	Technical data.....	242

# 1 General

## 1.1 Copyright © YASKAWA Europe GmbH

<b>All Rights Reserved</b>	<p>This document contains proprietary information of Yaskawa and is not to be disclosed or used except in accordance with applicable agreements.</p> <p>This material is protected by copyright laws. It may not be reproduced, distributed, or altered in any fashion by any entity (either internal or external to Yaskawa) except in accordance with applicable agreements, contracts or licensing, without the express written consent of Yaskawa and the business management owner of the material.</p> <p>For permission to reproduce or distribute, please contact: YASKAWA Europe GmbH, European Headquarters, Philipp-Reis-Str. 6, 65795 Hattersheim, Germany</p> <p>Tel.: +49 6196 569 300 Fax.: +49 6196 569 398 Email: <a href="mailto:info@yaskawa.eu">info@yaskawa.eu</a> Internet: <a href="http://www.yaskawa.eu.com">www.yaskawa.eu.com</a></p>
<b>EC conformity declaration</b>	<p>Hereby, YASKAWA Europe GmbH declares that the products and systems are in compliance with the essential requirements and other relevant provisions. Conformity is indicated by the CE marking affixed to the product.</p>
<b>Conformity Information</b>	<p>For more information regarding CE marking and Declaration of Conformity (DoC), please contact your local representative of YASKAWA Europe GmbH.</p>
<b>Trademarks</b>	<p>SLIO is a registered trademark of YASKAWA Europe GmbH.</p> <p>CAN is a registered trademark of CAN in Automation e. V. (CiA).</p> <p>EtherCAT is a registered trademark of Beckhoff Automation GmbH.</p> <p>PROFINET and PROFIBUS are registered trademarks of PROFIBUS and PROFINET International (PI).</p> <p>All other trademarks, logos and service or product marks specified herein are owned by their respective companies.</p>
<b>General terms of use</b>	<p>Every effort has been made to ensure that the information contained in this document was complete and accurate at the time of publishing. We cannot guarantee that the information is free of errors, and we reserve the right to change the information at any time. There is no obligation to inform the customer about any changes. The customer is requested to actively keep his documents up to date. The customer is always responsible for the deployment of the products with the associated documentation, taking into account the applicable directives and standards.</p> <p>This documentation describes all hardware and software units and functions known today. It is possible that units are described that do not exist at the customer. The exact scope of delivery is described in the respective purchase contract.</p>
<b>Document support</b>	<p>Contact your local representative of YASKAWA Europe GmbH if you have errors or questions regarding the content of this document. You can reach YASKAWA Europe GmbH via the following contact:</p> <p>Email: <a href="mailto:Documentation.HER@yaskawa.eu">Documentation.HER@yaskawa.eu</a></p>

**Technical support**

Contact your local representative of YASKAWA Europe GmbH if you encounter problems or have questions regarding the product. If such a location is not available, you can reach the Yaskawa customer service via the following contact:

YASKAWA Europe GmbH,  
European Headquarters, Philipp-Reis-Str. 6, 65795 Hattersheim, Germany  
Tel.: +49 6196 569 500 (hotline)  
Email: support@yaskawa.eu

## 1.2 About this manual

**Objective and contents**

This manual describes the Digital signal modules of the System SLIO.

- It describes the structure, configuration and application.
- The manual is written for users with basic knowledge of automation technology.
- The manual consists of chapters. Each chapter describes a completed topic.
- The following guides are available in the manual:
  - An overall table of contents at the beginning of the manual.
  - References with pages numbers.

**Icons Headings**

Important passages in the text are highlighted by following icons and headings:

**DANGER!**

Immediate or likely danger. Personal injury is possible.

**CAUTION!**

Damages to property is likely if these warnings are not heeded.



*Supplementary information and useful tips.*

## 1.3 Safety information

**Applications conforming with specifications**

The system is constructed and produced for:

- communication and process control
- general control and automation tasks
- industrial applications
- operation within the environmental conditions specified in the technical data
- installation into a cubicle

**DANGER!**

This device is not certified for applications in

- in explosive environments (EX-zone)

**Documentation**

The manual must be available to all personnel in the

- project design department
- installation department
- commissioning
- operation

**CAUTION!**

**The following conditions must be met before using or commissioning the components described in this manual:**

- Hardware modifications to the process control system should only be carried out when the system has been disconnected from power!
- Installation and hardware modifications only by properly trained personnel.
- The national rules and regulations of the respective country must be satisfied (installation, safety, EMC ...)

**Disposal**

**National rules and regulations apply to the disposal of the unit!**

## 2 Basics and mounting

### 2.1 Safety notes for the user



#### **DANGER!**

##### **Protection against dangerous voltages**

- When using System SLIO modules, the user must be protected from touching hazardous voltage.
- You must therefore create an insulation concept for your system that includes safe separation of the potential areas of ELV and hazardous voltage.
- Here, observe the insulation voltages between the potential areas specified for the System SLIO modules and take suitable measures, such as using PELV/SELV power supplies for System SLIO modules.

#### **Handling of electrostatic sensitive modules**

The modules are equipped with highly integrated components in MOS technology. These components are highly sensitive to over-voltages that occur, e.g. with electrostatic discharge. The following symbol is used to identify these hazardous modules:



The symbol is located on modules, module racks or on packaging and thus indicates electrostatic sensitive modules. Electrostatic sensitive modules can be destroyed by energies and voltages that are far below the limits of human perception. If a person who is not electrically discharged handles electrostatic sensitive modules, voltages can occur and damage components and thus impair the functionality of the modules or render the modules unusable. Modules damaged in this way are in most cases not immediately recognized as faulty. The error can only appear after a long period of operation. Components damaged by static discharge can show temporary faults when exposed to temperature changes, vibrations or load changes. Only the consistent use of protective devices and responsible observance of the handling rules can effectively prevent malfunctions and failures on electrostatic sensitive modules.

#### **Shipping of modules**

Please always use the original packaging for shipping.

#### **Measurement and modification of electrostatic sensitive modules**

For measurements on electrostatic sensitive modules the following must be observed:

- Floating measuring instruments must be discharged before use.
- Measuring instruments used must be grounded.

When modifying electrostatic sensitive modules, ensure that a grounded soldering iron is used.



#### **CAUTION!**

When working with and on electrostatic sensitive modules, make sure that personnel and equipment are adequately grounded.

## 2.2 System conception

### 2.2.1 Overview

The System SLIO is a modular automation system for assembly on a 35mm mounting rail. By means of the periphery modules with 2, 4, 8 and 16 channels this system may properly be adapted matching to your automation tasks. The wiring complexity is low, because the supply of the DC 24V power section supply is integrated to the backplane bus and defective modules may be replaced with standing wiring. By deployment of the power modules in contrasting colors within the system, further isolated areas may be defined for the DC 24V power section supply, respectively the electronic power supply may be extended with 2A.

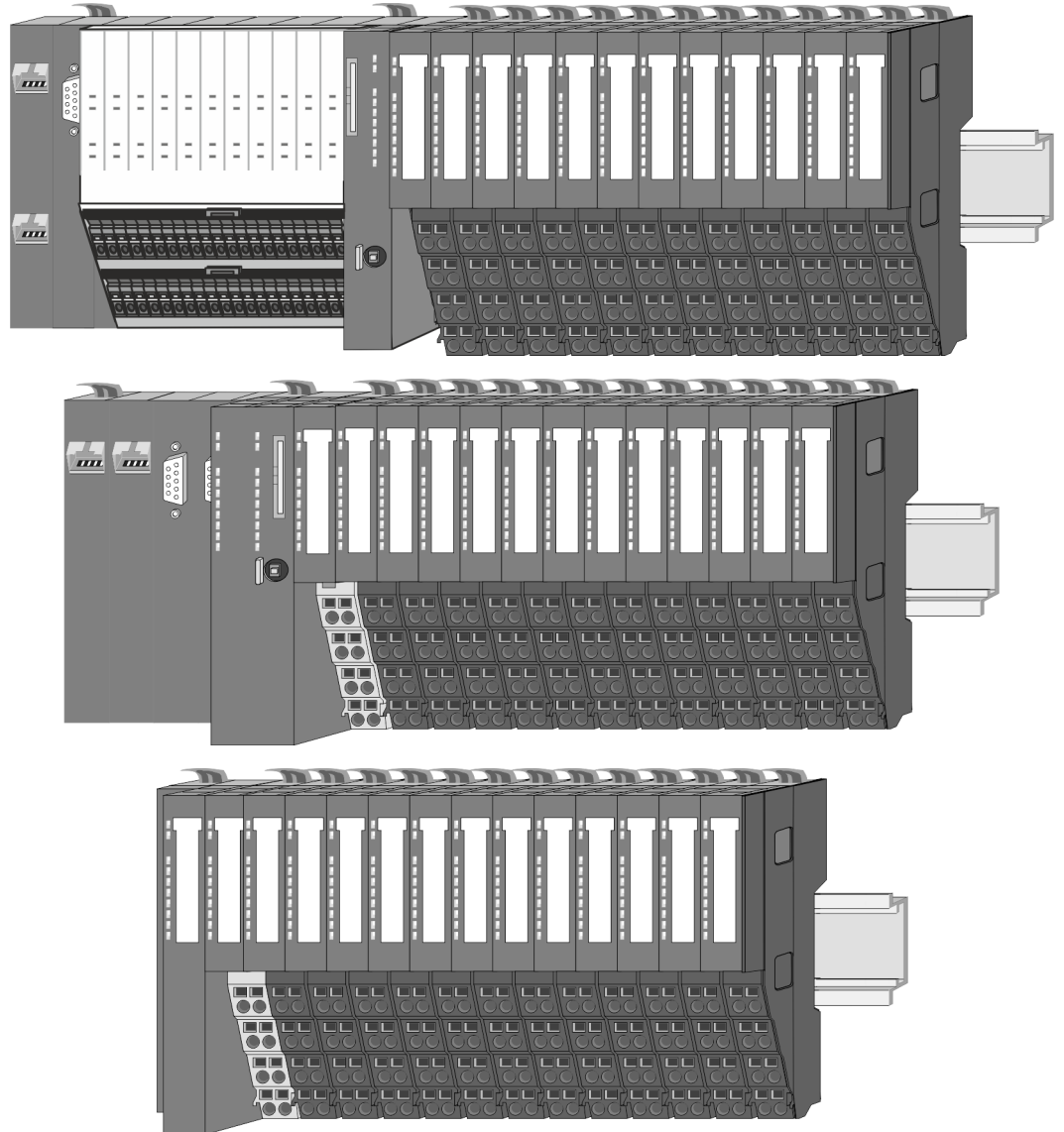

## 2.2.2 Components

- CPU (head module)
- Bus coupler (head module)
- Line extension
- 8x periphery modules
- 16x periphery modules
- Power modules
- Accessories



### CAUTION!

Only Yaskawa modules may be combined. A mixed operation with third-party modules is not allowed!

### CPU 01xC

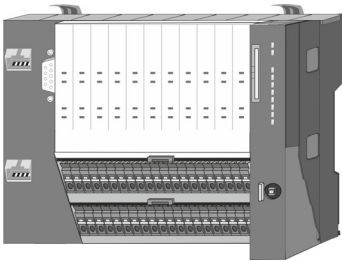

With the CPU 01xC electronic, input/output components and power supply are integrated to one casing. In addition, up to 64 periphery modules of the System SLIO can be connected to the backplane bus. As head module via the integrated power module for power supply CPU electronic and the I/O components are supplied as well as the electronic of the periphery modules, which are connected via backplane bus. To connect the power supply of the I/O components and for DC 24V power section supply of via backplane bus connected periphery modules, the CPU has removable connectors. By installing of up to 64 periphery modules at the backplane bus, these are electrically connected, this means these are assigned to the backplane bus, the electronic modules are power supplied and each periphery module is connected to the DC 24V power section supply.

### CPU 01x

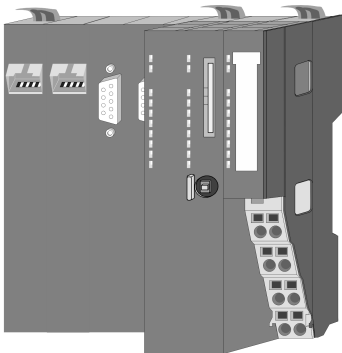

With this CPU 01x, CPU electronic and power supply are integrated to one casing. As head module, via the integrated power module for power supply, CPU electronic and the electronic of the connected periphery modules are supplied. The DC 24V power section supply for the linked periphery modules is established via a further connection of the power module. By installing of up to 64 periphery modules at the backplane bus, these are electrically connected, this means these are assigned to the backplane bus, the electronic modules are power supplied and each periphery module is connected to the DC 24V power section supply.



### CAUTION!

CPU part and power module may not be separated!  
Here you may only exchange the electronic module!

**Bus coupler**

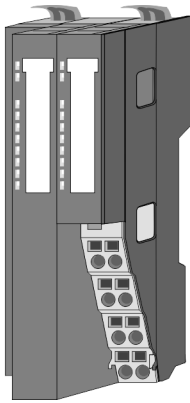

With a bus coupler bus interface and power module is integrated to one casing. With the bus interface you get access to a subordinated bus system. As head module, via the integrated power module for power supply, bus interface and the electronic of the connected periphery modules are supplied. The DC 24V power section supply for the linked periphery modules is established via a further connection of the power module. By installing of up to 64 periphery modules at the bus coupler, these are electrically connected, this means these are assigned to the backplane bus, the electronic modules are power supplied and each periphery module is connected to the DC 24V power section supply.



**CAUTION!**

Bus interface and power module may not be separated!  
Here you may only exchange the electronic module!

**Line extension**

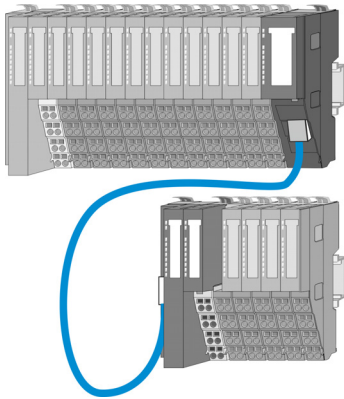

In the System SLIO there is the possibility to place up to 64 modules in on line. By means of the line extension you can divide this line into several lines. Here you have to place a line extension master at each end of a line and the subsequent line has to start with a line extension slave. Master and slave are to be connected via a special connecting cable. In this way, you can divide a line on up to 5 lines. Depending on the line extension, the max. number of pluggable modules at the System SLIO bus is decreased accordingly. To use the line extension no special configuration is required.



*Please note that some modules do not support line extensions due to the system. For more information, please refer to the compatibility list. This can be found in the 'Download Center' of [www.yaskawa.eu.com](http://www.yaskawa.eu.com) under 'System SLIO Compatibility list'.*

**Periphery modules**

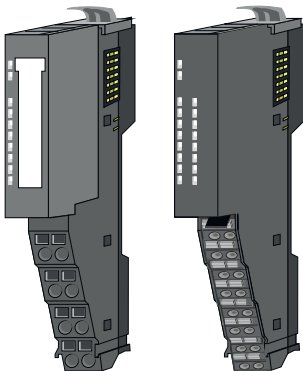

The periphery modules are available in the following 2 versions, whereby of each the electronic part can be replaced with standing wiring:

- 8x periphery module for a maximum of 8 channels.
- 16x periphery module for a maximum of 16 channels.



**8x periphery modules**

Each 8x periphery module consists of a *terminal* and an *electronic module*.

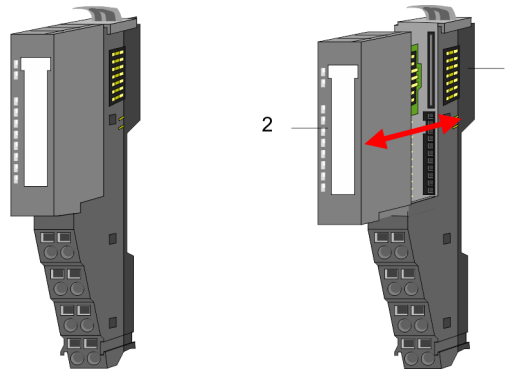

- 1 Terminal module
- 2 Electronic module

**Terminal module**

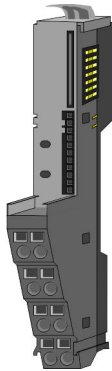

The *terminal* module serves to carry the electronic module, contains the backplane bus with power supply for the electronic, the DC 24V power section supply and the staircase-shaped terminal for wiring. Additionally the terminal module has a locking system for fixing at a mounting rail. By means of this locking system your system may be assembled outside of your switchgear cabinet to be later mounted there as whole system.

**Electronic module**

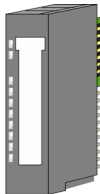

The functionality of a periphery module is defined by the *electronic module*, which is mounted to the terminal module by a sliding mechanism. With an error the defective electronic module may be exchanged for a functional module with standing installation. At the front side there are LEDs for status indication. For simple wiring each module shows corresponding connection information at the front and at the side.

**16x periphery modules**

Each 16x periphery module consists of an *electronic unit* and a *terminal block*.

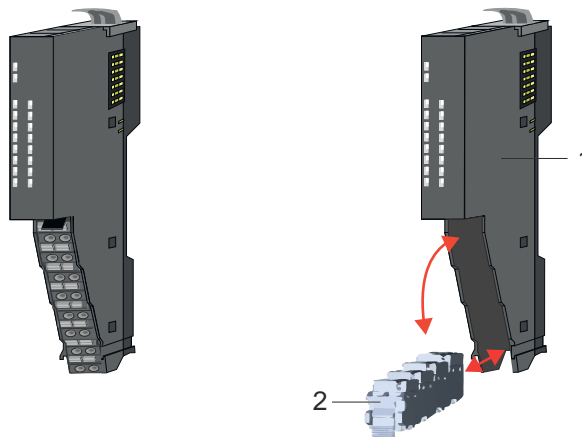

- 1 Electronic unit
- 2 Terminal block

**Electronic unit**

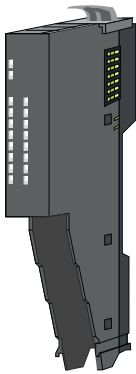

The functionality of a 16x periphery module is defined via the terminal block, which is connected to the *electronic unit* via a secure flap mechanism. In the case of an error you can exchange the defective electronic unit for a functional unit with standing wiring. At the front side there are LEDs for status indication. For easy wiring each electronic unit shows corresponding connection information at the side. The electronic unit provides the slot for the terminal block for the wiring and contains the backplane bus with power supply for the electronic and the connection to the DC 24V power section supply. Additionally the electronic unit has a locking system for fixing it at a mounting rail. By means of this locking system your system may be assembled outside of your switchgear cabinet to be later mounted there as whole system.

**Terminal block**



The *terminal block* provides the electrical interface for the signalling and supplies lines of the module. When mounting the terminal block, it is attached to the bottom of the electronic unit and turned towards the electronic unit until it clicks into place. With the wiring a "push-in" spring-clip technique is used. This allows a quick and easy connection of your signal and supply lines. The clamping off takes place by means of a screwdriver.

**Power module**

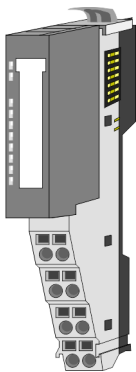

In the System SLIO the power supply is established by power modules. These are either integrated to the head module or may be installed between the periphery modules. Depending on the power module isolated areas of the DC 24V power section supply may be defined respectively the electronic power supply may be extended with 2A. For better recognition the colour of the power modules are contrasting to the periphery modules.

**2.2.3 Accessories**

**Shield bus carrier**



*Please note that a shield bus carrier cannot be mounted on a 16x periphery module!*



The shield bus carrier (order no.: 000-0AB00) serves to carry the shield bus (10mm x 3mm) to connect cable shields. Shield bus carriers, shield bus and shield fixings are not in the scope of delivery. They are only available as accessories. The shield bus carrier is mounted underneath the terminal of the terminal module. With a flat mounting rail for adaptation to a flat mounting rail you may remove the spacer of the shield bus carrier.

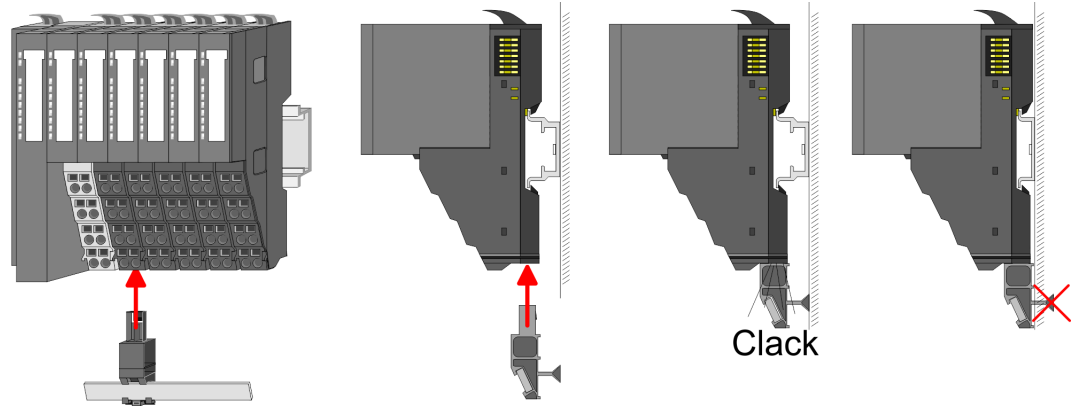

**Bus cover**

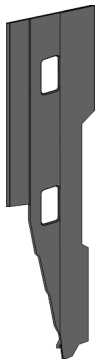

With each head module, to protect the backplane bus connectors, there is a mounted bus cover in the scope of delivery. You have to remove the bus cover of the head module before mounting a System SLIO module. For the protection of the backplane bus connector you always have to mount the bus cover at the last module of your system again. The bus cover has the order no. 000-0AA00.

**Coding pins**



*Please note that a coding pin cannot be installed on a 16x periphery module! Here you have to make sure that the associated terminal block is plugged again when the electronics unit is replaced.*

There is the possibility to fix the assignment of electronic and terminal module. Here coding pins (order number 000-0AC00) can be used. The coding pin consists of a coding jack and a coding plug. By combining electronic and terminal module with coding pin, the coding jack remains in the electronic module and the coding plug in the terminal module. This ensures that after replacing the electronic module just another electronic module can be plugged with the same encoding.

### 2.2.4 Hardware revision

#### Hardware revision on the front

- The hardware revision is printed on every System SLIO module.
- Since a System SLIO 8x peripheral module consists of a terminal and electronic module, you will find a hardware revision printed on each of them.
- Authoritative for the hardware revision of a System SLIO module is the hardware revision of the electronic module. This is located under the labeling strip of the corresponding electronic module.
- Depending on the module type, there are the following 2 variants e.g. to indicate hardware revision 1:
  - With current labelling there is a 1 on the front.
  - With earlier labelling, the 1 is marked with 'X' on a number grid.

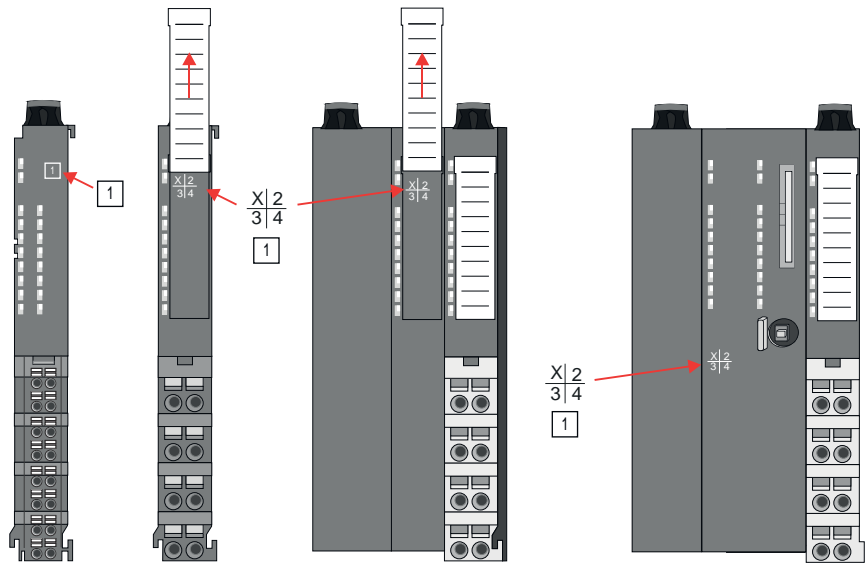

#### Hardware revision via web server

On the CPUs and some bus couplers, you can check the hardware revision 'HW Revision' via the integrated web server.

## 2.3 Dimensions

### CPU 01xC

All dimensions are in mm.

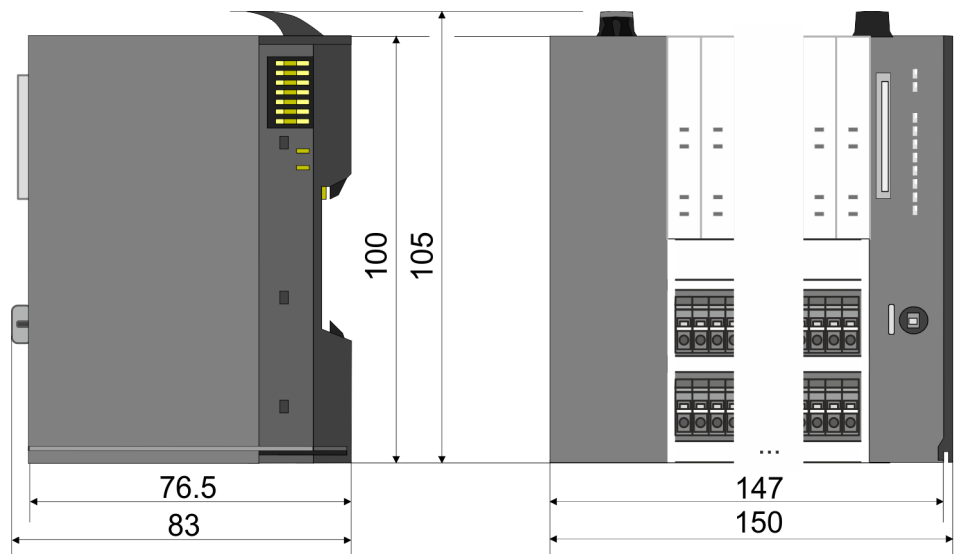

## CPU 01x

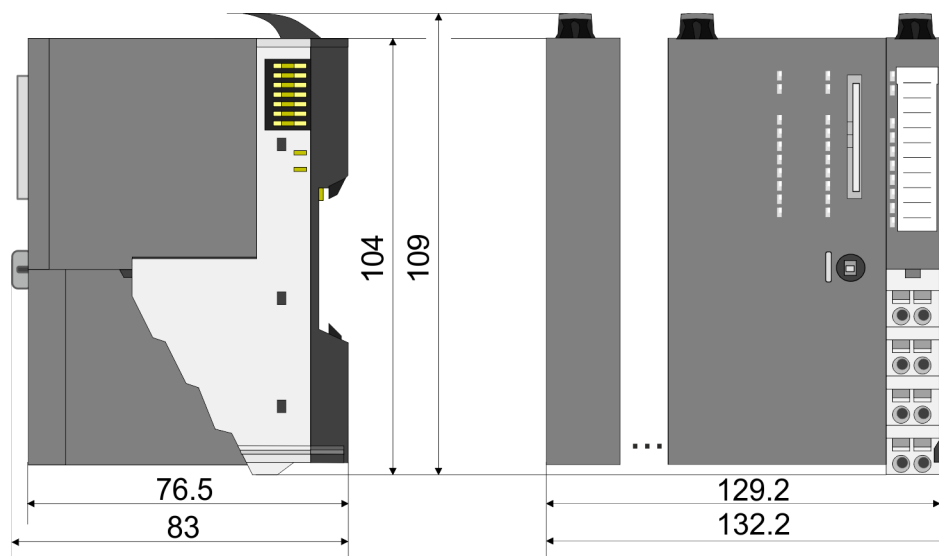

## Bus coupler and line extension slave

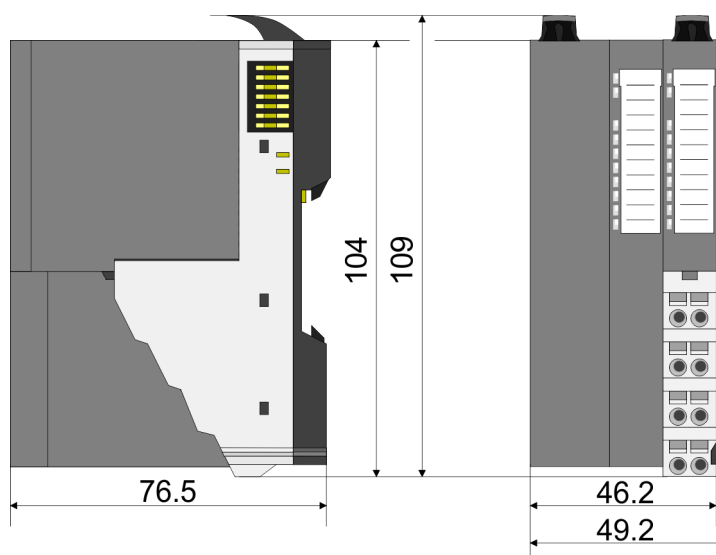

## Line extension master

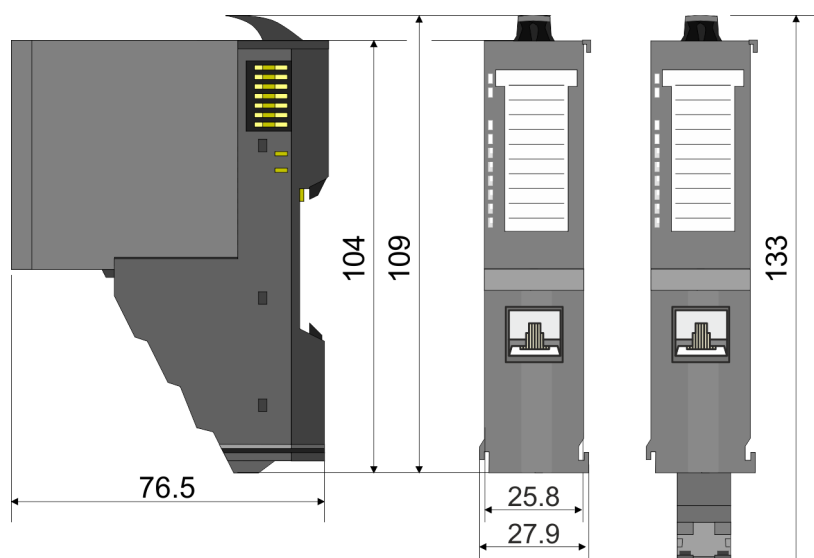

Dimensions

8x periphery module

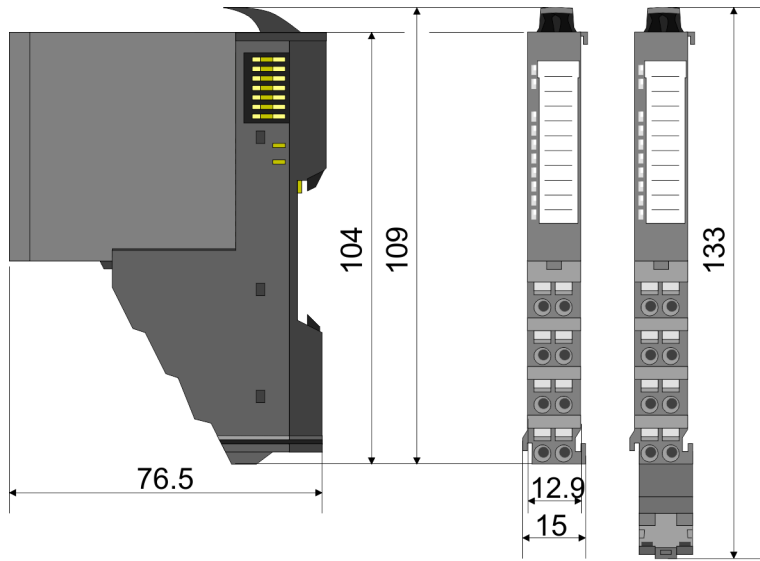

Electronic module

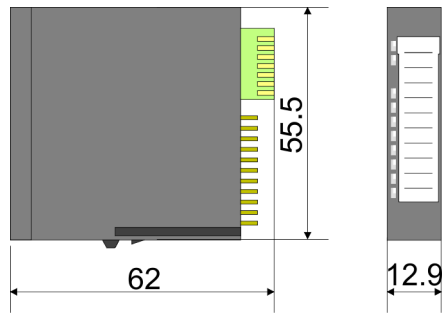

16x periphery module

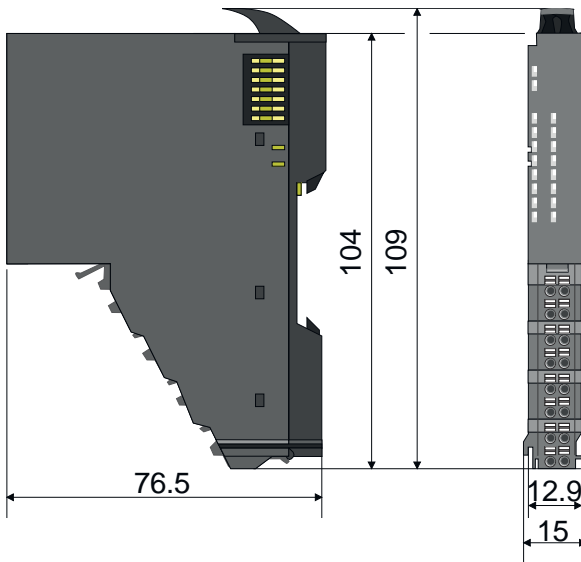

## 2.4 Mounting 8x periphery modules



### CAUTION!

#### Requirements for UL compliance use

- Use for power supply exclusively SELV/PELV power supplies.
- The System SLIO must be installed and operated in a housing according to IEC 61010-1 9.3.2 c).

There is a locking lever at the top side of the module. For mounting and demounting this locking lever is to be turned upwards until this engages. For mounting place the module to the module installed before and push the module to the mounting rail guided by the strips at the upper and lower side of the module. The module is fixed to the mounting rail by pushing downward the locking lever. The modules may either separately be mounted to the mounting rail or as block. Here is to be considered that each locking lever is opened. The modules are each installed on a mounting rail. The electronic and power section supply are connected via the backplane bus. Up to 64 modules may be mounted. Please consider here that the sum current of the electronic power supply does not exceed the maximum value of 3A. By means of the power module 007-1AB10 the current of the electronic power supply may be expanded accordingly.

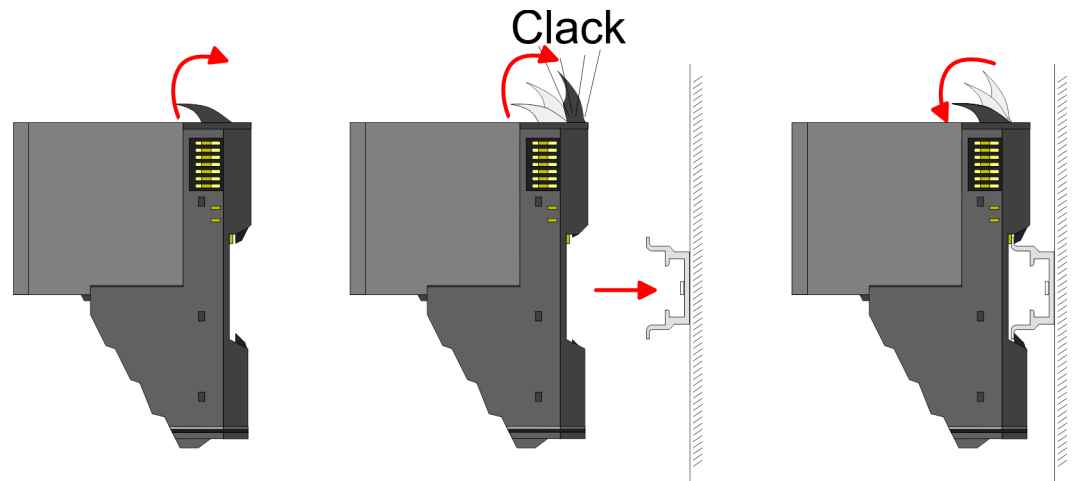

### Terminal and electronic module

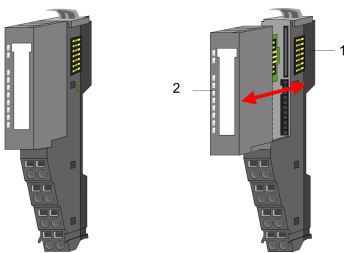

Each periphery module consists of a *terminal* and an *electronic module*.

- 1 Terminal module
- 2 Electronic module

For the exchange of a electronic module, the electronic module may be pulled forward after pressing the unlocking lever at the lower side of the module. For installation plug the electronic module guided by the strips at the lower side until this engages audible to the terminal module.

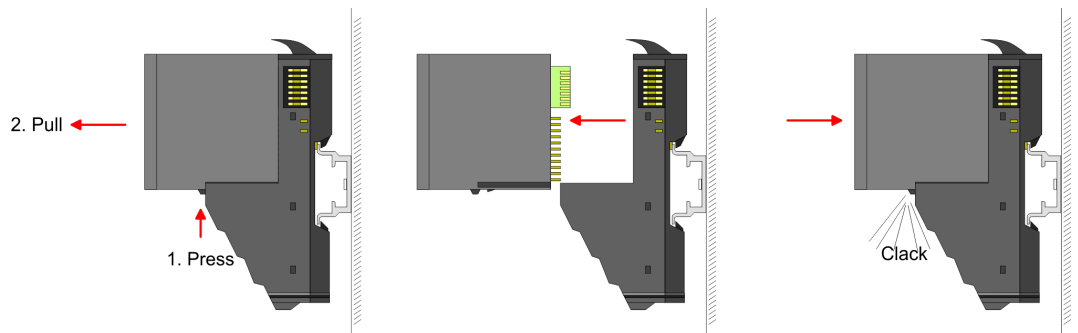

Coding



There is the possibility to fix the assignment of electronic and terminal module. Here coding pins (order number 000-0AC00) can be used. The coding pin consists of a coding jack and a coding plug. By combining electronic and terminal module with coding pin, the coding jack remains in the electronic module and the coding plug in the terminal module. This ensures that after replacing the electronics module just another electronic module can be plugged with the same encoding.

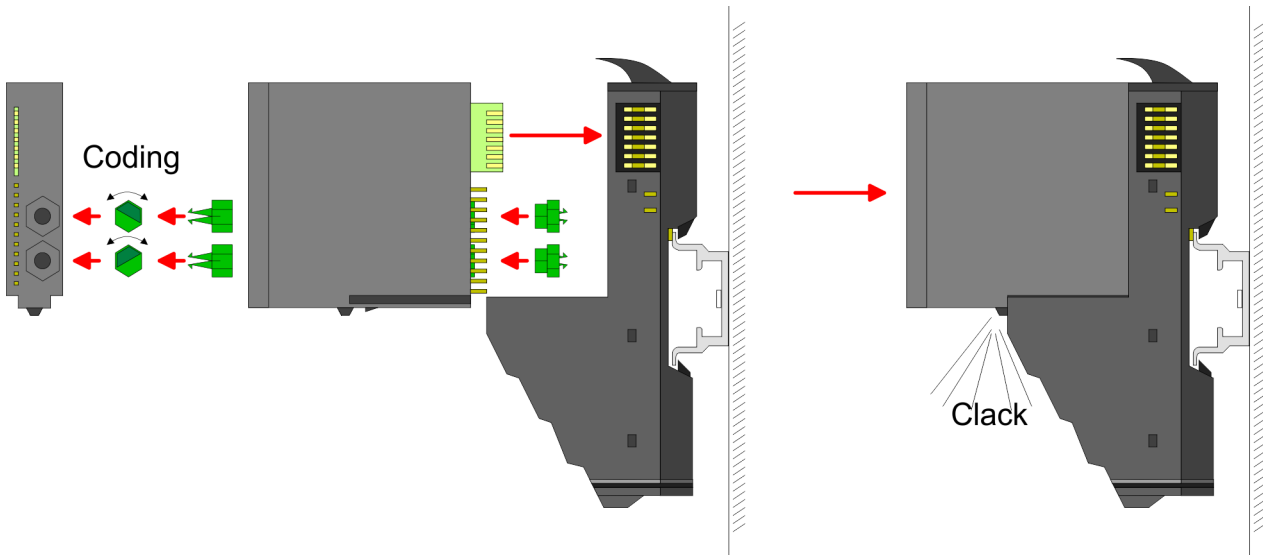

Each electronic module has on its back 2 coding sockets for coding jacks. Due to the characteristics, with the coding jack 6 different positions can be plugged, each. Thus there are 36 possible combinations for coding with the use of both coding sockets.

1. Plug, according to your coding, 2 coding jacks in the coding sockets of your electronic module until they lock
2. Now plug the according coding plugs into the coding jacks.
3. To fix the coding put both the electronic and terminal module together until they lock



**CAUTION!**

Please consider that when replacing an already coded electronic module, this is always be replaced by an electronic module with the same coding.

Even with an existing coding on the terminal module, you can plug an electronic module without coding. The user is responsible for the correct usage of the coding pins. Yaskawa assumes no liability for incorrectly attached electronic modules or for damages which arise due to incorrect coding!



### Mounting periphery modules

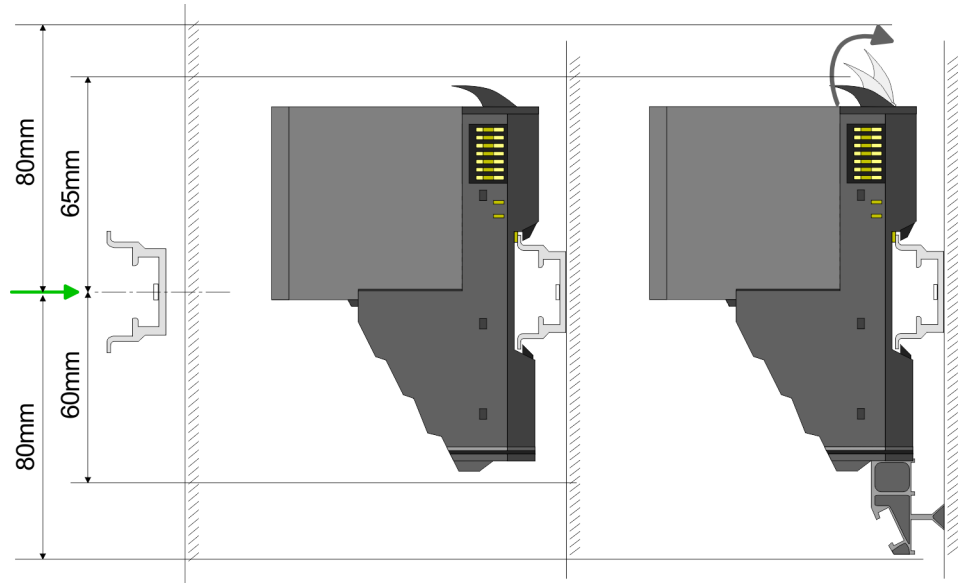

1. ➤ Mount the mounting rail! Please consider that a clearance from the middle of the mounting rail of at least 80mm above and 60mm below, respectively 80mm by deployment of shield bus carriers, exist.
2. ➤ Mount your head module such as CPU or field bus coupler.
3. ➤ Before mounting the periphery modules you have to remove the bus cover at the right side of the head module by pulling it forward. Keep the cover for later mounting.

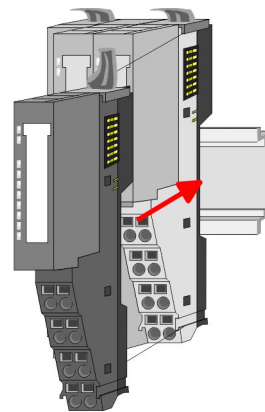
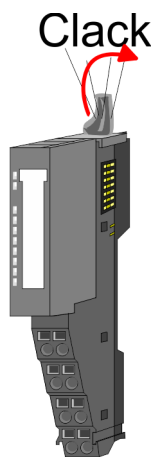

4. ➤ For mounting turn the locking lever of the module upwards until it engages.
5. ➤ For mounting place the module to the module installed before and push the module to the mounting rail guided by the strips at the upper and lower side of the module.
6. ➤ Turn the locking lever of the periphery module downward, again.

Mounting 16x periphery modules

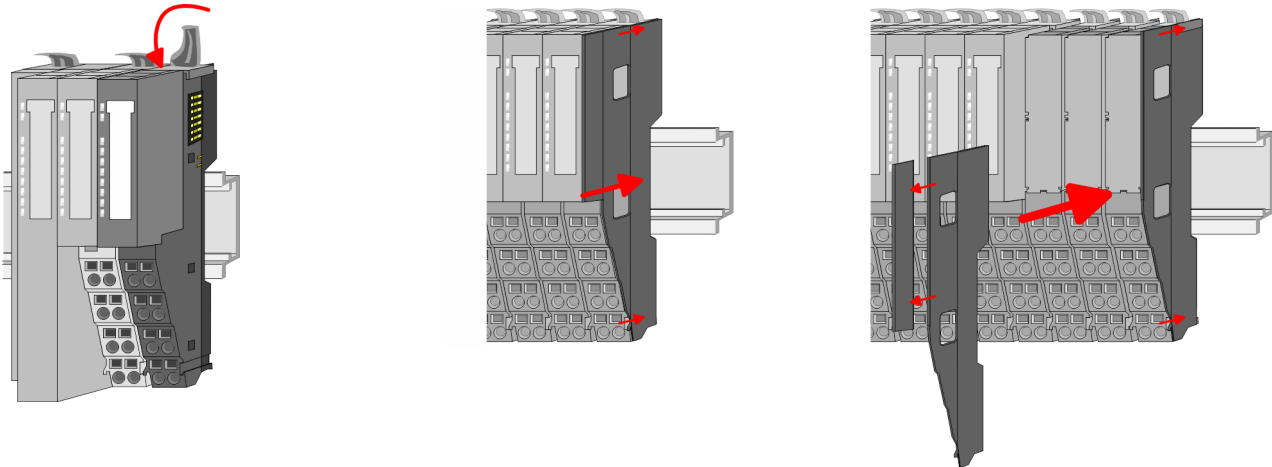

7. After mounting the whole system, to protect the backplane bus connectors at the last module you have to mount the bus cover, now. If the last module is a clamp module, for adaptation the upper part of the bus cover is to be removed.

## 2.5 Mounting 16x periphery modules



**CAUTION!**

**Requirements for UL compliance use**

- Use for power supply exclusively SELV/PELV power supplies.
- The System SLIO must be installed and operated in a housing according to IEC 61010-1 9.3.2 c).

There is a locking lever at the top side of the module. For mounting and demounting this locking lever is to be turned upwards until this engages. For mounting place the module to the module installed before and push the module to the mounting rail guided by the strips at the upper and lower side of the module. The module is fixed to the mounting rail by pushing downward the locking lever. The modules may either separately be mounted to the mounting rail or as block. Here is to be considered that each locking lever is opened. The modules are each installed on a mounting rail. The electronic and power section supply are connected via the backplane bus. Up to 64 modules may be mounted. Please consider here that the sum current of the electronic power supply does not exceed the maximum value of 3A. By means of the power module 007-1AB10 the current of the electronic power supply may be expanded accordingly.

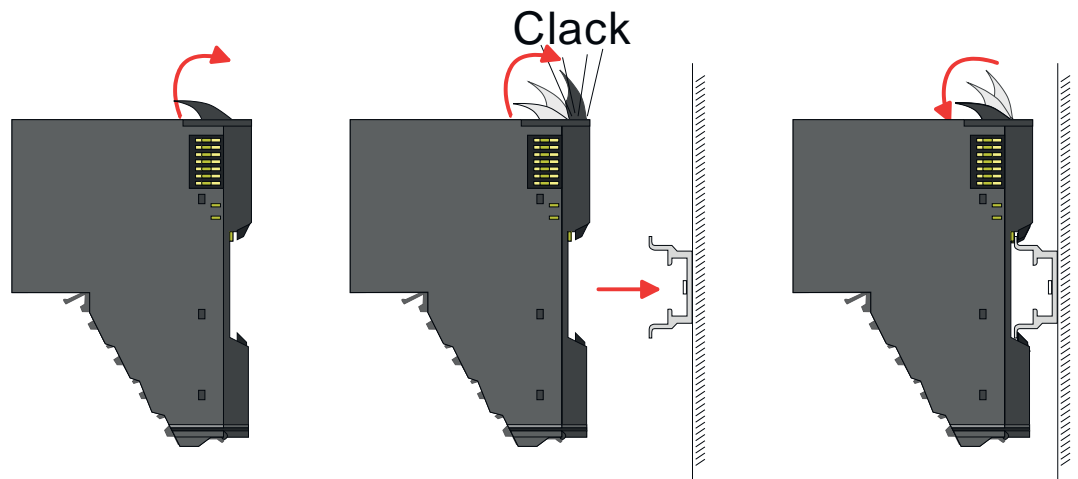

**Electronic unit and terminal block**

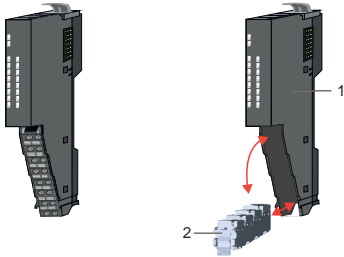

Each 16x periphery module consists of an *electronic unit* and a *terminal block*.

- 1 Electronic unit
- 2 Terminal block

To replace an electronic unit, you can push down and pull off the terminal block after releasing the lock. To mount the terminal block, place it horizontally on the lower side of the electronic unit and push it towards the electronic unit until it clicks into place.

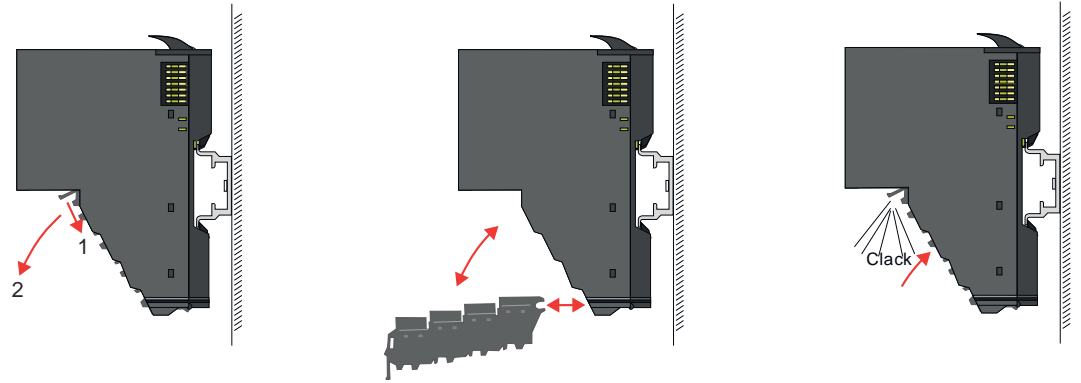

**Mounting periphery module**

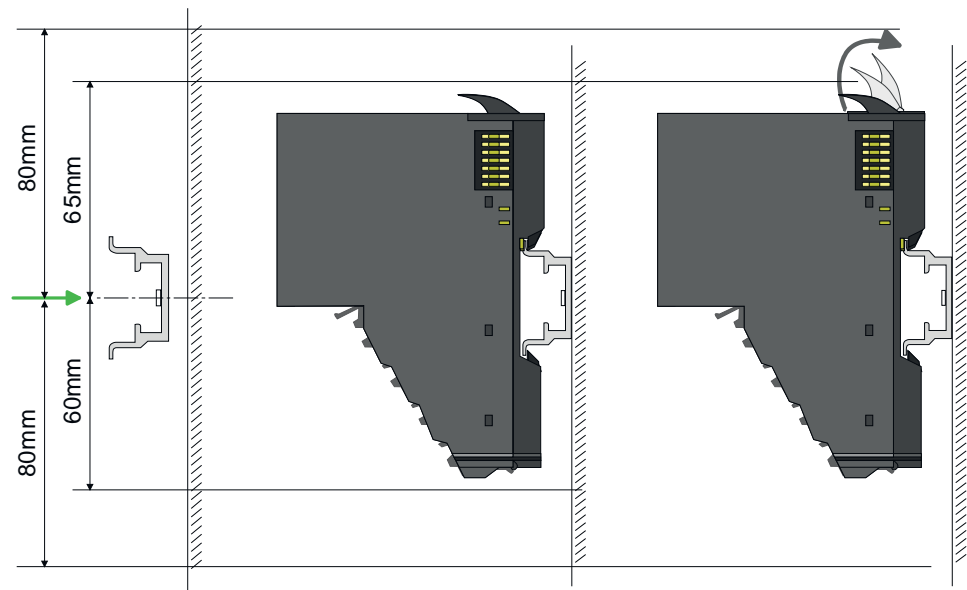

1. ➤ Mount the mounting rail! Please consider that a clearance from the middle of the mounting rail of at least 80mm above and 80mm below exist.
2. ➤ Mount your head module such as CPU or field bus coupler.
3. ➤ Before mounting the periphery modules you have to remove the bus cover at the right side of the head module by pulling it forward. Keep the cover for later mounting.

Wiring 8x periphery modules

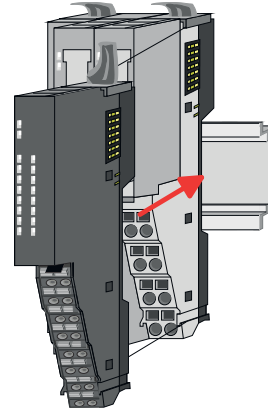
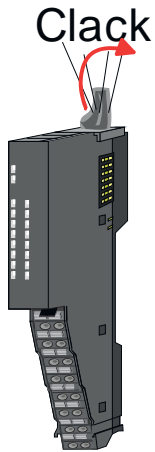

4. For mounting turn the locking lever of the module upwards until it engages.
5. For mounting place the module to the module installed before and push the module to the mounting rail guided by the strips at the upper and lower side of the module.
6. Turn the locking lever of the periphery module downward, again.

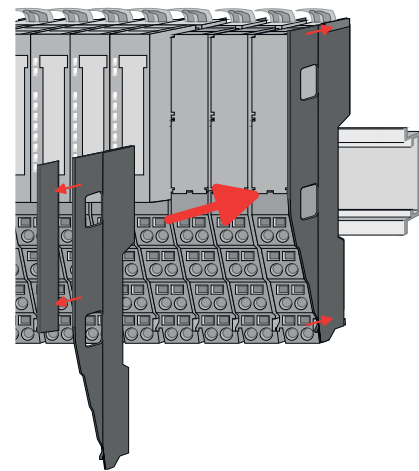
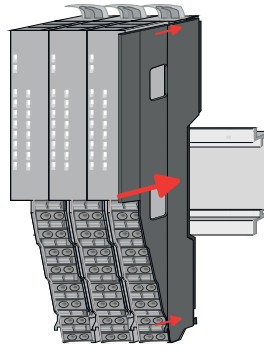
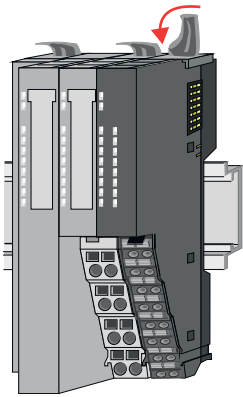

7. After mounting the whole system, to protect the backplane bus connectors at the last module you have to mount the bus cover, now. If the last module is a clamp module, for adaptation the upper part of the bus cover is to be removed.

## 2.6 Wiring 8x periphery modules

### Terminal module terminals



**CAUTION!**

**Do not connect hazardous voltages!**

If this is not explicitly stated in the corresponding module description, hazardous voltages are not allowed to be connected to the corresponding terminal module!

- With wiring the terminal modules, terminals with spring clamp technology are used for wiring. The spring clamp technology allows quick and easy connection of your signal and supply lines. In contrast to screw terminal connections this type of connection is vibration proof.

**Data**

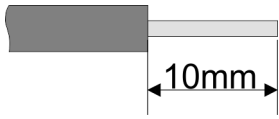

$U_{max}$  240V AC / 30V DC  
 $I_{max}$  10A  
 Cross section 0.08 ... 1.5mm<sup>2</sup> (AWG 28 ... 16)  
 Stripping length 10mm

**Wiring procedure**

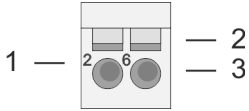

- 1 Pin number at the connector
- 2 Opening for screwdriver
- 3 Connection hole for wire

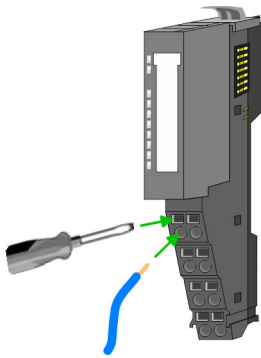
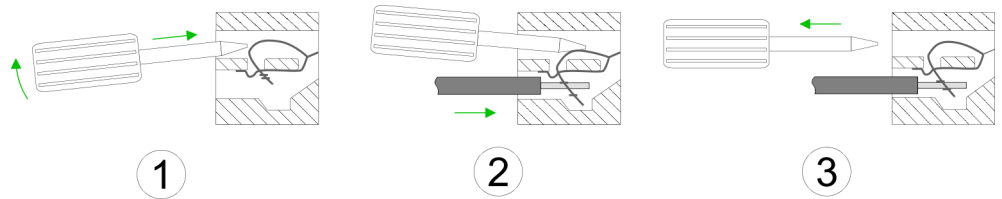

1. Insert a suited screwdriver at an angle into the square opening as shown. Press and hold the screwdriver in the opposite direction to open the contact spring.
2. Insert the stripped end of wire into the round opening. You can use wires with a cross section of 0.08mm<sup>2</sup> up to 1.5mm<sup>2</sup>
3. By removing the screwdriver, the wire is securely fixed via the spring contact to the terminal.

**Shield attachment**

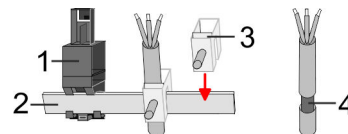

- 1 Shield bus carrier
- 2 Shield bus (10mm x 3mm)
- 3 Shield clamp
- 4 Cable shield

To attach the shield the mounting of shield bus carriers are necessary. The shield bus carrier (available as accessory) serves to carry the shield bus to connect cable shields.

1. Each System SLIO 8x periphery module has a carrier hole for the shield bus carrier. Push the shield bus carrier, until they engage into the module. With a flat mounting rail for adaptation to a flat mounting rail you may remove the spacer of the shield bus carrier.
2. Put your shield bus into the shield bus carrier.

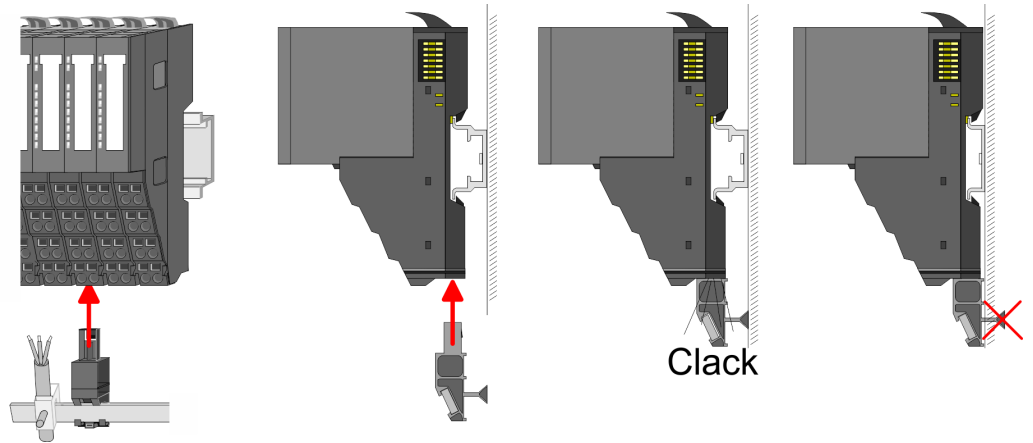

3. Attach the cables with the accordingly stripped cable screen and fix it by the shield clamp with the shield bus.

## 2.7 Wiring 16x periphery modules

### Terminal block connectors



#### CAUTION!

#### Do not connect hazardous voltages!

If this is not explicitly stated in the corresponding module description, hazardous voltages are not allowed to be connected to the corresponding terminal block!

- The 16x periphery module has a removable terminal block for wiring.
- With the wiring of the terminal block a "push-in" spring-clip technique is used. This allows a quick and easy connection of your signal and supply lines.
- The clamping off takes place by means of a screwdriver.
- Please use copper wire only!

### Data

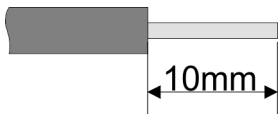

$U_{max}$	30V DC
$I_{max}$	10A
Cross section solid wire	0.25 ... 0.75mm <sup>2</sup>
Cross section with ferrule	0.14 ... 0.75mm <sup>2</sup>
Wire type	CU
AWG	24 ... 16
Stripping length	10mm

### Wiring procedure

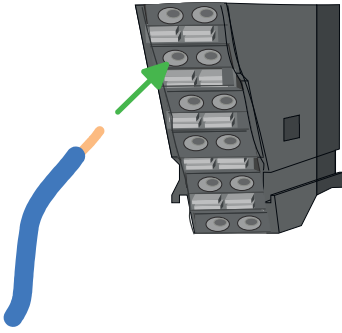

- 1 Release area
- 2 Connection hole for wire

**Insert wire**

The wiring happens without a tool.

1. ➤ Determine according to the casing labelling the connection position.
2. ➤ Insert through the round connection hole of the according contact your prepared wire until it stops, so that it is fixed.
  - ⇒ By pushing the contact spring opens, thus ensuring the necessary contact pressure.

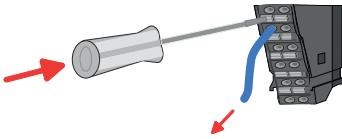
**Remove wire**

The wire is to be removed by means of a screwdriver with 2.5mm blade width.

1. ➤ Press with your screwdriver vertically at the release button.
  - ⇒ The contact spring releases the wire.
2. ➤ Pull the wire from the round hole.

## 2.8 Wiring power modules

**Terminal module terminals**

Power modules are either integrated to the head module or may be installed between the periphery modules. With power modules, terminals with spring clamp technology are used for wiring. The spring clamp technology allows quick and easy connection of your signal and supply lines. In contrast to screw terminal connections this type of connection is vibration proof.

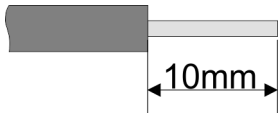
**Data**

$U_{\max}$	30V DC
$I_{\max}$	10A
Cross section	0.08 ... 1.5mm <sup>2</sup> (AWG 28 ... 16)
Stripping length	10mm

Wiring power modules

Wiring procedure

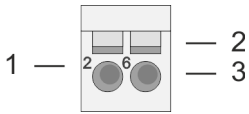

- 1 Pin number at the connector
- 2 Opening for screwdriver
- 3 Connection hole for wire

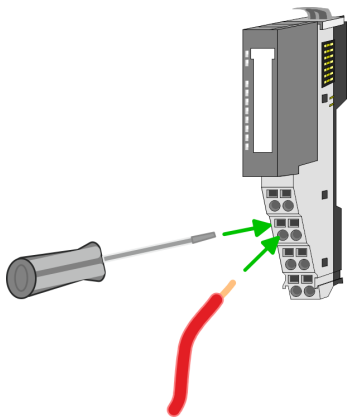
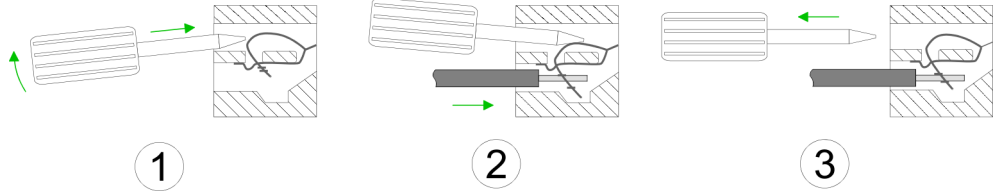

- 1. Insert a suited screwdriver at an angle into the square opening as shown. Press and hold the screwdriver in the opposite direction to open the contact spring.
- 2. Insert the stripped end of wire into the round opening. You can use wires with a cross section of 0.08mm<sup>2</sup> up to 1.5mm<sup>2</sup>
- 3. By removing the screwdriver, the wire is securely fixed via the spring contact to the terminal.

Standard wiring

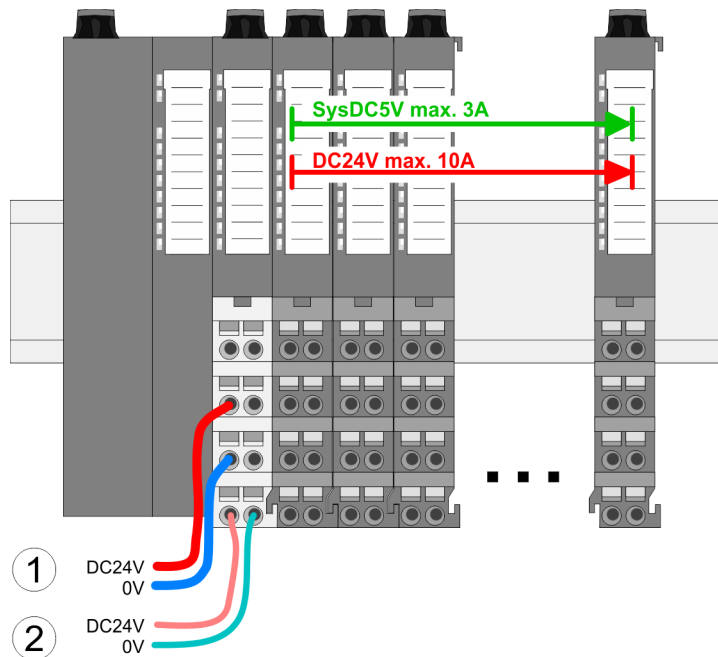

- (1) DC 24V for power section supply I/O area (max. 10A)
- (2) DC 24V for electronic power supply bus coupler and I/O area

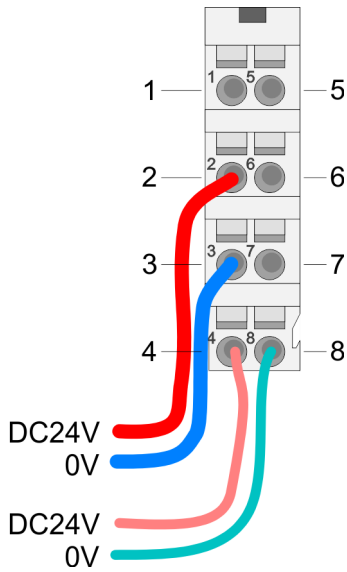

**PM - Power module**

For wires with a core cross-section of 0.08mm<sup>2</sup> up to 1.5mm<sup>2</sup>.

Pos.	Function	Type	Description
1	---	---	not connected
2	DC 24V	I	DC 24V for power section supply
3	0V	I	GND for power section supply
4	Sys DC 24V	I	DC 24V for electronic section supply
5	---	---	not connected
6	DC 24V	I	DC 24V for power section supply
7	0V	I	GND for power section supply
8	Sys 0V	I	GND for electronic section supply

I: Input

**CAUTION!**

Since the power section supply is not internally protected, it is to be externally protected with a fuse, which corresponds to the maximum current. This means max. 10A is to be protected by a 10A fuse (fast) respectively by a line circuit breaker 10A characteristics Z!



*The electronic power section supply is internally protected against higher voltage by fuse. The fuse is within the power module. If the fuse releases, its electronic module must be exchanged!*

**Fusing**

- The power section supply is to be externally protected with a fuse, which corresponds to the maximum current. This means max. 10A is to be protected with a 10A fuse (fast) respectively by a line circuit breaker 10A characteristics Z!
- It is recommended to externally protect the electronic power supply for head modules and I/O area with a 2A fuse (fast) respectively by a line circuit breaker 2A characteristics Z.
- The electronic power supply for the I/O area of the power module 007-1AB10 should also be externally protected with a 1A fuse (fast) respectively by a line circuit breaker 1A characteristics Z.

**State of the electronic power supply via LEDs**

After PowerON of the System SLIO the LEDs RUN respectively MF get on so far as the sum current does not exceed 3A. With a sum current greater than 3A the LEDs may not be activated. Here the power module with the order number 007-1AB10 is to be placed between the peripheral modules.

**Deployment of the power modules**

- If the 10A for the power section supply is no longer sufficient, you may use the power module with the order number 007-1AB00. So you have also the possibility to define isolated groups.
- The power module with the order number 007-1AB10 is to be used if the 3A for the electronic power supply at the backplane bus is no longer sufficient. Additionally you get an isolated group for the DC 24V power section supply with max. 4A.
- By placing the power module 007-1AB10 at the following backplane bus modules may be placed with a sum current of max. 2A. Afterwards a power module is to be placed again. To secure the power supply, the power modules may be mixed used.

**Power module 007-1AB00**

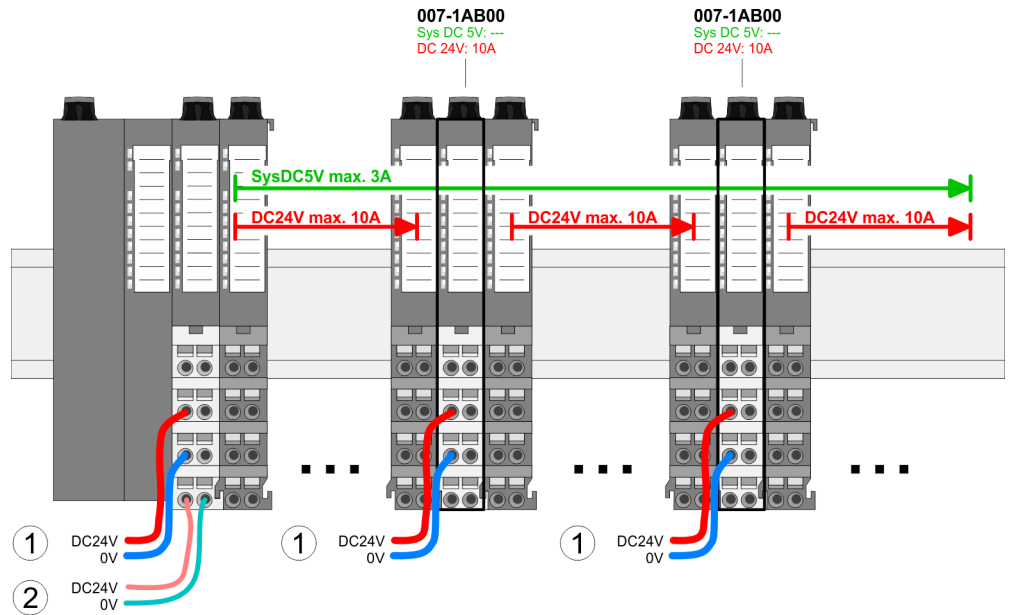

**Power module 007-1AB10**

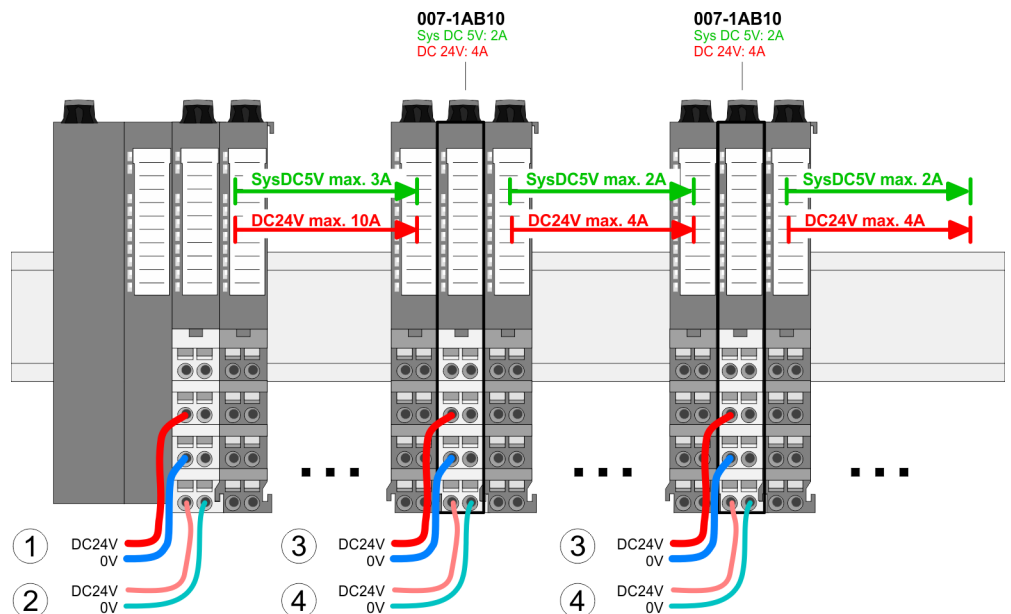

- (1) DC 24V for power section supply I/O area (max. 10A)
- (2) DC 24V for electronic power supply bus coupler and I/O area
- (3) DC 24V for power section supply I/O area (max. 4A)
- (4) DC 24V for electronic power supply I/O area

## Shield attachment

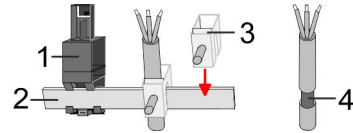

- 1 Shield bus carrier
- 2 Shield bus (10mm x 3mm)
- 3 Shield clamp
- 4 Cable shield

To attach the shield the mounting of shield bus carriers are necessary. The shield bus carrier (available as accessory) serves to carry the shield bus to connect cable shields.

1. ➤ Each System SLIO 8x peripheral module has a carrier hole for the shield bus carrier. Push the shield bus carrier, until they engage into the module. With a flat mounting rail for adaptation to a flat mounting rail you may remove the spacer of the shield bus carrier.
2. ➤ Put your shield bus into the shield bus carrier.

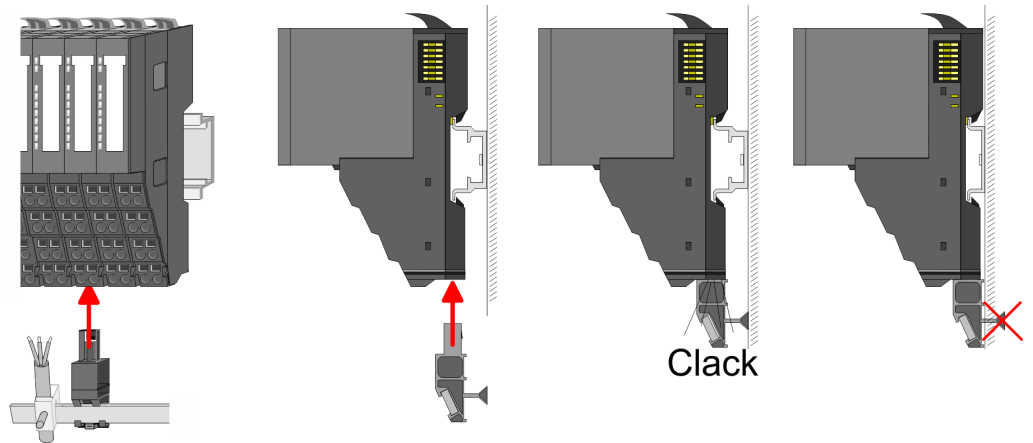

3. ➤ Attach the cables with the accordingly stripped cable screen and fix it by the shield clamp with the shield bus.

## 2.9 Demounting 8x periphery modules

### Proceeding

#### Exchange of an electronic module

1. ➤ Power-off your system.

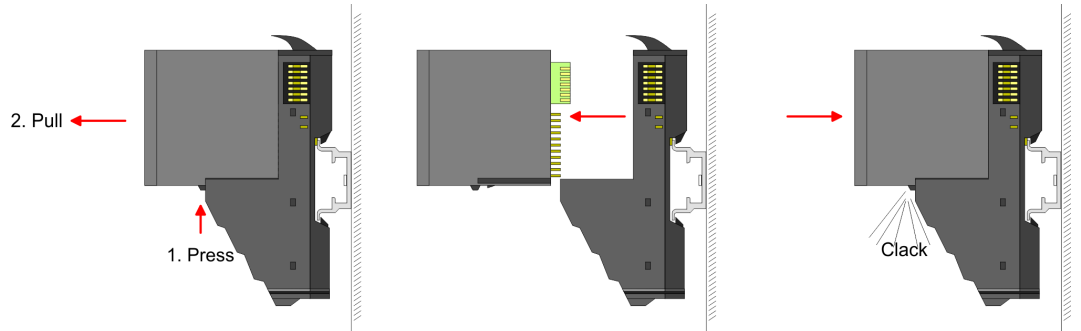

2. ➤ For the exchange of a electronic module, the electronic module may be pulled forward after pressing the unlocking lever at the lower side of the module.
3. ➤ For installation plug the new electronic module guided by the strips at the lower side until this engages to the terminal module.
  - ⇒ Now you can bring your system back into operation.



#### **Easy Maintenance**

'Easy Maintenance' means the support for adding and removing electronic modules during operation without having to restart the system. If this is supported by your head module, you will find more detailed information on this in the "Deployment" chapter. ↪ Chap. 2.11 'Easy Maintenance' page 38

### Exchange of a periphery module

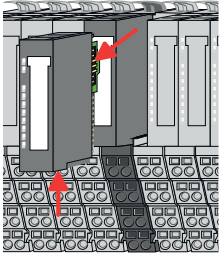

1. ➤ Power-off your system.
2. ➤ Remove if exists the wiring of the module.
3. ➤



*For demounting and exchange of a (head) module or a group of modules, due to mounting reasons you always have to remove the electronic module right beside. After mounting it may be plugged again.*

Press the unlocking lever at the lower side of the just mounted right module and pull it forward.

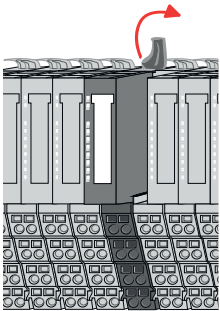

4. ➤ Turn the locking lever of the module to be exchanged upwards.

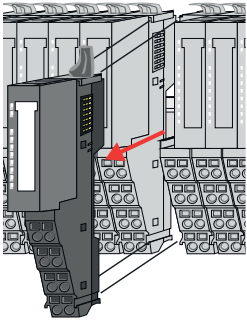

5. ➤ Pull the module.
6. ➤ For mounting turn the locking lever of the module to be mounted upwards.

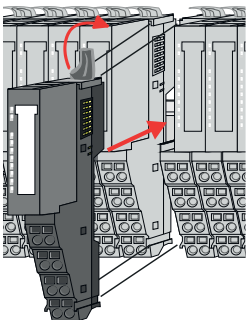

7. ➤ To mount the module put it to the gap between the both modules and push it, guided by the stripes at both sides, to the mounting rail.
8. ➤ Turn the locking lever downward, again.

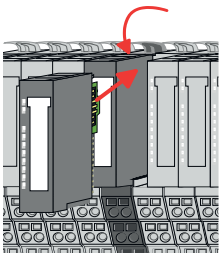

9. ➤ Plug again the electronic module, which you have removed before.
10. ➤ Wire your module.
  - ⇒ Now you can bring your system back into operation.

Demounting 8x periphery modules

**Exchange of a module group**

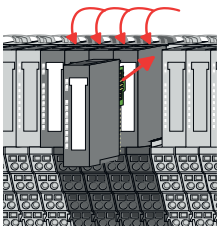
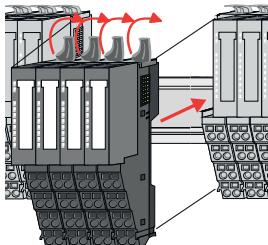
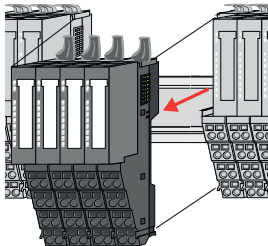
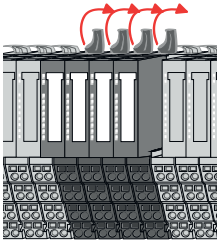
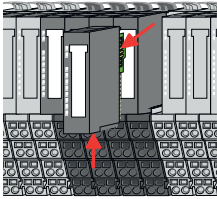

1. ➤ Power-off your system.
2. ➤ Remove if exists the wiring of the module group.

3. ➤

**i** For demounting and exchange of a (head) module or a group of modules, due to mounting reasons you always have to remove the electronic module *right beside*. After mounting it may be plugged again.

Press the unlocking lever at the lower side of the just mounted right module near the module group and pull it forward.

4. ➤ Turn all the locking lever of the module group to be exchanged upwards.

5. ➤ Pull the module group forward.

6. ➤ For mounting turn all the locking lever of the module group to be mounted upwards.

7. ➤ To mount the module group put it to the gap between the both modules and push it, guided by the stripes at both sides, to the mounting rail.

8. ➤ Turn all the locking lever downward, again.

9. ➤ Plug again the electronic module, which you have removed before.

10. ➤ Wire your module group.

⇒ Now you can bring your system back into operation.

## 2.10 Demounting 16x peripheral modules

### Proceeding

#### Exchange of an electronic unit

1. ➤ Power-off your system.
2. ➤ To replace an electronic unit, you can push down and pull off the terminal block after releasing the lock.

To mount the terminal block, place it horizontally on the lower side of the electronic unit and push it towards the electronic unit until it clicks into place.

⇒ Now you can bring your system back into operation.

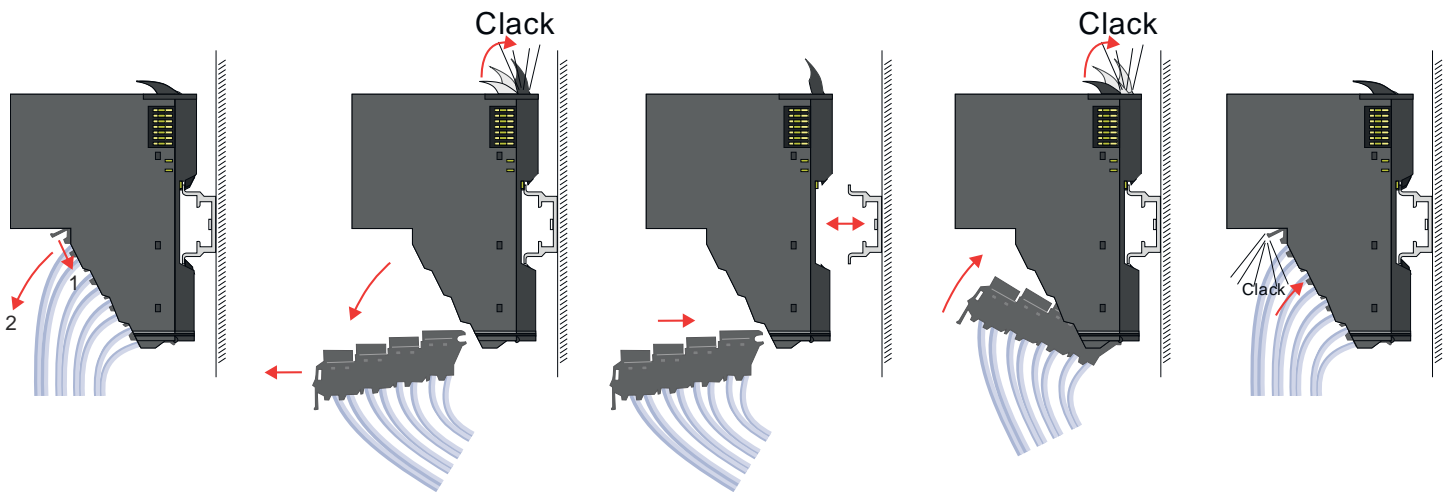

#### Exchange of a 16x peripheral module

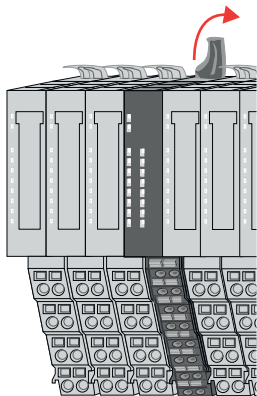

1. ➤ Power-off your system.
2. ➤ Remove if exists the wiring of the module respectively the wired terminal block.
3. ➤



*In contrast to 8x peripheral modules, you can directly demount and mount 16x peripheral modules.*

Turn the locking lever of the module to be exchanged upwards.

Demounting 16x periphery modules

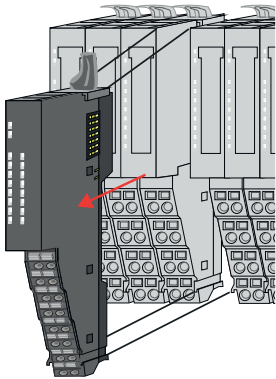

4. ➤ Pull the module.
5. ➤ For mounting turn the locking lever of the module to be mounted upwards.

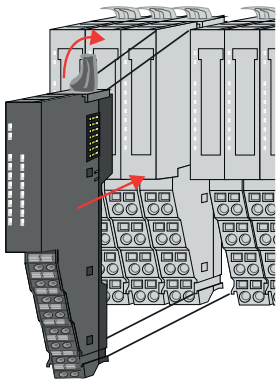

6. ➤ To mount the module put it to the gap between the both modules and push it, guided by the stripes at both sides, to the mounting rail.

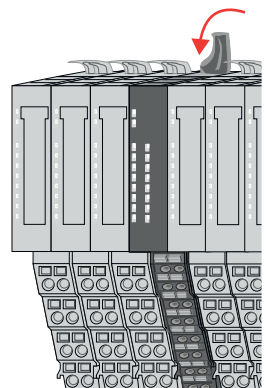

7. ➤ Turn the locking lever downward, again.
8. ➤ Wire your module respectively plug the wired terminal block again.
  - ⇒ Now you can bring your system back into operation.

Exchange of a module group

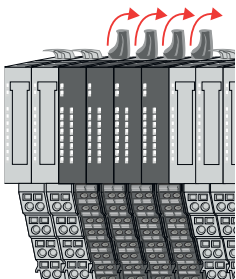

1. ➤ Power-off your system.
2. ➤ Remove if exists the wiring of the module group respectively the wired terminal blocks.
3. ➤

**i** *In contrast to 8x periphery modules, you can directly demount and mount 16x periphery modules.*

Turn all the locking lever of the module group to be exchanged upwards.



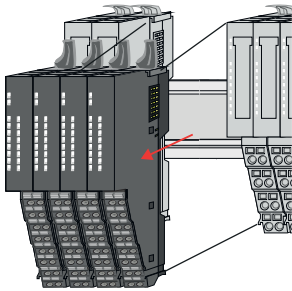

4. ➤ Pull the module group forward.
5. ➤ For mounting turn all the locking lever of the module group to be mounted upwards.

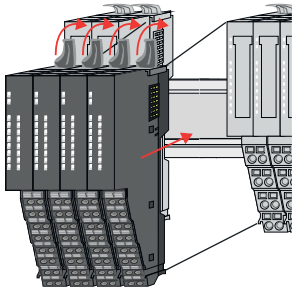

6. ➤ To mount the module group put it to the gap between the both modules and push it, guided by the stripes at both sides, to the mounting rail.

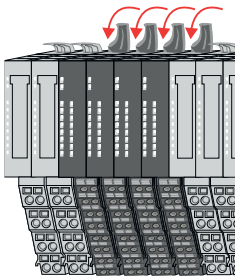

7. ➤ Turn all the locking lever downward, again.
8. ➤ Wire your module group respectively plug the wired terminal blocks again.  
⇒ Now you can bring your system back into operation.

## 2.11 Easy Maintenance

### Overview

*Easy Maintenance* means the support for adding and removing an electronic module during operation without having to restart the system. Here the following behavior is shown by the example of a CPU:

- Electronic module is removed
  - The CPU detects a module failure on the backplane bus.
  - Diagnostic message ‘*System SLIO bus failure*’ (0x39D0) is triggered.
  - OB 86 is called. If this is not available, the CPU switches to STOP otherwise it remains in RUN.
  - The SF LED of the CPU lights up.
  - The I/O data of all modules become invalid.
- Identical electronic module is plugged
  - The CPU detects the module return on the backplane bus.
  - The SF-LED of the CPU gets off.
  - All RUN LEDs on the modules get on and the MF LEDs get off.
  - Diagnostic message ‘*System SLIO bus recovery*’ (0x38D0) is triggered.
  - OB 86 is called. If this is not available, the CPU switches to STOP otherwise it remains in RUN.
  - The I/O data of all modules become valid again.
- Wrong electronic module is plugged
  - The CPU detects the wrong module.
  - Diagnostic message ‘*System SLIO bus recovery, but expected configuration does not match actual configuration*’ (0x38D1) is triggered.
  - The SF LED of the CPU remains on.
  - The MF LED of the wrong module flashes.
  - OB 86 is called. If this is not available, the CPU switches to STOP otherwise it remains in RUN.
  - With the exception of the wrong module, the I/O data of all modules become valid again.



#### CAUTION!

Please note that only electronic modules may be exchanged during operation! Replacing an 8x or 16x periphery module during operation can damage the module and the system!



Please note that the CPU switches to STOP, if there is no OB 86 configured when adding or removing System SLIO modules!

## 2.12 Trouble shooting - LEDs

### General

Each module has the LEDs RUN and MF on its front side. Errors or incorrect modules may be located by means of these LEDs.

In the following illustrations flashing LEDs are marked by ☼.

### Sum current of the electronic power supply exceeded

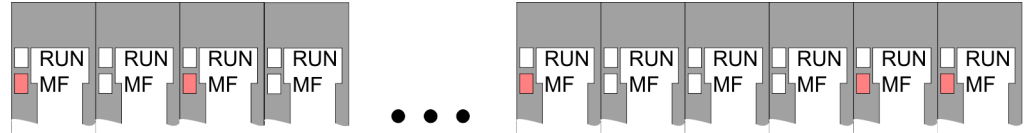

**Behaviour:** After PowerON the RUN LED of each module is off and the MF LED of each module is sporadically on.

**Reason:** The maximum current for the electronic power supply is exceeded.

**Remedy:** As soon as the sum current of the electronic power supply is exceeded, always place the power module 007-1AB10. ↪ Chap. 2.8 'Wiring power modules' page 27

### Error in configuration

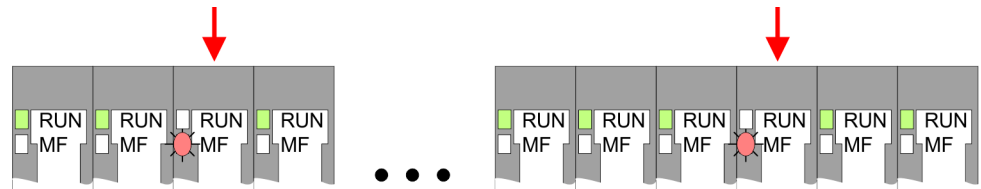

**Behaviour:** After PowerON the MF LED of one module respectively more modules flashes. The RUN LED remains off.

**Reason:** At this position a module is placed, which does not correspond to the configured module.

**Remedy:** Match configuration and hardware structure.

### Module failure

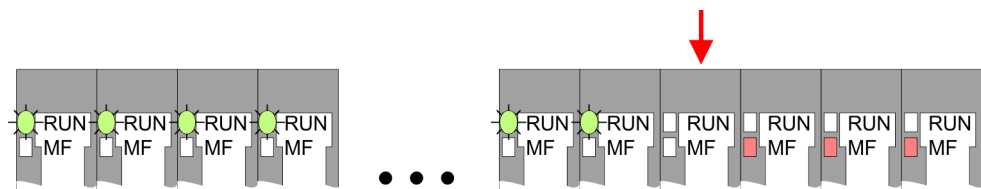

**Behaviour:** After PowerON all of the RUN LEDs up to the defective module are flashing. With all following modules the MF LED is on and the RUN LED is off.

**Reason:** The module on the right of the flashing modules is defective.

**Remedy:** Replace the defective module.

## 2.13 Industrial security and installation guidelines

### 2.13.1 Industrial security in information technology

#### Latest version

This chapter can also be found as a guide '*Industrial IT Security*' at [www.yaskawa.eu.com](http://www.yaskawa.eu.com)

#### Hazards

The topic of data security and access protection has become increasingly important in the industrial environment. The increased networking of entire industrial systems to the network levels within the company together with the functions of remote maintenance have all served to increase vulnerability. Hazards can arise from:

- Internal manipulation such as technical errors, operating and program errors and deliberate program or data manipulation.
- External manipulation such as software viruses, worms and Trojans.
- Human carelessness such as password phishing.

#### Precautions

The most important precautions to prevent manipulation and loss of data security in the industrial environment are:

- Encrypting the data traffic by means of certificates.
- Filtering and inspection of the traffic by means of VPN - "Virtual Private Networks".
- Identification of the user by "Authentication" via safe channels.
- Segmenting in protected automation cells, so that only devices in the same group can exchange data.
- Deactivation of unnecessary hardware and software.

#### Further Information

You can find more information about the measures on the following websites:

- Federal Office for Information Technology [www.bsi.bund.de](http://www.bsi.bund.de)
- Cybersecurity & Infrastructure Security Agency [us-cert.cisa.gov](http://us-cert.cisa.gov)
- VDI / VDE Society for Measurement and Automation Technology [www.vdi.de](http://www.vdi.de)

### 2.13.1.1 Protection of hardware and applications

#### Precautions

- Do not integrate any components or systems into public networks.
  - Use VPN "Virtual Private Networks" for use in public networks. This allows you to control and filter the data traffic accordingly.
- Always keep your system up-to-date.
  - Always use the latest firmware version for all devices.
  - Update your user software regularly.
- Protect your systems with a firewall.
  - The firewall protects your infrastructure internally and externally.
  - This allows you to segment your network and isolate entire areas.
- Secure access to your plants via user accounts.
  - If possible, use a central user management system.
  - Create a user account for each user for whom authorization is essential.
  - Always keep user accounts up-to-date and deactivate unused user accounts.
- Secure access to your plants via secure passwords.
  - Change the password of a standard login after the first start.
  - Use strong passwords consisting of upper/lower case, numbers and special characters. The use of a password generator or manager is recommended.
  - Change the passwords according to the rules and guidelines that apply to your application.
- Deactivate inactive communication ports respectively protocols.
  - Only the communication ports that are used for communication should be activated.
  - Only the communication protocols that are used for communication should be activated.
- Consider possible defence strategies when planning and securing the system.
  - The isolation of components alone is not sufficient for comprehensive protection. An overall concept is to be drawn up here, which also provides defensive measures in the event of a cyber attack.
  - Periodically carry out threat assessments. Among others, a comparison is made here between the protective measures taken and those required.
- Limit the use of external storage media.
  - Via external storage media such as USB memory sticks or SD memory cards, malware can get directly into a system while bypassing a firewall.
  - External storage media or their slots must be protected against unauthorized physical access, e.g. by using a lockable control cabinet.
  - Make sure that only authorized persons have access.
  - When disposing of storage media, make sure that they are safely destroyed.
- Use secure access paths such as HTTPS or VPN for remote access to your plant.
- Enable security-related event logging in accordance with the applicable security policy and legal requirements for data protection.

### 2.13.1.2 Protection of PC-based software

#### Precautions

Since PC-based software is used for programming, configuration and monitoring, it can also be used to manipulate entire systems or individual components. Particular caution is required here!

- Use user accounts on your PC systems.
  - If possible, use a central user management system.
  - Create a user account for each user for whom authorization is essential.
  - Always keep user accounts up-to-date and deactivate unused user accounts.
- Protect your PC systems with secure passwords.
  - Change the password of a standard login after the first start.
  - Use strong passwords consisting of upper/lower case, numbers and special characters. The use of a password generator or manager is recommended.
  - Change the passwords according to the rules and guidelines that apply to your application.
- Enable security-related event logging in accordance with the applicable security policy and legal requirements for data protection.
- Protect your PC systems by security software.
  - Install virus scanners on your PC systems to identify viruses, trojans and other malware.
  - Install software that can detect phishing attacks and actively prevent them.
- Always keep your software up-to-date.
  - Update your operating system regularly.
  - Update your software regularly.
- Make regular backups and store the media at a safe place.
- Regularly restart your PC systems. Only boot from storage media that are protected against manipulation.
- Use encryption systems on your storage media.
- Perform security assessments regularly to reduce the risk of manipulation.
- Use only data and software from approved sources.
- Uninstall software which is not used.
- Disable unused services.
- Activate a password-protected screen lock on your PC systems.
- Always lock your PC systems as soon as you leave your PC workstation.
- Do not click any links that come from unknown sources. If necessary ask, e.g. on e-mails.
- Use secure access paths such as HTTPS or VPN for remote access to your PC system.

### 2.13.2 Installation guidelines

#### General

The installation guidelines contain information about the interference free deployment of a PLC system. There is the description of the ways, interference may occur in your PLC, how you can make sure the electromagnetic compatibility (EMC), and how you manage the isolation.

#### What does EMC mean?

Electromagnetic compatibility (EMC) means the ability of an electrical device, to function error free in an electromagnetic environment without being interfered respectively without interfering the environment.

The components are developed for the deployment in industrial environments and meets high demands on the EMC. Nevertheless you should project an EMC planning before installing the components and take conceivable interference causes into account.

**Possible interference causes**

Electromagnetic interferences may interfere your control via different ways:

- Electromagnetic fields (RF coupling)
- Magnetic fields with power frequency
- Bus system
- Power supply
- Protected earth conductor

Depending on the spreading medium (lead bound or lead free) and the distance to the interference cause, interferences to your control occur by means of different coupling mechanisms.

There are:

- galvanic coupling
- capacitive coupling
- inductive coupling
- radiant coupling

**Basic rules for EMC**

In the most times it is enough to take care of some elementary rules to guarantee the EMC. Please regard the following basic rules when installing your PLC.

- Take care of a correct area-wide grounding of the inactive metal parts when installing your components.
  - Install a central connection between the ground and the protected earth conductor system.
  - Connect all inactive metal extensive and impedance-low.
  - Please try not to use aluminium parts. Aluminium is easily oxidizing and is therefore less suitable for grounding.
- When cabling, take care of the correct line routing.
  - Organize your cabling in line groups (high voltage, current supply, signal and data lines).
  - Always lay your high voltage lines and signal respectively data lines in separate channels or bundles.
  - Route the signal and data lines as near as possible beside ground areas (e.g. suspension bars, metal rails, tin cabinet).
- Proof the correct fixing of the lead isolation.
  - Data lines must be shielded.
  - Analog lines must be shielded. When transmitting signals with small amplitudes the one sided laying of the isolation may be favourable.
  - Cables for frequency inverters, servo and stepper motors must be shielded.
  - Lay the line isolation extensively on an isolation/protected earth conductor rail directly after the cabinet entry and fix the isolation with cable clamps.
  - Make sure that the isolation/protected earth conductor rail is connected impedance-low with the cabinet.
  - Use metallic or metallised plug cases for isolated data lines.
- In special use cases you should appoint special EMC actions.
  - Consider to wire all inductivities with erase links.
  - Please consider luminescent lamps can influence signal lines.
- Create a homogeneous reference potential and ground all electrical operating supplies when possible.
  - Please take care for the targeted employment of the grounding actions. The grounding of the PLC serves for protection and functionality activity.
  - Connect installation parts and cabinets with your PLC in star topology with the isolation/protected earth conductor system. So you avoid ground loops.
  - If there are potential differences between installation parts and cabinets, lay sufficiently dimensioned potential compensation lines.

**Isolation of conductors**

Electrical, magnetically and electromagnetic interference fields are weakened by means of an isolation, one talks of absorption. Via the isolation rail, that is connected conductive with the rack, interference currents are shunt via cable isolation to the ground. Here you have to make sure, that the connection to the protected earth conductor is impedance-low, because otherwise the interference currents may appear as interference cause.

When isolating cables you have to regard the following:

- If possible, use only cables with isolation tangle.
- The hiding power of the isolation should be higher than 80%.
- Normally you should always lay the isolation of cables on both sides. Only by means of the both-sided connection of the isolation you achieve high quality interference suppression in the higher frequency area. Only as exception you may also lay the isolation one-sided. Then you only achieve the absorption of the lower frequencies. A one-sided isolation connection may be convenient, if:
  - the conduction of a potential compensating line is not possible.
  - analog signals (some mV respectively  $\mu\text{A}$ ) are transferred.
  - foil isolations (static isolations) are used.
- With data lines always use metallic or metallised plugs for serial couplings. Fix the isolation of the data line at the plug rack. Do not lay the isolation on the PIN 1 of the plug bar!
- At stationary operation it is convenient to strip the insulated cable interruption free and lay it on the isolation/protected earth conductor line.
- To fix the isolation tangles use cable clamps out of metal. The clamps must clasp the isolation extensively and have well contact.
- Lay the isolation on an isolation rail directly after the entry of the cable in the cabinet. Lead the isolation further on to your PLC and don't lay it on there again!



**CAUTION!**  
**Please regard at installation!**

At potential differences between the grounding points, there may be a compensation current via the isolation connected at both sides.

Remedy: Potential compensation line

**2.14 General data for the System SLIO**

Conformity and approval		
Conformity		
CE	2014/35/EU	Low Voltage Directive
	2014/30/EU	EMC Directive
RoHS (EU)	2011/65/EU	Restriction of the use of certain hazardous substances in electrical and electronic equipment
UKCA	2016 No. 1101	Electrical Equipment (Safety) Regulations
	2016 No. 1091	Electromagnetic Compatibility Regulations
RoHS (UK)	2012 No. 3032	Use of Certain Hazardous Substances
Approval		
UL	-	Refer to Technical data



**Protection of persons and device protection**

Type of protection	-	IP20
Electrical isolation		
to the field bus	-	electrically isolated
to the process level	-	electrically isolated
Insulation resistance	-	-
Insulation voltage to reference earth		
Inputs / outputs	-	AC / DC 50V, test voltage AC 500V
Protective measures	-	against short circuit

**Environmental conditions to EN 61131-2**

Operation		
Horizontal installation hanging	EN 61131-2	0...+60°C
Horizontal installation lying	EN 61131-2	0...+55°C
Vertical installation	EN 61131-2	0...+50°C
Air humidity	EN 60068-2-30	RH1 (without condensation, rel. humidity 10...95%)
Pollution	EN 61131-2	Degree of pollution 2
Installation altitude max.	-	2000m
Mechanical		
Oscillation	EN 60068-2-6	1g, 9Hz ... 150Hz
Shock	EN 60068-2-27	15g, 11ms

**Mounting conditions**

Mounting place	-	In the control cabinet
Mounting position	-	Horizontal and vertical

General data for the System SLIO > Use in difficult operating conditions

EMC	Standard	Comment	
Emitted interference	EN 61000-6-4	Class A (Industrial area)	
Noise immunity zone B	EN 61000-6-2	Industrial area	
		EN 61000-4-2	ESD 8kV at air discharge (degree of severity 3), 4kV at contact discharge (degree of severity 2)
		EN 61000-4-3	HF field immunity (casing) 80MHz ... 1000MHz, 10V/m, 80% AM (1kHz) 1.4GHz ... 6GHz, 3V/m, 80% AM (1kHz)
		EN 61000-4-6	HF conducted 150kHz ... 80MHz, 10V, 80% AM (1kHz)
		EN 61000-4-4	Burst, degree of severity 3
		EN 61000-4-5	Surge, degree of severity 3 <sup>1</sup>

1) Due to the high-energetic single pulses with Surge an appropriate external protective circuit with lightning protection elements like conductors for lightning and overvoltage is necessary.

### 2.14.1 Use in difficult operating conditions



*Without additional protective measures, the products must not be used in locations with difficult operating conditions; e.g. due to:*

- *dust generation*
- *chemically active substances (corrosive vapors or gases)*
- *strong electric or magnetic fields*

## 2.15 System SLIO product variants for extended application range

The System SLIO product variants listed below only differ from the basic modules only in the extended temperature range and the use under condensation. All other data correspond to those of the basic modules. Information on structure and configuration can be found in the manuals for the basic modules in the 'Download Center' of [www.yaskawa.eu.com](http://www.yaskawa.eu.com)



*Please note that the product variants listed here may only be operated in combination with one another on the backplane bus! Mixed operation is not possible!*

Basic modules	Product variants	Description
053-1PN01	053-1PN01-C	IM - 053-1PN01 - interface module PROFINET
021-1BF00	021-1BF00-C	SM 021 - digital input - 8xDI - DC 24V
022-1BF00	022-1BF00-C	SM 022 - digital output - 8xDO - DC 24V 0.5A
031-1CD30	031-1CD30-C	SM 031 - analog input - 4xAI - 16bit 0 ... 10V
031-1BD80	031-1BD80-C	SM 031 - analog input - 4xAI - 16bit R/RTD
032-1CD30	032-1CD30-C	SM 032 - analog output - 4xAI - 16bit 0 ... 10V

### Environmental conditions according to EN 61131-2 for System SLIO basic modules

#### Climatic

Storage / transport	EN 60068-2-14	-25...+70°C
---------------------	---------------	-------------

#### Operation

Horizontal installation hanging	EN 61131-2	0...+60°C
Horizontal installation lying	EN 61131-2	0...+55°C
Vertical installation	EN 61131-2	0...+50°C
Air humidity	EN 60068-2-30	RH1 (without condensation, rel. humidity 10...95%)
Pollution	EN 61131-2	Degree of pollution 2

### Environmental conditions according to EN 61131-2 for System SLIO product variants

#### Climatic

Storage / transport	EN 60068-2-14	-25...+70°C
---------------------	---------------	-------------

#### Operation

Horizontal installation hanging	EN 61131-2	-25 ... + 60 ° C
Horizontal installation lying	EN 61131-2	-25...+55°C
Vertical installation	EN 61131-2	-25 ... + 50 ° C
Air humidity	EN 60068-2-30	RH1 (without condensation, rel. humidity 10...95%)
Climate	GS 95024-3-1:2010	Condensation
Pollution	EN 61131-2	Degree of pollution 2

### 3 Digital input

#### 3.1 021-1BB00 - DI 2xDC 24V

##### Properties

The electronic module collects the binary control signals from the process level and transmits them isolated to the central bus system. It has 2 channels and their status is monitored via LEDs.

- 2 digital inputs, isolated to the backplane bus
- Suited for switches and approximate switches
- Status indication of the channels via LEDs also with de-activated electronic power supply

##### Structure

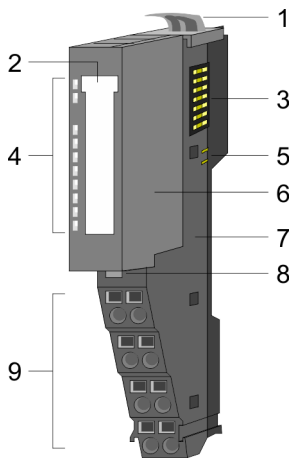

- 1 Locking lever terminal module
- 2 Labeling strip
- 3 Backplane bus
- 4 LED status indication
- 5 DC 24V power section supply
- 6 Electronic module
- 7 Terminal module
- 8 Locking lever electronic module
- 9 Terminal

##### Status indication

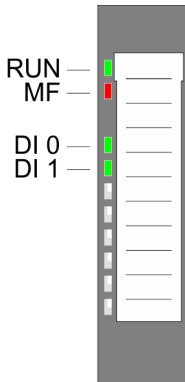

RUN	MF	DI x	Description
<input checked="" type="checkbox"/> green	<input checked="" type="checkbox"/> red	<input checked="" type="checkbox"/> green	
<input checked="" type="checkbox"/>	<input type="checkbox"/>	X	Bus communication is OK Module status is OK
<input checked="" type="checkbox"/>	<input checked="" type="checkbox"/>	X	Bus communication is OK Module status reports an error
<input type="checkbox"/>	<input checked="" type="checkbox"/>	X	Bus communication is not possible Module status reports an error
<input type="checkbox"/>	<input type="checkbox"/>	X	Error at bus power supply
X	<input checked="" type="checkbox"/> 2Hz	X	Flashing: Error in configuration <a href="#">Chap. 2.12 'Trouble shooting - LEDs' page 39</a>
<input checked="" type="checkbox"/>	<input type="checkbox"/>	<input checked="" type="checkbox"/>	Digital input has signal "1"
<input checked="" type="checkbox"/>	<input type="checkbox"/>	<input type="checkbox"/>	Digital input has signal "0"
not relevant: X			

**Pin assignment**

For wires with a cross section of 0.08mm<sup>2</sup> up to 1.5mm<sup>2</sup>.

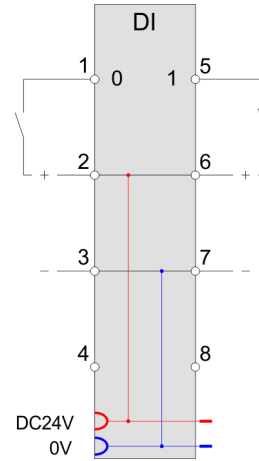
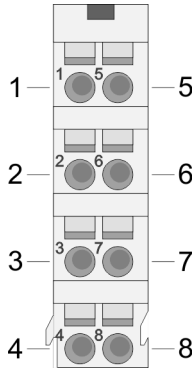

Pos.	Function	Type	Description
1	DI 0	I	Digital input DI 0
2	DC 24V	O	DC 24V for sensor
3	0V	O	GND
4	---	---	not connected
5	DI 1	I	Digital input DI 1
6	DC 24V	O	DC 24V for sensor
7	0V	O	GND
8	---	---	not connected

I: Input, O: Output

**Input area**

At CPU, PROFIBUS and PROFINET the input area is embedded to the corresponding address area.

IX - Index for access via CANopen

SX - Subindex for access via EtherCAT with Index 6000h + EtherCAT-Slot

More can be found in the according manual of your bus coupler.

Addr.	Name	Bytes	Function	IX	SX
+0	PII	1	State of the inputs	5000h	
			Bit 0: DI 0		01h
			Bit 1: DI 1		02h
			Bit 7 ... 2: reserved		

**Output area**

No byte of the output area is used by the module.

## 3.1.1 Technical data

Order no.	021-1BB00
Type	SM 021
Module ID	0001 9F82
<b>Current consumption/power loss</b>	
Current consumption from backplane bus	65 mA
Power loss	0.5 W
<b>Technical data digital inputs</b>	
Number of inputs	2
Cable length, shielded	1000 m
Cable length, unshielded	600 m
Rated load voltage	-
Current consumption from load voltage L+ (without load)	-
Rated value	DC 20.4...28.8 V
Input voltage for signal "0"	DC 0...5 V
Input voltage for signal "1"	DC 15...28.8 V
Input voltage hysteresis	-
Signal logic input	Sinking input
Frequency range	-
Input resistance	-
Input capacitance	-
Input current for signal "1"	3 mA
Connection of Two-Wire-BEROs possible	✓
Max. permissible BERO quiescent current	0.5 mA
Input delay of "0" to "1"	3 ms
Input delay of "1" to "0"	3 ms
Number of simultaneously utilizable inputs horizontal configuration	2
Number of simultaneously utilizable inputs vertical configuration	2
Input characteristic curve	IEC 61131-2, type 1
Initial data size	2 Bit
<b>Status information, alarms, diagnostics</b>	
Status display	green LED per channel
Interrupts	no
Process alarm	no
Diagnostic interrupt	no
Diagnostic functions	no

Order no.	021-1BB00
Diagnostics information read-out	none
Module state	green LED
Module error display	red LED
Channel error display	none
<b>Isolation</b>	
Between channels	-
Between channels of groups to	-
Between channels and backplane bus	✓
Insulation tested with	DC 500 V
<b>Safety</b>	
Safety protocol	-
Safety requirements	-
Secure user address	-
Watchdog	-
Two channels	-
Test pulse outputs	-
<b>Datasizes</b>	
Input bytes	1
Output bytes	0
Parameter bytes	0
Diagnostic bytes	0
<b>Housing</b>	
Material	PPE / PPE GF10
Mounting	Profile rail 35 mm
<b>Mechanical data</b>	
Dimensions (WxHxD)	12.9 mm x 109 mm x 76.5 mm
Net weight	57 g
Weight including accessories	57 g
Gross weight	72 g
<b>Environmental conditions</b>	
Operating temperature	0 °C to 60 °C
Storage temperature	-25 °C to 70 °C
<b>Certifications</b>	
UL certification	yes
KC certification	yes

### 3.2 021-1BB10 - DI 2xDC 24V 2µs...3ms

#### Properties

The electronic module collects the binary control signals from the process level and transmits them isolated to the central bus system. The module has 2 fast digital input channels and their status is monitored via LEDs.

- 2 fast digital inputs, isolated to the backplane bus
- Suited for switches and approximate switches
- Status indication of the channels via LEDs also with de-activated electronic power supply
- Parameterizable input delay
- Interrupt and diagnostics function

#### Structure

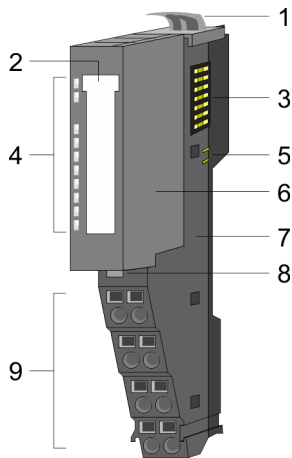

- 1 Locking lever terminal module
- 2 Labeling strip
- 3 Backplane bus
- 4 LED status indication
- 5 DC 24V power section supply
- 6 Electronic module
- 7 Terminal module
- 8 Locking lever electronic module
- 9 Terminal

#### Status indication

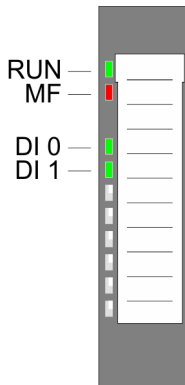

RUN	MF	DI x	Description
<input checked="" type="checkbox"/> green	<input checked="" type="checkbox"/> red	<input checked="" type="checkbox"/> green	
<input checked="" type="checkbox"/>	<input type="checkbox"/>	X	Bus communication is OK Module status is OK
<input checked="" type="checkbox"/>	<input checked="" type="checkbox"/>	X	Bus communication is OK Module status reports an error
<input type="checkbox"/>	<input checked="" type="checkbox"/>	X	Bus communication is not possible Module status reports an error
<input type="checkbox"/>	<input type="checkbox"/>	X	Error at bus power supply
X	<input checked="" type="checkbox"/> 2Hz	X	Flashing: Error in configuration <i>↳ Chap. 2.12 'Trouble shooting - LEDs' page 39</i>
<input checked="" type="checkbox"/>	<input type="checkbox"/>	<input checked="" type="checkbox"/>	Digital input has signal "1"
<input checked="" type="checkbox"/>	<input type="checkbox"/>	<input type="checkbox"/>	Digital input has signal "0"
not relevant: X			



**Pin assignment**

For wires with a cross section of 0.08mm<sup>2</sup> up to 1.5mm<sup>2</sup>.

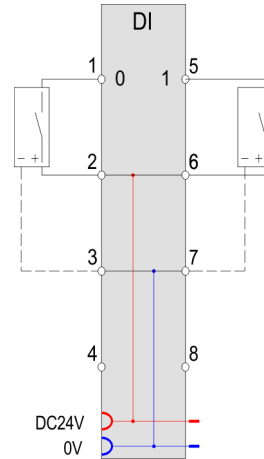
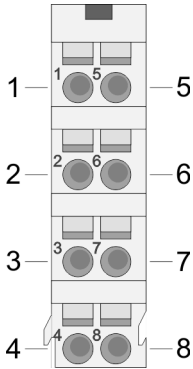

Pos.	Function	Type	Description
1	DI 0	I	Digital input DI 0
2	DC 24V	O	DC 24V for sensor
3	0V	O	GND
4	—	—	not connected
5	DI 1	I	Digital input DI 1
6	DC 24V	O	DC 24V for sensor
7	0V	O	GND
8	—	—	not connected

I: Input, O: Output

**Input area**

At CPU, PROFIBUS and PROFINET the input area is embedded to the corresponding address area.

IX - Index for access via CANopen

SX - Subindex for access via EtherCAT with Index 6000h + EtherCAT-Slot

More can be found in the according manual of your bus coupler.

Addr.	Name	Bytes	Function	IX	SX
+0	PII	1	State of the inputs	5000h	
			Bit 0: DI 0		01h
			Bit 1: DI 1		02h
			Bit 7 ... 2: reserved		

**Output area**

No byte of the output area is used by the module.

## 3.2.1 Technical data

Order no.	021-1BB10
Type	SM 021
Module ID	000A 1F02
<b>Current consumption/power loss</b>	
Current consumption from backplane bus	100 mA
Power loss	0.9 W
<b>Technical data digital inputs</b>	
Number of inputs	2
Cable length, shielded	1000 m
Cable length, unshielded	600 m
Rated load voltage	DC 20.4...28.8 V
Current consumption from load voltage L+ (without load)	12 mA
Rated value	DC 20.4...28.8 V
Input voltage for signal "0"	DC 0...5 V
Input voltage for signal "1"	DC 15...28.8 V
Input voltage hysteresis	-
Signal logic input	Sinking input
Frequency range	-
Input resistance	-
Input capacitance	-
Input current for signal "1"	3 mA
Connection of Two-Wire-BEROs possible	✓
Max. permissible BERO quiescent current	0.5 mA
Input delay of "0" to "1"	parameterizable 2µs - 3ms
Input delay of "1" to "0"	parameterizable 2µs - 3ms
Number of simultaneously utilizable inputs horizontal configuration	2
Number of simultaneously utilizable inputs vertical configuration	2
Input characteristic curve	IEC 61131-2, type 1
Initial data size	2 Bit
<b>Status information, alarms, diagnostics</b>	
Status display	green LED per channel
Interrupts	yes, parameterizable
Process alarm	yes, parameterizable
Diagnostic interrupt	yes, parameterizable
Diagnostic functions	yes

Order no.	021-1BB10
Diagnostics information read-out	possible
Module state	green LED
Module error display	red LED
Channel error display	none
<b>Isolation</b>	
Between channels	-
Between channels of groups to	-
Between channels and backplane bus	✓
Insulation tested with	DC 500 V
<b>Safety</b>	
Safety protocol	-
Safety requirements	-
Secure user address	-
Watchdog	-
Two channels	-
Test pulse outputs	-
<b>Datasizes</b>	
Input bytes	1
Output bytes	0
Parameter bytes	9
Diagnostic bytes	20
<b>Housing</b>	
Material	PPE / PPE GF10
Mounting	Profile rail 35 mm
<b>Mechanical data</b>	
Dimensions (WxHxD)	12.9 mm x 109 mm x 76.5 mm
Net weight	58 g
Weight including accessories	58 g
Gross weight	73 g
<b>Environmental conditions</b>	
Operating temperature	0 °C to 60 °C
Storage temperature	-25 °C to 70 °C
<b>Certifications</b>	
UL certification	yes
KC certification	yes

### 3.2.2 Parameter data

DS - Record set for access via CPU, PROFIBUS and PROFINET

IX - Index for access via CANopen

SX - Subindex for access via EtherCAT with Index 3100h + EtherCAT-Slot

More can be found in the according manual of your bus coupler.

Name	Bytes	Function	Default	DS	IX	SX
DIAG_EN	1	Diagnostic interrupt <sup>1)</sup>	00h	00h	3100h	01h
CH0D	1	Input delay DI 0	02h	01h	3101h	02h
CH1D	1	Input delay DI 1	02h	01h	3102h	03h
INTRE	1	Process interrupt at edge 0-1 of DI x	00h	80h	3103h	04h
INTFE	1	Process interrupt at edge 1-0 of DI x	00h	80h	3104h	05h

1) This record set may only be transferred at STOP state.

#### DIAG\_EN Diagnostic interrupt

Byte	Bit 7 ... 0
0	Diagnostic interrupt 00h: disable 40h: enable

- Here you activate res. de-activate the diagnostic function.

#### CHxD Input delay

Byte	Function	Possible values
0	Input delay DI x	00h: 2µs      07h: 86µs 02h: 4µs      09h: 342µs 04h: 12µs     0Ch: 2731µs
Other values are not permissible!		

- *Input delay* allows you to preset a filter for the corresponding channel. With the help of filters you may e.g. filter signal peaks at a blurred input signal.

#### INTRE Interrupt edge 0-1

Byte	Bit 7 ... 0
0	Bit 0: Process interrupt at edge 0-1 of DI 0 Bit 1: Process interrupt at edge 0-1 of DI 1 (0: disable, 1: enable) Bit 7 ... 2: reserved

**INTFE Interrupt edge 1-0**

Byte	Bit 7 ... 0
0	Bit 0: Process interrupt at edge 1-0 of DI 0 Bit 1: Process interrupt at edge 1-0 of DI 1 (0: disable, 1: enable) Bit 7 ... 2: reserved

**3.2.3 Diagnostics and interrupt**

Event	Process interrupt	Diagnostics interrupt	parameterizable
Edge 0-1 DI x	X	-	X
Edge 1-0 DI x	X	-	X
Diagnostics buffer overflow	-	X	-
Process interrupt lost	-	X	-

**Hardware interrupt**

So you may react to asynchronous events, there is the possibility to activate a hardware interrupt.

- A hardware interrupt interrupts the linear program sequence and jumps depending on the master system to a corresponding Interrupt routine. Here you can react to the hardware interrupt accordingly.
- With CANopen the hardware interrupt data is transferred via an emergency telegram.
- Operating with CPU, PROFIBUS and PROFINET the hardware interrupt data were transferred via diagnostics telegram.

SX - Subindex for access via EtherCAT with Index 5000h

More can be found in the according manual of your bus coupler.

Name	Bytes	Function	Default	SX
PRIT_A	1	Process interrupt data	00h	02h
PRIT_B	1	State of the inputs	00h	03h
PRIT_US	2	µs ticker	00h	04h (high byte) 05h (low byte)

**PRIT\_A Process interrupt data**

Byte	Bit 7 ... 0
0	Bit 0: Edge at Digital input DI 0 Bit 1: Edge at Digital input DI 1 Bit 7 ... 2: reserved

**PRIT\_B State of the inputs**

Byte	Bit 7 ... 0
0	State of the inputs at the moment of the process interrupt Bit 0: State Input DI 0 Bit 1: State Input DI 1 Bit 7 ... 2: reserved

**PRIT\_US µs-Ticker**

Byte	Bit 7 ... 0
0 ... 1	Value of the µs ticker at the moment of the process interrupt

*µs ticker*

In the System SLIO module there is a 32 bit timer (µs ticker). With PowerON the timer starts counting with 0. After  $2^{32}-1\mu\text{s}$  the timer starts with 0 again.

PRIT\_US represents the lower 2 byte of the µs ticker value ( $0 \dots 2^{16}-1$ ).

**Diagnostic data**

Via the parameterization you may activate a diagnostic interrupt for the module.

With a diagnostics interrupt the module serves for diagnostics data for diagnostic interrupt incoming.

As soon as the reason for releasing a diagnostic interrupt is no longer present, the diagnostic interrupt going automatically takes place.

All events of a channel between diagnostic interrupt incoming and diagnostic interrupt going are not stored and get lost.

Within this time window (1. diagnostic interrupt incoming until last diagnostic interrupt going) the MF-LED of the module is on.

DS - Record set for access via CPU, PROFIBUS and PROFINET. The access happens by DS 01h. Additionally the first 4 bytes may be accessed by DS 00h.

IX - Index for access via CANopen. The access happens by IX 2F01h. Additionally the first 4 bytes may be accessed by IX 2F00h.

SX - Subindex for access via EtherCAT with Index 5005h.

More can be found in the according manual of your bus coupler.

Name	Bytes	Function	Default	DS	IX	SX
ERR_A	1	Diagnostic	00h	01h	2F01h	02h
MODTYP	1	Module information	1Fh			03h
ERR_C	1	reserved	00h			04h
ERR_D	1	Diagnostic	00h			05h
CHTYP	1	Channel type	70h			06h
NUMBIT	1	Number of diagnostics bits per channel	00h			07h
NUMCH	1	Number channels of the module	02h			08h
CHERR	1	Channel error	00h			09h
CH0ERR... CH7ERR	8	reserved	00h			0Ah ... 11h
DIAG_US	4	µs ticker	00h			13h

**ERR\_A Diagnostic**

Byte	Bit 7 ... 0
0	Bit 0: set at module failure Bit 1: reserved Bit 2: set at external error Bit 3: set at channel error Bit 7 ... 4: reserved

**MODTYP Module information**

Byte	Bit 7 ... 0
0	Bit 3 ... 0: Module class 1111b Digital module Bit 4: Channel information present Bit 7 ... 5: reserved

**ERR\_C reserved**

Byte	Bit 7 ... 0
0	reserved

**ERR\_D Diagnostic**

Byte	Bit 7 ... 0
0	Bit 2 ... 0: reserved Bit 3: set at internal diagnostics buffer overflow Bit 5 ... 4: reserved Bit 6: Process interrupt lost Bit 7: reserved

**CHTYP Channel type**

Byte	Bit 7 ... 0
0	Bit 6 ... 0: Channel type 70h: Digital input Bit 7: reserved

**NUMBIT Diagnostic bits**

Byte	Bit 7 ... 0
0	Number of diagnostics bits of the module per channel (here 00h)

**NUMCH Channels**

Byte	Bit 7 ... 0
0	Number of channels of the module (here 02h)

**CHERR Channel error**

Byte	Bit 7 ... 0
0	Bit 0: Edge lost at DI 0 Bit 1: Edge lost at DI 1 Bit 7 ... 2: reserved

**CHxERR reserved**

Byte	Bit 7 ... 0
0	reserved

**DIAG\_US µs ticker**

Byte	Bit 7 ... 0
0 ... 3	Value of the µs ticker at the moment of the diagnostic

*µs ticker*

In the System SLIO module there is a 32 bit timer (µs ticker). With PowerON the timer starts counting with 0. After  $2^{32}-1\mu\text{s}$  the timer starts with 0 again.



### 3.3 021-1BB50 - DI 2xDC 24V NPN

#### Properties

The electronic module collects the binary control signals from the process level and transmits them isolated to the central bus system. It has 2 channels and their status is monitored via LEDs. An input becomes active as soon as it is connected to ground.

- 2 digital inputs (Sourcing input), isolated to the backplane bus
- Suited for switches and approximate switches
- Status indication of the channels via LEDs also with de-activated electronic power supply

#### Structure

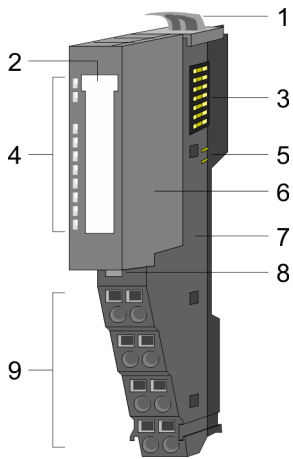

- 1 Locking lever terminal module
- 2 Labeling strip
- 3 Backplane bus
- 4 LED status indication
- 5 DC 24V power section supply
- 6 Electronic module
- 7 Terminal module
- 8 Locking lever electronic module
- 9 Terminal

#### Status indication

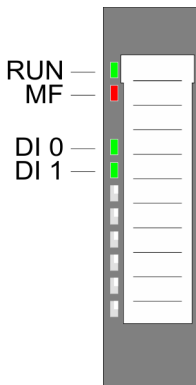

RUN	MF	DI x	Description
<input checked="" type="checkbox"/> green	<input checked="" type="checkbox"/> red	<input checked="" type="checkbox"/> green	
<input checked="" type="checkbox"/>	<input type="checkbox"/>	X	Bus communication is OK Module status is OK
<input checked="" type="checkbox"/>	<input checked="" type="checkbox"/>	X	Bus communication is OK Module status reports an error
<input type="checkbox"/>	<input checked="" type="checkbox"/>	X	Bus communication is not possible Module status reports an error
<input type="checkbox"/>	<input type="checkbox"/>	X	Error at bus power supply
X	<input checked="" type="checkbox"/> 2Hz	X	Flashing: Error in configuration <a href="#">Chap. 2.12 'Trouble shooting - LEDs' page 39</a>
<input checked="" type="checkbox"/>	<input type="checkbox"/>	<input checked="" type="checkbox"/>	Digital input has signal "1"
<input checked="" type="checkbox"/>	<input type="checkbox"/>	<input type="checkbox"/>	Digital input has signal "0"
not relevant: X			

**Pin assignment**

For wires with a cross section of 0.08mm<sup>2</sup> up to 1.5mm<sup>2</sup>.

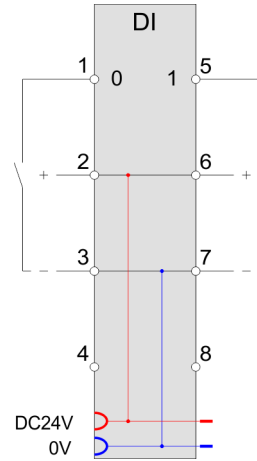
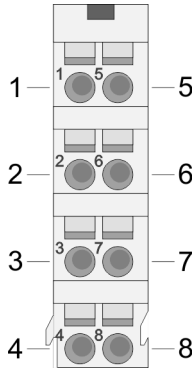

Pos.	Function	Type	Description
1	DI 0	I	Digital input DI 0
2	DC 24V	O	DC 24V for sensor
3	0V	O	GND
4	---	---	not connected
5	DI 1	I	Digital input DI 1
6	DC 24V	O	DC 24V for sensor
7	0V	O	GND
8	---	---	not connected

I: Input, O: Output

**Input area**

At CPU, PROFIBUS and PROFINET the input area is embedded to the corresponding address area.

IX - Index for access via CANopen

SX - Subindex for access via EtherCAT with Index 6000h + EtherCAT-Slot

More can be found in the according manual of your bus coupler.

Addr.	Name	Bytes	Function	IX	SX
+0	PII	1	State of the inputs	5000h	
			Bit 0: DI 0		01h
			Bit 1: DI 1		02h
			Bit 7 ... 2: reserved		

**Output area**

No byte of the output area is used by the module.

## 3.3.1 Technical data

Order no.	021-1BB50
Type	SM 021
Module ID	0002 9F82
<b>Current consumption/power loss</b>	
Current consumption from backplane bus	65 mA
Power loss	0.5 W
<b>Technical data digital inputs</b>	
Number of inputs	2
Cable length, shielded	1000 m
Cable length, unshielded	600 m
Rated load voltage	-
Current consumption from load voltage L+ (without load)	-
Rated value	DC 20.4...28.8 V
Input voltage for signal "0"	DC 15...28.8 V
Input voltage for signal "1"	DC 0...5 V
Input voltage hysteresis	-
Signal logic input	Sourcing input
Frequency range	-
Input resistance	-
Input current for signal "1"	3 mA
Connection of Two-Wire-BEROs possible	✓
Max. permissible BERO quiescent current	0.5 mA
Input delay of "0" to "1"	3 ms
Input delay of "1" to "0"	3 ms
Number of simultaneously utilizable inputs horizontal configuration	2
Number of simultaneously utilizable inputs vertical configuration	2
Input characteristic curve	-
Initial data size	2 Bit
<b>Status information, alarms, diagnostics</b>	
Status display	green LED per channel
Interrupts	no
Process alarm	no
Diagnostic interrupt	no
Diagnostic functions	no
Diagnostics information read-out	none

Order no.	021-1BB50
Module state	green LED
Module error display	red LED
Channel error display	none
<b>Isolation</b>	
Between channels	-
Between channels of groups to	-
Between channels and backplane bus	✓
Insulation tested with	DC 500 V
<b>Safety</b>	
Safety protocol	-
Safety requirements	-
Secure user address	-
Watchdog	-
Two channels	-
Test pulse outputs	-
<b>Datasizes</b>	
Input bytes	1
Output bytes	0
Parameter bytes	0
Diagnostic bytes	0
<b>Housing</b>	
Material	PPE / PPE GF10
Mounting	Profile rail 35 mm
<b>Mechanical data</b>	
Dimensions (WxHxD)	12.9 mm x 109 mm x 76.5 mm
Net weight	57 g
Weight including accessories	57 g
Gross weight	72 g
<b>Environmental conditions</b>	
Operating temperature	0 °C to 60 °C
Storage temperature	-25 °C to 70 °C
<b>Certifications</b>	
UL certification	yes
KC certification	yes

### 3.4 021-1BB70 - DI 2xDC 24V ETS

#### Properties

The electronic module collects the binary control signals from the process level and transmits them isolated to the central bus system. It has 2 channels and their status is monitored via LEDs. With configured ETS functionality (ETS = edge time stamp) and the corresponding (rising/falling) edge the current time value of the System SLIO  $\mu$ s timer is stored together with the state of the inputs in the process image. Depending on the configuration 5 (20byte) respectively 15 (60byte) ETS entries may be stored in the process image one after another.

- 2 digital inputs, isolated to the backplane bus
- Configurable ETS functionality for 5 respectively 15 ETS entries (each 4byte)
- Diagnostics function
- Suited for switches and approximate switches
- Status indication of the channels via LEDs also with de-activated electronic power supply

#### Structure

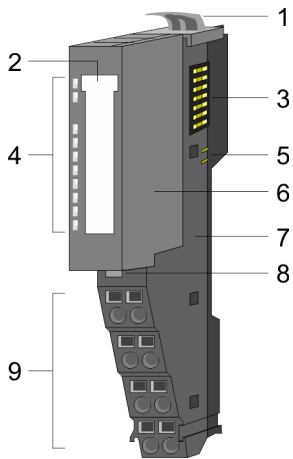

- 1 Locking lever terminal module
- 2 Labeling strip
- 3 Backplane bus
- 4 LED status indication
- 5 DC 24V power section supply
- 6 Electronic module
- 7 Terminal module
- 8 Locking lever electronic module
- 9 Terminal

#### Status indication

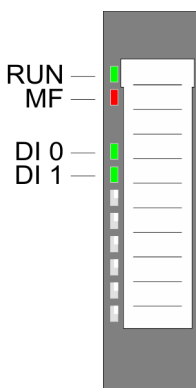

RUN	MF	DI x	Description
<input checked="" type="checkbox"/> green	<input checked="" type="checkbox"/> red	<input checked="" type="checkbox"/> green	
<input checked="" type="checkbox"/>	<input type="checkbox"/>	X	Bus communication is OK Module status is OK
<input checked="" type="checkbox"/>	<input checked="" type="checkbox"/>	X	Bus communication is OK Module status reports an error
<input type="checkbox"/>	<input checked="" type="checkbox"/>	X	Bus communication is not possible Module status reports an error
<input type="checkbox"/>	<input type="checkbox"/>	X	Error at bus power supply
X	<input checked="" type="checkbox"/> 2Hz	X	Flashing: Error in configuration <i>Chap. 2.12 'Trouble shooting - LEDs' page 39</i>
<input checked="" type="checkbox"/>	<input type="checkbox"/>	<input checked="" type="checkbox"/>	Digital input has signal "1"
<input checked="" type="checkbox"/>	<input type="checkbox"/>	<input type="checkbox"/>	Digital input has signal "0"
not relevant: X			

**Pin assignment**

For wires with a cross section of 0.08mm<sup>2</sup> up to 1.5mm<sup>2</sup>.

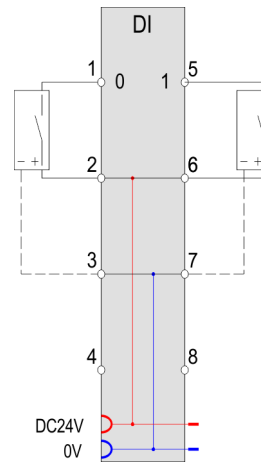
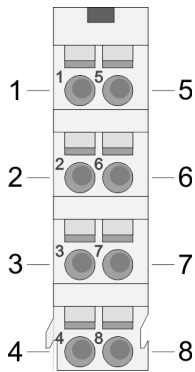

Pos.	Function	Type	Description
1	DI 0	I	Digital input DI 0
2	DC 24V	O	DC 24V for sensor
3	0V	O	GND
4	—	—	not connected
5	DI 1	I	Digital input DI 1
6	DC 24V	O	DC 24V for sensor
7	0V	O	GND
8	—	—	not connected

I: Input, O: Output

**In-/Output area**

With configured ETS functionality (ETS=edge time stamp) and the corresponding edge the current time value of the System SLIO  $\mu$ s timer is stored together with the state of the inputs and a running number as ETS entry in the process image.

You may configure the following variants:

- 021-1BB70 DI 2xDC24V (20): uses 20byte in the PII for 5 ETS entries
- 021-1BB70 DI 2xDC24V (60): uses 60byte in the PII for 15 ETS entries

**Output area**

No byte of the output area is used by the module.

**Input area 20byte respectively 60byte**

Depending on the configured variant, the module serves for an area for 5 resp. 15 ETS entries. Each ETS entry uses 4byte in input area:

**Input area**

The input range is used for status message. At CPU, PROFIBUS and PROFINET the input respectively output area is embedded to the corresponding address area.

IX - IX = Index for access via CANopen. With s = Subindex the corresponding ETS entry is addressed.

SX - Subindex for access via EtherCAT with Index 6000h + EtherCAT-Slot

More can be found in the according manual of your bus coupler.

**Structure of an ETS entry**

Addr.	Name	Bytes	Function	IX	SX
+0	PII	1	State of the inputs	5430h/s	01h
+1	RN	1	Running number		02h
+2	ETS_US	2	µs ticker		03h

**PII** Here the state of the inputs after an edge change is stored.  
 The input byte has the following bit assignment:  
 Bit 0: DI 0  
 Bit 1: DI 1  
 Bit 2 ... 7: 0 (fix)

**RN** The **R**unning **N**umber (RN) is a continuous number 0 ... 127, which starts with 1. The RN corresponds to the chronological order of the edges.

**ETS\_US** In the System SLIO module there is a 32 bit timer (µs ticker). With PowerON the timer starts counting with 0. After  $2^{32}-1\mu\text{s}$  the timer starts with 0 again.  
 ETS\_US always contains the low word of the µs ticker (0...65535µs).

**ETS functionality** With the corresponding edge the value of the timer is stored as ETS entry in the process image as ETS\_US together with the state of the inputs PII and the running number RN.  
 The following figure shows the sequence of how the ETS entries are stored in the input area.

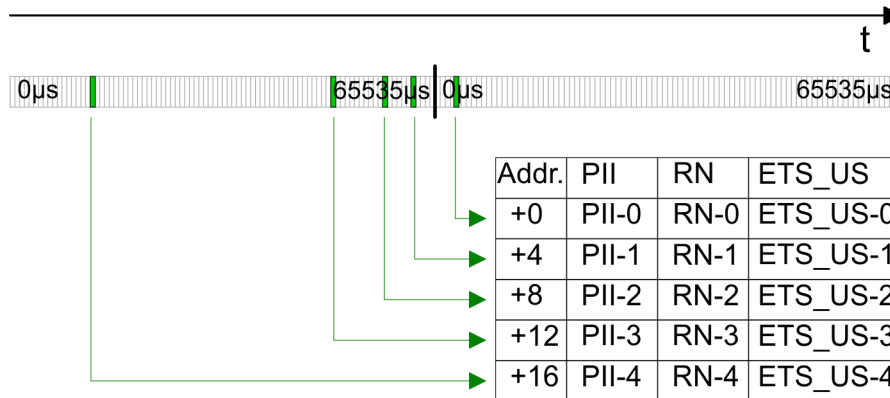

**Input area** The input range is used for status message. At CPU, PROFIBUS and PROFINET the input respectively output area is embedded to the corresponding address area.  
 IX - IX = Index for access via CANopen. With s = Subindex the corresponding ETS entry is addressed.  
 SX - Subindex for access via EtherCAT with Index 6000h + EtherCAT-Slot  
 More can be found in the according manual of your bus coupler.

**Configured as 021-1BB70** DI 2xDC 24V (20) 20byte - 5 ETS entries

021-1BB70 - DI 2xDC 24V ETS

Addr.	PII	IX=5430h	SX	Addr.	RN	IX=5430h	SX	Addr.	ETS-US	IX=5430h	SX
+0	PII-0	s=1	01h	+1	RN-0	s=1	02h	+2	ETS_US-0	s=1	03h
+4	PII-1	s=2	04h	+5	RN-1	s=2	05h	+6	ETS_US-1	s=2	06h
+8	PII-2	s=3	07h	+9	RN-2	s=3	08h	+10	ETS_US-2	s=3	09h
+12	PII-3	s=4	0Ah	+13	RN-3	s=4	0Bh	+14	ETS_US-3	s=4	0Ch
+16	PII-4	s=5	0Dh	+17	RN-4	s=5	0Eh	+18	ETS_US-4	s=5	0Fh

Configured as 021-1BB70 DI 2xDC 24V (60) 60byte - 15 ETS entries

Addr.	PII	IX=5430h	SX	Addr.	RN	IX=5430h	SX	Addr.	ETS-US	IX=5430h	SX
+0	PII-0	s=1	01h	+1	RN-0	s=1	02h	+2	ETS_US-0	s=1	03h
+4	PII-1	s=2	04h	+5	RN-1	s=2	05h	+6	ETS_US-1	s=2	06h
+8	PII-2	s=3	07h	+9	RN-2	s=3	08h	+10	ETS_US-2	s=3	09h
+12	PII-3	s=4	0Ah	+13	RN-3	s=4	0Bh	+14	ETS_US-3	s=4	0Ch
+16	PII-4	s=5	0Dh	+17	RN-4	s=5	0Eh	+18	ETS_US-4	s=5	0Fh
+20	PII-5	s=6	10h	+21	RN-5	s=6	11h	+22	ETS_US-5	s=6	12h
+24	PII-6	s=7	13h	+25	RN-6	s=7	14h	+26	ETS_US-6	s=7	15h
+28	PII-7	s=8	16h	+29	RN-7	s=8	17h	+30	ETS_US-7	s=8	18h
+32	PII-8	s=9	19h	+33	RN-8	s=9	1Ah	+34	ETS_US-8	s=9	1Bh
+36	PII-9	s=10	1Ch	+37	RN-9	s=10	1Dh	+38	ETS_US-9	s=10	1Eh
+40	PII-10	s=11	1Fh	+41	RN-10	s=11	20h	+42	ETS_US-10	s=11	21h
+44	PII-11	s=12	22h	+45	RN-11	s=12	23h	+46	ETS_US-11	s=12	24h
+48	PII-12	s=13	25h	+49	RN-12	s=13	26h	+50	ETS_US-12	s=13	27h
+52	PII-13	s=14	28h	+53	RN-13	s=14	29h	+54	ETS_US-13	s=14	2Ah
+56	PII-14	s=15	2Bh	+57	RN-14	s=15	2Ch	+58	ETS_US-14	s=15	2Dh



*The ETS module may only be accessed by the System SLIO CPU by means of SFC 14 or via the process image.*



## 3.4.1 Technical data

Order no.	021-1BB70
Type	SM 021
Module ID	0F01 47C1
<b>Current consumption/power loss</b>	
Current consumption from backplane bus	100 mA
Power loss	0.9 W
<b>Technical data digital inputs</b>	
Number of inputs	2
Cable length, shielded	1000 m
Cable length, unshielded	600 m
Rated load voltage	DC 24 V
Current consumption from load voltage L+ (without load)	10 mA
Rated value	DC 20.4...28.8 V
Input voltage for signal "0"	DC 0...5 V
Input voltage for signal "1"	DC 15...28.8 V
Input voltage hysteresis	-
Signal logic input	Sinking input
Frequency range	-
Input resistance	-
Input current for signal "1"	3 mA
Connection of Two-Wire-BEROs possible	✓
Max. permissible BERO quiescent current	0.5 mA
Input delay of "0" to "1"	parameterizable 2µs - 3ms
Input delay of "1" to "0"	parameterizable 2µs - 3ms
Number of simultaneously utilizable inputs horizontal configuration	2
Number of simultaneously utilizable inputs vertical configuration	2
Input characteristic curve	IEC 61131-2, type 1
Initial data size	60 Byte
<b>Status information, alarms, diagnostics</b>	
Status display	green LED per channel
Interrupts	no
Process alarm	no
Diagnostic interrupt	no
Diagnostic functions	no
Diagnostics information read-out	possible

Order no.	021-1BB70
Module state	green LED
Module error display	red LED
Channel error display	none
<b>Isolation</b>	
Between channels	-
Between channels of groups to	-
Between channels and backplane bus	✓
Insulation tested with	DC 500 V
<b>Safety</b>	
Safety protocol	-
Safety requirements	-
Secure user address	-
Watchdog	-
Two channels	-
Test pulse outputs	-
<b>Datasizes</b>	
Input bytes	20 / 60
Output bytes	0
Parameter bytes	10
Diagnostic bytes	20
<b>Housing</b>	
Material	PPE / PPE GF10
Mounting	Profile rail 35 mm
<b>Mechanical data</b>	
Dimensions (WxHxD)	12.9 mm x 109 mm x 76.5 mm
Net weight	58 g
Weight including accessories	58 g
Gross weight	73 g
<b>Environmental conditions</b>	
Operating temperature	0 °C to 60 °C
Storage temperature	-25 °C to 70 °C
<b>Certifications</b>	
UL certification	yes
KC certification	yes

### 3.4.2 Parameter data

The following variants may be configured:

- 021-1BB70 DI 2xDC24V (20):  
uses 20byte in the PII for 5 ETS entries
- 021-1BB70 DI 2xDC24V (60):  
uses 60byte in the PII for 15 ETS entries

#### 3.4.2.1 Parameters

DS - Record set for access via CPU, PROFIBUS and PROFINET

IX - Index for access via CANopen

SX - Subindex for access via EtherCAT with Index 3100h + EtherCAT-Slot

More can be found in the according manual of your bus coupler.

Name	Bytes	Function	Default	DS	IX	SX
PII_L	1	Length process image input data <sup>1,2</sup>	14h resp. 3Ch (fix)	02h	3100h	01h
PIQ_L	1	Length process image output data <sup>2</sup>	00h (fix)	02h	3101h	02h
CH0D	1	Input delay DI 0	02h	01h	3102h	03h
CH1D	1	Input delay DI 1	02h	01h	3103h	04h
TSER	1	Raising edge 0-1 at DI x	00h	80h	3104h	05h
TSEF	1	Falling edge 1-0 at DI x	00h	80h	3105h	06h

1) This parameter corresponds of the configured variant.

2) This record set may only be transferred at STOP state.

PII_L	Byte	Bit 7 ... 0
	0	The length for the process image is fixed adjusted to the length of the parameterized variant (14h or 3Ch).

PIQ_L	Byte	Bit 7 ... 0
	0	The length of the process image of the output data is fix set to 0byte.

CHxD DI x	Byte	Description	Possible values
	0	Input delay DI x	00h: 2µs      07h: 86µs 02h: 4µs      09h: 342µs 04h: 12µs     0Ch: 2731µs
			Other values are not permissible!

With the help of filters you may e.g. filter signal peaks at a blurred input signal.

**Edge select**

Here the ETS function for DI 0 and DI 1 may be activated. With these 2 bytes you may define the type of edge of the input signal, to which the current  $\mu$ s timer value is stored in the process image together with the state of the inputs.

**TSER edge 0-1 DI x**

Byte	Bit 7 ... 0
0	Bit 0: ETS record at edge 0-1 (rising edge) DI 0 Bit 1: ETS record at edge 0-1 (rising edge) DI 1 (0: disable, 1: enable) Bit 7 ... 2: reserved

**TSEF edge 1-0 DI x**

Byte	Bit 7 ... 0
0	Bit 0: ETS record at edge 1-0 (falling edge) DI 0 Bit 1: ETS record at edge 1-0 (falling edge) DI 1 (0: disable, 1: enable) Bit 7 ... 2: reserved

**3.4.2.2 Example of the principle of operation**

In the following it is demonstrated by an example, in which order the ETS entries are stored.

In this example a module is configured, which occupies 20byte for 5 ETS entries.

The following edges for the input channels are preset.

- DI 0: Edge 0-1:  $\uparrow$
- DI 1: Edge 1-0:  $\downarrow$

The green area of the diagram indicates the ETS entries, which were available at time "t". ETS entries, which are not (longer) available are marked red.

**Process image is empty**

New ETS entries are always registered starting from address +0. Thereby already existing ETS entries are shifted 4 byte each.

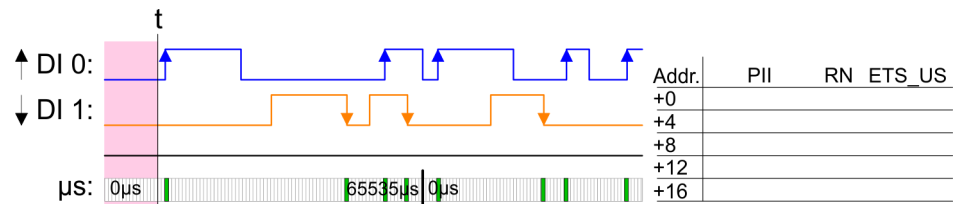

**1. ETS entry**

Released by an edge 0-1 from DI 0 the 1. ETS entry is registered starting from address +0.

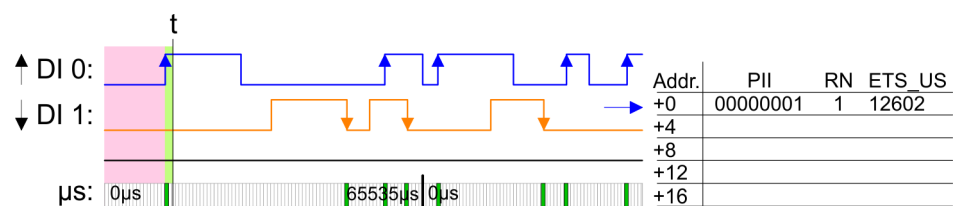

**2. ETS entry**

Released by an edge 1-0 from DI 1 the 2. ETS entry is registered starting from address +0 and the 1. ETS entry is shifted 4 byte.

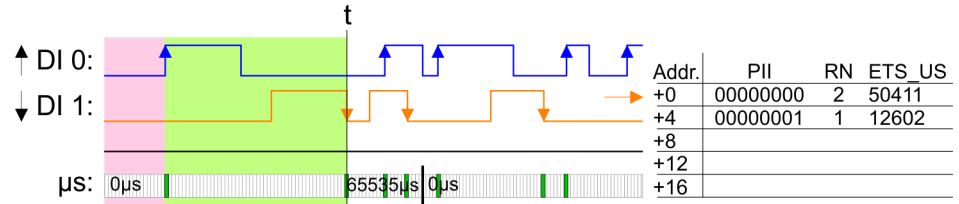

**3. ETS entry**

Released by an edge 1-0 from DI 1 the 2. ETS entry is registered starting from address +0 and the 1. ETS entry is shifted 4 byte.

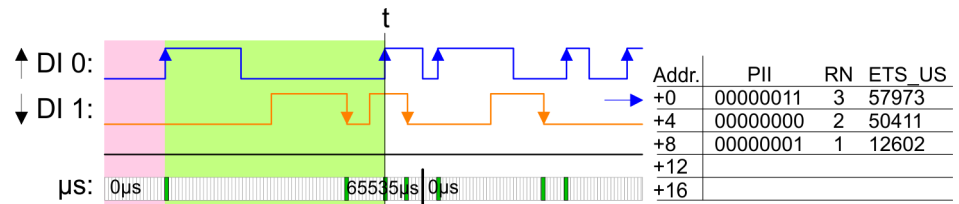

**4. ETS entry**

Released by an edge 1-0 from DI 1 the 4. ETS entry is registered starting from address +0 and already existing ETS entries are shifted 4 byte each.

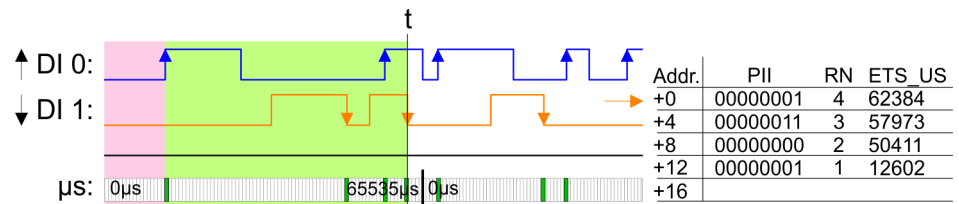

**5. ETS entry**

Released by an edge 0-1 from DI 0 the 5. ETS entry is registered starting from address +0 and already existing ETS entries are shifted 4 byte each. The maximum number of ETS entries is reached.

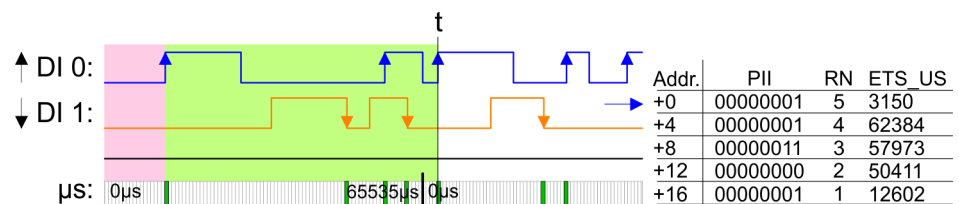

**6. ETS entry**

Released by an edge 1-0 from DI 1 the 6. ETS entry is registered starting from address +0 and already existing ETS entries are shifted 4 byte each. Thereby the 1. ETS entry is deleted and is not available any longer.

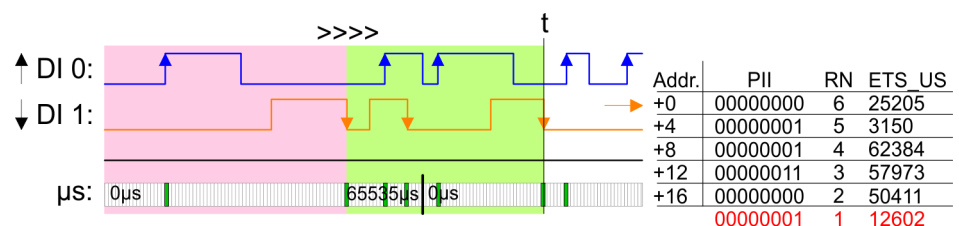

**7. ETS entry**

Released by an edge 0-1 from DI 0 the 7. ETS entry is registered starting from address +0 and already existing ETS entries are shifted 4 byte each. Thereby the 2. ETS entry is deleted and is not available any longer.

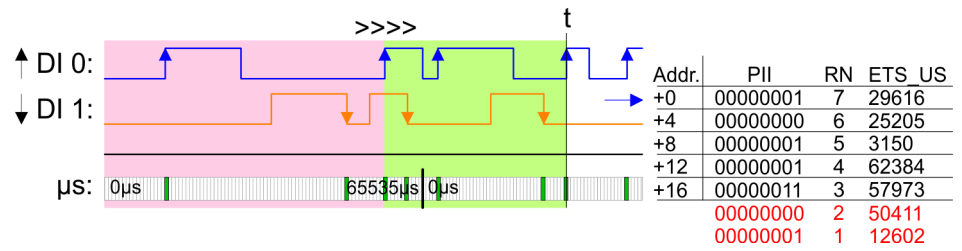

**8. ETS entry**

Released by an edge 0-1 from DI 0 the 8. ETS entry is registered starting from address +0 and already existing ETS entries are shifted 4 byte each. Thereby the 3. ETS entry is deleted and is not available any longer.

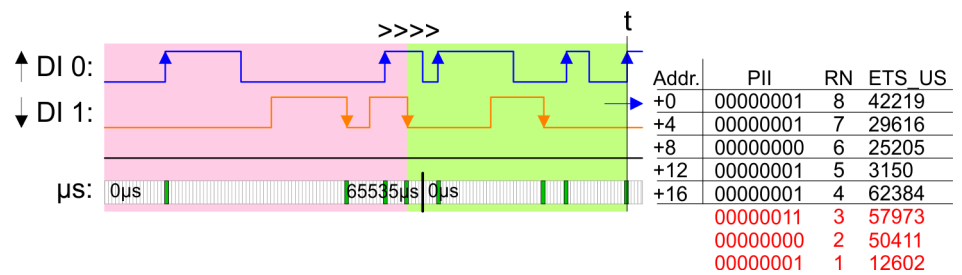

Please consider the ETS modules can only effectively be used together with head modules, which have an integrated  $\mu$ s ticker. The Ethernet coupler with ModbusTCP 053-1MT00 for example does not have an  $\mu$ s ticker.

**3.4.3 Diagnostic data**

So this module does not support interrupt functions, the diagnostic data serve the information about this module.

- DS - Record set for access via CPU, PROFIBUS and PROFINET. The access happens by DS 01h. Additionally the first 4 bytes may be accessed by DS 00h.
  - IX - Index for access via CANopen. The access happens by IX 2F01h. Additionally the first 4 bytes may be accessed by IX 2F00h.
  - SX - Subindex for access via EtherCAT with Index 5005h.
- More can be found in the according manual of your bus coupler.

Name	Bytes	Function	Default	DS	IX	SX
ERR_A	1	reserved	00h	01h	2F01h	02h
MODTYP	1	Module information	1Fh			03h
ERR_C	1	reserved	00h			04h
ERR_D	1	reserved	00h			05h
CHTYP	1	Channel type	70h			06h
NUMBIT	1	Number of diagnostics bits per channel	00h			07h
NUMCH	1	Number channels of the module	02h			08h
CHERR	1	reserved	00h			09h
CH0ERR... CH7ERR	8	reserved	00h			0Ah ... 11h
DIAG_US	4	µs ticker (32bit)	00h			13h

**MODTYP Module information**

Byte	Bit 7 ... 0
0	Bit 3 ... 0: Module class 1111b Digital module Bit 4: Channel information present Bit 7 ... 5: reserved

**CHTYP Channel type**

Byte	Bit 7 ... 0
0	Bit 6 ... 0: Channel type 70h: Digital input Bit 7: 0 (fix)

**NUMBIT Diagnostic bits**

Byte	Bit 7 ... 0
0	Number of diagnostics bits of the module per channel (here 00h)

**NUMCH channels**

Byte	Bit 7 ... 0
0	Number of channels of the module (here 02h)

**DIAG\_US µs ticker**

Byte	Bit 7 ... 0
0 ... 3	Value of the µs ticker at the moment of the diagnostic data generation

**ERR\_A/C/D CHERR,  
CHxERR reserved**

Byte	Bit 7 ... 0
0	reserved

### 3.5 021-1BD00 - DI 4xDC 24V

#### Properties

The electronic module collects the binary control signals from the process level and transmits them isolated to the central bus system. It has 4 channels and their status is monitored via LEDs.

- 4 digital inputs, isolated to the backplane bus
- Suited for switches and approximate switches
- Status indication of the channels via LEDs also with de-activated electronic power supply

#### Structure

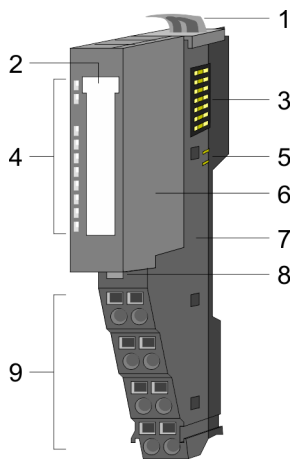

- 1 Locking lever terminal module
- 2 Labeling strip
- 3 Backplane bus
- 4 LED status indication
- 5 DC 24V power section supply
- 6 Electronic module
- 7 Terminal module
- 8 Locking lever electronic module
- 9 Terminal

#### Status indication

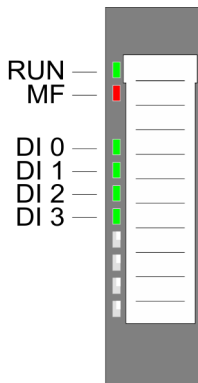

RUN	MF	DI x	Description
<input checked="" type="checkbox"/> green	<input checked="" type="checkbox"/> red	<input checked="" type="checkbox"/> green	
<input checked="" type="checkbox"/>	<input type="checkbox"/>	X	Bus communication is OK Module status is OK
<input checked="" type="checkbox"/>	<input checked="" type="checkbox"/>	X	Bus communication is OK Module status reports an error
<input type="checkbox"/>	<input checked="" type="checkbox"/>	X	Bus communication is not possible Module status reports an error
<input type="checkbox"/>	<input type="checkbox"/>	X	Error at bus power supply
X	<input checked="" type="checkbox"/> 2Hz	X	Flashing: Error in configuration <a href="#">Chap. 2.12 'Trouble shooting - LEDs' page 39</a>
<input checked="" type="checkbox"/>	<input type="checkbox"/>	<input checked="" type="checkbox"/>	Digital input has signal "1"
<input checked="" type="checkbox"/>	<input type="checkbox"/>	<input type="checkbox"/>	Digital input has signal "0"
not relevant: X			



**Pin assignment**

For wires with a cross section of 0.08mm<sup>2</sup> up to 1.5mm<sup>2</sup>.

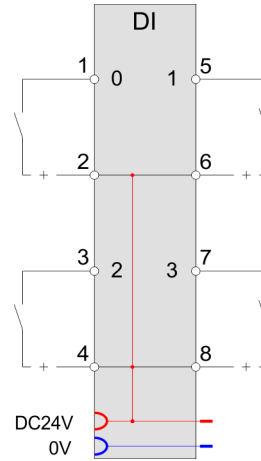
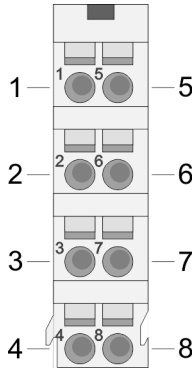

Pos.	Function	Type	Description
1	DI 0	I	Digital input DI 0
2	DC 24V	O	DC 24V for sensor
3	DI 2	I	Digital input DI 2
4	DC 24V	O	DC 24V for sensor
5	DI 1	I	Digital input DI 1
6	DC 24V	O	DC 24V for sensor
7	DI 3	I	Digital input DI 3
8	DC 24V	O	DC 24V for sensor

I: Input, O: Output

**Input area**

At CPU, PROFIBUS and PROFINET the input area is embedded to the corresponding address area.

IX - Index for access via CANopen

SX - Subindex for access via EtherCAT with Index 6000h + EtherCAT-Slot

More can be found in the according manual of your bus coupler.

Addr.	Name	Bytes	Function	IX	SX
+0	PII	1	State of the inputs	5000h	
			Bit 0: DI 0		01h
			Bit 1: DI 1		02h
			Bit 2: DI 2		03h
			Bit 3: DI 3		04h
			Bit 7 ... 4: reserved		

**Output area**

No byte of the output area is used by the module.

## 3.5.1 Technical data

Order no.	021-1BD00
Type	SM 021
Module ID	0003 9F84
<b>Current consumption/power loss</b>	
Current consumption from backplane bus	65 mA
Power loss	0.6 W
<b>Technical data digital inputs</b>	
Number of inputs	4
Cable length, shielded	1000 m
Cable length, unshielded	600 m
Rated load voltage	-
Current consumption from load voltage L+ (without load)	-
Rated value	DC 20.4...28.8 V
Input voltage for signal "0"	DC 0...5 V
Input voltage for signal "1"	DC 15...28.8 V
Input voltage hysteresis	-
Signal logic input	Sinking input
Frequency range	-
Input resistance	-
Input capacitance	-
Input current for signal "1"	3 mA
Connection of Two-Wire-BEROs possible	✓
Max. permissible BERO quiescent current	0.5 mA
Input delay of "0" to "1"	3 ms
Input delay of "1" to "0"	3 ms
Number of simultaneously utilizable inputs horizontal configuration	4
Number of simultaneously utilizable inputs vertical configuration	4
Input characteristic curve	IEC 61131-2, type 1
Initial data size	4 Bit
<b>Status information, alarms, diagnostics</b>	
Status display	green LED per channel
Interrupts	no
Process alarm	no
Diagnostic interrupt	no
Diagnostic functions	no

Order no.	021-1BD00
Diagnostics information read-out	none
Module state	green LED
Module error display	red LED
Channel error display	none
<b>Isolation</b>	
Between channels	-
Between channels of groups to	-
Between channels and backplane bus	✓
Insulation tested with	DC 500 V
<b>Safety</b>	
Safety protocol	-
Safety requirements	-
Secure user address	-
Watchdog	-
Two channels	-
Test pulse outputs	-
<b>Datasizes</b>	
Input bytes	1
Output bytes	0
Parameter bytes	0
Diagnostic bytes	0
<b>Housing</b>	
Material	PPE / PPE GF10
Mounting	Profile rail 35 mm
<b>Mechanical data</b>	
Dimensions (WxHxD)	12.9 mm x 109 mm x 76.5 mm
Net weight	57 g
Weight including accessories	57 g
Gross weight	72 g
<b>Environmental conditions</b>	
Operating temperature	0 °C to 60 °C
Storage temperature	-25 °C to 70 °C
<b>Certifications</b>	
UL certification	yes
KC certification	yes

### 3.6 021-1BD10 - DI 4xDC 24V 2µs...3ms

#### Properties

The electronic module collects the binary control signals from the process level and transmits them isolated to the central bus system. It has 4 fast digital input channels and their status is monitored via LEDs.

- 4 fast digital inputs, isolated to the backplane bus
- Suited for switches and approximate switches
- Status indication of the channels via LEDs also with de-activated electronic power supply
- Parameterizable input delay
- Interrupt and diagnostics function

#### Structure

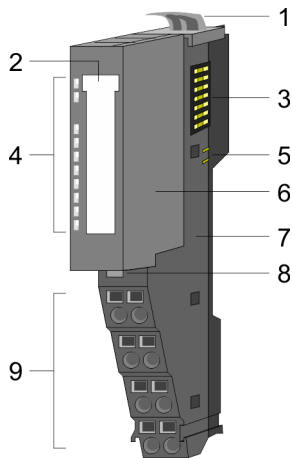

- 1 Locking lever terminal module
- 2 Labeling strip
- 3 Backplane bus
- 4 LED status indication
- 5 DC 24V power section supply
- 6 Electronic module
- 7 Terminal module
- 8 Locking lever electronic module
- 9 Terminal

#### Status indication

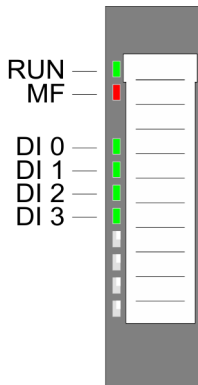

RUN	MF	DI x	Description
<input checked="" type="checkbox"/> green	<input checked="" type="checkbox"/> red	<input checked="" type="checkbox"/> green	
<input checked="" type="checkbox"/>	<input type="checkbox"/>	X	Bus communication is OK Module status is OK
<input checked="" type="checkbox"/>	<input checked="" type="checkbox"/>	X	Bus communication is OK Module status reports an error
<input type="checkbox"/>	<input checked="" type="checkbox"/>	X	Bus communication is not possible Module status reports an error
<input type="checkbox"/>	<input type="checkbox"/>	X	Error at bus power supply
X	<input checked="" type="checkbox"/> 2Hz	X	Flashing: Error in configuration <i>↳ Chap. 2.12 'Trouble shooting - LEDs' page 39</i>
<input checked="" type="checkbox"/>	<input type="checkbox"/>	<input checked="" type="checkbox"/>	Digital input has signal "1"
<input checked="" type="checkbox"/>	<input type="checkbox"/>	<input type="checkbox"/>	Digital input has signal "0"
not relevant: X			

**Pin assignment**

For wires with a cross section of 0.08mm<sup>2</sup> up to 1.5mm<sup>2</sup>.

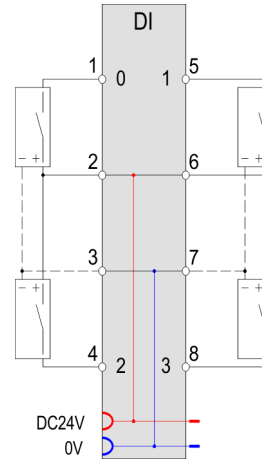
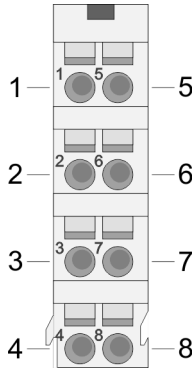

Pos.	Function	Type	Description
1	DI 0	I	Digital input DI 0
2	DC 24V	O	DC 24V for sensor
3	0V	O	GND
4	DI 2	I	Digital input DI 2
5	DI 1	I	Digital input DI 1
6	DC 24V	O	DC 24V for sensor
7	0V	O	GND
8	DI 3	O	Digital input DI 3

I: Input, O: Output

**Input area**

At CPU, PROFIBUS and PROFINET the input area is embedded to the corresponding address area.

IX - Index for access via CANopen

SX - Subindex for access via EtherCAT with Index 6000h + EtherCAT-Slot

More can be found in the according manual of your bus coupler.

Addr.	Name	Bytes	Function	IX	SX
+0	PII	1	State of the inputs	5000h	
			Bit 0: DI 0		01h
			Bit 1: DI 1		02h
			Bit 2: DI 2		03h
			Bit 3: DI 3		04h
			Bit 7 ... 4: reserved		

**Output area**

No byte of the output area is used by the module.

## 3.6.1 Technical data

Order no.	021-1BD10
Type	SM 021
Module ID	0009 1F04
<b>Current consumption/power loss</b>	
Current consumption from backplane bus	100 mA
Power loss	0.95 W
<b>Technical data digital inputs</b>	
Number of inputs	4
Cable length, shielded	1000 m
Cable length, unshielded	600 m
Rated load voltage	DC 20.4...28.8 V
Current consumption from load voltage L+ (without load)	15 mA
Rated value	DC 20.4...28.8 V
Input voltage for signal "0"	DC 0...5 V
Input voltage for signal "1"	DC 15...28.8 V
Input voltage hysteresis	-
Signal logic input	Sinking input
Frequency range	-
Input resistance	-
Input capacitance	-
Input current for signal "1"	3 mA
Connection of Two-Wire-BEROs possible	✓
Max. permissible BERO quiescent current	0.5 mA
Input delay of "0" to "1"	parameterizable 2µs - 3ms
Input delay of "1" to "0"	parameterizable 2µs - 3ms
Number of simultaneously utilizable inputs horizontal configuration	4
Number of simultaneously utilizable inputs vertical configuration	4
Input characteristic curve	IEC 61131-2, type 1
Initial data size	4 Bit
<b>Status information, alarms, diagnostics</b>	
Status display	green LED per channel
Interrupts	yes, parameterizable
Process alarm	yes, parameterizable
Diagnostic interrupt	yes, parameterizable
Diagnostic functions	yes

Order no.	021-1BD10
Diagnostics information read-out	possible
Module state	green LED
Module error display	red LED
Channel error display	none
<b>Isolation</b>	
Between channels	-
Between channels of groups to	-
Between channels and backplane bus	✓
Insulation tested with	DC 500 V
<b>Safety</b>	
Safety protocol	-
Safety requirements	-
Secure user address	-
Watchdog	-
Two channels	-
Test pulse outputs	-
<b>Datasizes</b>	
Input bytes	1
Output bytes	0
Parameter bytes	11
Diagnostic bytes	20
<b>Housing</b>	
Material	PPE / PPE GF10
Mounting	Profile rail 35 mm
<b>Mechanical data</b>	
Dimensions (WxHxD)	12.9 mm x 109 mm x 76.5 mm
Net weight	59 g
Weight including accessories	59 g
Gross weight	73 g
<b>Environmental conditions</b>	
Operating temperature	0 °C to 60 °C
Storage temperature	-25 °C to 70 °C
<b>Certifications</b>	
UL certification	yes
KC certification	yes

### 3.6.2 Parameter data

DS - Record set for access via CPU, PROFIBUS and PROFINET

IX - Index for access via CANopen

SX - Subindex for access via EtherCAT with Index 3100h + EtherCAT-Slot

More can be found in the according manual of your bus coupler.

Name	Bytes	Function	Default	DS	IX	SX
DIAG_EN	1	Diagnostic interrupt <sup>1)</sup>	00h	00h	3100h	01h
CH0D	1	Input delay DI 0	02h	01h	3101h	02h
CH1D	1	Input delay DI 1	02h	01h	3102h	03h
CH2D	1	Input delay DI 2	02h	01h	3103h	04h
CH3D	1	Input delay DI 3	02h	01h	3104h	05h
INTRE	1	Diagnostic interrupt at edge 0-1 of DI x	00h	80h	3105h	06h
INTFE	1	Diagnostic interrupt at edge 1-0 of DI x	00h	80h	3106h	07h

1) This record set may only be transferred at STOP state.

#### DIAG\_EN Diagnostic interrupt

Byte	Bit 7 ... 0
0	Diagnostic interrupt 00h: disable 40h: enable

- Here you activate res. de-activate the diagnostic function.

#### CHxD Input delay

Byte	Function	Possible values
0	Input delay DI x	00h: 2µs      07h: 86µs 02h: 4µs      09h: 342µs 04h: 12µs     0Ch: 2731µs
Other values are not permissible!		

- *Input delay* allows you to preset a filter for the corresponding channel. With the help of filters you may e.g. filter signal peaks at a blurred input signal.

#### INTRE Interrupt edge 0-1

Byte	Bit 7 ... 0
0	Bit 0: Diagnostic interrupt at edge 0-1 of DI 0 Bit 1: Diagnostic interrupt at edge 0-1 of DI 1 Bit 2: Diagnostic interrupt at edge 0-1 of DI 2 Bit 3: Diagnostic interrupt at edge 0-1 of DI 3 (0: disable, 1: enable) Bit 7 ... 4: reserved



**INTFE Interrupt edge 1-0**

Byte	Bit 7 ... 0
0	Bit 0: Diagnostic interrupt at edge 1-0 of DI 0 Bit 1: Diagnostic interrupt at edge 1-0 of DI 1 Bit 2: Diagnostic interrupt at edge 1-0 of DI 2 Bit 3: Diagnostic interrupt at edge 1-0 of DI 3 (0: disable, 1: enable) Bit 7 ... 4: reserved

**3.6.3 Diagnostics and interrupt**

Event	Process interrupt	Diagnostics interrupt	parameterizable
Edge 0-1 DI x	X	-	X
Edge 1-0 DI x	X	-	X
Diagnostics buffer overflow	-	X	-
Process interrupt lost	-	X	-

**Hardware interrupt**

So you may react to asynchronous events, there is the possibility to activate a hardware interrupt.

- A hardware interrupt interrupts the linear program sequence and jumps depending on the master system to a corresponding Interrupt routine. Here you can react to the hardware interrupt accordingly.
- With CANopen the hardware interrupt data is transferred via an emergency telegram.
- Operating with CPU, PROFIBUS and PROFINET the hardware interrupt data were transferred via diagnostics telegram.

SX - Subindex for access via EtherCAT with Index 5000h

More can be found in the according manual of your bus coupler.

Name	Bytes	Function	Default	SX
PRIT_A	1	Process interrupt data	00h	02h
PRIT_B	1	State of the inputs	00h	03h
PRIT_US	2	µs ticker	00h	04h (high byte) 05h (low byte)

**PRIT\_A Process interrupt data**

Byte	Bit 7 ... 0
0	Bit 0: Edge at Digital input DI 0 Bit 1: Edge at Digital input DI 1 Bit 2: Edge at Digital input DI 2 Bit 3: Edge at Digital input DI 3 Bit 7 ... 4: reserved

**PRIT\_B State of the inputs**

Byte	Bit 7 ... 0
0	State of the inputs at the moment of the process interrupt Bit 0: State Input DI 0 Bit 1: State Input DI 1 Bit 2: State Input DI 2 Bit 3: State Input DI 3 Bit 7 ... 4: reserved

**PRIT\_US µs ticker**

Byte	Bit 7 ... 0
0 ... 1	Value of the µs ticker at the moment of the process interrupt

*µs ticker*

In the System SLIO module there is a 32 bit timer (µs ticker). With PowerON the timer starts counting with 0. After  $2^{32}-1\mu\text{s}$  the timer starts with 0 again.

PRIT\_US represents the lower 2 byte of the µs ticker value (0 ...  $2^{16}-1$ ).

**Diagnostic data**

Via the parameterization you may activate a diagnostic interrupt for the module.

With a diagnostics interrupt the module serves for diagnostics data for diagnostic interrupt<sub>incoming</sub>.

As soon as the reason for releasing a diagnostic interrupt is no longer present, the diagnostic interrupt<sub>going</sub> automatically takes place.

All events of a channel between diagnostic interrupt<sub>incoming</sub> and diagnostic interrupt<sub>going</sub> are not stored and get lost.

Within this time window (1. diagnostic interrupt<sub>incoming</sub> until last diagnostic interrupt<sub>going</sub>) the MF-LED of the module is on.

DS - Record set for access via CPU, PROFIBUS and PROFINET. The access happens by DS 01h. Additionally the first 4 bytes may be accessed by DS 00h.

IX - Index for access via CANopen. The access happens by IX 2F01h. Additionally the first 4 bytes may be accessed by IX 2F00h.

SX - Subindex for access via EtherCAT with Index 5005h.

More can be found in the according manual of your bus coupler.

Name	Bytes	Function	Default	DS	IX	SX
ERR_A	1	Diagnostic	00h	01h	2F01h	02h
MODTYP	1	Module information	1Fh			03h
ERR_C	1	reserved	00h			04h
ERR_D	1	Diagnostic	00h			05h
CHTYP	1	Channel type	70h			06h
NUMBIT	1	Number of diagnostics bits per channel	00h			07h
NUMCH	1	Number channels of the module	04h			08h
CHERR	1	Channel error	00h			09h
CH0ERR... CH7ERR	8	reserved	00h			0Ah ... 11h
DIAG_US	4	µs ticker	00h			13h

**ERR\_A Diagnostic**

Byte	Bit 7 ... 0
0	Bit 0: set at module failure Bit 1: reserved Bit 2: set at external error Bit 3: set at channel error Bit 7 ... 4: reserved

**MODTYP Module information**

Byte	Bit 7 ... 0
0	Bit 3 ... 0: Module class 1111b: Digital module Bit 4: Channel information present Bit 7 ... 5: reserved

**ERR\_C reserved**

Byte	Bit 7 ... 0
0	reserved

**ERR\_D Diagnostic**

Byte	Bit 7 ... 0
0	Bit 2 ... 0: reserved Bit 3: set at internal diagnostics buffer overflow Bit 5 ... 4: reserved Bit 6: Process interrupt lost Bit 7: reserved

**CHTYP Channel type**

Byte	Bit 7 ... 0
0	Bit 6 ... 0: Channel type 70h: Digital input Bit 7: reserved

**NUMBIT Diagnostic bits**

Byte	Bit 7 ... 0
0	Number of diagnostics bits of the module per channel (here 00h)

**NUMCH Channels**

Byte	Bit 7 ... 0
0	Number of channels of the module (here 04h)

**CHERR Channel error**

Byte	Bit 7 ... 0
0	Bit 0: Edge lost at DI 0 Bit 1: Edge lost at DI 1 Bit 2: Edge lost at DI 2 Bit 3: Edge lost at DI 3 Bit 7 ... 4: reserved

**CHxERR reserved**

Byte	Bit 7 ... 0
0	reserved

**DIAG\_US µs ticker**

Byte	Bit 7 ... 0
0 ... 3	Value of the µs ticker at the moment of the diagnostic

*µs ticker*

In the System SLIO module there is a 32 bit timer (µs ticker). With PowerON the timer starts counting with 0. After  $2^{32}-1\mu\text{s}$  the timer starts with 0 again.

### 3.7 021-1BD40 - DI 4xDC 24V 3 wire

#### Properties

The electronic module collects the binary control signals from the process level and transmits them isolated to the central bus system. It has 4 channels and their status is monitored via LEDs.

- 4 digital inputs with 3 wire connection, isolated to the backplane bus
- Suited for switches and approximate switches
- Status indication of the channels via LEDs also with de-activated electronic power supply

#### Structure

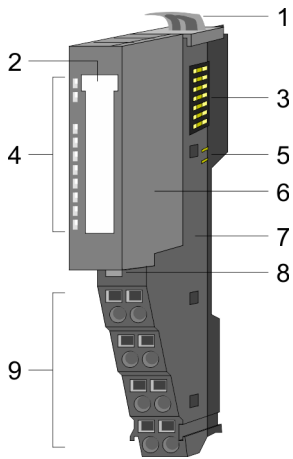

- 1 Locking lever terminal module
- 2 Labeling strip
- 3 Backplane bus
- 4 LED status indication
- 5 DC 24V power section supply
- 6 Electronic module
- 7 Terminal module
- 8 Locking lever electronic module
- 9 Terminal

#### Status indication

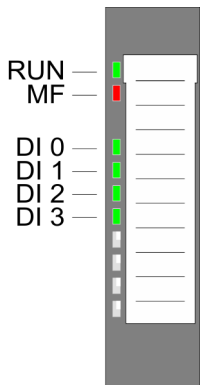

RUN	MF	DI x	Description
<input checked="" type="checkbox"/> green	<input checked="" type="checkbox"/> red	<input checked="" type="checkbox"/> green	
<input checked="" type="checkbox"/>	<input type="checkbox"/>	X	Bus communication is OK Module status is OK
<input checked="" type="checkbox"/>	<input checked="" type="checkbox"/>	X	Bus communication is OK Module status reports an error
<input type="checkbox"/>	<input checked="" type="checkbox"/>	X	Bus communication is not possible Module status reports an error
<input type="checkbox"/>	<input type="checkbox"/>	X	Error at bus power supply
X	<input checked="" type="checkbox"/> 2Hz	X	Flashing: Error in configuration <i>Chap. 2.12 'Trouble shooting - LEDs' page 39</i>
<input checked="" type="checkbox"/>	<input type="checkbox"/>	<input checked="" type="checkbox"/>	Digital input has signal "1"
<input checked="" type="checkbox"/>	<input type="checkbox"/>	<input type="checkbox"/>	Digital input has signal "0"
not relevant: X			

**Pin assignment**

For wires with a cross section of 0.08mm<sup>2</sup> up to 1.5mm<sup>2</sup>.

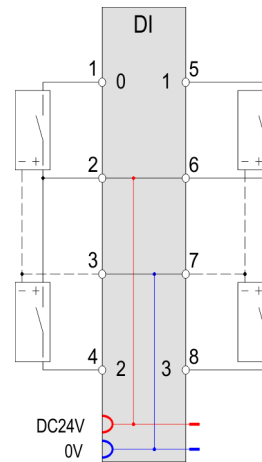
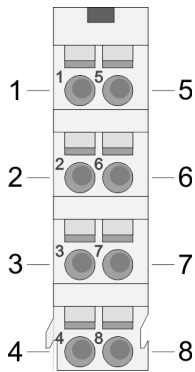

Pos.	Function	Type	Description
1	DI 0	I	Digital input DI 0
2	DC 24V	O	DC 24V for sensor
3	0V	O	GND
4	DI 2	I	Digital input DI 2
5	DI 1	I	Digital input DI 1
6	DC 24V	O	DC 24V for sensor
7	0V	O	GND
8	DI 3	I	Digital input DI 3

I: Input, O: Output

**Input area**

At CPU, PROFIBUS and PROFINET the input area is embedded to the corresponding address area.

IX - Index for access via CANopen

SX - Subindex for access via EtherCAT with Index 6000h + EtherCAT-Slot

More can be found in the according manual of your bus coupler.

Addr.	Name	Bytes	Function	IX	SX
+0	PII	1	State of the inputs	5000h	
			Bit 0: DI 0		01h
			Bit 1: DI 1		02h
			Bit 2: DI 2		03h
			Bit 3: DI 3		04h
			Bit 7 ... 4: reserved		

**Output area**

No byte of the output area is used by the module.

## 3.7.1 Technical data

Order no.	021-1BD40
Type	SM 021
Module ID	0008 9F84
<b>Current consumption/power loss</b>	
Current consumption from backplane bus	65 mA
Power loss	0.6 W
<b>Technical data digital inputs</b>	
Number of inputs	4
Cable length, shielded	1000 m
Cable length, unshielded	600 m
Rated load voltage	-
Current consumption from load voltage L+ (without load)	-
Rated value	DC 20.4...28.8 V
Input voltage for signal "0"	DC 0...5 V
Input voltage for signal "1"	DC 15...28.8 V
Input voltage hysteresis	-
Signal logic input	Sinking input
Frequency range	-
Input resistance	-
Input capacitance	-
Input current for signal "1"	3 mA
Connection of Two-Wire-BEROs possible	✓
Max. permissible BERO quiescent current	0.5 mA
Input delay of "0" to "1"	3 ms
Input delay of "1" to "0"	3 ms
Number of simultaneously utilizable inputs horizontal configuration	4
Number of simultaneously utilizable inputs vertical configuration	4
Input characteristic curve	IEC 61131-2, type 1
Initial data size	4 Bit
<b>Status information, alarms, diagnostics</b>	
Status display	green LED per channel
Interrupts	no
Process alarm	no
Diagnostic interrupt	no
Diagnostic functions	no

<b>Order no.</b>	<b>021-1BD40</b>
Diagnostics information read-out	none
Module state	green LED
Module error display	red LED
Channel error display	none
<b>Isolation</b>	
Between channels	-
Between channels of groups to	-
Between channels and backplane bus	✓
Insulation tested with	DC 500 V
<b>Safety</b>	
Safety protocol	-
Safety requirements	-
Secure user address	-
Watchdog	-
Two channels	-
Test pulse outputs	-
<b>Datasizes</b>	
Input bytes	1
Output bytes	0
Parameter bytes	0
Diagnostic bytes	0
<b>Housing</b>	
Material	PPE / PPE GF10
Mounting	Profile rail 35 mm
<b>Mechanical data</b>	
Dimensions (WxHxD)	12.9 mm x 109 mm x 76.5 mm
Net weight	57 g
Weight including accessories	57 g
Gross weight	71 g
<b>Environmental conditions</b>	
Operating temperature	0 °C to 60 °C
Storage temperature	-25 °C to 70 °C
<b>Certifications</b>	
UL certification	yes
KC certification	yes



### 3.8 021-1BD50 - DI 4xDC 24V NPN

#### Properties

The electronic module collects the binary control signals from the process level and transmits them isolated to the central bus system. It has 4 channels and their status is monitored via LEDs. An input becomes active as soon as it is connected to ground.

- 4 digital inputs (Sourcing input), isolated to the backplane bus
- Suited for switches and approximate switches
- Status indication of the channels via LEDs also with de-activated electronic power supply

#### Structure

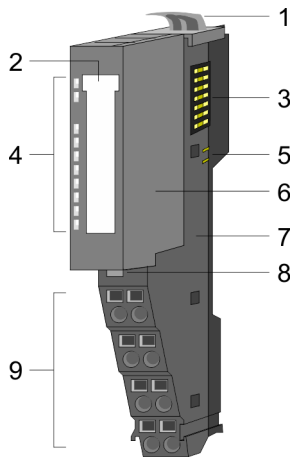

- 1 Locking lever terminal module
- 2 Labeling strip
- 3 Backplane bus
- 4 LED status indication
- 5 DC 24V power section supply
- 6 Electronic module
- 7 Terminal module
- 8 Locking lever electronic module
- 9 Terminal

#### Status indication

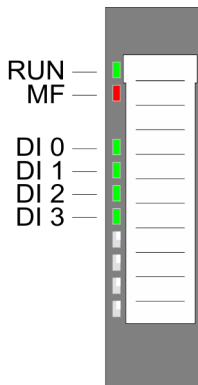

RUN	MF	DI x	Description
<input checked="" type="checkbox"/> green	<input checked="" type="checkbox"/> red	<input checked="" type="checkbox"/> green	
<input checked="" type="checkbox"/>	<input type="checkbox"/>	X	Bus communication is OK Module status is OK
<input checked="" type="checkbox"/>	<input checked="" type="checkbox"/>	X	Bus communication is OK Module status reports an error
<input type="checkbox"/>	<input checked="" type="checkbox"/>	X	Bus communication is not possible Module status reports an error
<input type="checkbox"/>	<input type="checkbox"/>	X	Error at bus power supply
X	<input checked="" type="checkbox"/> 2Hz	X	Flashing: Error in configuration <i>Chap. 2.12 'Trouble shooting - LEDs' page 39</i>
<input checked="" type="checkbox"/>	<input type="checkbox"/>	<input checked="" type="checkbox"/>	Digital input has signal "1"
<input checked="" type="checkbox"/>	<input type="checkbox"/>	<input type="checkbox"/>	Digital input has signal "0"
not relevant: X			

**Pin assignment**

For wires with a cross section of 0.08mm<sup>2</sup> up to 1.5mm<sup>2</sup>.

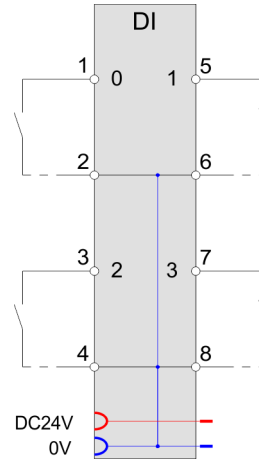
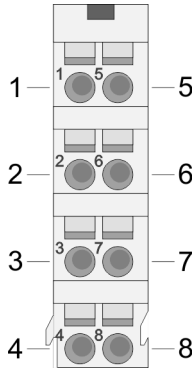

Pos.	Function	Type	Description
1	DI 0	I	Digital input DI 0
2	0V	O	GND
3	DI 2	I	Digital input DI 2
4	0V	O	GND
5	DI 1	I	Digital input DI 1
6	0V	O	GND
7	DI 3	I	Digital input DI 3
8	0V	O	GND

I: Input, O: Output

**Input area**

At CPU, PROFIBUS and PROFINET the input area is embedded to the corresponding address area.

IX - Index for access via CANopen

SX - Subindex for access via EtherCAT with Index 6000h + EtherCAT-Slot

More can be found in the according manual of your bus coupler.

Addr.	Name	Bytes	Function	IX	SX
+0	PII	1	State of the inputs	5000h	
			Bit 0: DI 0		01h
			Bit 1: DI 1		02h
			Bit 2: DI 2		03h
			Bit 3: DI 3		04h
			Bit 7 ... 4: reserved		

**Output area**

No byte of the output area is used by the module.

## 3.8.1 Technical data

Order no.	021-1BD50
Type	SM 021
Module ID	0004 9F84
<b>Current consumption/power loss</b>	
Current consumption from backplane bus	65 mA
Power loss	0.6 W
<b>Technical data digital inputs</b>	
Number of inputs	4
Cable length, shielded	1000 m
Cable length, unshielded	600 m
Rated load voltage	-
Current consumption from load voltage L+ (without load)	-
Rated value	DC 20.4...28.8 V
Input voltage for signal "0"	DC 15...28.8 V
Input voltage for signal "1"	DC 0...5 V
Input voltage hysteresis	-
Signal logic input	Sourcing input
Frequency range	-
Input resistance	-
Input capacitance	-
Input current for signal "1"	3 mA
Connection of Two-Wire-BEROs possible	✓
Max. permissible BERO quiescent current	0.5 mA
Input delay of "0" to "1"	3 ms
Input delay of "1" to "0"	3 ms
Number of simultaneously utilizable inputs horizontal configuration	4
Number of simultaneously utilizable inputs vertical configuration	4
Input characteristic curve	-
Initial data size	4 Bit
<b>Status information, alarms, diagnostics</b>	
Status display	green LED per channel
Interrupts	no
Process alarm	no
Diagnostic interrupt	no
Diagnostic functions	no

Order no.	021-1BD50
Diagnostics information read-out	none
Module state	green LED
Module error display	red LED
Channel error display	none
<b>Isolation</b>	
Between channels	-
Between channels of groups to	-
Between channels and backplane bus	✓
Insulation tested with	DC 500 V
<b>Safety</b>	
Safety protocol	-
Safety requirements	-
Secure user address	-
Watchdog	-
Two channels	-
Test pulse outputs	-
<b>Datasizes</b>	
Input bytes	1
Output bytes	0
Parameter bytes	0
Diagnostic bytes	0
<b>Housing</b>	
Material	PPE / PPE GF10
Mounting	Profile rail 35 mm
<b>Mechanical data</b>	
Dimensions (WxHxD)	12.9 mm x 109 mm x 76.5 mm
Net weight	58 g
Weight including accessories	58 g
Gross weight	72 g
<b>Environmental conditions</b>	
Operating temperature	0 °C to 60 °C
Storage temperature	-25 °C to 70 °C
<b>Certifications</b>	
UL certification	yes
KC certification	yes

### 3.9 021-1BD70 - DI 4xDC 24V ETS

#### Properties

The electronic module collects the binary control signals from the process level and transmits them isolated to the central bus system. It has 4 channels and their status is monitored via LEDs. With configured ETS functionality (ETS = edge time stamp) and the corresponding (rising/falling) edge the current time value of the System SLIO  $\mu$ s timer is stored together with the state of the inputs in the process image. Depending on the configuration 5 (20byte) respectively 15 (60byte) ETS entries may be stored in the process image one after another.

- 4 digital inputs, isolated to the backplane bus
- Configurable ETS functionality for 5 respectively 15 ETS entries (each 4byte)
- Diagnostics function
- Suited for switches and approximate switches
- Status indication of the channels via LEDs also with de-activated electronic power supply

#### Structure

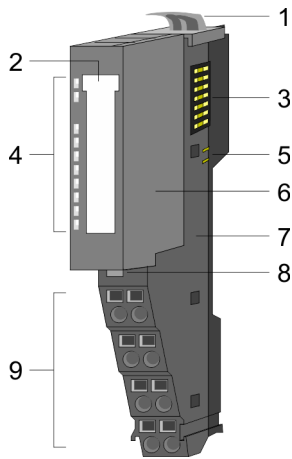

- 1 Locking lever terminal module
- 2 Labeling strip
- 3 Backplane bus
- 4 LED status indication
- 5 DC 24V power section supply
- 6 Electronic module
- 7 Terminal module
- 8 Locking lever electronic module
- 9 Terminal

#### Status indication

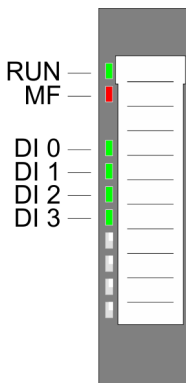

RUN	MF	DI x	Description
<input checked="" type="checkbox"/> green	<input checked="" type="checkbox"/> red	<input checked="" type="checkbox"/> green	
<input checked="" type="checkbox"/>	<input type="checkbox"/>	X	Bus communication is OK Module status is OK
<input checked="" type="checkbox"/>	<input checked="" type="checkbox"/>	X	Bus communication is OK Module status reports an error
<input type="checkbox"/>	<input checked="" type="checkbox"/>	X	Bus communication is not possible Module status reports an error
<input type="checkbox"/>	<input type="checkbox"/>	X	Error at bus power supply
X	<input checked="" type="checkbox"/> 2Hz	X	Flashing: Error in configuration <a href="#">Chap. 2.12 'Trouble shooting - LEDs'</a> page 39
<input checked="" type="checkbox"/>	<input type="checkbox"/>	<input checked="" type="checkbox"/>	Digital input has signal "1"
<input checked="" type="checkbox"/>	<input type="checkbox"/>	<input type="checkbox"/>	Digital input has signal "0"
not relevant: X			

**Pin assignment**

For wires with a cross section of 0.08mm<sup>2</sup> up to 1.5mm<sup>2</sup>.

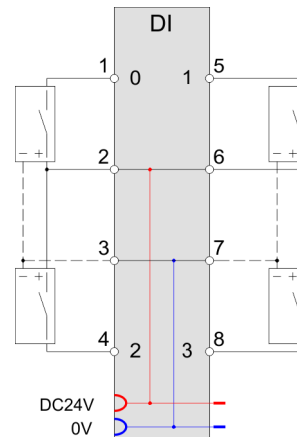
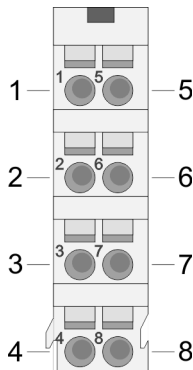

Pos.	Function	Type	Description
1	DI 0	I	Digital input DI 0
2	DC 24V	O	DC 24V for sensor
3	0V	O	GND
4	DI 2	I	Digital input DI 2
5	DI 1	I	Digital input DI 1
6	DC 24V	O	DC 24V for sensor
7	0V	O	GND
8	DI 3	I	Digital input DI 3

I: Input, O: Output

**In-/Output area**

With configured ETS functionality (ETS=edge time stamp) and the corresponding edge the current time value of the System SLIO  $\mu$ s timer is stored together with the state of the inputs and a running number as ETS entry in the process image.

You may configure the following variants:

- 021-1BD70 DI 4xDC24V (20): uses 20byte in the PII for 5 ETS entries
- 021-1BD70 DI 4xDC24V (60): uses 60byte in the PII for 15 ETS entries

**Output area**

No byte of the output area is used by the module.

**Input area 20byte respectively 60byte**

Depending on the configured variant, the module serves for an area for 5 resp. 15 ETS entries. Each ETS entry uses 4byte in input area:

**Input area**

The input range is used for status message. At CPU, PROFIBUS and PROFINET the input respectively output area is embedded to the corresponding address area.

IX - IX = Index for access via CANopen. With s = Subindex the corresponding ETS entry is addressed.

SX - Subindex for access via EtherCAT with Index 6000h + EtherCAT-Slot

More can be found in the according manual of your bus coupler.

**Structure of an ETS entry**

Addr.	Name	Bytes	Function	IX	SX
+0	PII	1	State of the inputs	5430h/s	01h
+1	RN	1	Running number		02h
+2	ETS_US	2	µs ticker		03h

**PII** Here the state of the inputs after an edge change is stored.

The input byte has the following bit assignment:

- Bit 0: DI 0
- Bit 1: DI 1
- Bit 2: DI 2
- Bit 3: DI 3
- Bit 4 ... 7: 0 (fix)

**RN** The **R**unning **N**umber (RN) is a continuous number 0 ... 127, which starts with 1. The RN corresponds to the chronological order of the edges.

**ETS\_US** In the System SLIO module there is a 32 bit timer (µs ticker). With PowerON the timer starts counting with 0. After  $2^{32}-1\mu\text{s}$  the timer starts with 0 again. ETS\_US always contains the low word of the µs ticker (0...65535µs).

**ETS functionality** With the corresponding edge the value of the timer is stored as ETS entry in the process image as ETS\_US together with the state of the inputs PII and the running number RN. The following figure shows the sequence of how the ETS entries are stored in the input area.

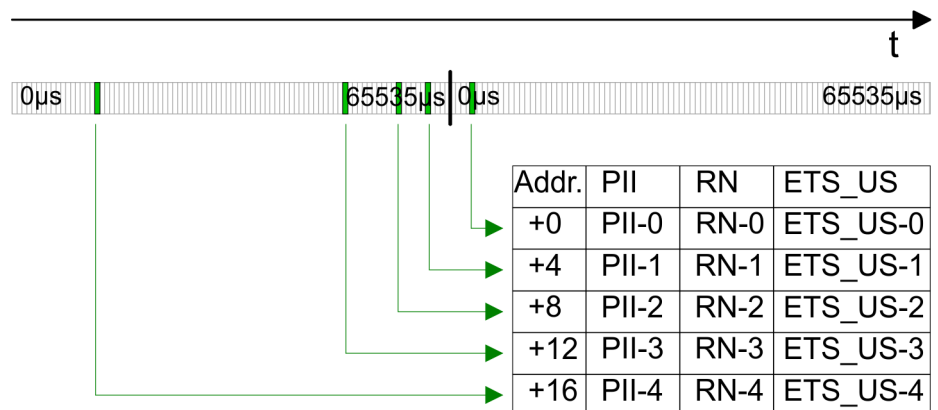

**Input area** The input range is used for status message. At CPU, PROFIBUS and PROFINET the input respectively output area is embedded to the corresponding address area.

IX - IX = Index for access via CANopen. With s = Subindex the corresponding ETS entry is addressed.

SX - Subindex for access via EtherCAT with Index 6000h + EtherCAT-Slot

More can be found in the according manual of your bus coupler.

021-1BD70 - DI 4xDC 24V ETS

**Configured as 021-1BD70** DI 4xDC 24V (20) 20byte - 5 ETS entries

Addr.	PII	IX=5430h	SX	Addr.	RN	IX=5430h	SX	Addr.	ETS-US	IX=5430h	SX
+0	PII-0	s=1	01h	+1	RN-0	s=1	02h	+2	ETS_US-0	s=1	03h
+4	PII-1	s=2	04h	+5	RN-1	s=2	05h	+6	ETS_US-1	s=2	06h
+8	PII-2	s=3	07h	+9	RN-2	s=3	08h	+10	ETS_US-2	s=3	09h
+12	PII-3	s=4	0Ah	+13	RN-3	s=4	0Bh	+14	ETS_US-3	s=4	0Ch
+16	PII-4	s=5	0Dh	+17	RN-4	s=5	0Eh	+18	ETS_US-4	s=5	0Fh

**Configured as 021-1BD70** DI 4xDC 24V (60) 60byte - 15 ETS entries

Addr.	PII	IX=5430h	SX	Addr.	RN	IX=5430h	SX	Addr.	ETS-US	IX=5430h	SX
+0	PII-0	s=1	01h	+1	RN-0	s=1	02h	+2	ETS_US-0	s=1	03h
+4	PII-1	s=2	04h	+5	RN-1	s=2	05h	+6	ETS_US-1	s=2	06h
+8	PII-2	s=3	07h	+9	RN-2	s=3	08h	+10	ETS_US-2	s=3	09h
+12	PII-3	s=4	0Ah	+13	RN-3	s=4	0Bh	+14	ETS_US-3	s=4	0Ch
+16	PII-4	s=5	0Dh	+17	RN-4	s=5	0Eh	+18	ETS_US-4	s=5	0Fh
+20	PII-5	s=6	10h	+21	RN-5	s=6	11h	+22	ETS_US-5	s=6	12h
+24	PII-6	s=7	13h	+25	RN-6	s=7	14h	+26	ETS_US-6	s=7	15h
+28	PII-7	s=8	16h	+29	RN-7	s=8	17h	+30	ETS_US-7	s=8	18h
+32	PII-8	s=9	19h	+33	RN-8	s=9	1Ah	+34	ETS_US-8	s=9	1Bh
+36	PII-9	s=10	1Ch	+37	RN-9	s=10	1Dh	+38	ETS_US-9	s=10	1Eh
+40	PII-10	s=11	1Fh	+41	RN-10	s=11	20h	+42	ETS_US-10	s=11	21h
+44	PII-11	s=12	22h	+45	RN-11	s=12	23h	+46	ETS_US-11	s=12	24h
+48	PII-12	s=13	25h	+49	RN-12	s=13	26h	+50	ETS_US-12	s=13	27h
+52	PII-13	s=14	28h	+53	RN-13	s=14	29h	+54	ETS_US-13	s=14	2Ah



*The ETS module may only be accessed by the System SLIO CPU by means of SFC 14 or via the process image.*



## 3.9.1 Technical data

Order no.	021-1BD70
Type	SM 021
Module ID	0F03 47C2
<b>Current consumption/power loss</b>	
Current consumption from backplane bus	100 mA
Power loss	0.95 W
<b>Technical data digital inputs</b>	
Number of inputs	4
Cable length, shielded	1000 m
Cable length, unshielded	600 m
Rated load voltage	DC 24 V
Current consumption from load voltage L+ (without load)	15 mA
Rated value	DC 20.4...28.8 V
Input voltage for signal "0"	DC 0...5 V
Input voltage for signal "1"	DC 15...28.8 V
Input voltage hysteresis	-
Signal logic input	Sinking input
Frequency range	-
Input resistance	-
Input capacitance	-
Input current for signal "1"	3 mA
Connection of Two-Wire-BEROs possible	✓
Max. permissible BERO quiescent current	0.5 mA
Input delay of "0" to "1"	parameterizable 2µs - 3ms
Input delay of "1" to "0"	parameterizable 2µs - 3ms
Number of simultaneously utilizable inputs horizontal configuration	4
Number of simultaneously utilizable inputs vertical configuration	4
Input characteristic curve	IEC 61131-2, type 1
Initial data size	60 Byte
<b>Status information, alarms, diagnostics</b>	
Status display	green LED per channel
Interrupts	no
Process alarm	no
Diagnostic interrupt	no
Diagnostic functions	no

Order no.	021-1BD70
Diagnostics information read-out	possible
Module state	green LED
Module error display	red LED
Channel error display	none
<b>Isolation</b>	
Between channels	-
Between channels of groups to	-
Between channels and backplane bus	✓
Insulation tested with	DC 500 V
<b>Safety</b>	
Safety protocol	-
Safety requirements	-
Secure user address	-
Watchdog	-
Two channels	-
Test pulse outputs	-
<b>Datasizes</b>	
Input bytes	20 / 60
Output bytes	0
Parameter bytes	12
Diagnostic bytes	20
<b>Housing</b>	
Material	PPE / PPE GF10
Mounting	Profile rail 35 mm
<b>Mechanical data</b>	
Dimensions (WxHxD)	12.9 mm x 109 mm x 76.5 mm
Net weight	58 g
Weight including accessories	58 g
Gross weight	73 g
<b>Environmental conditions</b>	
Operating temperature	0 °C to 60 °C
Storage temperature	-25 °C to 70 °C
<b>Certifications</b>	
UL certification	yes
KC certification	yes

### 3.9.2 Parameter data

The following variants may be configured:

- 021-1BD70 DI 4xDC24V (20):  
uses 20byte in the PII for 5 ETS entries
- 021-1BD70 DI 4xDC24V (60):  
uses 60byte in the PII for 15 ETS entries

#### 3.9.2.1 Parameters

DS - Record set for access via CPU, PROFIBUS and PROFINET

IX - Index for access via CANopen

SX - Subindex for access via EtherCAT with Index 3100h + EtherCAT-Slot

More can be found in the according manual of your bus coupler.

Name	Bytes	Function	Default	DS	IX	SX
PII_L	1	Length process image input data <sup>1, 2</sup>	14h resp. 3Ch (fix)	02h	3100h	01h
PIQ_L	1	Length process image output data <sup>2</sup>	00h (fix)	02h	3101h	02h
CH0D	1	Input delay DI 0	02h	01h	3102h	03h
CH1D	1	Input delay DI 1	02h	01h	3103h	04h
CH2D	1	Input delay DI 2	02h	01h	3104h	05h
CH3D	1	Input delay DI 3	02h	01h	3105h	06h
TSER	1	Raising edge 0-1 at DI x	00h	80h	3106h	07h
TSEF	1	Falling edge 1-0 at DI x	00h	80h	3107h	08h

1) This parameter corresponds of the configured variant.

2) This record set may only be transferred at STOP state.

PII_L	Byte	Bit 7 ... 0
	0	The length of the process image of the input data is fix set to the configured variant (14h or 3Ch).

PIQ_L	Byte	Bit 7 ... 0
	0	The length of the process image of the output data is fix set to 0 byte.

CHxD DI x	Byte	Description	Possible values	
	0	Input delay DI x	00h: 2µs	07h: 86µs
		02h: 4µs	09h: 342µs	
		04h: 12µs	0Ch: 2731µs	

With the help of filters you may e.g. filter signal peaks at a blurred input signal.

**Edge select**

Here the ETS function for DI 0 ... DI 3 may be activated. With these 2 bytes you may define the type of edge of the input signal, to which the current  $\mu$ s timer value is stored in the process image together with the state of the inputs.

**TSER edge 0-1 DI x**

Byte	Bit 7 ... 0
0	Bit 0: ETS record at edge 0-1 (rising edge) DI 0 Bit 1: ETS record at edge 0-1 (rising edge) DI 1 Bit 2: ETS record at edge 0-1 (rising edge) DI 2 Bit 3: ETS record at edge 0-1 (rising edge) DI 3 (0: disable, 1: enable) Bit 7 ... 4: reserved

**TSEF edge 1-0 DI x**

Byte	Bit 7 ... 0
0	Bit 0: ETS record at edge 1-0 (falling edge) DI 0 Bit 1: ETS record at edge 1-0 (falling edge) DI 1 Bit 2: ETS record at edge 1-0 (falling edge) DI 2 Bit 3: ETS record at edge 1-0 (falling edge) DI 3 (0: disable, 1: enable) Bit 7 ... 4: reserved

**3.9.2.2 Example of the principle of operation**

In the following it is demonstrated by an example, in which order the ETS entries are stored.

In this example a module is configured, which occupies 20byte for 5 ETS entries.

The following edges for the input channels are preset.

- DI 0: Edge 0-1:  $\uparrow$
- DI 1: Edge 1-0:  $\downarrow$
- DI 2 and DI 3 are 0 constant

**Process image is empty**

New ETS entries are always registered starting from address +0. Thereby already existing ETS entries are shifted 4 byte each.

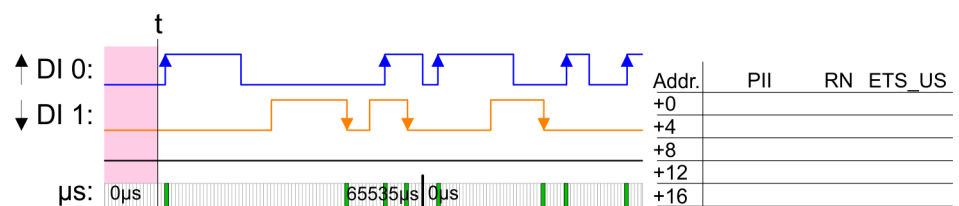

**1. ETS entry**

Released by an edge 0-1 from DI 0 the 1. ETS entry is registered starting from address +0.

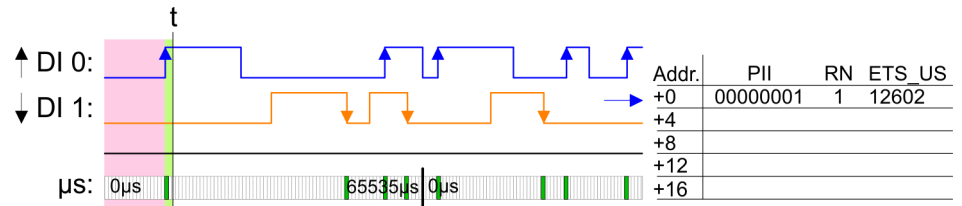

**2. ETS entry**

Released by an edge 1-0 from DI 1 the 2. ETS entry is registered starting from address +0 and the 1. ETS entry is shifted 4 byte.

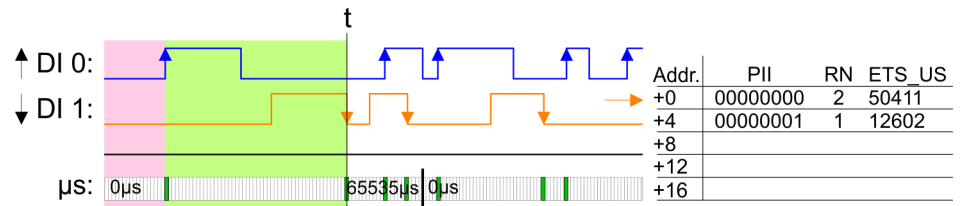

**3. ETS entry**

Released by an edge 0-1 from DI 0 the 3. ETS entry is registered starting from address +0 and already existing ETS entries are shifted 4 byte each.

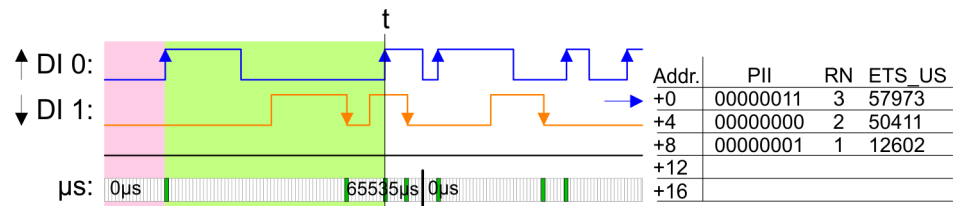

**4. ETS entry**

Released by an edge 1-0 from DI 1 the 4. ETS entry is registered starting from address +0 and already existing ETS entries are shifted 4 byte each.

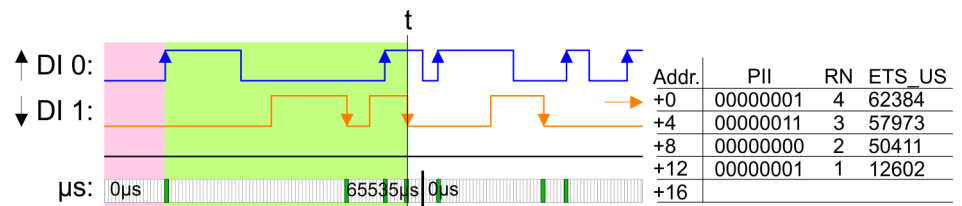

**5. ETS entry**

Released by an edge 0-1 from DI 0 the 5. ETS entry is registered starting from address +0 and already existing ETS entries are shifted 4 byte each. The maximum number of ETS entries is reached.

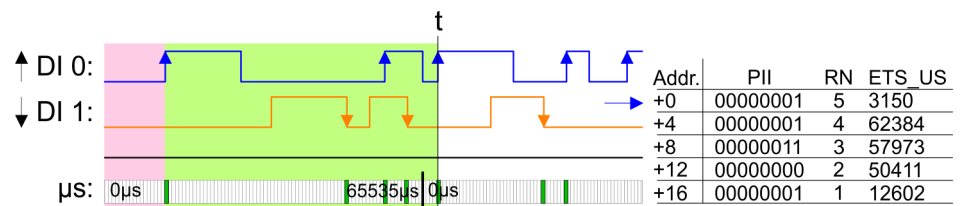

**6. ETS entry**

Released by an edge 1-0 from DI 1 the 6. ETS entry is registered starting from address +0 and already existing ETS entries are shifted 4 byte each. Thereby the 1. ETS entry is deleted and is not available any longer.

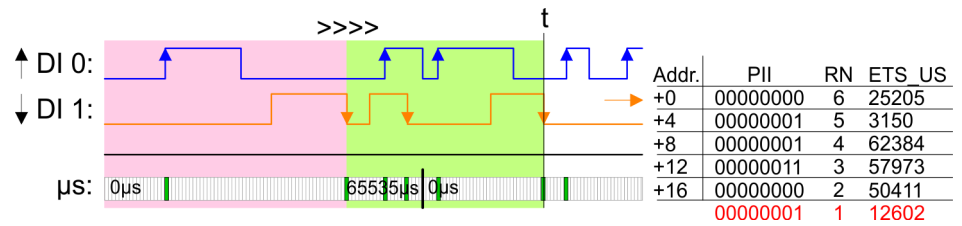

**7. ETS entry**

Released by an edge 0-1 from DI 0 the 7. ETS entry is registered starting from address +0 and already existing ETS entries are shifted 4 byte each. Thereby the 2. ETS entry is deleted and is not available any longer.

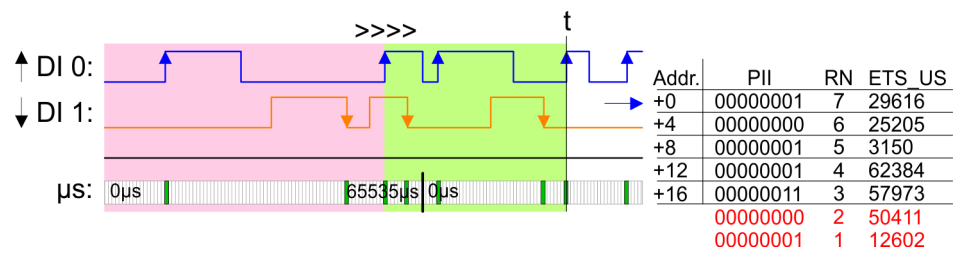

**8. ETS entry**

Released by an edge 0-1 from DI 0 the 8. ETS entry is registered starting from address +0 and already existing ETS entries are shifted 4 byte each. Thereby the 3. ETS entry is deleted and is not available any longer.

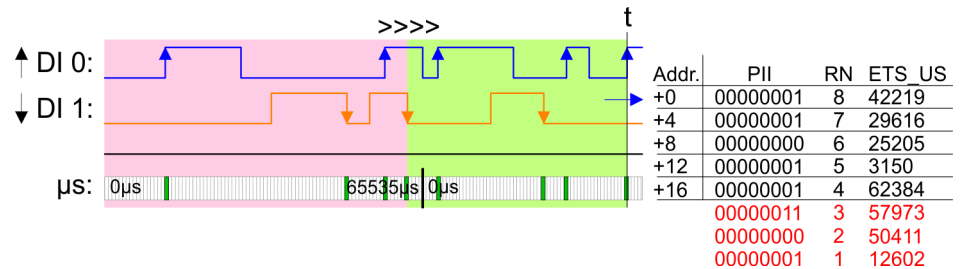

Please consider the ETS modules can only effectively be used together with head modules, which have an integrated µs ticker. The Ethernet coupler with ModbusTCP 053-1MT00 for example does not have an µs ticker.

**3.9.3 Diagnostic data**

So this module does not support interrupt functions, the diagnostic data serve the information about this module.

DS - Record set for access via CPU, PROFIBUS and PROFINET. The access happens by DS 01h. Additionally the first 4 bytes may be accessed by DS 00h.

IX - Index for access via CANopen. The access happens by IX 2F01h. Additionally the first 4 bytes may be accessed by IX 2F00h.

SX - Subindex for access via EtherCAT with Index 5005h.

More can be found in the according manual of your bus coupler.

Name	Bytes	Function	Default	DS	IX	SX
ERR_A	1	reserved	00h	01h	2F01h	02h
MODTYP	1	Module information	1Fh			03h
ERR_C	1	reserved	00h			04h
ERR_D	1	reserved	00h			05h
CHTYP	1	Channel type	70h			06h
NUMBIT	1	Number of diagnostics bits per channel	00h			07h
NUMCH	1	Number channels of the module	04h			08h
CHERR	1	reserved	00h			09h
CH0ERR... CH7ERR	8	reserved	00h			0Ah ... 11h
DIAG_US	4	µs ticker (32bit)	00h			13h

#### **MODTYP** Module information

Byte	Bit 7 ... 0
0	Bit 3 ... 0: Module class 1111b Digital module Bit 4: Channel information present Bit 7 ... 5: reserved

#### **CHTYP** Channel type

Byte	Bit 7 ... 0
0	Bit 6 ... 0: Channel type 70h: Digital input Bit 7: 0 (fix)

#### **NUMBIT** Diagnostic bits

Byte	Bit 7 ... 0
0	Number of diagnostics bits of the module per channel (here 00h)

---

021-1BD70 - DI 4xDC 24V ETS > Diagnostic data

**NUMCH channels**

Byte	Bit 7 ... 0
0	Number of channels of the module (here 04h)

**DIAG\_US  $\mu$ s ticker**

Byte	Bit 7 ... 0
0 ... 3	Value of the $\mu$ s ticker at the moment of the diagnostic data generation

**ERR\_A/C/D CHERR,  
CHxERR reserved**

Byte	Bit 7 ... 0
0	reserved



### 3.10 021-1BF00 - DI 8xDC 24V

#### Properties

The electronic module collects the binary control signals from the process level and transmits them isolated to the central bus system. It has 8 channels and their status is monitored via LEDs.

- 8 digital inputs, isolated to the backplane bus
- Suited for switches and approximate switches
- Status indication of the channels via LEDs also with de-activated electronic power supply

#### Structure

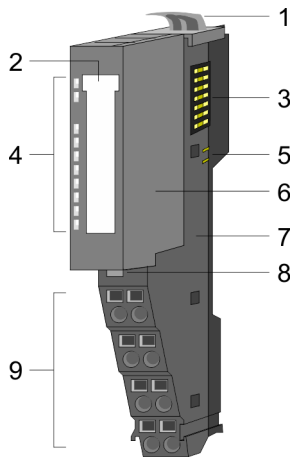

- 1 Locking lever terminal module
- 2 Labeling strip
- 3 Backplane bus
- 4 LED status indication
- 5 DC 24V power section supply
- 6 Electronic module
- 7 Terminal module
- 8 Locking lever electronic module
- 9 Terminal

#### Status indication

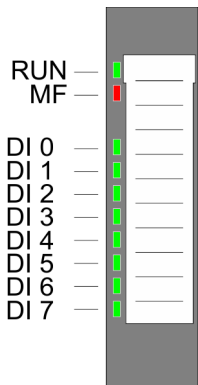

RUN	MF	DI x	Description
<input checked="" type="checkbox"/> green	<input checked="" type="checkbox"/> red	<input checked="" type="checkbox"/> green	
<input checked="" type="checkbox"/>	<input type="checkbox"/>	X	Bus communication is OK Module status is OK
<input checked="" type="checkbox"/>	<input checked="" type="checkbox"/>	X	Bus communication is OK Module status reports an error
<input type="checkbox"/>	<input checked="" type="checkbox"/>	X	Bus communication is not possible Module status reports an error
<input type="checkbox"/>	<input type="checkbox"/>	X	Error at bus power supply
X	<input checked="" type="checkbox"/> 2Hz	X	Flashing: Error in configuration <i>Chap. 2.12 'Trouble shooting - LEDs' page 39</i>
<input checked="" type="checkbox"/>	<input type="checkbox"/>	<input checked="" type="checkbox"/>	Digital input has signal "1"
<input checked="" type="checkbox"/>	<input type="checkbox"/>	<input type="checkbox"/>	Digital input has signal "0"
not relevant: X			

**Pin assignment**

For wires with a cross section of 0.08mm<sup>2</sup> up to 1.5mm<sup>2</sup>.

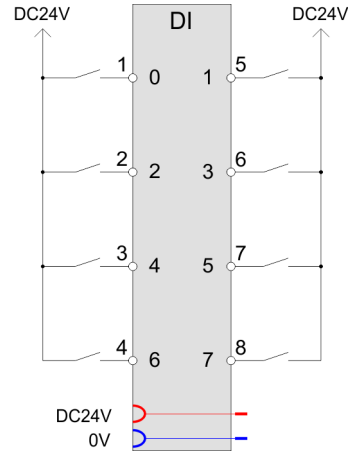
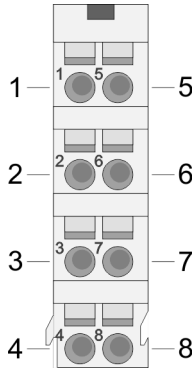

Pos.	Function	Type	Description
1	DI 0	I	Digital input DI 0
2	DI 2	I	Digital input DI 2
3	DI 4	I	Digital input DI 4
4	DI 6	I	Digital input DI 6
5	DI 1	I	Digital input DI 1
6	DI 3	I	Digital input DI 3
7	DI 5	I	Digital input DI 5
8	DI 7	I	Digital input DI 7

I: Input

**Input area**

At CPU, PROFIBUS and PROFINET the input area is embedded to the corresponding address area.

IX - Index for access via CANopen

SX - Subindex for access via EtherCAT with Index 6000h + EtherCAT-Slot

More can be found in the according manual of your bus coupler.

Addr.	Name	Bytes	Function	IX	SX
+0	PII	1	State of the inputs	6000h	
			Bit 0: DI 0		01h
			Bit 1: DI 1		02h
			Bit 2: DI 2		03h
			Bit 3: DI 3		04h
			Bit 4: DI 4		05h
			Bit 5: DI 5		06h
			Bit 6: DI 6		07h
			Bit 7: DI 7		08h

**Output area**

No byte of the output area is used by the module.

**3.10.1 Technical data**

<b>Order no.</b>	<b>021-1BF00</b>
Type	SM 021
Module ID	0005 9FC1
<b>Current consumption/power loss</b>	
Current consumption from backplane bus	65 mA
Power loss	0.9 W
<b>Technical data digital inputs</b>	
Number of inputs	8
Cable length, shielded	1000 m
Cable length, unshielded	600 m
Rated load voltage	-
Current consumption from load voltage L+ (without load)	-
Rated value	DC 20.4...28.8 V
Input voltage for signal "0"	DC 0...5 V
Input voltage for signal "1"	DC 15...28.8 V
Input voltage hysteresis	-
Signal logic input	Sinking input
Frequency range	-
Input resistance	-
Input capacitance	-
Input current for signal "1"	3 mA
Connection of Two-Wire-BEROs possible	✓

021-1BF00 - DI 8xDC 24V &gt; Technical data

Order no.	021-1BF00
Max. permissible BERO quiescent current	0.5 mA
Input delay of "0" to "1"	3 ms
Input delay of "1" to "0"	3 ms
Number of simultaneously utilizable inputs horizontal configuration	8
Number of simultaneously utilizable inputs vertical configuration	8
Input characteristic curve	IEC 61131-2, type 1
Initial data size	8 Bit
<b>Status information, alarms, diagnostics</b>	
Status display	green LED per channel
Interrupts	no
Process alarm	no
Diagnostic interrupt	no
Diagnostic functions	no
Diagnostics information read-out	none
Module state	green LED
Module error display	red LED
Channel error display	none
<b>Isolation</b>	
Between channels	-
Between channels of groups to	-
Between channels and backplane bus	✓
Insulation tested with	DC 500 V
<b>Safety</b>	
Safety protocol	-
Safety requirements	-
Secure user address	-
Watchdog	-
Two channels	-
Test pulse outputs	-
<b>Datasizes</b>	
Input bytes	1
Output bytes	0
Parameter bytes	0
Diagnostic bytes	0
<b>Housing</b>	

<b>Order no.</b>	<b>021-1BF00</b>
Material	PPE / PPE GF10
Mounting	Profile rail 35 mm
<b>Mechanical data</b>	
Dimensions (WxHxD)	12.9 mm x 109 mm x 76.5 mm
Net weight	57 g
Weight including accessories	57 g
Gross weight	71 g
<b>Environmental conditions</b>	
Operating temperature	0 °C to 60 °C
Storage temperature	-25 °C to 70 °C
<b>Certifications</b>	
UL certification	yes
KC certification	yes

### 3.11 021-1BF01 - DI 8xDC 24V 0.5ms

#### Properties

The electronic module collects the binary control signals from the process level and transmits them isolated to the central bus system. It has 8 channels and their status is monitored via LEDs.

- 8 digital inputs, isolated to the backplane bus
- Suited for switches and approximate switches
- Status indication of the channels via LEDs also with de-activated electronic power supply

#### Structure

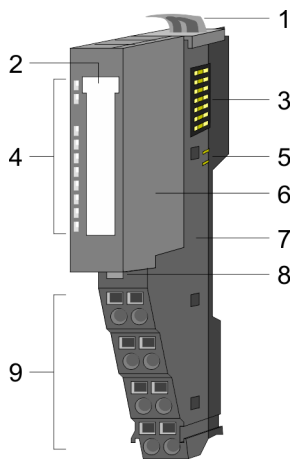

- 1 Locking lever terminal module
- 2 Labeling strip
- 3 Backplane bus
- 4 LED status indication
- 5 DC 24V power section supply
- 6 Electronic module
- 7 Terminal module
- 8 Locking lever electronic module
- 9 Terminal

#### Status indication

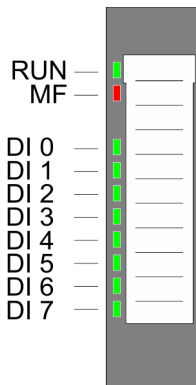

RUN	MF	DI x	Description
<input checked="" type="checkbox"/> green	<input checked="" type="checkbox"/> red	<input checked="" type="checkbox"/> green	
<input checked="" type="checkbox"/>	<input type="checkbox"/>	X	Bus communication is OK Module status is OK
<input checked="" type="checkbox"/>	<input checked="" type="checkbox"/>	X	Bus communication is OK Module status reports an error
<input type="checkbox"/>	<input checked="" type="checkbox"/>	X	Bus communication is not possible Module status reports an error
<input type="checkbox"/>	<input type="checkbox"/>	X	Error at bus power supply
X	<input checked="" type="checkbox"/> 2Hz	X	Flashing: Error in configuration <i>Chap. 2.12 'Trouble shooting - LEDs' page 39</i>
<input checked="" type="checkbox"/>	<input type="checkbox"/>	<input checked="" type="checkbox"/>	Digital input has signal "1"
<input checked="" type="checkbox"/>	<input type="checkbox"/>	<input type="checkbox"/>	Digital input has signal "0"
not relevant: X			

**Pin assignment**

For wires with a cross section of 0.08mm<sup>2</sup> up to 1.5mm<sup>2</sup>.

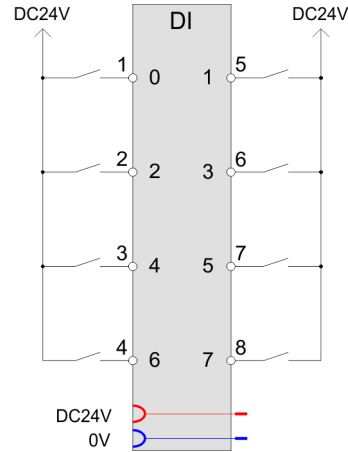
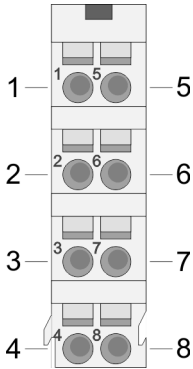

Pos.	Function	Type	Description
1	DI 0	I	Digital input DI 0
2	DI 2	I	Digital input DI 2
3	DI 4	I	Digital input DI 4
4	DI 6	I	Digital input DI 6
5	DI 1	I	Digital input DI 1
6	DI 3	I	Digital input DI 3
7	DI 5	I	Digital input DI 5
8	DI 7	I	Digital input DI 7

I: Input

**Input area**

At CPU, PROFIBUS and PROFINET the input area is embedded to the corresponding address area.

IX - Index for access via CANopen

SX - Subindex for access via EtherCAT with Index 6000h + EtherCAT-Slot

More can be found in the according manual of your bus coupler.

021-1BF01 - DI 8xDC 24V 0.5ms &gt; Technical data

Addr.	Name	Bytes	Function	IX	SX
+0	PII	1	State of the inputs	6000h	
			Bit 0: DI 0		01h
			Bit 1: DI 1		02h
			Bit 2: DI 2		03h
			Bit 3: DI 3		04h
			Bit 4: DI 4		05h
			Bit 5: DI 5		06h
			Bit 6: DI 6		07h
			Bit 7: DI 7		08h

**Output area**

No byte of the output area is used by the module.

**3.11.1 Technical data**

<b>Order no.</b>	<b>021-1BF01</b>
Type	SM 021
Module ID	0013 9FC1
<b>Current consumption/power loss</b>	
Current consumption from backplane bus	35 mA
Power loss	0.9 W
<b>Technical data digital inputs</b>	
Number of inputs	8
Cable length, shielded	1000 m
Cable length, unshielded	600 m
Rated load voltage	-
Current consumption from load voltage L+ (without load)	-
Rated value	DC 20.4...28.8 V
Input voltage for signal "0"	DC 0...5 V
Input voltage for signal "1"	DC 15...28.8 V
Input voltage hysteresis	-
Signal logic input	Sinking input
Frequency range	-
Input resistance	-
Input capacitance	-
Input current for signal "1"	3 mA
Connection of Two-Wire-BEROs possible	✓



Order no.	021-1BF01
Max. permissible BERO quiescent current	0.5 mA
Input delay of "0" to "1"	max. 500 µs
Input delay of "1" to "0"	max. 500 µs
Number of simultaneously utilizable inputs horizontal configuration	8
Number of simultaneously utilizable inputs vertical configuration	8
Input characteristic curve	IEC 61131-2, type 1
Initial data size	8 Bit
<b>Status information, alarms, diagnostics</b>	
Status display	green LED per channel
Interrupts	no
Process alarm	no
Diagnostic interrupt	no
Diagnostic functions	no
Diagnostics information read-out	none
Module state	green LED
Module error display	red LED
Channel error display	none
<b>Isolation</b>	
Between channels	-
Between channels of groups to	-
Between channels and backplane bus	✓
Insulation tested with	DC 500 V
<b>Safety</b>	
Safety protocol	-
Safety requirements	-
Secure user address	-
Watchdog	-
Two channels	-
Test pulse outputs	-
<b>Datasizes</b>	
Input bytes	1
Output bytes	0
Parameter bytes	0
Diagnostic bytes	0
<b>Housing</b>	

021-1BF01 - DI 8xDC 24V 0.5ms &gt; Technical data

<b>Order no.</b>	<b>021-1BF01</b>
Material	PPE / PPE GF10
Mounting	Profile rail 35 mm
<b>Mechanical data</b>	
Dimensions (WxHxD)	12.9 mm x 109 mm x 76.5 mm
Net weight	57 g
Weight including accessories	57 g
Gross weight	71 g
<b>Environmental conditions</b>	
Operating temperature	0 °C to 60 °C
Storage temperature	-25 °C to 70 °C
<b>Certifications</b>	
UL certification	yes
KC certification	yes

### 3.12 021-1BF50 - DI 8xDC 24V NPN

#### Properties

The electronic module collects the binary control signals from the process level and transmits them isolated to the central bus system. It has 8 channels and their status is monitored via LEDs. An input becomes active as soon as it is connected to ground.

- 8 digital inputs (Sourcing input), isolated to the backplane bus
- Suited for switches and approximate switches
- Status indication of the channels via LEDs also with de-activated electronic power supply

#### Structure

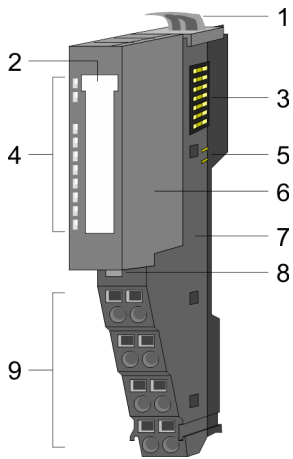

- 1 Locking lever terminal module
- 2 Labeling strip
- 3 Backplane bus
- 4 LED status indication
- 5 DC 24V power section supply
- 6 Electronic module
- 7 Terminal module
- 8 Locking lever electronic module
- 9 Terminal

#### Status indication

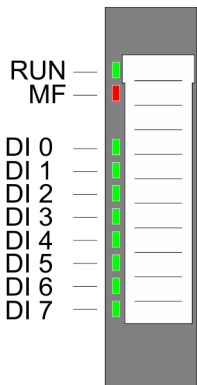

RUN	MF	DI x	Description
<input checked="" type="checkbox"/> green	<input checked="" type="checkbox"/> red	<input checked="" type="checkbox"/> green	
<input checked="" type="checkbox"/>	<input type="checkbox"/>	X	Bus communication is OK Module status is OK
<input checked="" type="checkbox"/>	<input checked="" type="checkbox"/>	X	Bus communication is OK Module status reports an error
<input type="checkbox"/>	<input checked="" type="checkbox"/>	X	Bus communication is not possible Module status reports an error
<input type="checkbox"/>	<input type="checkbox"/>	X	Error at bus power supply
X	<input checked="" type="checkbox"/> 2Hz	X	Flashing: Error in configuration <i>Chap. 2.12 'Trouble shooting - LEDs' page 39</i>
<input checked="" type="checkbox"/>	<input type="checkbox"/>	<input checked="" type="checkbox"/>	Digital input has signal "1"
<input checked="" type="checkbox"/>	<input type="checkbox"/>	<input type="checkbox"/>	Digital input has signal "0"
not relevant: X			

**Pin assignment**

For wires with a cross section of 0.08mm<sup>2</sup> up to 1.5mm<sup>2</sup>.

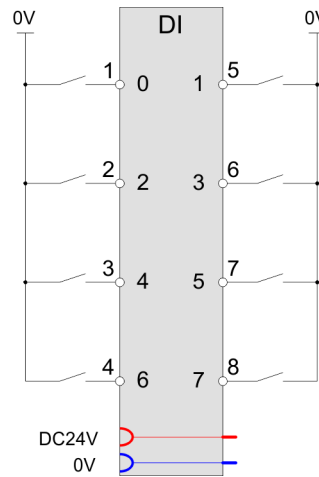
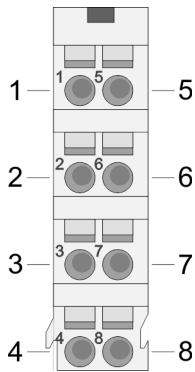

Pos.	Function	Type	Description
1	DI 0	I	Digital input DI 0
2	DI 2	I	Digital input DI 2
3	DI 4	I	Digital input DI 4
4	DI 6	I	Digital input DI 6
5	DI 1	I	Digital input DI 1
6	DI 3	I	Digital input DI 3
7	DI 5	I	Digital input DI 5
8	DI 7	I	Digital input DI 7

I: Input

**Input area**

At CPU, PROFIBUS and PROFINET the input area is embedded to the corresponding address area.

IX - Index for access via CANopen

SX - Subindex for access via EtherCAT with Index 6000h + EtherCAT-Slot

More can be found in the according manual of your bus coupler.

Addr.	Name	Bytes	Function	IX	SX
+0	PII	1	State of the inputs	6000h	
			Bit 0: DI 0		01h
			Bit 1: DI 1		02h
			Bit 2: DI 2		03h
			Bit 3: Di 3		04h
			Bit 4: DI 4		05h
			Bit 5: DI 5		06h
			Bit 6: DI 6		07h
			Bit 7: DI 7		08h

**Output area**

No byte of the output area is used by the module.

**3.12.1 Technical data**

<b>Order no.</b>	<b>021-1BF50</b>
Type	SM 021
Module ID	0007 9FC1
<b>Current consumption/power loss</b>	
Current consumption from backplane bus	65 mA
Power loss	0.9 W
<b>Technical data digital inputs</b>	
Number of inputs	8
Cable length, shielded	1000 m
Cable length, unshielded	600 m
Rated load voltage	-
Current consumption from load voltage L+ (without load)	-
Rated value	DC 20.4...28.8 V
Input voltage for signal "0"	DC 15...28.8 V
Input voltage for signal "1"	DC 0...5 V
Input voltage hysteresis	-
Signal logic input	Sourcing input
Frequency range	-
Input resistance	-
Input capacitance	-
Input current for signal "1"	3 mA
Connection of Two-Wire-BEROs possible	✓

021-1BF50 - DI 8xDC 24V NPN &gt; Technical data

Order no.	021-1BF50
Max. permissible BERO quiescent current	0.5 mA
Input delay of "0" to "1"	3 ms
Input delay of "1" to "0"	3 ms
Number of simultaneously utilizable inputs horizontal configuration	8
Number of simultaneously utilizable inputs vertical configuration	8
Input characteristic curve	-
Initial data size	8 Bit
<b>Status information, alarms, diagnostics</b>	
Status display	green LED per channel
Interrupts	no
Process alarm	no
Diagnostic interrupt	no
Diagnostic functions	no
Diagnostics information read-out	none
Module state	green LED
Module error display	red LED
Channel error display	none
<b>Isolation</b>	
Between channels	-
Between channels of groups to	-
Between channels and backplane bus	✓
Insulation tested with	DC 500 V
<b>Safety</b>	
Safety protocol	-
Safety requirements	-
Secure user address	-
Watchdog	-
Two channels	-
Test pulse outputs	-
<b>Datasizes</b>	
Input bytes	1
Output bytes	0
Parameter bytes	0
Diagnostic bytes	0
<b>Housing</b>	

<b>Order no.</b>	<b>021-1BF50</b>
Material	PPE / PPE GF10
Mounting	Profile rail 35 mm
<b>Mechanical data</b>	
Dimensions (WxHxD)	12.9 mm x 109 mm x 76.5 mm
Net weight	57 g
Weight including accessories	57 g
Gross weight	71 g
<b>Environmental conditions</b>	
Operating temperature	0 °C to 60 °C
Storage temperature	-25 °C to 70 °C
<b>Certifications</b>	
UL certification	yes
KC certification	yes

### 3.13 021-1BH00 - DI 16xDC 24V

#### Properties

The module detects the binary control signals from the process level and transmits them isolated to the higher-level bus system. It has 16 channels and their status is indicated by LEDs.

- 16 digital Inputs isolated to the backplane bus
- Suitable for switches and proximity switches
- Status indication of the channels via LEDs also with de-activated electronic power supply
- Parameterizable input delay

#### Structure

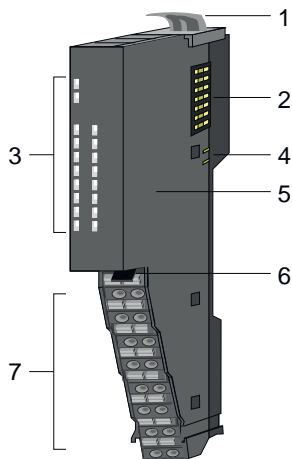

- 1 Locking lever module
- 2 Backplane bus
- 3 LED status indication
- 4 DC 24V power section supply
- 5 Electronic unit
- 6 Locking lever terminal block
- 7 Terminal block

#### Status indication

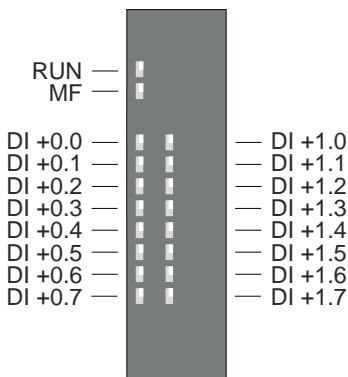

RUN	MF	DI x	Description
green	red	green	
■	□	X	Bus communication is OK Module status is OK
■	■	X	Bus communication is OK Module status reports an error
□	■	X	Bus communication is not possible Module status reports an error
□	□	X	Error at bus power supply
X	▣ 2Hz	X	Blinking: Error in configuration <i>Chap. 2.12 'Trouble shooting - LEDs' page 39</i>
■	□	■	Digital input has signal "1"
■	□	□	Digital input has signal "0"
not relevant: X			



**Pin assignment**

For wires with a core cross-section of 0.14mm<sup>2</sup> up to 0.75mm<sup>2</sup>. With a core cross-section < 0.25mm<sup>2</sup>, ferrules must be used. ↗ *'Data' page 26*

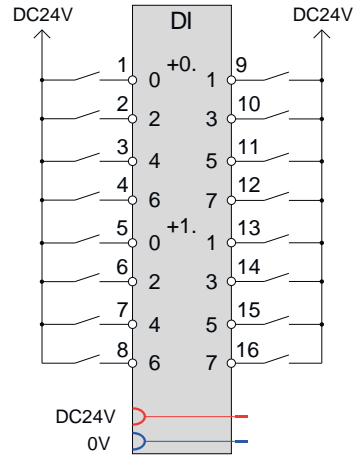
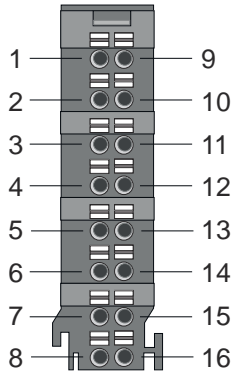

Pos.	Function	Type	Description
1	DI +0.0	I	Digital input DI +0.0
2	DI +0.2	I	Digital input DI +0.2
3	DI +0.4	I	Digital input DI +0.4
4	DI +0.6	I	Digital input DI +0.6
5	DI +1.0	I	Digital input DI +1.0
6	DI +1.2	I	Digital input DI +1.2
7	DI +1.4	I	Digital input DI +1.4
8	DI +1.6	I	Digital input DI +1.6
9	DI +0.1	I	Digital input DI +0.1
10	DI +0.3	I	Digital input DI +0.3
11	DI +0.5	I	Digital input DI +0.5
12	DI +0.7	I	Digital input DI +0.7
13	DI +1.1	I	Digital input DI +1.1
14	DI +1.3	I	Digital input DI +1.3
15	DI +1.5	I	Digital input DI +1.5
16	DI +1.7	I	Digital input DI +1.7

I: Input

**Input area**

At CPU, PROFIBUS and PROFINET the input area is embedded to the corresponding address area.

IX - Index for access via CANopen

SX - Subindex for access via EtherCAT with Index 6000h + EtherCAT-Slot

More can be found in the according manual of your bus coupler.

Addr.	Name	Byte	Function	IX	SX <sup>1</sup>
+0	PII	0	Status of the inputs	6000h	
			Bit 0: DI +0.0		01h
			Bit 1: DI +0.1		02h
			Bit 2: DI +0.2		03h
			Bit 3: DI +0.3		04h
			Bit 4: DI +0.4		05h
			Bit 5: DI +0.5		06h
			Bit 6: DI +0.6		07h
		Bit 7: DI +0.7	08h		
		1	Status of the inputs	6001h	
			Bit 0: DI +1.0		09h
			Bit 1: DI +1.1		0Ah
			Bit 2: DI +1.2		0Bh
			Bit 3: DI +1.3		0Ch
			Bit 4: DI +1.4		0Dh
			Bit 5: DI +1.5		0Eh
Bit 6: DI +1.6	0Fh				
Bit 7: DI +1.7	10h				

1) Can be displayed as 16 channels with the names DI 0 to DI 15.

**Output area**

No byte of the output area is used by the module.

**3.13.1 Technical data**

<b>Order no.</b>	<b>021-1BH00</b>
Type	SM 021
Module ID	0020 1FC2
<b>Current consumption/power loss</b>	
Current consumption from backplane bus	35 mA
Power loss	1.2 W
<b>Technical data digital inputs</b>	
Number of inputs	8
Cable length, shielded	1000 m
Cable length, unshielded	600 m
Rated load voltage	-
Current consumption from load voltage L+ (without load)	-

Order no.	021-1BH00
Rated value	DC 20.4...28.8 V
Input voltage for signal "0"	DC 0...5 V
Input voltage for signal "1"	DC 15...28.8 V
Input voltage hysteresis	-
Signal logic input	Sinking input
Frequency range	-
Input resistance	-
Input capacitance	-
Input current for signal "1"	2.3 mA
Connection of Two-Wire-BEROs possible	✓
Max. permissible BERO quiescent current	0.5 mA
Input delay of "0" to "1"	parameterizable 400µs - 23ms
Input delay of "1" to "0"	parameterizable 400µs - 23ms
Number of simultaneously utilizable inputs horizontal configuration	16
Number of simultaneously utilizable inputs vertical configuration	16
Input characteristic curve	IEC 61131-2, type 1
Initial data size	16 Bit
<b>Status information, alarms, diagnostics</b>	
Status display	green LED per channel
Interrupts	no
Process alarm	no
Diagnostic interrupt	no
Diagnostic functions	no
Diagnostics information read-out	none
Module state	green LED
Module error display	red LED
Channel error display	none
<b>Isolation</b>	
Between channels	-
Between channels of groups to	-
Between channels and backplane bus	✓
Insulation tested with	DC 500 V
<b>Safety</b>	
Safety protocol	-
Safety requirements	-

<b>Order no.</b>	<b>021-1BH00</b>
Secure user address	-
Watchdog	-
Two channels	-
Test pulse outputs	-
<b>Datasizes</b>	
Input bytes	2
Output bytes	0
Parameter bytes	1
Diagnostic bytes	0
<b>Housing</b>	
Material	PPE / PPE GF10
Mounting	Profile rail 35 mm
<b>Mechanical data</b>	
Dimensions (WxHxD)	12.9 mm x 109 mm x 76.5 mm
Net weight	52 g
Weight including accessories	52 g
Gross weight	66 g
<b>Environmental conditions</b>	
Operating temperature	0 °C to 60 °C
Storage temperature	-25 °C to 70 °C
<b>Certifications</b>	
UL certification	yes
KC certification	in preparation

### 3.13.2 Parameter data

DS - Record set for access via CPU, PROFIBUS and PROFINET

IX - Index for access via CANopen

SX - Subindex for access via EtherCAT with Index 3100h + EtherCAT-Slot

More can be found in the according manual of your bus coupler.

Name	Byte	Function	Default	DS	IX	SX
CHD	1	Input delay DI x	89h	01h	3100h	01h

## CHD input delay

Byte	Function	Possible values:	
0	Input delay DI x	06h: 0.4ms	0Ah: 6ms
	■ Bit 3 ... 0: Values filter	07h: 0.7ms	0Bh: 12ms
		08h: 1.5ms	0Ch: 23ms
		09h: 3ms	
		Other values are not permitted!	
	■ Bit 6 ... 4: reserved		
	■ Bit 7: Filter (0: block, 1: enable)		

- By specifying the *input delay*, you can specify a filter for all channels here. With the help of filters you may e.g. filter signal peaks at a blurred input signal. By default, an input delay of 3ms is set for all channels.

### 3.14 021-1DF00 - DI 8xDC 24V Diagnosis

#### Properties

The electronic module with diagnosis collects the binary control signals from the process level and transmits them isolated to the central bus system. It has 8 digital input channels (with parameterizable input delay) and their status is monitored via LEDs.

- 8 digital inputs, isolated to the backplane bus
- Suited for switches and approximate switches
- Monitoring wire break
- Parameterizable input delay
- Diagnostics function
- Status indication of the channels via LEDs also with de-activated electronic power supply

#### Structure

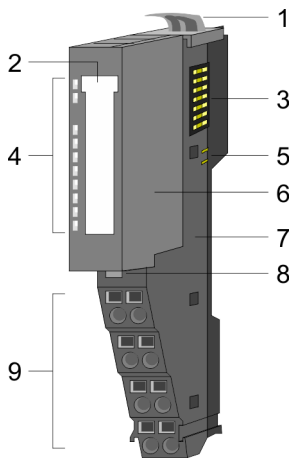

- 1 Locking lever terminal module
- 2 Labeling strip
- 3 Backplane bus
- 4 LED status indication
- 5 DC 24V power section supply
- 6 Electronic module
- 7 Terminal module
- 8 Locking lever electronic module
- 9 Terminal

#### Status indication

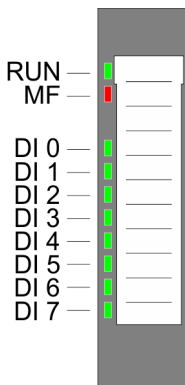

RUN	MF	DI x	Description
<input checked="" type="checkbox"/> green	<input type="checkbox"/> red	<input checked="" type="checkbox"/> green	
<input checked="" type="checkbox"/>	<input type="checkbox"/>	X	Bus communication is OK Module status is OK
<input checked="" type="checkbox"/>	<input checked="" type="checkbox"/>	X	Bus communication is OK Module status reports an error
<input type="checkbox"/>	<input checked="" type="checkbox"/>	X	Bus communication is not possible Module status reports an error
<input type="checkbox"/>	<input type="checkbox"/>	X	Error at bus power supply
X	<input checked="" type="checkbox"/> 2Hz	X	Flashing: Error in configuration <i>↪ Chap. 2.12 'Trouble shooting - LEDs' page 39</i>
<input checked="" type="checkbox"/>	<input type="checkbox"/>	<input checked="" type="checkbox"/>	Digital input has signal "1"
<input checked="" type="checkbox"/>	<input type="checkbox"/>	<input type="checkbox"/>	Digital input has signal "0"
not relevant: X			

**Pin assignment**

For wires with a cross section of 0.08mm<sup>2</sup> up to 1.5mm<sup>2</sup>.

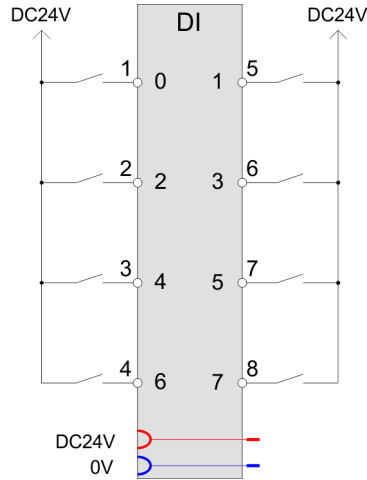
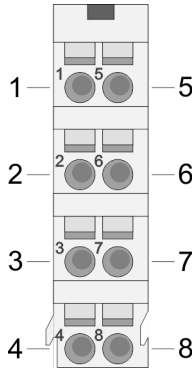

Pos.	Function	Type	Description
1	DI 0	I	Digital input DI 0
2	DI 2	I	Digital input DI 2
3	DI 4	I	Digital input DI 4
4	DI 6	I	Digital input DI 6
5	DI 1	I	Digital input DI 1
6	DI 3	I	Digital input DI 3
7	DI 5	I	Digital input DI 5
8	DI 7	I	Digital input DI 7

I: Input



To use wire break detection, there must be a minimum current of 0.5mA with signal state "0". This can be achieved by parallel connecting a resistor (22kΩ ... 47kΩ) on your switch.

**Input area**

At CPU, PROFIBUS and PROFINET the input area is embedded to the corresponding address area.

IX - Index for access via CANopen

SX - Subindex for access via EtherCAT with Index 6000h + EtherCAT-Slot

More can be found in the according manual of your bus coupler.

Addr.	Name	Bytes	Function	IX	SX
+0	PII	1	State of the inputs	6000h	
			Bit 0: DI 0		01h
			Bit 1: DI 1		02h
			Bit 2: DI 2		03h
			Bit 3: Di 3		04h
			Bit 4: DI 4		05h
			Bit 5: DI 5		06h
			Bit 6: DI 6		07h
			Bit 7: DI 7		08h

**Output area**

No byte of the output area is used by the module.

**3.14.1 Technical data**

<b>Order no.</b>	<b>021-1DF00</b>
Type	SM 021
Module ID	0012 1F41
<b>Current consumption/power loss</b>	
Current consumption from backplane bus	60 mA
Power loss	1.1 W
<b>Technical data digital inputs</b>	
Number of inputs	8
Cable length, shielded	1000 m
Cable length, unshielded	600 m
Rated load voltage	-
Current consumption from load voltage L+ (without load)	-
Rated value	DC 20.4...28.8 V
Input voltage for signal "0"	DC 0...5 V
Input voltage for signal "1"	DC 10,8...28,8 V
Input voltage hysteresis	-
Signal logic input	Sinking input
Frequency range	-
Input resistance	-
Input capacitance	-
Input current for signal "1"	3 mA
Connection of Two-Wire-BEROs possible	✓



Order no.	021-1DF00
Max. permissible BERO quiescent current	1.5 mA
Input delay of "0" to "1"	parameterizable 100µs - 20ms
Input delay of "1" to "0"	parameterizable 100µs - 20ms
Number of simultaneously utilizable inputs horizontal configuration	8
Number of simultaneously utilizable inputs vertical configuration	8
Input characteristic curve	IEC 61131-2, type 3
Initial data size	8 Bit
<b>Status information, alarms, diagnostics</b>	
Status display	green LED per channel
Interrupts	yes
Process alarm	no
Diagnostic interrupt	yes, parameterizable
Diagnostic functions	yes
Diagnostics information read-out	possible
Module state	green LED
Module error display	red LED
Channel error display	none
<b>Isolation</b>	
Between channels	-
Between channels of groups to	-
Between channels and backplane bus	✓
Insulation tested with	DC 500 V
<b>Safety</b>	
Safety protocol	-
Safety requirements	-
Secure user address	-
Watchdog	-
Two channels	-
Test pulse outputs	-
<b>Datasizes</b>	
Input bytes	1
Output bytes	0
Parameter bytes	12
Diagnostic bytes	20
<b>Housing</b>	

<b>Order no.</b>	<b>021-1DF00</b>
Material	PPE / PPE GF10
Mounting	Profile rail 35 mm
<b>Mechanical data</b>	
Dimensions (WxHxD)	12.9 mm x 109 mm x 76.5 mm
Net weight	57 g
Weight including accessories	57 g
Gross weight	71 g
<b>Environmental conditions</b>	
Operating temperature	0 °C to 60 °C
Storage temperature	-25 °C to 70 °C
<b>Certifications</b>	
UL certification	yes
KC certification	yes

### 3.14.2 Parameter data

DS - Record set for access via CPU, PROFIBUS and PROFINET

IX - Index for access via CANopen

SX - Subindex for access via EtherCAT with Index 3100h + EtherCAT-Slot

More can be found in the according manual of your bus coupler.

Name	Bytes	Function	Default	DS	IX	SX
DIAG_EN	1	Diagnostic interrupt <sup>1</sup>	00h	00h	3100h	01h
WIBRK_EN	1	Wire break recognition <sup>1</sup>	00h	00h	3101h	02h
C0_OptionNo	1	Filter time DI 0, DI 1	11h	80h	3102h	03h
C1_OptionNo	1	Filter time DI 2, DI 3	11h	81h	3103h	04h
C2_OptionNo	1	Filter time DI 4, DI 5	11h	82h	3104h	05h
C3_OptionNo	1	Filter time DI 6, DI 7	11h	83h	3105h	06h

1) This record set may only be transferred at STOP state.

#### DIAG\_EN Diagnostic interrupt

Byte	Bit 7 ... 0
0	<ul style="list-style-type: none"> <li>■ Diagnostic interrupt: <ul style="list-style-type: none"> <li>– 00h: disable</li> <li>– 40h: enable</li> </ul> </li> </ul>

■ Here you activate res. de-activate the diagnostic function.

**WIBRK\_EN Wire break recognition**

Byte	Bit 7 ... 0
0	<ul style="list-style-type: none"> <li>■ Bit 0: Wire break recognition DI 0 (1: on)</li> <li>■ Bit 1: Wire break recognition DI 1 (1: on)</li> <li>■ ...</li> <li>■ Bit 7: Wire break recognition DI 7 (1: on)</li> </ul>

- Here you activate res. de-activate the Wire break recognition.

**Cx\_OptionNo Filter time**

Byte	Function	Possible values
0	<ul style="list-style-type: none"> <li>■ Bit 3 ... 0: Filter time DI x</li> <li>■ Bit 7 ... 4: Filter time DI x+1</li> </ul>	1h: 100µs 2h: 400µs 3h: 800µs 4h: 1.6ms 5h: 3.2ms 6h: 10ms 7h: 20ms Other values are not permissible!

- *Filter time* allows you to preset a input delay for the corresponding channel x. With the help of filters you may e.g. filter signal peaks at a blurred input signal.

**3.14.3 Diagnostic data**

The following errors are listed in the diagnostics data:

- Error project engineering/parameterization
- Wire break (if parameterized)
- Internal communication error
- Internal diagnostics buffer overflow
- External power supply error

DS - Record set for access via CPU, PROFIBUS and PROFINET. The access happens by DS 01h. Additionally the first 4 bytes may be accessed by DS 00h.

IX - Index for access via CANopen. The access happens by IX 2F01h. Additionally the first 4 bytes may be accessed by IX 2F00h.

SX - Subindex for access via EtherCAT with Index 5005h.

More can be found in the according manual of your bus coupler.

Name	Bytes	Function	Default	DS	IX	SX
ERR_A	1	Diagnostic	00h	01h	2F01h	02h
MODTYP	1	Module information	1Fh			03h
ERR_C	1	reserved	00h			04h
ERR_D	1	Diagnostic	00h			05h
CHTYP	1	Channel type	70h			06h
NUMBIT	1	Number of diagnostics bits per channel	08h			07h
NUMCH	1	Number channels of the module	08h			08h
CHERR	1	Channel error	00h			09h
CH0ERR	1	Channel specific error DI 1	00h			0Ah
CH1ERR	1	Channel specific error DI 2	00h			0Bh
...		...				...
CH7ERR	1	Channel specific error DI 7	00h			11h
DIAG_US	4	µs ticker (32bit)	00h			13h

**ERR\_A Diagnostic**

Byte	Bit 7 ... 0
0	<ul style="list-style-type: none"> <li>■ Bit 0: set at module failure</li> <li>■ Bit 1: set at internal error</li> <li>■ Bit 2: set at external error</li> <li>■ Bit 3: set at channel error</li> <li>■ Bit 4: set at external auxiliary supply missing</li> <li>■ Bit 6, 5: reserved</li> <li>■ Bit 7: set at error in parameterization</li> </ul>

**MODTYP Module information**

Byte	Bit 7 ... 0
0	<ul style="list-style-type: none"> <li>■ Bit 3 ... 0: Module class                             <ul style="list-style-type: none"> <li>– 1111b: Digital module</li> </ul> </li> <li>■ Bit 4: Channel information present</li> <li>■ Bit 7 ... 5: reserved</li> </ul>

**ERR\_C reserved**

Byte	Bit 7 ... 0
0	reserved

**ERR\_D Diagnostic**

Byte	Bit 7 ... 0
0	<ul style="list-style-type: none"> <li>■ Bit 2 ... 0: reserved</li> <li>■ Bit 3: set at internal diagnostics buffer overflow</li> <li>■ Bit 4: set at internal communication error</li> <li>■ Bit 7 ... 5: reserved</li> </ul>

<b>CHTYP Channel type</b>	<b>Byte</b>	<b>Bit 7 ... 0</b>
	0	<ul style="list-style-type: none"> <li>■ Bit 6 ... 0: Channel type               <ul style="list-style-type: none"> <li>– 70h: Digital input</li> </ul> </li> <li>■ Bit 7: reserved</li> </ul>
<b>NUMBIT Diagnostic bits</b>	<b>Byte</b>	<b>Bit 7 ... 0</b>
	0	Number of diagnostics bits of the module per channel (here 08h)
<b>NUMCH Channels</b>	<b>Byte</b>	<b>Bit 7 ... 0</b>
	0	Number of channels of the module (here 08h)
<b>CHERR DI x</b>	<b>Byte</b>	<b>Bit 7 ... 0</b>
	0	<ul style="list-style-type: none"> <li>■ Bit 0: Channel error DI 0</li> <li>■ Bit 1: Channel error DI 1</li> <li>■ ...</li> <li>■ Bit 7: Channel error DI 7</li> </ul>
<b>CHxERR</b>	<b>Byte</b>	<b>Bit 7 ... 0</b>
	0	Channel-specific error: DI x: <ul style="list-style-type: none"> <li>■ Bit 0: set at error in project engineering/parameterization</li> <li>■ Bit 3 ... 1: reserved</li> <li>■ Bit 4: set at wire break</li> <li>■ Bit 7 ... 5: reserved</li> </ul>
<b>DIAG_US <math>\mu</math>s ticker</b>	<b>Byte</b>	<b>Bit 7 ... 0</b>
	0 ... 3	Value of the $\mu$ s ticker at the moment of the diagnostic

 *$\mu$ s ticker*

In the System SLIO module there is a 32 bit timer ( $\mu$ s ticker). With PowerON the timer starts counting with 0. After  $2^{32}-1\mu$ s the timer starts with 0 again.

## 4 Digital output

### 4.1 022-1BB00 - DO 2xDC 24V 0.5A

#### Properties

The electronic module accepts binary control signals from the central bus system and transfers them to the process level via outputs. It has 2 channels and their status is monitored via LEDs.

- 2 digital outputs, isolated to the backplane bus
- Status indication of the channels via LEDs

#### Structure

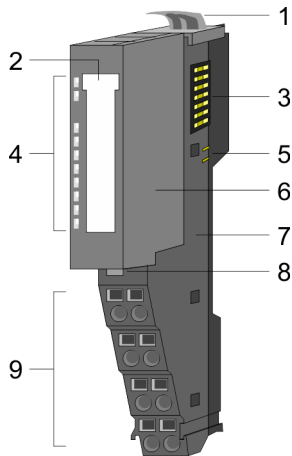

- 1 Locking lever terminal module
- 2 Labeling strip
- 3 Backplane bus
- 4 LED status indication
- 5 DC 24V power section supply
- 6 Electronic module
- 7 Terminal module
- 8 Locking lever electronic module
- 9 Terminal

#### Status indication

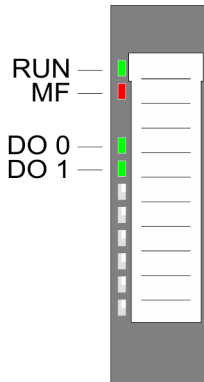

RUN	MF	DO x	Description
<input checked="" type="checkbox"/> green	<input checked="" type="checkbox"/> red	<input checked="" type="checkbox"/> green	
<input checked="" type="checkbox"/>	<input type="checkbox"/>	X	Bus communication is OK Module status is OK
<input checked="" type="checkbox"/>	<input checked="" type="checkbox"/>	X	Bus communication is OK Module status reports an error with overload, short circuit or overheat
<input type="checkbox"/>	<input checked="" type="checkbox"/>	X	Bus communication is not possible Module status reports an error with overload, short circuit or overheat
<input type="checkbox"/>	<input type="checkbox"/>	X	Error at bus power supply
X	<input checked="" type="checkbox"/> 2Hz	X	Flashing: Error in configuration <a href="#">Chap. 2.12 'Trouble shooting - LEDs' page 39</a>
<input checked="" type="checkbox"/>	<input type="checkbox"/>	<input checked="" type="checkbox"/>	Digital output has "1" signal
<input checked="" type="checkbox"/>	<input type="checkbox"/>	<input type="checkbox"/>	Digital output has "0" signal
not relevant: X			

**Pin assignment**

For wires with a cross section of 0.08mm<sup>2</sup> up to 1.5mm<sup>2</sup>.

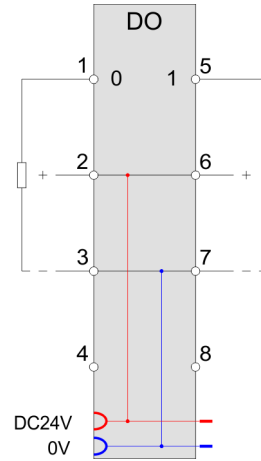
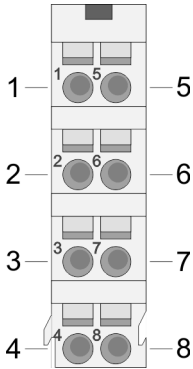

Pos.	Function	Type	Description
1	DO 0	O	Digital output DO 0
2	DC 24V	O	DC 24V
3	0V	O	GND for actuator
4	---	---	not connected
5	DO 1	O	Digital output DO 1
6	DC 24V	O	DC 24V
7	0V	O	GND for actuator
8	---	---	not connected

O: Output

**CAUTION!** Feeding in voltage at an output is not allowed and can destroy the module!

**Input area**

No byte of the input area is used by the module.

**Output area**

At CPU, PROFIBUS and PROFINET the output area is embedded to the corresponding address area.

IX - Index for access via CANopen

SX - Subindex for access via EtherCAT with Index 7000h + EtherCAT-Slot

More can be found in the according manual of your bus coupler.

Addr.	Name	Bytes	Function	IX	SX
+0	PIQ	1	State of the outputs	5200h	
			Bit 0: DO 0		01h
			Bit 1: DO 1		02h
			Bit 7 ... 2: reserved		

#### 4.1.1 Technical data

<b>Order no.</b>	<b>022-1BB00</b>
Type	SM 022
Module ID	0101 AF90
<b>Current consumption/power loss</b>	
Current consumption from backplane bus	70 mA
Power loss	0.4 W
<b>Technical data digital outputs</b>	
Number of outputs	2
Cable length, shielded	1000 m
Cable length, unshielded	600 m
Rated load voltage	DC 20.4...28.8 V
Current consumption from load voltage L+ (without load)	5 mA
Total current per group, horizontal configuration, 40°C	1 A
Total current per group, horizontal configuration, 60°C	1 A
Total current per group, vertical configuration	1 A
Output current at signal "1", rated value	0.5 A
Signal logic output	Sourcing output
Output delay of "0" to "1"	30 µs
Output delay of "1" to "0"	175 µs
Minimum load current	-
Lamp load	10 W
Parallel switching of outputs for redundant control of a load	not possible
Parallel switching of outputs for increased power	not possible
Actuation of digital input	✓
Switching frequency with resistive load	max. 1000 Hz
Switching frequency with inductive load	max. 0.5 Hz
Switching frequency on lamp load	max. 10 Hz
Internal limitation of inductive shut-off voltage	L+ (-45 V)
Short-circuit protection of output	yes, electronic



Order no.	022-1BB00
Trigger level	1 A
Number of operating cycle of relay outputs	-
Switching capacity of contacts	-
Output data size	2 Bit
<b>Status information, alarms, diagnostics</b>	
Status display	green LED per channel
Interrupts	no
Process alarm	no
Diagnostic interrupt	no
Diagnostic functions	no
Diagnostics information read-out	none
Supply voltage display	green LED
Group error display	red LED
Channel error display	none
<b>Isolation</b>	
Between channels	-
Between channels of groups to	-
Between channels and backplane bus	✓
Insulation tested with	DC 500 V
<b>PWM data</b>	
PWM channels	-
PWM time basis	-
Period length	-
Minimum pulse width	-
Type of output	-
<b>Safety</b>	
Safety protocol	-
Safety requirements	-
Secure user address	-
Watchdog	-
Two channels	-
Test pulse length	-
Circuit monitoring	-
<b>Datasizes</b>	
Input bytes	0
Output bytes	1

022-1BB00 - DO 2xDC 24V 0.5A &gt; Technical data

<b>Order no.</b>	<b>022-1BB00</b>
Parameter bytes	0
Diagnostic bytes	0
<b>Housing</b>	
Material	PPE / PPE GF10
Mounting	Profile rail 35 mm
<b>Mechanical data</b>	
Dimensions (WxHxD)	12.9 mm x 109 mm x 76.5 mm
Net weight	58 g
Weight including accessories	58 g
Gross weight	72 g
<b>Environmental conditions</b>	
Operating temperature	0 °C to 60 °C
Storage temperature	-25 °C to 70 °C
<b>Certifications</b>	
UL certification	yes
KC certification	yes

## 4.2 022-1BB20 - DO 2xDC 24V 2A

### Properties

The electronic module accepts binary control signals from the central bus system and transfers them to the process level via outputs. It has 2 channels and their status is monitored via LEDs.

- 2 digital 2A outputs, isolated to the backplane bus
- Status indication of the channels via LEDs

### Structure

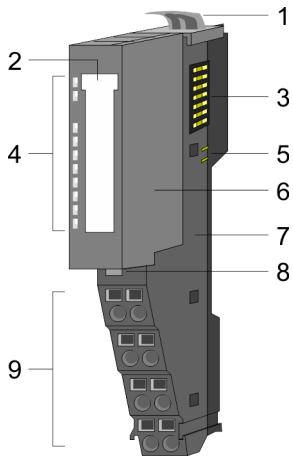

- 1 Locking lever terminal module
- 2 Labeling strip
- 3 Backplane bus
- 4 LED status indication
- 5 DC 24V power section supply
- 6 Electronic module
- 7 Terminal module
- 8 Locking lever electronic module
- 9 Terminal

### Status indication

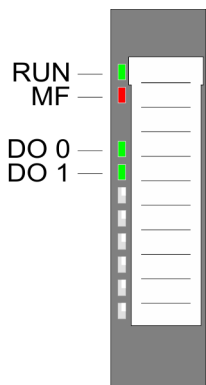

RUN	MF	DO x	Description
<input checked="" type="checkbox"/> green	<input checked="" type="checkbox"/> red	<input checked="" type="checkbox"/> green	
<input checked="" type="checkbox"/>	<input type="checkbox"/>	X	Bus communication is OK Module status is OK
<input checked="" type="checkbox"/>	<input checked="" type="checkbox"/>	X	Bus communication is OK Module status reports an error with overload, short circuit or overheat
<input type="checkbox"/>	<input checked="" type="checkbox"/>	X	Bus communication is not possible Module status reports an error with overload, short circuit or overheat
<input type="checkbox"/>	<input type="checkbox"/>	X	Error at bus power supply
X	<input checked="" type="checkbox"/> 2Hz	X	Flashing: Error in configuration <a href="#">Chap. 2.12 'Trouble shooting - LEDs' page 39</a>
<input checked="" type="checkbox"/>	<input type="checkbox"/>	<input checked="" type="checkbox"/>	Digital output has "1" signal
<input checked="" type="checkbox"/>	<input type="checkbox"/>	<input type="checkbox"/>	Digital output has "0" signal
not relevant: X			

**Pin assignment**

For wires with a cross section of 0.08mm<sup>2</sup> up to 1.5mm<sup>2</sup>.

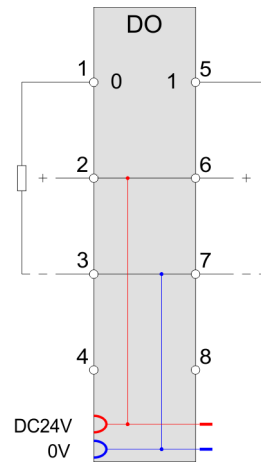
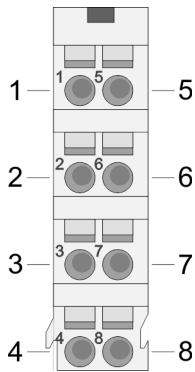

Pos.	Function	Type	Description
1	DO 0	O	Digital output DO 0
2	DC 24V	O	DC 24V
3	0V	O	GND for actuator
4	---	---	not connected
5	DO 1	O	Digital output DO 1
6	DC 24V	O	DC 24V
7	0V	O	GND for actuator
8	---	---	not connected

O: Output



**CAUTION!**  
Feeding in voltage at an output is not allowed and can destroy the module!

**Input area**

No byte of the input area is used by the module.

**Output area**

At CPU, PROFIBUS and PROFINET the output area is embedded to the corresponding address area.

IX - Index for access via CANopen

SX - Subindex for access via EtherCAT with Index 7000h + EtherCAT-Slot

More can be found in the according manual of your bus coupler.

Addr.	Name	Bytes	Function	IX	SX
+0	PIQ	1	State of the outputs	5200h	
			Bit 0: DO 0		01h
			Bit 1: DO 1		02h
			Bit 7 ... 2: reserved		

#### 4.2.1 Technical data

<b>Order no.</b>	<b>022-1BB20</b>
Type	SM 022
Module ID	0102 AF90
<b>Current consumption/power loss</b>	
Current consumption from backplane bus	70 mA
Power loss	0.55 W
<b>Technical data digital outputs</b>	
Number of outputs	2
Cable length, shielded	1000 m
Cable length, unshielded	600 m
Rated load voltage	DC 20.4...28.8 V
Current consumption from load voltage L+ (without load)	10 mA
Total current per group, horizontal configuration, 40°C	4 A
Total current per group, horizontal configuration, 60°C	4 A
Total current per group, vertical configuration	4 A
Output current at signal "1", rated value	2 A
Signal logic output	Sourcing output
Output delay of "0" to "1"	100 µs
Output delay of "1" to "0"	250 µs
Minimum load current	-
Lamp load	10 W
Parallel switching of outputs for redundant control of a load	not possible
Parallel switching of outputs for increased power	not possible
Actuation of digital input	✓
Switching frequency with resistive load	max. 1000 Hz
Switching frequency with inductive load	max. 0.5 Hz
Switching frequency on lamp load	max. 10 Hz
Internal limitation of inductive shut-off voltage	L+ (-52 V)
Short-circuit protection of output	yes, electronic

Order no.	022-1BB20
Trigger level	2.7 A
Number of operating cycle of relay outputs	-
Switching capacity of contacts	-
Output data size	2 Bit
<b>Status information, alarms, diagnostics</b>	
Status display	green LED per channel
Interrupts	no
Process alarm	no
Diagnostic interrupt	no
Diagnostic functions	no
Diagnostics information read-out	none
Supply voltage display	green LED
Group error display	red LED
Channel error display	none
<b>Isolation</b>	
Between channels	-
Between channels of groups to	-
Between channels and backplane bus	✓
Insulation tested with	DC 500 V
<b>PWM data</b>	
PWM channels	-
PWM time basis	-
Period length	-
Minimum pulse width	-
Type of output	-
<b>Safety</b>	
Safety protocol	-
Safety requirements	-
Secure user address	-
Watchdog	-
Two channels	-
Test pulse length	-
Circuit monitoring	-
<b>Datasizes</b>	
Input bytes	0
Output bytes	1

<b>Order no.</b>	<b>022-1BB20</b>
Parameter bytes	0
Diagnostic bytes	0
<b>Housing</b>	
Material	PPE / PPE GF10
Mounting	Profile rail 35 mm
<b>Mechanical data</b>	
Dimensions (WxHxD)	12.9 mm x 109 mm x 76.5 mm
Net weight	57 g
Weight including accessories	57 g
Gross weight	71 g
<b>Environmental conditions</b>	
Operating temperature	0 °C to 60 °C
Storage temperature	-25 °C to 70 °C
<b>Certifications</b>	
UL certification	yes
KC certification	yes

### 4.3 022-1BB70 - DO 2xDC 24V 0.5A ETS

#### Properties

The electronic module accepts binary control signals from the central bus system and transfers them time-controlled by means of ETS functionality to the process level via outputs. It has 2 channels and their status is monitored via LEDs. With configured ETS functionality (ETS = edge time stamp) depending on the configuration 5 (20byte) respectively 15 (60byte), you may transfer the states for the outputs together with a time value of the  $\mu$ s ticker as an ETS entry to the FIFO stack. The FIFO memory serves for space for max. 31 ETS entries.

- 2 digital outputs, isolated to the backplane bus
- FIFO stack for 5 respectively 15 ETS entries (each 4byte)
- Diagnostics function
- Controlling by process image respectively handling blocks
- Status indication of the channels via LEDs

#### Structure

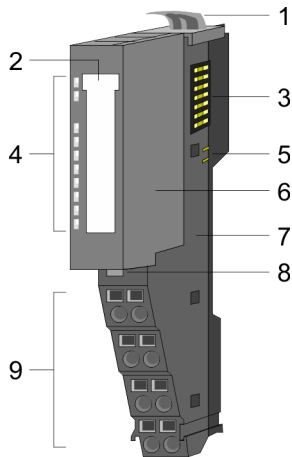

- 1 Locking lever terminal module
- 2 Labeling strip
- 3 Backplane bus
- 4 LED status indication
- 5 DC 24V power section supply
- 6 Electronic module
- 7 Terminal module
- 8 Locking lever electronic module
- 9 Terminal

#### Status indication

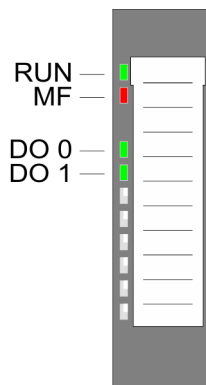

RUN	MF	DO x	Description
<input checked="" type="checkbox"/> green	<input checked="" type="checkbox"/> red	<input checked="" type="checkbox"/> green	
<input checked="" type="checkbox"/>	<input type="checkbox"/>	X	Bus communication is OK Module status is OK
<input checked="" type="checkbox"/>	<input checked="" type="checkbox"/>	X	Bus communication is OK Module status reports an error with overload, short circuit or overheat
<input type="checkbox"/>	<input checked="" type="checkbox"/>	X	Bus communication is not possible Module status reports an error with overload, short circuit or overheat
<input type="checkbox"/>	<input type="checkbox"/>	X	Error at bus power supply
X	<input checked="" type="checkbox"/> 2Hz	X	Flashing: Error in configuration <a href="#">Chap. 2.12 'Trouble shooting - LEDs'</a> page 39
<input checked="" type="checkbox"/>	<input type="checkbox"/>	<input checked="" type="checkbox"/>	Digital output has "1" signal
<input checked="" type="checkbox"/>	<input type="checkbox"/>	<input type="checkbox"/>	Digital output has "0" signal
not relevant: X			



## Pin assignment

For wires with a cross section of 0.08mm<sup>2</sup> up to 1.5mm<sup>2</sup>.

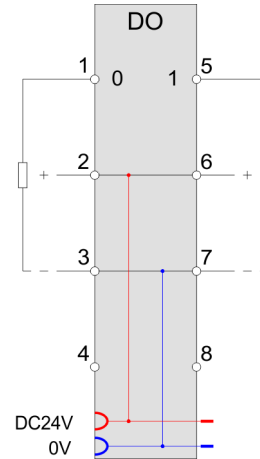
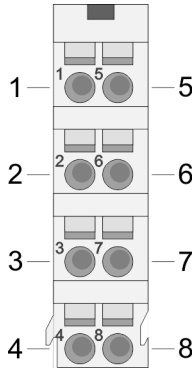

Pos.	Function	Type	Description
1	DO 0	O	Digital output DO 0
2	DC 24V	O	DC 24V
3	0V	O	GND for actuator
4	—	—	not connected
5	DO 1	O	Digital output DO 1
6	DC 24V	O	DC 24V
7	0V	O	GND for actuator
8	—	—	not connected

O: Output

**CAUTION!**

Feeding in voltage at an output is not allowed and can destroy the module!

## In-/Output area

With configured ETS functionality (ETS=edge time stamp) a time value (ETS\_US) together with the state of the outputs (PIQ) and a running number (RN) may be stored as ETS entry in the process image.

You may configure the following variants:

- 022-1BB70 DO 2xDC 24V (20): FIFO with 20byte for 5 ETS entries
- 022-1BB70 DO 2xDC 24V (60): FIFO with 60byte for 15 ETS entries



Please consider, with a full FIFO stack no further ETS entries may be accepted. To ensure that your ETS entries are kept, you should always check the state of the FIFO stack by STS\_FIFO in the input area before.

**Input area 4byte**

The input range is used for status message. At CPU, PROFIBUS and PROFINET the input area is embedded to the corresponding address area.

IX - IX = Index for access via CANopen.

SX - Subindex for access via EtherCAT with Index 6000h + EtherCAT-Slot

More can be found in the according manual of your bus coupler.

Addr.	Name	Bytes	Function	IX	SX
+0	RN_LAST	1	Bit 5 ... 0: RN last FIFO entry Bit 6: 1 (fix) Bit 7: 0 (fix)	5440h	01h
+1	RN_NEXT	1	Bit 5 ... 0: RN next FIFO entry to be processed Bit 6: 1 (fix) Bit 7: 1 (fix)		02h
+2	STS_FIFO	1	State of the FIFO stack		03h
+3	NUM_ETS	1	Number of ETS entries in the FIFO stack		04h

**RN\_LAST**

Bit 5 ... 0: Here the RN of the last ETS entry may be found, which was recognized as valid and written into the FIFO memory of the module.

Bit 6: 1 (fix) - serves for the identification in the process image

Bit 7: 0 (fix) - serves for the identification in the process image

**RN\_NEXT**

Bit 5 ... 0: Here the RN of the ETS entry may be found, which will be executed next in the FIFO memory of the module. Please consider Bit 6 and 7 of RN\_NEXT are always set.

Bit 6: 1 (fix) - serves for the identification in the process image

Bit 7: 1 (fix) - serves for the identification in the process image

**STS\_FIFO**

The *State* informs about the state of the FIFO stack:

STS_FIFO	Description
00h/80h	Everything is OK. You will get this message directly after the storage in the FIFO memory of the module.
01h/81h	There is no following ETS entry in the FIFO. The RN does not correspond to the expected RN. Please check your RN in the output area.
02h/82h	There are no new ETS entries in the FIFO.
03h/83h	FIFO stack is full. There is no more place for further ETS entries.

If there are less ETS entries written as possible, additionally bit 6 of the last RN must be set. This is necessary; otherwise you have to overwrite the following entries with a "not valid" entry.

The module ignores entries after an entry with a set bit 6. If there is an ETS entry in the FIFO memory, whose bit 6 is set, STS\_FIFO is always returned ored with 80h.

**NUM\_ETTS**

Here always the current number of the ETS entries in the FIFO memory of the module may be found.

**Structure of an ETS entry**

Depending on the configuration up to 15 ETS entries may be written via the output area. Each ETS entry uses 4byte in the process image:

Addr.	Name	Bytes	Function	IX	SX
+0	PIQ	1	Output byte	5640h/s	01h
+1	RN	1	Running number		02h
+2	ETS_US	2	µs ticker		03h

**PIQ**

Here the state of the outputs for the corresponding time may be defined and the output channels may be enabled respectively disabled.

The output byte has the following bit allocation:

- Bit 3 ... 0: 0 (fix)
- Bit 4: Enable DO 1 (0: disable, 1: enable)
- Bit 5: Enable DO 0 (0: disable, 1: enable)
- Bit 6: State DO 1
- Bit 7: State DO 0

**Time characteristics of an output**

The simultaneous enabling and state change of an output should be avoided. Due to the different run times (see times A, B and C) up to the change of state this may affect unwanted switching effects.

The following figure shows the time characteristics of an output when using the enable bit.

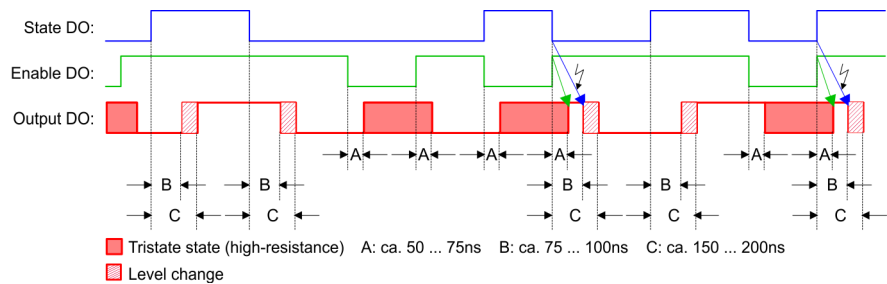

**RN**

RN (Running Number) is a continuous number 0 ... 63, which has to start with 1. With the RN the chronological order of the ETS entries may be defined. With each ETS entry RN is to be incremented, otherwise the ETS entry may not be recognized by the module.



*If there are less ETS entries written as possible, additionally bit 6 of the last RN must be set. This is necessary; otherwise you have to overwrite the following entries with a "not valid" entry. The module ignores entries after an entry with a set bit 6.*

**ETS\_US**

In the System SLIO module there is a 32 bit timer ( $\mu$ s ticker). With PowerON the timer starts counting. After  $2^{32}-1\mu$ s the timer starts with 0 again. For ETS\_US of an ETS entry you have to define a time value from the low word of the  $\mu$ s ticker (0...65535 $\mu$ s).

Here please enter a time value in  $\mu$ s, to which the state of the outputs is to be taken.  
Range of values: 0 ... 65535

**ETS functionality**

The following picture shows how the ETS entries are to be preset in the output area, so that these can be stored in the FIFO memory.

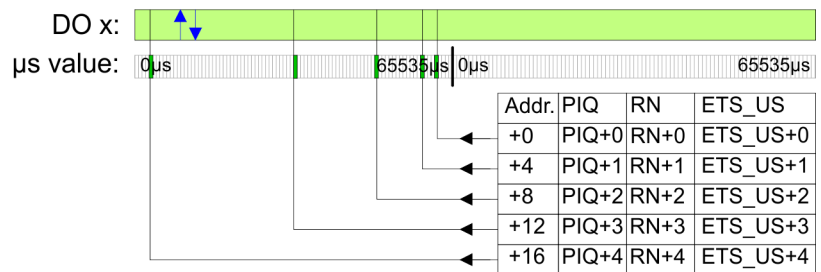

**Output area 20byte respectively 60byte**

At CPU, PROFIBUS and PROFINET the output area is embedded to the corresponding address area.

IX - Index for access via CANopen. With s = Subindex the corresponding ETS entry is addressed.

SX - Subindex for access via EtherCAT with Index 7000h + EtherCAT-Slot

More can be found in the according manual of your bus coupler.

**Configured as 022-1BB70**

DO 2xDC 24V (20)  
20byte - 5 ETS entries

Addr.	PIQ	IX=5640h	SX	Addr.	RN	IX=5640h	SX	Addr.	ETS-US	IX=5640h	SX
+0	PIQ+0	s=1	01h	+1	RN+0	s=1	02h	+2	ETS_US+0	s=1	03h
+4	PIQ+1	s=2	04h	+5	RN+1	s=2	05h	+6	ETS_US+1	s=2	06h
+8	PIQ+2	s=3	07h	+9	RN+2	s=3	08h	+10	ETS_US+2	s=3	09h
+12	PIQ+3	s=4	0Ah	+13	RN+3	s=4	0Bh	+14	ETS_US+3	s=4	0Ch
+16	PIQ+4	s=5	0Dh	+17	RN+4	s=5	0Eh	+18	ETS_US+4	s=5	0Fh

**Configured as 022-1BB70** DO 2xDC 24V (60)  
60byte - 15 ETS entries

Addr.	PIQ	IX=5640h	SX	Addr.	RN	IX=5640h	SX	Addr.	ETS-US	IX=5640h	SX
+0	PIQ+0	s=1	01h	+1	RN+0	s=1	02h	+2	ETS_US+0	s=1	03h
+4	PIQ+1	s=2	04h	+5	RN+1	s=2	05h	+6	ETS_US+1	s=2	06h
+8	PIQ+2	s=3	07h	+9	RN+2	s=3	08h	+10	ETS_US+2	s=3	09h
+12	PIQ+3	s=4	0Ah	+13	RN+3	s=4	0Bh	+14	ETS_US+3	s=4	0Ch
+16	PIQ+4	s=5	0Dh	+17	RN+4	s=5	0Eh	+18	ETS_US+4	s=5	0Fh
+20	PIQ+5	s=6	10h	+21	RN+5	s=6	11h	+22	ETS_US+5	s=6	12h
+24	PIQ+6	s=7	13h	+25	RN+6	s=7	14h	+26	ETS_US+6	s=7	15h
+28	PIQ+7	s=8	16h	+29	RN+7	s=8	17h	+30	ETS_US+7	s=8	18h
+32	PIQ+8	s=9	19h	+33	RN+8	s=9	1Ah	+34	ETS_US+8	s=9	1Bh
+36	PIQ+9	s=10	1Ch	+37	RN+9	s=10	1Dh	+38	ETS_US+9	s=10	1Eh
+40	PIQ+10	s=11	1Fh	+41	RN+10	s=11	20h	+42	ETS_US+10	s=11	21h
+44	PIQ+11	s=12	22h	+45	RN+11	s=12	23h	+46	ETS_US+11	s=12	24h
+48	PIQ+12	s=13	25h	+49	RN+12	s=13	26h	+50	ETS_US+12	s=13	27h
+52	PIQ+13	s=14	28h	+53	RN+13	s=14	29h	+54	ETS_US+13	s=14	2Ah
+56	PIQ+14	s=15	2Bh	+57	RN+14	s=15	2Ch	+58	ETS_US+14	s=15	2Dh



*The ETS module may only be accessed by the System System SLIO CPU by means of SFC 15 or via the process image. Only the input data of the ETS module may be read by individual accesses.*

## 4.3.1 Technical data

Order no.	022-1BB70
Type	SM 022
Module ID	0F41 57E1
<b>Current consumption/power loss</b>	
Current consumption from backplane bus	105 mA
Power loss	0.95 W
<b>Technical data digital outputs</b>	
Number of outputs	2
Cable length, shielded	1000 m
Cable length, unshielded	600 m
Rated load voltage	DC 20.4...28.8 V
Current consumption from load voltage L+ (without load)	15 mA
Total current per group, horizontal configuration, 40°C	1 A
Total current per group, horizontal configuration, 60°C	1 A
Total current per group, vertical configuration	1 A
Output current at signal "1", rated value	0.5 A
Signal logic output	Sourcing output
Output delay of "0" to "1"	max. 100 ns
Output delay of "1" to "0"	max. 100 ns
Minimum load current	-
Lamp load	10 W
Parallel switching of outputs for redundant control of a load	not possible
Parallel switching of outputs for increased power	not possible
Actuation of digital input	✓
Switching frequency with resistive load	max. 40 kHz
Switching frequency with inductive load	max. 40 kHz
Switching frequency on lamp load	max. 40 kHz
Internal limitation of inductive shut-off voltage	L+ (-52 V)
Short-circuit protection of output	yes, electronic, and only highside
Trigger level	2.5 A
Number of operating cycle of relay outputs	-
Switching capacity of contacts	-
Output data size	60 Byte
<b>Status information, alarms, diagnostics</b>	
Status display	green LED per channel
Interrupts	no

Order no.	022-1BB70
Process alarm	no
Diagnostic interrupt	no
Diagnostic functions	no
Diagnostics information read-out	possible
Supply voltage display	green LED
Group error display	red LED
Channel error display	none
<b>Isolation</b>	
Between channels	-
Between channels of groups to	-
Between channels and backplane bus	✓
Insulation tested with	DC 500 V
<b>PWM data</b>	
PWM channels	-
PWM time basis	-
Period length	-
Minimum pulse width	-
Type of output	-
<b>Safety</b>	
Safety protocol	-
Safety requirements	-
Secure user address	-
Watchdog	-
Two channels	-
Test pulse length	-
Circuit monitoring	-
<b>Datasizes</b>	
Input bytes	4
Output bytes	20 / 60
Parameter bytes	6
Diagnostic bytes	20
<b>Housing</b>	
Material	PPE / PPE GF10
Mounting	Profile rail 35 mm
<b>Mechanical data</b>	
Dimensions (WxHxD)	12.9 mm x 109 mm x 76.5 mm

<b>Order no.</b>	<b>022-1BB70</b>
Net weight	61 g
Weight including accessories	61 g
Gross weight	75 g
<b>Environmental conditions</b>	
Operating temperature	0 °C to 60 °C
Storage temperature	-25 °C to 70 °C
<b>Certifications</b>	
UL certification	yes
KC certification	yes

### 4.3.2 Parameter data

#### 4.3.2.1 Parameters

The module has the following parameter data, which were fix set and may not be altered.

DS - Record set for access via CPU, PROFIBUS and PROFINET

IX - Index for access via CANopen

SX - Subindex for access via EtherCAT with Index 3100h + EtherCAT-Slot

More can be found in the according manual of your bus coupler.

Name	Bytes	Function	Default	DS	IX	SX
PII_L	1	Length process image input data <sup>1</sup>	04h (fix)	02h	3100h	01h
PIQ_L	1	Length process image output data <sup>1,2</sup>	14h resp. 3Ch (fix)	02h	3101h	02h

1) This record set may only be transferred at STOP state.

2) This parameter depends on the configured variant.

<b>PII_L</b>	<b>Byte</b>	<b>Bit 7 ... 0</b>
	0	The length of the process image of the input data is fix set to 4byte.

<b>PIQ_L</b>	<b>Byte</b>	<b>Bit 7 ... 0</b>
	0	The length of the process image of the output data is fix set to the configured variant (14h or 3Ch).



4.3.2.2 Example for the principle of operation

**ETS values**

In the following it is demonstrated by an example, in which order the ETS entries are stored and processed.

With this example a module is configured, which uses 20byte for 5 ETS entries in the output area PIQ.

With the following times of the  $\mu$ s ticker the following states of the outputs should be taken:

RN	ETS_US in $\mu$ s	PIQ DO 0 (Bit 7)	PIQ DO 1 (Bit 6)	PIQ enable DO 0 (Bit 5)	PIQ enable DO 1 (Bit 4)
01h	6000	0	0	1	1
02h	12506	1	0	1	1
03h	34518	1	1	1	1
04h	49526	0	0	1	1
05h	54529	0	1	1	1
06h	3500	1	1	1	1
07h	12443	1	0	1	1
08h	20185	0	0	1	1
09h	30140	1	0	1	1
0Ah	37330	0	0	1	1
0Bh	40000	0	0	0	0

**Time diagram**

From the table you get the following time diagram:

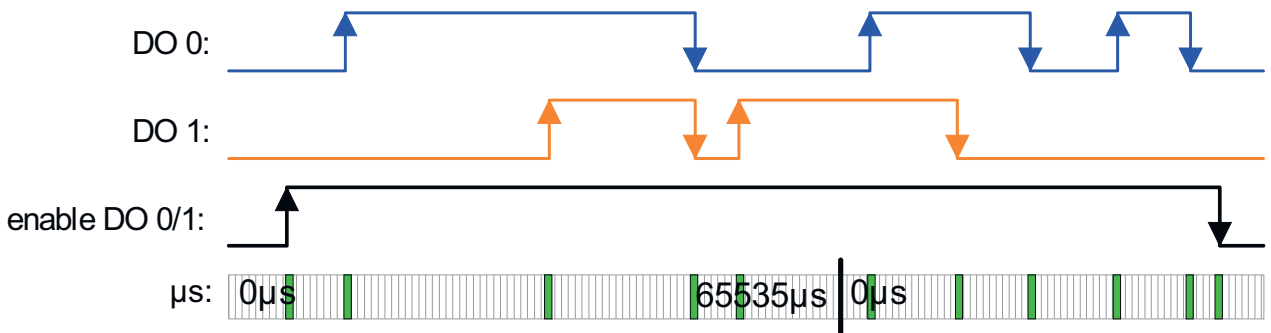

**Writing 5 ETS entries**

After writing the ETS entries into the process output image they are directly stored in the FIFO memory of the module.

The state of the outputs are shown in the diagram at the time "t".

In the PII you will find the status bytes.

Addr.	PIQ	RN	ETS_US	→	FIFO	PIQ	RN	ETS_US	PII
+0	00110000	01h	6000		1	00110000	01h	6000	RN_LAST: 45h
+4	10110000	02h	12506		2	10110000	02h	12506	RN_NEXT: C1h
+8	11110000	03h	34518		3	11110000	03h	34518	STS_FIFO: 00h
+12	00110000	04h	49526		4	00110000	04h	49526	NUM_ETS: 05h
+16	01110000	05h	54529		5	01110000	05h	54529	
					6	00000000	00h	0	
					7	00000000	00h	0	
					8	00000000	00h	0	
					9	00000000	00h	0	
					...	00000000	00h	0	
					31	00000000	00h	0	

**Executing ETS function for RN = 01h**

So that the outputs can be controlled, they must be enabled before. In this example both outputs are enabled with the 1. RN.

The ETS entry (RN = 01h) is executed and deleted in the FIFO.

Addr.	PIQ	RN	ETS_US	→	FIFO	PIQ	RN	ETS_US	PII
+0	00110000	01h	6000		1	10110000	02h	12506	RN_LAST: 45h
+4	10110000	02h	12506		2	11110000	03h	34518	RN_NEXT: C2h
+8	11110000	03h	34518		3	00110000	04h	49526	STS_FIFO: 00h/02h
+12	00110000	04h	49526		4	01110000	05h	54529	NUM_ETS: 04h
+16	01110000	05h	54529		5	00000000	00h	0	
					6	00000000	00h	0	
					7	00000000	00h	0	
					8	00000000	00h	0	
					9	00000000	00h	0	
					...	00000000	00h	0	
					31	00000000	00h	0	

**Executing ETS function for RN = 02h ... 04h**

The states of RN = 02h ... RN 04h are successively issued and deleted in the FIFO.

Addr.	PIQ	RN	ETS_US	→	FIFO	PIQ	RN	ETS_US	PII
+0	00110000	01h	6000		1	01110000	05h	54529	RN_LAST: 45h
+4	10110000	02h	12506		2	00000000	00h	0	RN_NEXT: C5h
+8	11110000	03h	34518		3	00000000	00h	0	STS_FIFO: 00h/02h
+12	00110000	04h	49526		4	00000000	00h	0	NUM_ETS: 01h
+16	01110000	05h	54529		5	00000000	00h	0	
					6	00000000	00h	0	
					7	00000000	00h	0	
					8	00000000	00h	0	
					9	00000000	00h	0	
					...	00000000	00h	0	
					31	00000000	00h	0	

**Writing 5 ETS entries**

After writing the next 5 ETS entries into the process output image they are directly stored in the FIFO memory of the module.

Addr.	PIQ	RN	ETS_US	→	FIFO	PIQ	RN	ETS_US	PII
+0	11110000	06h	3500		1	01110000	05h	54529	RN_LAST: 4Ah
+4	10110000	07h	12443		2	11110000	06h	3500	RN_NEXT: C5h
+8	00110000	08h	20185		3	10110000	07h	12443	STS_FIFO: 00h/02h
+12	10110000	09h	30140		4	00110000	08h	20185	NUM_ETS: 06h
+16	00110000	0Ah	37330		5	10110000	09h	30140	
					6	00110000	0Ah	37330	
					7	00000000	00h	0	
					8	00000000	00h	0	
					9	00000000	00h	0	
					...	00000000	00h	0	
					31	00000000	00h	0	

**Executing ETS function for RN = 06h ... 08h**

The states of RN = 06h ... RN 08h are successively issued and deleted in the FIFO.

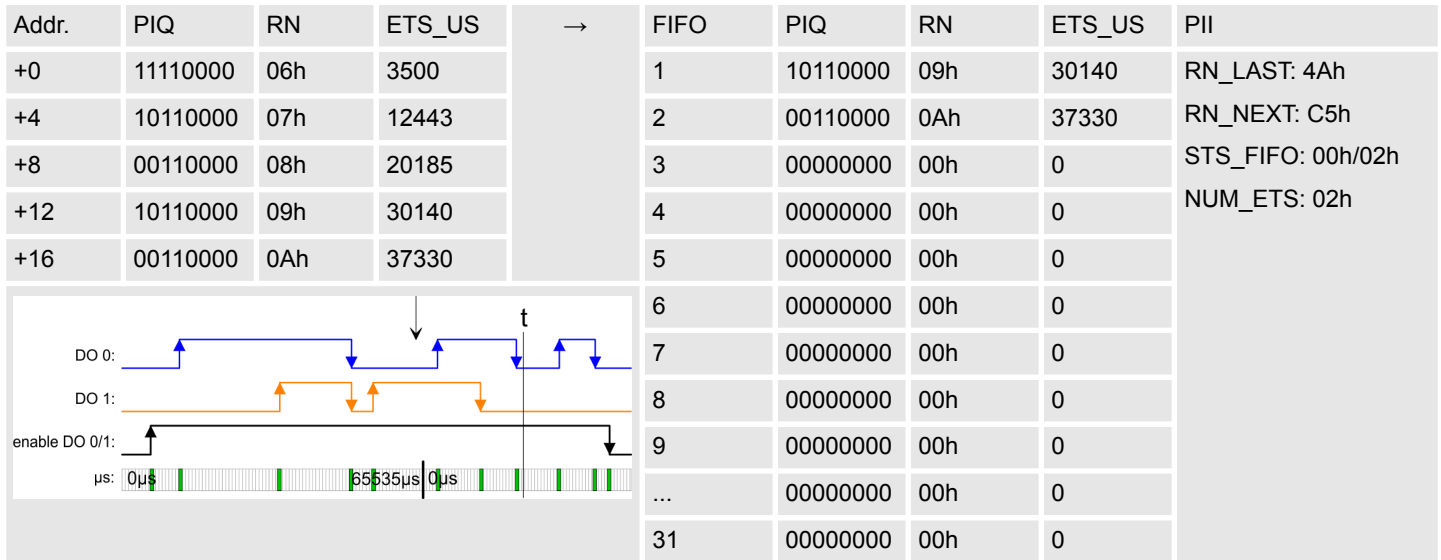

**Writing last ETS entry**

Since less than 5 ETS entries are written, bit 6 of RN of the last ETS entry must always be set. RN = 0Bh becomes 4Bh.

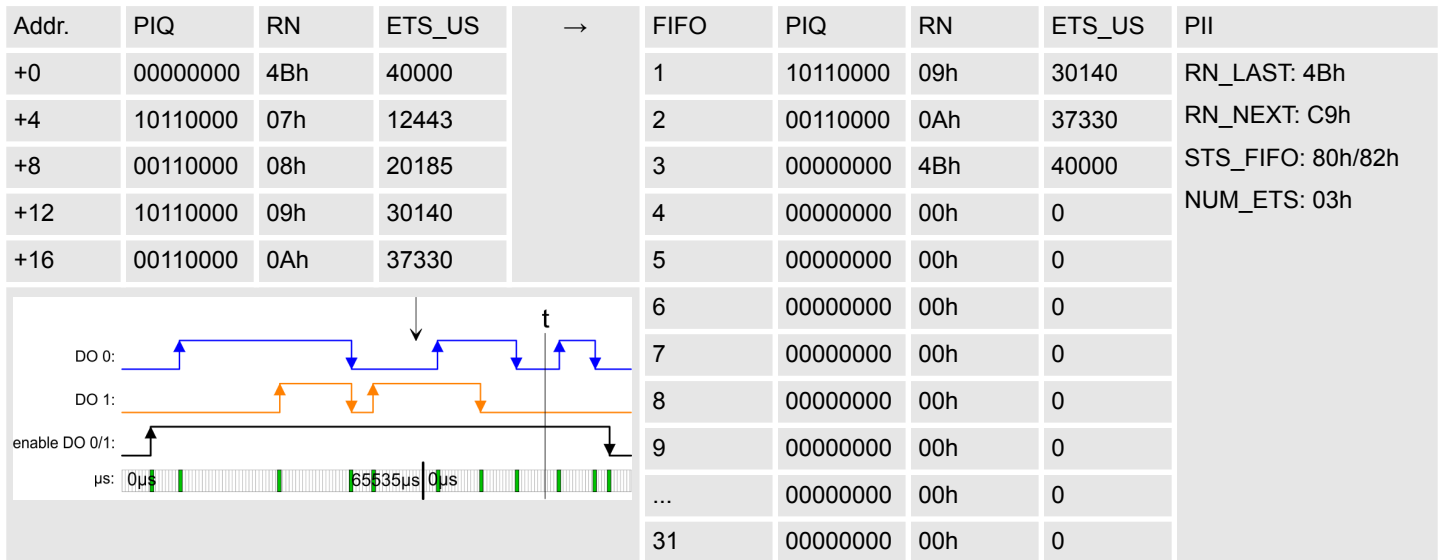

**Executing ETS function for RN = 09h ... 4Bh**

The states of RN = 09h ... RN 4Bh are successively issued and deleted in the FIFO.

Addr.	PIQ	RN	ETS_US	→	FIFO	PIQ	RN	ETS_US	PII
+0	00000000	4Bh	40000		1	00000000	00h	0	RN_LAST: 4Bh
+4	10110000	07h	12443		2	00000000	00h	0	RN_NEXT: CCh
+8	00110000	08h	20185		3	00000000	00h	0	STS_FIFO: 80h/82h
+12	10110000	09h	30140		4	00000000	00h	0	NUM_ETS: 00h
+16	00110000	0Ah	37330		5	00000000	00h	0	
					6	00000000	00h	0	
					7	00000000	00h	0	
					8	00000000	00h	0	
					9	00000000	00h	0	
					...	00000000	00h	0	
					31	00000000	00h	0	

**i** Please consider the ETS modules can only effectively be used together with head modules, which have an integrated µs ticker. The Ethernet coupler with ModbusTCP 053-1MT00 for example does not have an µs ticker.

**4.3.3 Diagnostic data**

This module does not support interrupt functions, the diagnostic data serve the information about this module.

DS - Record set for access via CPU, PROFIBUS and PROFINET. The access happens by DS 01h. Additionally the first 4 bytes may be accessed by DS 00h.

IX - Index for access via CANopen. The access happens by IX 2F01h. Additionally the first 4 bytes may be accessed by IX 2F00h.

SX - Subindex for access via EtherCAT with Index 5005h.

More can be found in the according manual of your bus coupler.

022-1BB70 - DO 2xDC 24V 0.5A ETS > Diagnostic data

Name	Bytes	Function	Default	DS	IX	SX
ERR_A	1	reserved	00h	01h	2F01h	02h
MODTYP	1	Module information	1Fh			03h
ERR_C	1	reserved	00h			04h
ERR_D	1	reserved	00h			05h
CHTYP	1	Channel type	72h			06h
NUMBIT	1	Number of diagnostics bits per channel	00h			07h
NUMCH	1	Number channels of the module	02h			08h
CHERR	1	reserved	00h			09h
CH0ERR... CH7ERR	8	reserved	00h			0Ah ... 11h
DIAG_US	4	µs ticker (32bit)	00h			13h

**MODTYP Module information**

Byte	Bit 7 ... 0
0	Bit 3 ... 0: Module class 1111b Digital module Bit 4: Channel information present Bit 7 ... 5: reserved

**CHTYP Channel type**

Byte	Bit 7 ... 0
0	Bit 6 ... 0: Channel type 72h: Digital output Bit 7: 0 (fix)

**NUMBIT Diagnostic bits**

Byte	Bit 7 ... 0
0	Number of diagnostics bits of the module per channel (here 00h)

**NUMCH Number of channels**

Byte	Bit 7 ... 0
0	Number of channels of the module (here 02h)

**DIAG\_US µs ticker**

Byte	Bit 7 ... 0
0 ... 3	Value of the µs ticker at the moment of the diagnostic data generation

**ERR\_A/C/D CHERR, CHxERR reserved**

Byte	Bit 7 ... 0
0	reserved

### 4.4 022-1BB90 - DO 2xDC 24V 0.5A PWM

**Properties**

The electronic has 2 output channels with PWM functionality (PWM = **p**ulse **w**idth **m**odulation). By presetting of time parameter a pulse sequence with according pulse/break ratio may be issued at the corresponding output channel.

- 2 PWM outputs, isolated to the backplane bus
- PWM outputs switchable between *push/pull* and *high side*
- Diagnostics function
- Status indication of the channels via LEDs
- PWM status
- Variable period duration and pulse duty ratio

**Structure**

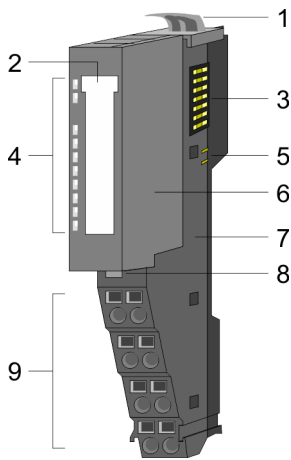

- 1 Locking lever terminal module
- 2 Labeling strip
- 3 Backplane bus
- 4 LED status indication
- 5 DC 24V power section supply
- 6 Electronic module
- 7 Terminal module
- 8 Locking lever electronic module
- 9 Terminal

**Status indication**

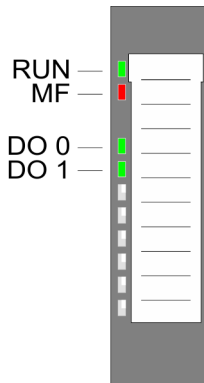

RUN ■ green	MF ■ red	DO x ■ green	Description
■	□	X	Bus communication is OK Module status is OK
■	■	X	Bus communication is OK Module status reports an error with overload, short circuit or overheat
□	■	X	Bus communication is not possible Module status reports an error with overload, short circuit or overheat
□	□	X	Error at bus power supply
X	▣ 2Hz	X	Flashing: Error in configuration <a href="#">↗ Chap. 2.12 'Trouble shooting - LEDs' page 39</a>
■	□	■	PWM output has "1" signal
■	□	□	PWM output has "0" signal
not relevant: X			

**Pin assignment**

For wires with a cross section of 0.08mm<sup>2</sup> up to 1.5mm<sup>2</sup>.

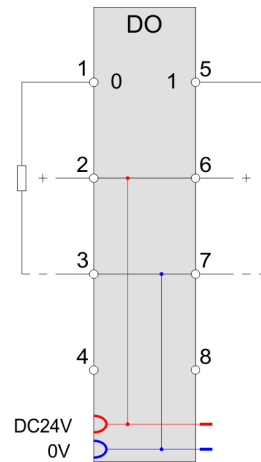
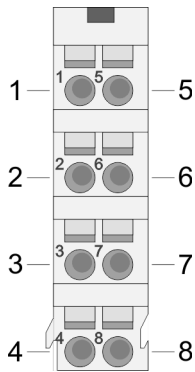

Pos.	Function	Type	Description
1	DO 0	O	PWM output DO 0
2	DC 24V	O	DC 24V
3	0V	O	GND for actuator
4	—	—	not connected
5	DO 1	O	PWM output DO 1
6	DC 24V	O	DC 24V
7	0V	O	GND for actuator
8	—	—	not connected

O: Output



**CAUTION!**  
Feeding in voltage at an output is not allowed and can destroy the module!

**Input area 4byte**

At CPU, PROFIBUS and PROFINET the input respectively output area is embedded to the corresponding address area.

IX - Index for access via CANopen with s = subindex, depends on number of PWM modules

SX - Subindex for access via EtherCAT with Index 6000h + EtherCAT-Slot

More can be found in the according manual of your bus coupler.

Addr.	Name	Bytes	Function	IX	SX
+0	PWMSTS_I	2	PWM 0: Status	5420h/s	01h
+2	PWMSTS_II	2	PWM 1: Status	5420h/s+1	02h



**Status PWM x**

Bit	Name	Function
0	-	reserved
1	STS_PWM	Status PWM 0: PWM output stopped 1: PWM output activated
2	STS_OUTBV	Status output 0: Push/Pull output 1: High side output
3 ... 15	-	reserved

**Output area 12byte**

At CPU, PROFIBUS and PROFINET the output area is embedded to the corresponding address area.

IX - Index for access via CANopen with s = subindex, depends on number of PWM modules

SX - Subindex for access via EtherCAT with Index 7000h + EtherCAT-Slot

More can be found in the according manual of your bus coupler.

Addr.	Name	Bytes	Function	IX	SX
+0	PWMPD_I	4	PWM 0: Pulse duration	5620h/s	01h
+4	PWMPD_II	4	PWM 1: Pulse duration	5620h/s+1	02h
+8	PWMCTRL_I	2	PWM 0: Control word	5621h/s	03h
+10	PWMCTRL_II	2	PWM 1: Control word	5621h/s+1	04h

**PWMPD\_I PWMPD\_II  
Pulse duration**

Here you have to define the pulse duty ratio for the configured *period duration*, by presetting the high level for the corresponding PWM channel. The pulse duration is to be preset as factor to the base 20.83ns.

Range of values: 48 ... 8388607 (1µs ... ca. 175ms)

**PWMCTRL\_I PWMCTRL\_II  
Control word**

Here for the corresponding channel the PWM output behavior may be preset and the PWM output may be started respectively stopped.

Bit	Name	Function
0 ... 1	-	reserved
2	CTRL_OUTBV	PWM output behavior 0: Push/Pull output 1: High side output  With <i>Push/Pull</i> operation it is active switched to high and low level.  With <i>High side</i> operation it is only active switched to high level.
3 ... 7	-	reserved

Bit	Name	Function
8	CTRL_STRT	Edge 0-1 starts PWM output at channel x
9	CTRL_STP	Edge 0-1 stops PWM output at channel x
10 ... 15	-	reserved

#### 4.4.1 Technical data

Order no.	022-1BB90
Type	SM 022
Module ID	0901 4880
<b>Current consumption/power loss</b>	
Current consumption from backplane bus	105 mA
Power loss	0.95 W
<b>Technical data digital outputs</b>	
Number of outputs	2
Cable length, shielded	1000 m
Cable length, unshielded	600 m
Rated load voltage	DC 20.4...28.8 V
Current consumption from load voltage L+ (without load)	15 mA
Total current per group, horizontal configuration, 40°C	1 A
Total current per group, horizontal configuration, 60°C	1 A
Total current per group, vertical configuration	1 A
Output current at signal "1", rated value	0.5 A
Signal logic output	Sourcing output
Output delay of "0" to "1"	max. 100 ns
Output delay of "1" to "0"	max. 100 ns
Minimum load current	-
Lamp load	10 W
Parallel switching of outputs for redundant control of a load	not possible
Parallel switching of outputs for increased power	not possible
Actuation of digital input	✓
Switching frequency with resistive load	max. 40 kHz
Switching frequency with inductive load	max. 40 kHz
Switching frequency on lamp load	max. 40 kHz
Internal limitation of inductive shut-off voltage	L+ (-52 V)
Short-circuit protection of output	yes, electronic, and only highside
Trigger level	2.5 A

<b>Order no.</b>	<b>022-1BB90</b>
Number of operating cycle of relay outputs	-
Switching capacity of contacts	-
Output data size	12 Byte
<b>Status information, alarms, diagnostics</b>	
Status display	green LED per channel
Interrupts	no
Process alarm	no
Diagnostic interrupt	no
Diagnostic functions	no
Diagnostics information read-out	possible
Supply voltage display	green LED
Group error display	red LED
Channel error display	none
<b>Isolation</b>	
Between channels	-
Between channels of groups to	-
Between channels and backplane bus	✓
Insulation tested with	DC 500 V
<b>PWM data</b>	
PWM channels	2
PWM time basis	20.83ns
Period length	1200...8388607 * time base
Minimum pulse width	1 µs
Type of output	Push pull / highside
<b>Safety</b>	
Safety protocol	-
Safety requirements	-
Secure user address	-
Watchdog	-
Two channels	-
Test pulse length	-
Circuit monitoring	-
<b>Datasizes</b>	
Input bytes	4
Output bytes	12
Parameter bytes	12

<b>Order no.</b>	<b>022-1BB90</b>
Diagnostic bytes	20
<b>Housing</b>	
Material	PPE / PPE GF10
Mounting	Profile rail 35 mm
<b>Mechanical data</b>	
Dimensions (WxHxD)	12.9 mm x 109 mm x 76.5 mm
Net weight	61 g
Weight including accessories	61 g
Gross weight	75 g
<b>Environmental conditions</b>	
Operating temperature	0 °C to 60 °C
Storage temperature	-25 °C to 70 °C
<b>Certifications</b>	
UL certification	yes
KC certification	yes

#### 4.4.2 Parameter data

DS - Record set for access via CPU, PROFIBUS and PROFINET

IX - Index for access via CANopen

SX - Subindex for access via EtherCAT with Index 3100h + EtherCAT-Slot

More can be found in the according manual of your bus coupler.

Name	Bytes	Function	Default	DS	IX	SX
PWMPD_I	4	PWM 0: Period duration (Base time: 20.83ns)	1F40h	80h	3100h ... 3103	01h
PWMPD_II	4	PWM 1: Period duration (Base time: 20.83ns)	1F40h	81h	3104h ... 3107	02h

#### PWMPD\_x Period duration

Byte	Bit 7 ... 0
0 ... 3	<p>PWM x Period duration</p> <p>Here you have to configure the whole time for <i>Pulse duration</i> and Pulse break. The time is to be preset as factor to the base 20.83ns.</p> <p>Values lower than 25µs are ignored. Is the <i>pulse duration</i> value greater than or equal the value of <i>period duration</i> the output is permanently set.</p> <p>Range of values: 1200 ... 8388607 (25µs ... ca. 175ms)</p>

#### Principle of operation

By presetting the *period duration* via parameterization and the *pulse duration* via the output area, the pulse duty ratio for the corresponding PWM output channel may be defined.

By changing the pulse duty ration e.g. a drive system, which is connected via PWM may be controlled by the user program.

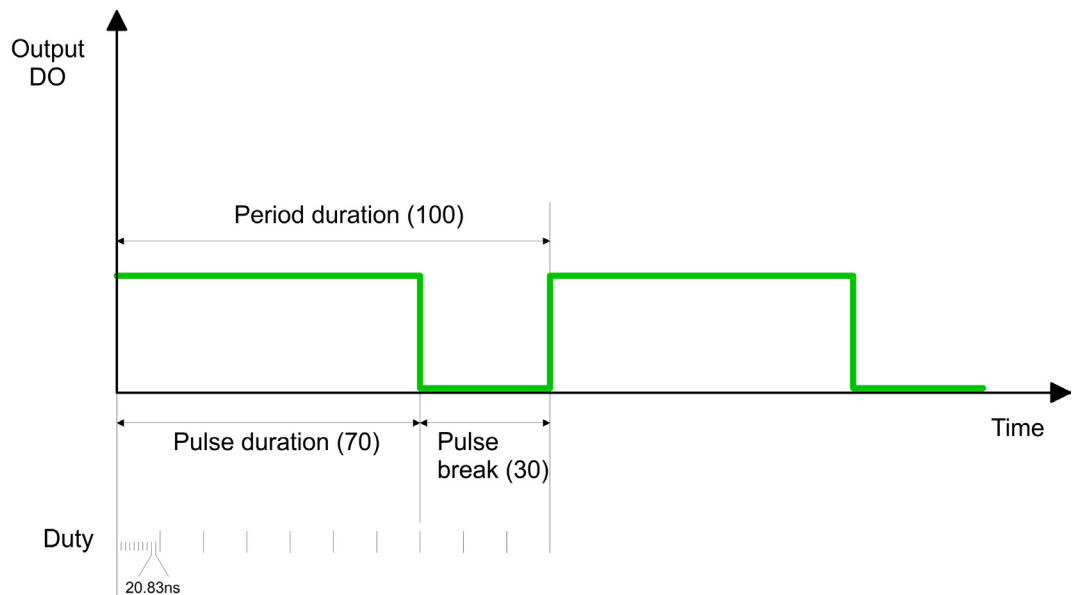

### 4.4.3 Diagnostic data

So this module does not support process interrupts, the diagnostics data serve for information about this module.

DS - Record set for access via CPU, PROFIBUS and PROFINET. The access happens by DS 01h. Additionally the first 4 bytes may be accessed by DS 00h.

IX - Index for access via CANopen. The access happens by IX 2F01h. Additionally the first 4 bytes may be accessed by IX 2F00h.

SX - Subindex for access via EtherCAT with Index 5005h.

More can be found in the according manual of your bus coupler.

Name	Bytes	Function	Default	DS	IX	SX
ERR_A	1	reserved	00h	01h	2F01h	02h
MODTYP	1	Module information	1Fh			03h
ERR_C	1	reserved	00h			04h
ERR_D	1	reserved	00h			05h
CHTYP	1	Channel type	72h			06h
NUMBIT	1	Number of diagnostics bits per channel	00h			07h
NUMCH	1	Number channels of the module	02h			08h
CHERR	1	reserved	00h			09h
CH0ERR... CH7ERR	8	reserved	00h			0Ah ... 11h
DIAG_US	4	µs ticker (32bit)	00h			13h

#### MODTYP Module information

Byte	Bit 7 ... 0
0	Bit 3 ... 0: Module class 1111b: Digital module Bit 4: Channel information present Bit 7 ... 5: reserved

#### CHTYP Channel type

Byte	Bit 7 ... 0
0	Bit 6 ... 0: Channel type 72h: Digital output Bit 7: reserved

#### NUMBIT Diagnostic bits

Byte	Bit 7 ... 0
0	Number of diagnostics bits of the module per channel (here 00h)

**NUMCH Channels**

Byte	Bit 7 ... 0
0	Number of channels of the module (here 02h)

**DIAG\_US  $\mu$ s ticker**

Byte	Bit 7 ... 0
0 ... 3	Value of the $\mu$ s ticker at the moment of the diagnostic data generation

**ERR\_C/D CHERR,  
CHxERR reserved**

Byte	Bit 7 ... 0
0	reserved

### 4.5 022-1BD00 - DO 4xDC 24V 0.5A

#### Properties

The electronic module accepts binary control signals from the central bus system and transfers them to the process level via outputs. It has 4 channels and their status is monitored via LEDs.

- 4 digital outputs, isolated to the backplane bus
- Status indication of the channels via LEDs

#### Structure

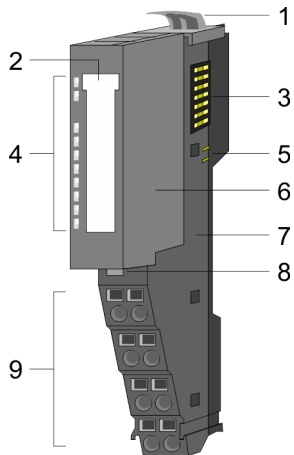

- 1 Locking lever terminal module
- 2 Labeling strip
- 3 Backplane bus
- 4 LED status indication
- 5 DC 24V power section supply
- 6 Electronic module
- 7 Terminal module
- 8 Locking lever electronic module
- 9 Terminal

#### Status indication

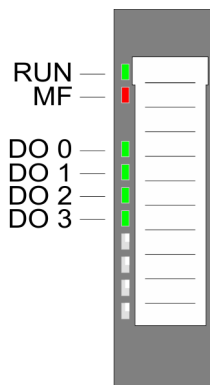

RUN	MF	DO x	Description
<input checked="" type="checkbox"/> green	<input checked="" type="checkbox"/> red	<input checked="" type="checkbox"/> green	
<input checked="" type="checkbox"/>	<input type="checkbox"/>	X	Bus communication is OK Module status is OK
<input checked="" type="checkbox"/>	<input checked="" type="checkbox"/>	X	Bus communication is OK Module status reports an error with overload, short circuit or overheat
<input type="checkbox"/>	<input checked="" type="checkbox"/>	X	Bus communication is not possible Module status reports an error with overload, short circuit or overheat
<input type="checkbox"/>	<input type="checkbox"/>	X	Error at bus power supply
X	<input checked="" type="checkbox"/> 2Hz	X	Flashing: Error in configuration <a href="#">Chap. 2.12 'Trouble shooting - LEDs'</a> page 39
<input checked="" type="checkbox"/>	<input type="checkbox"/>	<input checked="" type="checkbox"/>	Digital output has "1" signal
<input checked="" type="checkbox"/>	<input type="checkbox"/>	<input type="checkbox"/>	Digital output has "0" signal
not relevant: X			



**Pin assignment**

For wires with a cross section of 0.08mm<sup>2</sup> up to 1.5mm<sup>2</sup>.

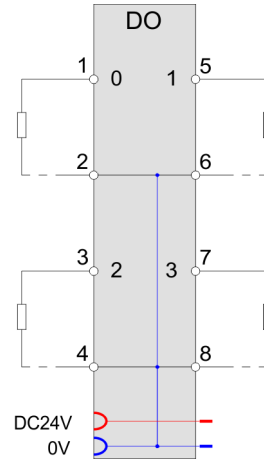
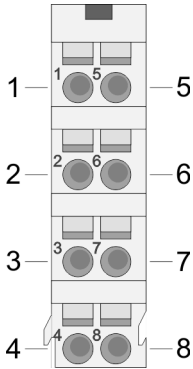

Pos.	Function	Type	Description
1	DO 0	O	Digital output DO 0
2	0V	O	GND for actuator DO 0
3	DO 2	O	Digital output DO 2
4	0V	O	GND for actuator DO 2
5	DO 1	O	Digital output DO 1
6	0V	O	GND for actuator DO 1
7	DO 3	O	Digital output DO 3
8	0V	O	GND for actuator DO 3

O: Output



**CAUTION!**

Feeding in voltage at an output is not allowed and can destroy the module!

**Input area**

No byte of the input area is used by the module.

**Output area**

At CPU, PROFIBUS and PROFINET the output area is embedded to the corresponding address area.

IX - Index for access via CANopen

SX - Subindex for access via EtherCAT with Index 7000h + EtherCAT-Slot

More can be found in the according manual of your bus coupler.

Addr.	Name	Bytes	Function	IX	SX
+0	PIQ	1	State of the outputs	5200h	
			Bit 0: DO 0		01h
			Bit 1: DO 1		02h
			Bit 2: DO 2		03h
			Bit 3: DO 3		04h
			Bit 7 ... 4: reserved		

#### 4.5.1 Technical data

<b>Order no.</b>	<b>022-1BD00</b>
Type	SM 022
Module ID	0104 AFA0
<b>Current consumption/power loss</b>	
Current consumption from backplane bus	75 mA
Power loss	0.5 W
<b>Technical data digital outputs</b>	
Number of outputs	4
Cable length, shielded	1000 m
Cable length, unshielded	600 m
Rated load voltage	DC 20.4...28.8 V
Current consumption from load voltage L+ (without load)	10 mA
Total current per group, horizontal configuration, 40°C	2 A
Total current per group, horizontal configuration, 60°C	2 A
Total current per group, vertical configuration	2 A
Output current at signal "1", rated value	0.5 A
Signal logic output	Sourcing output
Output delay of "0" to "1"	30 µs
Output delay of "1" to "0"	175 µs
Minimum load current	-
Lamp load	10 W
Parallel switching of outputs for redundant control of a load	not possible
Parallel switching of outputs for increased power	not possible
Actuation of digital input	✓
Switching frequency with resistive load	max. 1000 Hz
Switching frequency with inductive load	max. 0.5 Hz
Switching frequency on lamp load	max. 10 Hz

<b>Order no.</b>	<b>022-1BD00</b>
Internal limitation of inductive shut-off voltage	L+ (-45 V)
Short-circuit protection of output	yes, electronic
Trigger level	1 A
Number of operating cycle of relay outputs	-
Switching capacity of contacts	-
Output data size	4 Bit
<b>Status information, alarms, diagnostics</b>	
Status display	green LED per channel
Interrupts	no
Process alarm	no
Diagnostic interrupt	no
Diagnostic functions	no
Diagnostics information read-out	none
Supply voltage display	green LED
Group error display	red LED
Channel error display	none
<b>Isolation</b>	
Between channels	-
Between channels of groups to	-
Between channels and backplane bus	✓
Insulation tested with	DC 500 V
<b>PWM data</b>	
PWM channels	-
PWM time basis	-
Period length	-
Minimum pulse width	-
Type of output	-
<b>Safety</b>	
Safety protocol	-
Safety requirements	-
Secure user address	-
Watchdog	-
Two channels	-
Test pulse length	-
Circuit monitoring	-
<b>Datasizes</b>	

022-1BD00 - DO 4xDC 24V 0.5A &gt; Technical data

<b>Order no.</b>	<b>022-1BD00</b>
Input bytes	0
Output bytes	1
Parameter bytes	0
Diagnostic bytes	0
<b>Housing</b>	
Material	PPE / PPE GF10
Mounting	Profile rail 35 mm
<b>Mechanical data</b>	
Dimensions (WxHxD)	12.9 mm x 109 mm x 76.5 mm
Net weight	57 g
Weight including accessories	57 g
Gross weight	71 g
<b>Environmental conditions</b>	
Operating temperature	0 °C to 60 °C
Storage temperature	-25 °C to 70 °C
<b>Certifications</b>	
UL certification	yes
KC certification	yes

### 4.6 022-1BD20 - DO 4xDC 24V 2A

**Properties**

The electronic module accepts binary control signals from the central bus system and transfers them to the process level via outputs. It has 4 channels and their status is monitored via LEDs.

- 4 digital 2A outputs, isolated to the backplane bus
- Status indication of the channels via LEDs

**Structure**

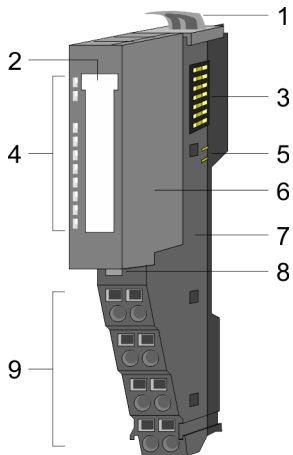

- 1 Locking lever terminal module
- 2 Labeling strip
- 3 Backplane bus
- 4 LED status indication
- 5 DC 24V power section supply
- 6 Electronic module
- 7 Terminal module
- 8 Locking lever electronic module
- 9 Terminal

**Status indication**

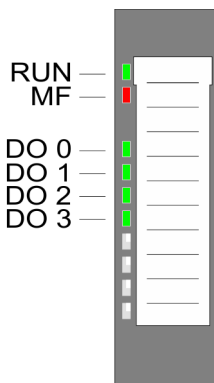

RUN	MF	DO x	Description
<input checked="" type="checkbox"/> green	<input checked="" type="checkbox"/> red	<input checked="" type="checkbox"/> green	
<input checked="" type="checkbox"/>	<input type="checkbox"/>	X	Bus communication is OK Module status is OK
<input checked="" type="checkbox"/>	<input checked="" type="checkbox"/>	X	Bus communication is OK Module status reports an error with overload, short circuit or overheat
<input type="checkbox"/>	<input checked="" type="checkbox"/>	X	Bus communication is not possible Module status reports an error with overload, short circuit or overheat
<input type="checkbox"/>	<input type="checkbox"/>	X	Error at bus power supply
X	<input checked="" type="checkbox"/> 2Hz	X	Flashing: Error in configuration <a href="#">Chap. 2.12 'Trouble shooting - LEDs' page 39</a>
<input checked="" type="checkbox"/>	<input type="checkbox"/>	<input checked="" type="checkbox"/>	Digital output has "1" signal
<input checked="" type="checkbox"/>	<input type="checkbox"/>	<input type="checkbox"/>	Digital output has "0" signal
not relevant: X			

**Pin assignment**

For wires with a cross section of 0.08mm<sup>2</sup> up to 1.5mm<sup>2</sup>.

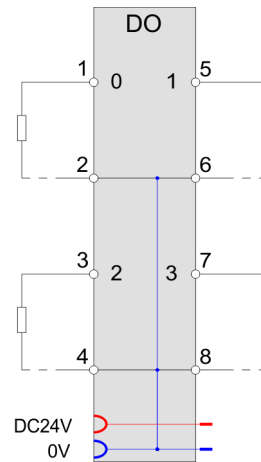
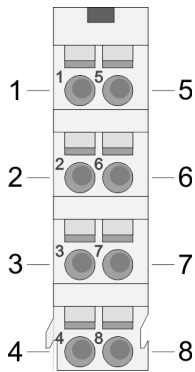

Pos.	Function	Type	Description
1	DO 0	O	Digital output DO 0
2	0V	O	GND for actuator DO 0
3	DO 2	O	Digital output DO 2
4	0V	O	GND for actuator DO 2
5	DO 1	O	Digital output DO 1
6	0V	O	GND for actuator DO 1
7	DO 3	O	Digital output DO 3
8	0V	O	GND for actuator DO 3

O: Output



**CAUTION!**

Feeding in voltage at an output is not allowed and can destroy the module!

**Input area**

No byte of the input area is used by the module.

**Output area**

At CPU, PROFIBUS and PROFINET the output area is embedded to the corresponding address area.

IX - Index for access via CANopen

SX - Subindex for access via EtherCAT with Index 7000h + EtherCAT-Slot

More can be found in the according manual of your bus coupler.

Addr.	Name	Bytes	Function	IX	SX
+0	PIQ	1	State of the outputs	5200h	
			Bit 0: DO 0		01h
			Bit 1: DO 1		02h
			Bit 2: DO 2		03h
			Bit 3: DO 3		04h
			Bit 7 ... 4: reserved		

#### 4.6.1 Technical data

<b>Order no.</b>	<b>022-1BD20</b>
Type	SM 022
Module ID	0108 AFA0
<b>Current consumption/power loss</b>	
Current consumption from backplane bus	75 mA
Power loss	0.8 W
<b>Technical data digital outputs</b>	
Number of outputs	4
Cable length, shielded	1000 m
Cable length, unshielded	600 m
Rated load voltage	DC 20.4...28.8 V
Current consumption from load voltage L+ (without load)	20 mA
Total current per group, horizontal configuration, 40°C	4 A
Total current per group, horizontal configuration, 60°C	4 A
Total current per group, vertical configuration	4 A
Output current at signal "1", rated value	2 A
Signal logic output	Sourcing output
Output delay of "0" to "1"	100 µs
Output delay of "1" to "0"	250 µs
Minimum load current	-
Lamp load	10 W
Parallel switching of outputs for redundant control of a load	not possible
Parallel switching of outputs for increased power	not possible
Actuation of digital input	✓
Switching frequency with resistive load	max. 1000 Hz
Switching frequency with inductive load	max. 0.5 Hz
Switching frequency on lamp load	max. 10 Hz

022-1BD20 - DO 4xDC 24V 2A &gt; Technical data

Order no.	022-1BD20
Internal limitation of inductive shut-off voltage	L+ (-52 V)
Short-circuit protection of output	yes, electronic
Trigger level	2.7 A
Number of operating cycle of relay outputs	-
Switching capacity of contacts	-
Output data size	4 Bit
<b>Status information, alarms, diagnostics</b>	
Status display	green LED per channel
Interrupts	no
Process alarm	no
Diagnostic interrupt	no
Diagnostic functions	no
Diagnostics information read-out	none
Supply voltage display	green LED
Group error display	red LED
Channel error display	none
<b>Isolation</b>	
Between channels	-
Between channels of groups to	-
Between channels and backplane bus	✓
Insulation tested with	DC 500 V
<b>PWM data</b>	
PWM channels	-
PWM time basis	-
Period length	-
Minimum pulse width	-
Type of output	-
<b>Safety</b>	
Safety protocol	-
Safety requirements	-
Secure user address	-
Watchdog	-
Two channels	-
Test pulse length	-
Circuit monitoring	-
<b>Datasizes</b>	



<b>Order no.</b>	<b>022-1BD20</b>
Input bytes	0
Output bytes	1
Parameter bytes	0
Diagnostic bytes	0
<b>Housing</b>	
Material	PPE / PPE GF10
Mounting	Profile rail 35 mm
<b>Mechanical data</b>	
Dimensions (WxHxD)	12.9 mm x 109 mm x 76.5 mm
Net weight	58 g
Weight including accessories	58 g
Gross weight	73 g
<b>Environmental conditions</b>	
Operating temperature	0 °C to 60 °C
Storage temperature	-25 °C to 70 °C
<b>Certifications</b>	
UL certification	yes
KC certification	yes

### 4.7 022-1BD50 - DO 4xDC 24V 0.5A NPN

#### Properties

The electronic module accepts binary control signals from the central bus system and transfers them to the process level via outputs. It has 4 channels connected to the power supply, which operate as low-side switch and their status is monitored via LEDs. Low-side switches are suited to switch grounds. With a short circuit between switch line and ground the load is activated but the power supply is not influenced.

- 4 digital low-side outputs, isolated to the backplane bus
- Status indication of the channels via LEDs

#### Structure

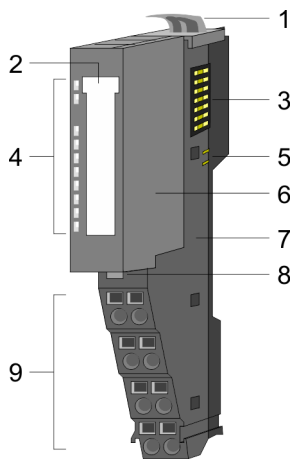

- 1 Locking lever terminal module
- 2 Labeling strip
- 3 Backplane bus
- 4 LED status indication
- 5 DC 24V power section supply
- 6 Electronic module
- 7 Terminal module
- 8 Locking lever electronic module
- 9 Terminal

#### Status indication

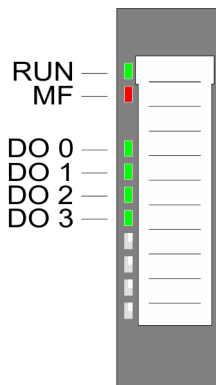

RUN	MF	DO x	Description
<input checked="" type="checkbox"/> green	<input checked="" type="checkbox"/> red	<input checked="" type="checkbox"/> green	
<input checked="" type="checkbox"/>	<input type="checkbox"/>	X	Bus communication is OK Module status is OK
<input checked="" type="checkbox"/>	<input checked="" type="checkbox"/>	X	Bus communication is OK Module status reports an error with overload, short circuit or overheat
<input type="checkbox"/>	<input checked="" type="checkbox"/>	X	Bus communication is not possible Module status reports an error with overload, short circuit or overheat
<input type="checkbox"/>	<input type="checkbox"/>	X	Error at bus power supply
X	<input checked="" type="checkbox"/> 2Hz	X	Flashing: Error in configuration <a href="#">Chap. 2.12 'Trouble shooting - LEDs' page 39</a>
<input checked="" type="checkbox"/>	<input type="checkbox"/>	<input checked="" type="checkbox"/>	Digital output has "1" signal
<input checked="" type="checkbox"/>	<input type="checkbox"/>	<input type="checkbox"/>	Digital output has "0" signal
not relevant: X			

**Pin assignment**

For wires with a cross section of 0.08mm<sup>2</sup> up to 1.5mm<sup>2</sup>.

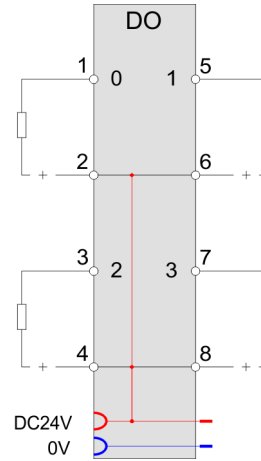
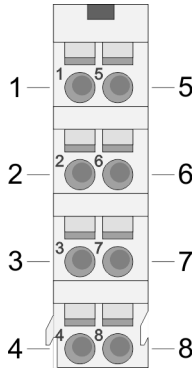

Pos.	Function	Type	Description
1	DO 0	O	Digital output DO 0
2	DC 24V	O	DC 24V for actuator DO 0
3	DO 2	O	Digital output DO 2
4	DC 24V	O	DC 24V for actuator DO 2
5	DO 1	O	Digital output DO 1
6	DC 24V	O	DC 24V for actuator DO 1
7	DO 3	O	Digital output DO 3
8	DC 24V	O	DC 24V for actuator DO 3

O: Output



**CAUTION!**

Feeding in voltage at an output is not allowed and can destroy the module!

**Input area**

No byte of the input area is used by the module.

**Output area**

At CPU, PROFIBUS and PROFINET the output area is embedded to the corresponding address area.

IX - Index for access via CANopen

SX - Subindex for access via EtherCAT with Index 7000h + EtherCAT-Slot

More can be found in the according manual of your bus coupler.

Addr.	Name	Bytes	Function	IX	SX
+0	PIQ	1	State of the outputs	5200h	
			Bit 0: DO 0		01h
			Bit 1: DO 1		02h
			Bit 2: DO 2		03h
			Bit 3: DO 3		04h
			Bit 7 ... 4: reserved		

#### 4.7.1 Technical data

<b>Order no.</b>	<b>022-1BD50</b>
Type	SM 022
Module ID	0105 AFA0
<b>Current consumption/power loss</b>	
Current consumption from backplane bus	75 mA
Power loss	0.5 W
<b>Technical data digital outputs</b>	
Number of outputs	4
Cable length, shielded	1000 m
Cable length, unshielded	600 m
Rated load voltage	DC 20.4...28.8 V
Current consumption from load voltage L+ (without load)	5 mA
Total current per group, horizontal configuration, 40°C	2 A
Total current per group, horizontal configuration, 60°C	2 A
Total current per group, vertical configuration	2 A
Output current at signal "1", rated value	0.5 A
Signal logic output	Sinking output
Output delay of "0" to "1"	30 µs
Output delay of "1" to "0"	100 µs
Minimum load current	-
Lamp load	10 W
Parallel switching of outputs for redundant control of a load	not possible
Parallel switching of outputs for increased power	not possible
Actuation of digital input	✓
Switching frequency with resistive load	max. 1000 Hz
Switching frequency with inductive load	max. 0.5 Hz
Switching frequency on lamp load	max. 10 Hz

<b>Order no.</b>	<b>022-1BD50</b>
Internal limitation of inductive shut-off voltage	+45 V
Short-circuit protection of output	yes, electronic
Trigger level	1.7 A
Number of operating cycle of relay outputs	-
Switching capacity of contacts	-
Output data size	4 Bit
<b>Status information, alarms, diagnostics</b>	
Status display	green LED per channel
Interrupts	no
Process alarm	no
Diagnostic interrupt	no
Diagnostic functions	no
Diagnostics information read-out	none
Supply voltage display	green LED
Group error display	red LED
Channel error display	none
<b>Isolation</b>	
Between channels	-
Between channels of groups to	-
Between channels and backplane bus	✓
Insulation tested with	DC 500 V
<b>PWM data</b>	
PWM channels	-
PWM time basis	-
Period length	-
Minimum pulse width	-
Type of output	-
<b>Safety</b>	
Safety protocol	-
Safety requirements	-
Secure user address	-
Watchdog	-
Two channels	-
Test pulse length	-
Circuit monitoring	-
<b>Datasizes</b>	

022-1BD50 - DO 4xDC 24V 0.5A NPN &gt; Technical data

<b>Order no.</b>	<b>022-1BD50</b>
Input bytes	0
Output bytes	1
Parameter bytes	0
Diagnostic bytes	0
<b>Housing</b>	
Material	PPE / PPE GF10
Mounting	Profile rail 35 mm
<b>Mechanical data</b>	
Dimensions (WxHxD)	12.9 mm x 109 mm x 76.5 mm
Net weight	57 g
Weight including accessories	57 g
Gross weight	72 g
<b>Environmental conditions</b>	
Operating temperature	0 °C to 60 °C
Storage temperature	-25 °C to 70 °C
<b>Certifications</b>	
UL certification	yes
KC certification	yes

### 4.8 022-1BD70 - DO 4xDC 24V 0.5A ETS

#### Properties

The electronic module accepts binary control signals from the central bus system and transfers them time-controlled by means of ETS functionality to the process level via outputs. It has 4 channels and their status is monitored via LEDs. With configured ETS functionality (ETS = edge time stamp) depending on the configuration 5 (20byte) respectively 15 (60byte), you may transfer the states for the outputs together with a time value of the  $\mu$ s ticker as an ETS entry to the FIFO stack. The FIFO memory serves for space for max. 31 ETS entries.

- 4 digital outputs, isolated to the backplane bus
- FIFO stack for 5 respectively 15 ETS entries (each 4byte)
- Diagnostics function
- Controlling by process image respectively handling blocks
- Status indication of the channels via LEDs

#### Structure

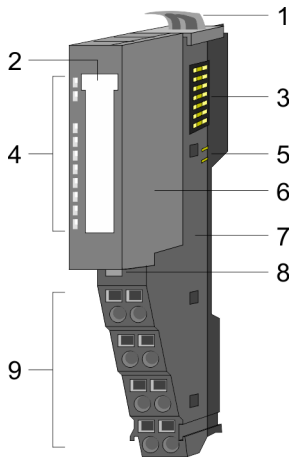

- 1 Locking lever terminal module
- 2 Labeling strip
- 3 Backplane bus
- 4 LED status indication
- 5 DC 24V power section supply
- 6 Electronic module
- 7 Terminal module
- 8 Locking lever electronic module
- 9 Terminal

#### Status indication

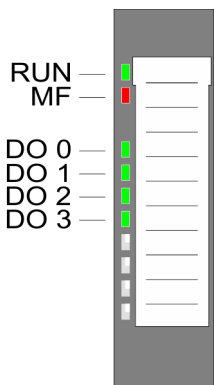

RUN	MF	DO x	Description
<span style="color: green;">■</span> green	<span style="color: red;">■</span> red	<span style="color: green;">■</span> green	
<span style="color: green;">■</span>	<input type="checkbox"/>	X	Bus communication is OK Module status is OK
<span style="color: green;">■</span>	<span style="color: red;">■</span>	X	Bus communication is OK Module status reports an error with overload, short circuit or overheat
<input type="checkbox"/>	<span style="color: red;">■</span>	X	Bus communication is not possible Module status reports an error with overload, short circuit or overheat
<input type="checkbox"/>	<input type="checkbox"/>	X	Error at bus power supply
X	<span style="color: red;">▣</span> 2Hz	X	Flashing: Error in configuration <i>↳ Chap. 2.12 'Trouble shooting - LEDs' page 39</i>
<span style="color: green;">■</span>	<input type="checkbox"/>	<span style="color: green;">■</span>	Digital output has "1" signal
<span style="color: green;">■</span>	<input type="checkbox"/>	<input type="checkbox"/>	Digital output has "0" signal
not relevant: X			

**Pin assignment**

For wires with a cross section of 0.08mm<sup>2</sup> up to 1.5mm<sup>2</sup>.

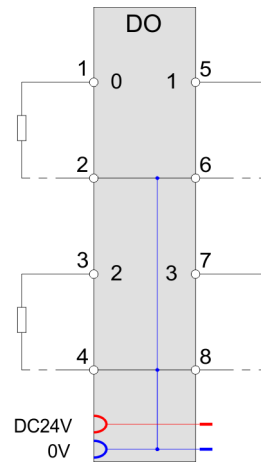
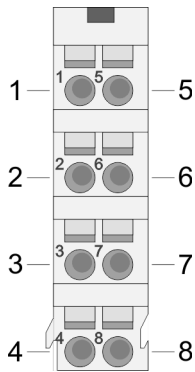

Pos.	Function	Type	Description
1	DO 0	O	Digital output DO 0
2	0V	O	GND for actuator DO 0
3	DO 2	O	Digital output DO 2
4	0V	O	GND for actuator DO 2
5	DO 1	O	Digital output DO 1
6	0V	O	GND for actuator DO 1
7	DO 3	O	Digital output DO 3
8	0V	O	GND for actuator DO 3

O: Output



**CAUTION!**

Feeding in voltage at an output is not allowed and can destroy the module!

**In-/Output area**

With configured ETS functionality (ETS=edge time stamp) a time value (ETS\_US) together with the state of the outputs (PIQ) and a running number (RN) may be stored as ETS entry in the process image.

You may configure the following variants:

- 022-1BD70 DO 4xDC 24V (20): FIFO with 20byte for 5 ETS entries
- 022-1BD70 DO 4xDC 24V (60): FIFO with 60byte for 15 ETS entries



Please consider, with a full FIFO stack no further ETS entries may be accepted.

To ensure that your ETS entries are kept, you should always check the state of the FIFO stack by STS\_FIFO in the input area before.



**Input area 4byte**

The input range is used for status message. At CPU, PROFIBUS and PROFINET the input area is embedded to the corresponding address area.

IX - IX = Index for access via CANopen.

SX - Subindex for access via EtherCAT with Index 6000h + EtherCAT-Slot

More can be found in the according manual of your bus coupler.

Addr.	Name	Bytes	Function	IX	SX
+0	RN_LAST	1	Bit 5 ... 0: RN last FIFO entry Bit 6: 1 (fix) Bit 7: 0 (fix)	5440h	01h
+1	RN_NEXT	1	Bit 5 ... 0: RN next FIFO entry to be processed Bit 6: 1 (fix) Bit 7: 1 (fix)		02h
+2	STS_FIFO	1	State of the FIFO stack		03h
+3	NUM_ETS	1	Number of ETS entries in the FIFO stack		04h

**RN\_LAST**

Bit 5 ... 0: Here the RN of the last ETS entry may be found, which was recognized as valid and written into the FIFO memory of the module.

Bit 6: 1 (fix) - serves for the identification in the process image

Bit 7: 0 (fix) - serves for the identification in the process image

**RN\_NEXT**

Bit 5 ... 0: Here the RN of the ETS entry may be found, which will be executed next in the FIFO memory of the module.

Please consider Bit 6 and 7 of RN\_NEXT are always set.

Bit 6: 1 (fix) - serves for the identification in the process image

Bit 7: 1 (fix) - serves for the identification in the process image

**STS\_FIFO**

The *State* informs about the state of the FIFO stack:

STS_FIFO	Description
00h/80h	Everything is OK. You will get this message directly after the storage in the FIFO memory of the module.
01h/81h	There is no following ETS entry in the FIFO. The RN does not correspond to the expected RN. Please check your RN in the output area.
02h/82h	There are no new ETS entries in the FIFO.
03h/83h	FIFO stack is full. There is no more place for further ETS entries.

If there are less ETS entries written as possible, additionally bit 6 of the last RN must be set. This is necessary; otherwise you have to overwrite the following entries with a "not valid" entry. The module ignores entries after an entry with a set bit 6. If there is an ETS entry in the FIFO memory, whose bit 6 is set, STS\_FIFO is always returned ored with 80h.

**NUM\_ETTS**

Here always the current number of the ETS entries in the FIFO memory of the module may be found.

**Structure of an ETS entry**

Depending on the configuration up to 15 ETS entries may be written via the output area. Each ETS entry uses 4byte in the process image:

**Output area 20byte respectively 60byte**

At CPU, PROFIBUS and PROFINET the output area is embedded to the corresponding address area.

IX - Index for access via CANopen. With s = Subindex the corresponding ETS entry is addressed.

SX - Subindex for access via EtherCAT with Index 7000h + EtherCAT-Slot

More can be found in the according manual of your bus coupler.

Addr.	Name	Bytes	Function	IX	SX
+0	PIQ	1	Output byte	5640h/s	01h
+1	RN	1	Running number		02h
+2	ETS_US	2	µs ticker		03h

**PIQ**

Here the state of the outputs for the corresponding time may be defined and the output channels may be enabled respectively disabled. The output byte has the following bit allocation:

Bit 3 ... 0: 0 (fix)

Bit 4: State DO 3

Bit 5: State DO 2

Bit 6: State DO 1

Bit 7: State DO 0

**RN**

RN (**R**unning **N**umber) is a continuous number 0 ... 63, which has to start with 1. With the RN the chronological order of the ETS entries may be defined. With each ETS entry RN is to be incremented, otherwise the ETS entry may not be recognized by the module.



*If there are less ETS entries written as possible, additionally bit 6 of the last RN must be set. This is necessary; otherwise you have to overwrite the following entries with a "not valid" entry. The module ignores entries after an entry with a set bit 6.*

**ETS\_US**

In the System SLIO module there is a 32 bit timer ( $\mu$ s ticker). With PowerON the timer starts counting. After  $2^{32}-1\mu$ s the timer starts with 0 again. For ETS\_US of an ETS entry you have to define a time value from the low word of the  $\mu$ s ticker (0...65535 $\mu$ s).

Here please enter a time value in  $\mu$ s, to which the state of the outputs is to be taken.

Range of values: 0 ... 65535

**ETS functionality**

The following picture shows how the ETS entries are to be preset in the output area, so that these can be stored in the FIFO memory.

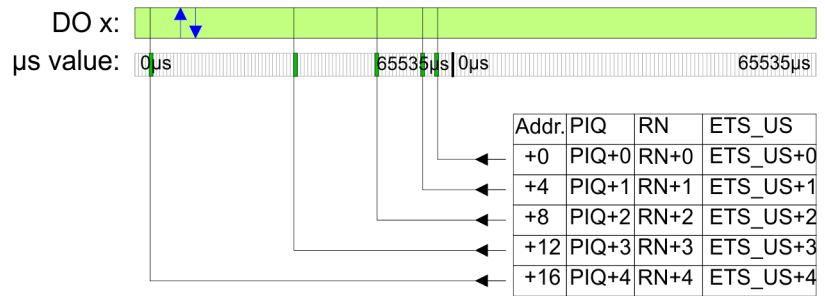

**Output area 20byte respectively 60byte**

At CPU, PROFIBUS and PROFINET the output area is embedded to the corresponding address area.

IX - Index for access via CANopen. With s = Subindex the corresponding ETS entry is addressed.

SX - Subindex for access via EtherCAT with Index 7000h + EtherCAT-Slot

More can be found in the according manual of your bus coupler.

**Configured as 022-1BD70**

DO 4xDC 24V (20)

20byte - 5 ETS entries

Addr.	PIQ	IX=5640h	SX	Addr.	RN	IX=5640h	SX	Addr.	ETS-US	IX=5640h	SX
+0	PIQ+0	s=1	01h	+1	RN+0	s=1	02h	+2	ETS_US+0	s=1	03h
+4	PIQ+1	s=2	04h	+5	RN+1	s=2	05h	+6	ETS_US+1	s=2	06h
+8	PIQ+2	s=3	07h	+9	RN+2	s=3	08h	+10	ETS_US+2	s=3	09h
+12	PIQ+3	s=4	0Ah	+13	RN+3	s=4	0Bh	+14	ETS_US+3	s=4	0Ch
+16	PIQ+4	s=5	0Dh	+17	RN+4	s=5	0Eh	+18	ETS_US+4	s=5	0Fh

022-1BD70 - DO 4xDC 24V 0.5A ETS

**Configured as 022-1BD70** DO 4xDC 24V (60)  
60byte - 15 ETS entries

Addr.	PIQ	IX=5640h	SX	Addr.	RN	IX=5640h	SX	Addr.	ETS-US	IX=5640h	SX
+0	PIQ+0	s=1	01h	+1	RN+0	s=1	02h	+2	ETS_US+0	s=1	03h
+4	PIQ+1	s=2	04h	+5	RN+1	s=2	05h	+6	ETS_US+1	s=2	06h
+8	PIQ+2	s=3	07h	+9	RN+2	s=3	08h	+10	ETS_US+2	s=3	09h
+12	PIQ+3	s=4	0Ah	+13	RN+3	s=4	0Bh	+14	ETS_US+3	s=4	0Ch
+16	PIQ+4	s=5	0Dh	+17	RN+4	s=5	0Eh	+18	ETS_US+4	s=5	0Fh
+20	PIQ+5	s=6	10h	+21	RN+5	s=6	11h	+22	ETS_US+5	s=6	12h
+24	PIQ+6	s=7	13h	+25	RN+6	s=7	14h	+26	ETS_US+6	s=7	15h
+28	PIQ+7	s=8	16h	+29	RN+7	s=8	17h	+30	ETS_US+7	s=8	18h
+32	PIQ+8	s=9	19h	+33	RN+8	s=9	1Ah	+34	ETS_US+8	s=9	1Bh
+36	PIQ+9	s=10	1Ch	+37	RN+9	s=10	1Dh	+38	ETS_US+9	s=10	1Eh
+40	PIQ+10	s=11	1Fh	+41	RN+10	s=11	20h	+42	ETS_US+10	s=11	21h
+44	PIQ+11	s=12	22h	+45	RN+11	s=12	23h	+46	ETS_US+11	s=12	24h
+48	PIQ+12	s=13	25h	+49	RN+12	s=13	26h	+50	ETS_US+12	s=13	27h
+52	PIQ+13	s=14	28h	+53	RN+13	s=14	29h	+54	ETS_US+13	s=14	2Ah
+56	PIQ+14	s=15	2Bh	+57	RN+14	s=15	2Ch	+58	ETS_US+14	s=15	2Dh



*The ETS module may only be accessed by the System System SLIO CPU by means of SFC 15 or via the process image. Only the input data of the ETS module may be read by individual accesses.*

## 4.8.1 Technical data

Order no.	022-1BD70
Type	SM 022 - Digital output
Module ID	0F43 57E2
<b>Current consumption/power loss</b>	
Current consumption from backplane bus	105 mA
Power loss	0.95 W
<b>Technical data digital outputs</b>	
Number of outputs	4
Cable length, shielded	1000 m
Cable length, unshielded	600 m
Rated load voltage	DC 20.4...28.8 V
Current consumption from load voltage L+ (without load)	25 mA
Total current per group, horizontal configuration, 40°C	2 A
Total current per group, horizontal configuration, 60°C	2 A
Total current per group, vertical configuration	2 A
Output current at signal "1", rated value	0.5 A
Signal logic output	Sourcing output
Output delay of "0" to "1"	max. 500 ns
Output delay of "1" to "0"	max. 500 ns
Minimum load current	-
Lamp load	10 W
Parallel switching of outputs for redundant control of a load	not possible
Parallel switching of outputs for increased power	not possible
Actuation of digital input	✓
Switching frequency with resistive load	max. 40 kHz
Switching frequency with inductive load	max. 40 kHz
Switching frequency on lamp load	max. 40 kHz
Internal limitation of inductive shut-off voltage	L+ (-45 V)
Short-circuit protection of output	yes, electronic, and only highside
Trigger level	1 A
Number of operating cycle of relay outputs	-
Switching capacity of contacts	-
Output data size	60 Byte
<b>Status information, alarms, diagnostics</b>	
Status display	green LED per channel
Interrupts	no

022-1BD70 - DO 4xDC 24V 0.5A ETS &gt; Technical data

Order no.	022-1BD70
Process alarm	no
Diagnostic interrupt	no
Diagnostic functions	no
Diagnostics information read-out	possible
Supply voltage display	green LED
Group error display	red LED
Channel error display	none
<b>Isolation</b>	
Between channels	-
Between channels of groups to	-
Between channels and backplane bus	✓
Insulation tested with	DC 500 V
<b>PWM data</b>	
PWM channels	-
PWM time basis	-
Period length	-
Minimum pulse width	-
Type of output	-
<b>Safety</b>	
Safety protocol	-
Safety requirements	-
Secure user address	-
Watchdog	-
Two channels	-
Test pulse length	-
Circuit monitoring	-
<b>Datasizes</b>	
Input bytes	4
Output bytes	20 / 60
Parameter bytes	6
Diagnostic bytes	20
<b>Housing</b>	
Material	PPE / PPE GF10
Mounting	Profile rail 35 mm
<b>Mechanical data</b>	
Dimensions (WxHxD)	12.9 mm x 109 mm x 76.5 mm

<b>Order no.</b>	<b>022-1BD70</b>
Net weight	61 g
Weight including accessories	61 g
Gross weight	76 g
<b>Environmental conditions</b>	
Operating temperature	0 °C to 60 °C
Storage temperature	-25 °C to 70 °C
<b>Certifications</b>	
UL certification	yes
KC certification	yes

## 4.8.2 Parameter data

### 4.8.2.1 Parameters

The module has the following parameter data, which were fix set and may not be altered.

DS - Record set for access via CPU, PROFIBUS and PROFINET

IX - Index for access via CANopen

SX - Subindex for access via EtherCAT with Index 3100h + EtherCAT-Slot

More can be found in the according manual of your bus coupler.

Name	Bytes	Function	Default	DS	IX	SX
PII_L	1	Length process image input data <sup>1</sup>	04h (fix)	02h	3100h	01h
PIQ_L	1	Length process image output data <sup>1, 2</sup>	14h resp. 3Ch (fix)	02h	3101h	02h

1) This record set may only be transferred at STOP state.

2) This parameter depends on the configured variant.

PII_L	Byte	Bit 7 ... 0
	0	The length of the process image of the input data is fix set to 4byte.

PIQ_L	Byte	Bit 7 ... 0
	0	The length of the process image of the output data is fix set to the configured variant (14h or 3Ch).

4.8.2.2 Example for the principle of operation

**ETS values**

In the following it is demonstrated by an example, in which order the ETS entries are stored and processed.

With this example a module is configured, which uses 20byte for 5 ETS entries in the output area PIQ.

With the following times of the  $\mu$ s ticker the following states of the outputs should be taken:

RN	ETS_US in $\mu$ s	PIQ DO 0 (Bit 7)	PIQ DO 1 (Bit 6)	PIQ DO2 (Bit 5)	PIQ DO 3 (Bit 4)
01h	6000	0	0	1	1
02h	12506	1	0	1	1
03h	34518	1	1	1	1
04h	49526	0	0	1	1
05h	54529	0	1	1	1
06h	3500	1	1	1	1
07h	12443	1	0	1	1
08h	20185	0	0	1	1
09h	30140	1	0	1	1
0Ah	37330	0	0	1	1
0Bh	40000	0	0	0	0

**Time diagram**

From the table you get the following time diagram:

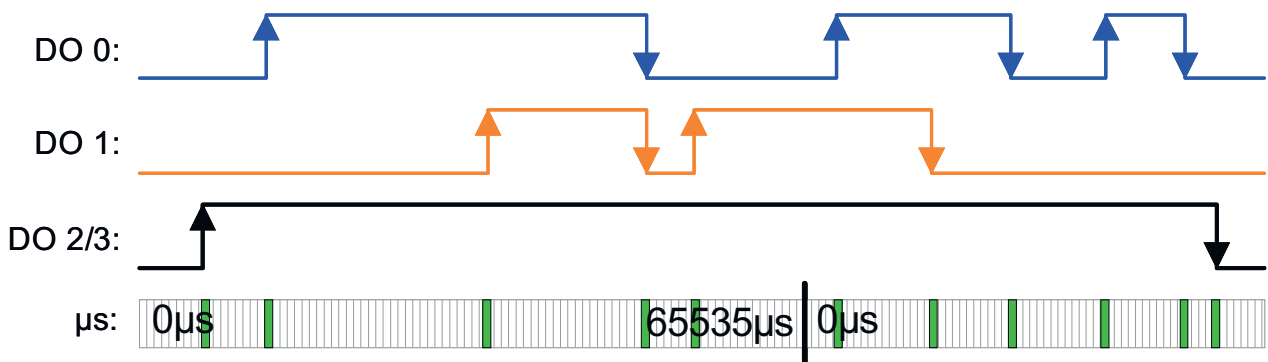



**Writing 5 ETS entries**

After writing the ETS entries into the process output image they are directly stored in the FIFO memory of the module.

The state of the outputs are shown in the diagram at the time "t".

In the PII you will find the status bytes.

Addr.	PIQ	RN	ETS_US	→	FIFO	PIQ	RN	ETS_US	PII
+0	00110000	01h	6000		1	00110000	01h	6000	RN_LAST: 45h
+4	10110000	02h	12506		2	10110000	02h	12506	RN_NEXT: C1h
+8	11110000	03h	34518		3	11110000	03h	34518	STS_FIFO: 00h
+12	00110000	04h	49526		4	00110000	04h	49526	NUM_ETS: 05h
+16	01110000	05h	54529		5	01110000	05h	54529	
					6	00000000	00h	0	
					7	00000000	00h	0	
					8	00000000	00h	0	
					9	00000000	00h	0	
					...	00000000	00h	0	
					31	00000000	00h	0	

**Executing ETS function for RN = 01h**

The 1. ETS entry (RN = 01h) is executed and deleted in the FIFO.

Addr.	PIQ	RN	ETS_US	→	FIFO	PIQ	RN	ETS_US	PII
+0	00110000	01h	6000		1	10110000	02h	12506	RN_LAST: 45h
+4	10110000	02h	12506		2	11110000	03h	34518	RN_NEXT: C2h
+8	11110000	03h	34518		3	00110000	04h	49526	STS_FIFO: 00h/02h
+12	00110000	04h	49526		4	01110000	05h	54529	NUM_ETS: 04h
+16	01110000	05h	54529		5	00000000	00h	0	
					6	00000000	00h	0	
					7	00000000	00h	0	
					8	00000000	00h	0	
					9	00000000	00h	0	
					...	00000000	00h	0	
					31	00000000	00h	0	

**Executing ETS function for RN = 02h ... 04h**

The states of RN = 02h ... RN 04h are successively issued and deleted in the FIFO.

Addr.	PIQ	RN	ETS_US	→	FIFO	PIQ	RN	ETS_US	PII
+0	00110000	01h	6000		1	01110000	05h	54529	RN_LAST: 45h
+4	10110000	02h	12506		2	00000000	00h	0	RN_NEXT: C5h
+8	11110000	03h	34518		3	00000000	00h	0	STS_FIFO: 00h/02h
+12	00110000	04h	49526		4	00000000	00h	0	NUM_ETS: 01h
+16	01110000	05h	54529		5	00000000	00h	0	
					6	00000000	00h	0	
					7	00000000	00h	0	
					8	00000000	00h	0	
					9	00000000	00h	0	
					...	00000000	00h	0	
					31	00000000	00h	0	

**Writing 5 ETS entries**

After writing the next 5 ETS entries into the process output image they are directly stored in the FIFO memory of the module.

Addr.	PIQ	RN	ETS_US	→	FIFO	PIQ	RN	ETS_US	PII
+0	11110000	06h	3500		1	01110000	05h	54529	RN_LAST: 4Ah
+4	10110000	07h	12443		2	11110000	06h	3500	RN_NEXT: C5h
+8	00110000	08h	20185		3	10110000	07h	12443	STS_FIFO: 00h/02h
+12	10110000	09h	30140		4	00110000	08h	20185	NUM_ETS: 06h
+16	00110000	0Ah	37330		5	10110000	09h	30140	
					6	00110000	0Ah	37330	
					7	00000000	00h	0	
					8	00000000	00h	0	
					9	00000000	00h	0	
					...	00000000	00h	0	
					31	00000000	00h	0	

**Executing ETS function for RN = 06h ... 08h**

The states of RN = 06h ... RN 08h are successively issued and deleted in the FIFO.

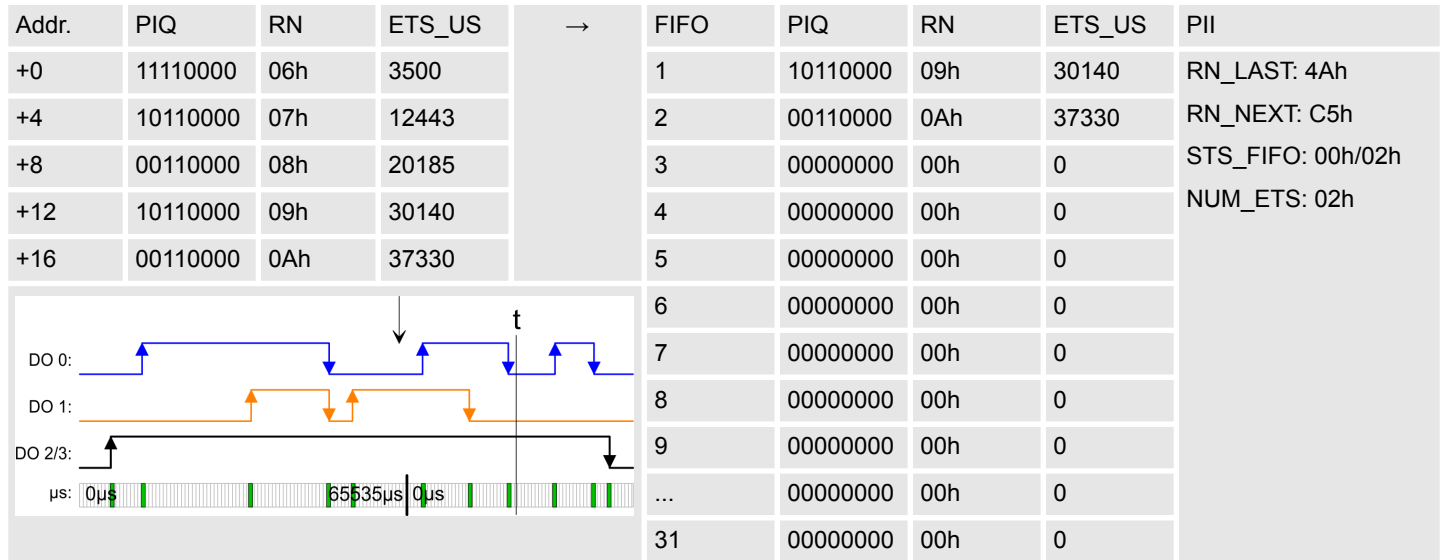

**Writing last ETS entry**

Since less than 5 ETS entries are written, bit 6 of RN of the last ETS entry must always be set. RN = 0Bh becomes 4Bh.

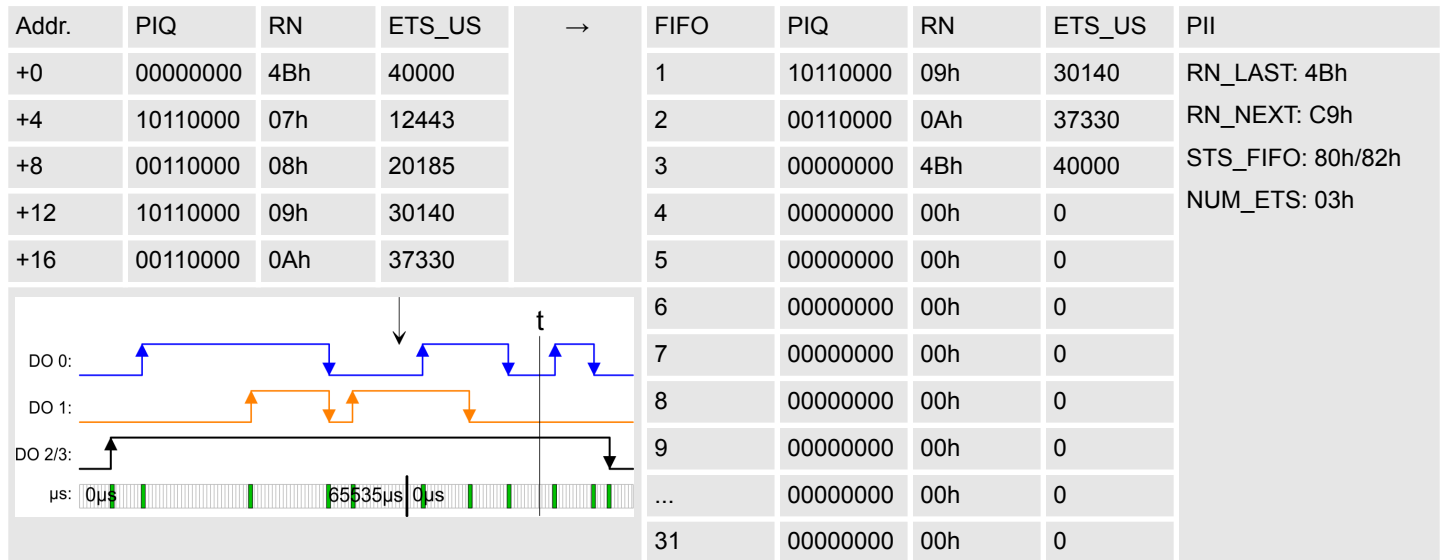

**Executing ETS function for RN = 09h ... 4Bh**

The states of RN = 09h ... RN 4Bh are successively issued and deleted in the FIFO.

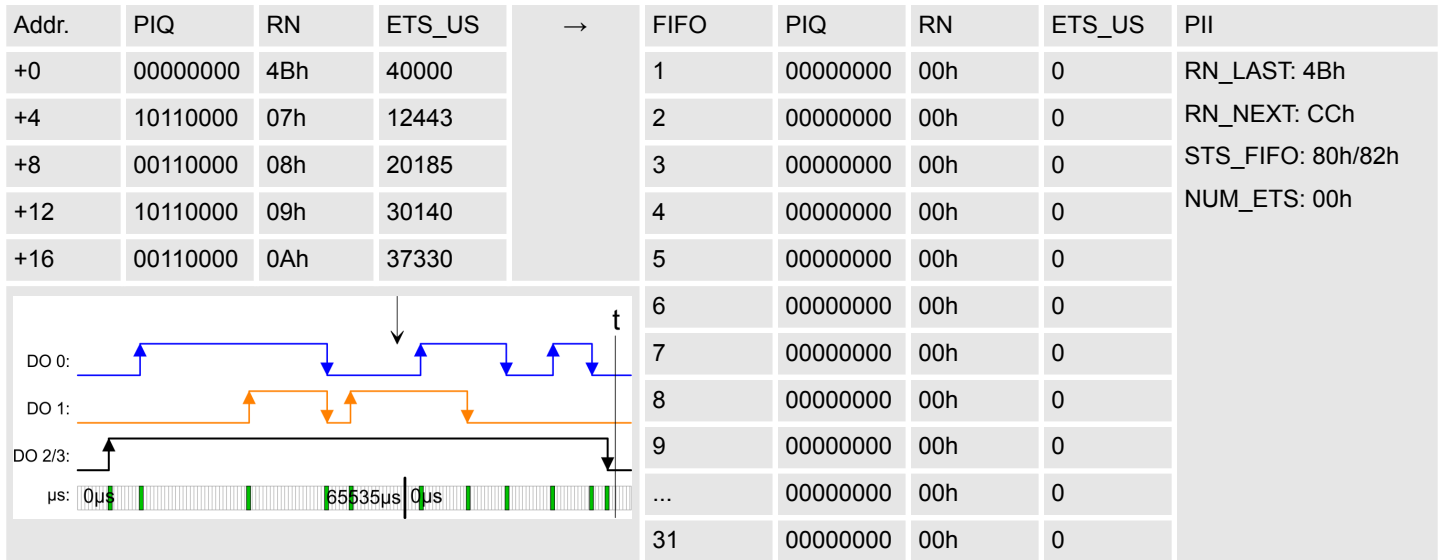

**i** Please consider the ETS modules can only effectively be used together with head modules, which have an integrated  $\mu$ s ticker. The Ethernet coupler with ModbusTCP 053-1MT00 for example does not have an  $\mu$ s ticker.

**4.8.3 Diagnostic data**

This module does not support interrupt functions, the diagnostic data serve the information about this module.

DS - Record set for access via CPU, PROFIBUS and PROFINET. The access happens by DS 01h. Additionally the first 4 bytes may be accessed by DS 00h.

IX - Index for access via CANopen. The access happens by IX 2F01h. Additionally the first 4 bytes may be accessed by IX 2F00h.

SX - Subindex for access via EtherCAT with Index 5005h.

More can be found in the according manual of your bus coupler.

Name	Bytes	Function	Default	DS	IX	SX
ERR_A	1	reserved	00h	01h	2F01h	02h
MODTYP	1	Module information	1Fh			03h
ERR_C	1	reserved	00h			04h
ERR_D	1	reserved	00h			05h
CHTYP	1	Channel type	72h			06h
NUMBIT	1	Number of diagnostics bits per channel	00h			07h
NUMCH	1	Number channels of the module	04h			08h
CHERR	1	reserved	00h			09h
CH0ERR... CH7ERR	8	reserved	00h			0Ah ... 11h
DIAG_US	4	µs ticker (32bit)	00h			13h

**MODTYP Module information**

Byte	Bit 7 ... 0
0	Bit 3 ... 0: Module class 1111b Digital module Bit 4: Channel information present Bit 7 ... 5: reserved

**CHTYP Channel type**

Byte	Bit 7 ... 0
0	Bit 6 ... 0: Channel type 72h: Digital output Bit 7: 0 (fix)

**NUMBIT Diagnostic bits**

Byte	Bit 7 ... 0
0	Number of diagnostics bits of the module per channel (here 00h)

**NUMCH Number of channels**

Byte	Bit 7 ... 0
0	Number of channels of the module (here 04h)

**DIAG\_US µs ticker**

Byte	Bit 7 ... 0
0 ... 3	Value of the µs ticker at the moment of the diagnostic data generation

**ERR\_A/C/D CHERR, CHxERR reserved**

Byte	Bit 7 ... 0
0	reserved

### 4.9 022-1BF00 - DO 8xDC 24V 0.5A

#### Properties

The electronic module accepts binary control signals from the central bus system and transfers them to the process level via outputs. It has 8 channels and their status is monitored via LEDs.

- 8 digital outputs, isolated to the backplane bus
- Status indication of the channels via LEDs

#### Structure

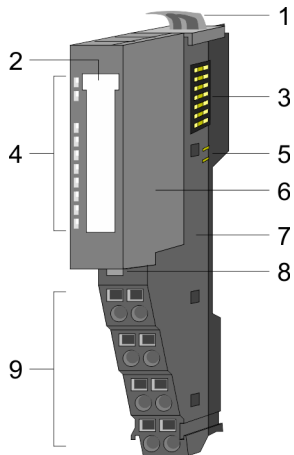

- 1 Locking lever terminal module
- 2 Labeling strip
- 3 Backplane bus
- 4 LED status indication
- 5 DC 24V power section supply
- 6 Electronic module
- 7 Terminal module
- 8 Locking lever electronic module
- 9 Terminal

#### Status indication

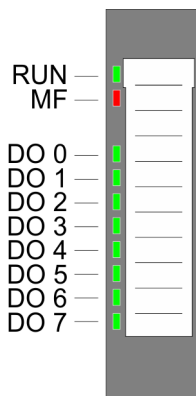

RUN	MF	DO x	Description
<input checked="" type="checkbox"/> green	<input checked="" type="checkbox"/> red	<input checked="" type="checkbox"/> green	
<input checked="" type="checkbox"/>	<input type="checkbox"/>	X	Bus communication is OK Module status is OK
<input checked="" type="checkbox"/>	<input checked="" type="checkbox"/>	X	Bus communication is OK Module status reports an error with overload, short circuit or overheat
<input type="checkbox"/>	<input checked="" type="checkbox"/>	X	Bus communication is not possible Module status reports an error with overload, short circuit or overheat
<input type="checkbox"/>	<input type="checkbox"/>	X	Error at bus power supply
X	<input checked="" type="checkbox"/> 2Hz	X	Flashing: Error in configuration <a href="#">Chap. 2.12 'Trouble shooting - LEDs'</a> page 39
<input checked="" type="checkbox"/>	<input type="checkbox"/>	<input checked="" type="checkbox"/>	Digital output has "1" signal
<input checked="" type="checkbox"/>	<input type="checkbox"/>	<input type="checkbox"/>	Digital output has "0" signal
not relevant: X			

**Pin assignment**

For wires with a cross section of 0.08mm<sup>2</sup> up to 1.5mm<sup>2</sup>.

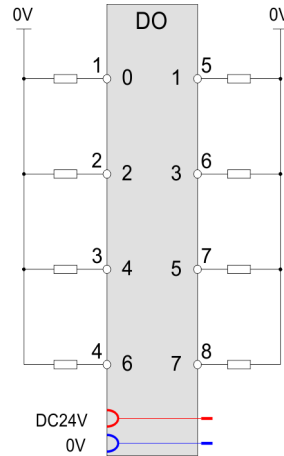
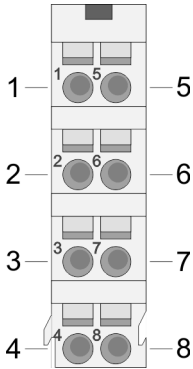

Pos.	Function	Type	Description
1	DO 0	O	Digital output DO 0
2	DO 2	O	Digital output DO 2
3	DO 4	O	Digital output DO 4
4	DO 6	O	Digital output DO 6
5	DO 1	O	Digital output DO 1
6	DO 3	O	Digital output DO 3
7	DO 5	O	Digital output DO 5
8	DO 7	O	Digital output DO 7

O: Output



**CAUTION!**

Feeding in voltage at an output is not allowed and can destroy the module!

**Input area**

No byte of the input area is used by the module.

**Output area**

At CPU, PROFIBUS and PROFINET the output area is embedded to the corresponding address area.

IX - Index for access via CANopen

SX - Subindex for access via EtherCAT with Index 7000h + EtherCAT-Slot

More can be found in the according manual of your bus coupler.

Addr.	Name	Bytes	Function	IX	SX
+0	PIQ	1	State of the outputs	6200h	
			Bit 0: DO 0		01h
			Bit 1: DO 1		02h
			Bit 2: DO 2		03h
			Bit 3: DO 3		04h
			Bit 4: DO 4		05h
			Bit 5: DO 5		06h
			Bit 6: DO 6		07h
			Bit 7: DO 7		08h

#### 4.9.1 Technical data

<b>Order no.</b>	<b>022-1BF00</b>
Type	SM 022
Module ID	0106 AFC8
<b>Current consumption/power loss</b>	
Current consumption from backplane bus	80 mA
Power loss	0.7 W
<b>Technical data digital outputs</b>	
Number of outputs	8
Cable length, shielded	1000 m
Cable length, unshielded	600 m
Rated load voltage	DC 20.4...28.8 V
Current consumption from load voltage L+ (without load)	15 mA
Total current per group, horizontal configuration, 40°C	4 A
Total current per group, horizontal configuration, 60°C	4 A
Total current per group, vertical configuration	4 A
Output current at signal "1", rated value	0.5 A
Signal logic output	Sourcing output
Output delay of "0" to "1"	30 µs
Output delay of "1" to "0"	175 µs
Minimum load current	-
Lamp load	10 W
Parallel switching of outputs for redundant control of a load	not possible
Parallel switching of outputs for increased power	not possible
Actuation of digital input	✓



Order no.	022-1BF00
Switching frequency with resistive load	max. 1000 Hz
Switching frequency with inductive load	max. 0.5 Hz
Switching frequency on lamp load	max. 10 Hz
Internal limitation of inductive shut-off voltage	L+ (-45 V)
Short-circuit protection of output	yes, electronic
Trigger level	1 A
Number of operating cycle of relay outputs	-
Switching capacity of contacts	-
Output data size	8 Bit
<b>Status information, alarms, diagnostics</b>	
Status display	green LED per channel
Interrupts	no
Process alarm	no
Diagnostic interrupt	no
Diagnostic functions	no
Diagnostics information read-out	none
Supply voltage display	green LED
Group error display	red LED
Channel error display	none
<b>Isolation</b>	
Between channels	-
Between channels of groups to	-
Between channels and backplane bus	✓
Insulation tested with	DC 500 V
<b>PWM data</b>	
PWM channels	-
PWM time basis	-
Period length	-
Minimum pulse width	-
Type of output	-
<b>Safety</b>	
Safety protocol	-
Safety requirements	-
Secure user address	-
Watchdog	-
Two channels	-

022-1BF00 - DO 8xDC 24V 0.5A &gt; Technical data

<b>Order no.</b>	<b>022-1BF00</b>
Test pulse length	-
Circuit monitoring	-
<b>Datasizes</b>	
Input bytes	0
Output bytes	1
Parameter bytes	0
Diagnostic bytes	0
<b>Housing</b>	
Material	PPE / PPE GF10
Mounting	Profile rail 35 mm
<b>Mechanical data</b>	
Dimensions (WxHxD)	12.9 mm x 109 mm x 76.5 mm
Net weight	58 g
Weight including accessories	58 g
Gross weight	73 g
<b>Environmental conditions</b>	
Operating temperature	0 °C to 60 °C
Storage temperature	-25 °C to 70 °C
<b>Certifications</b>	
UL certification	yes
KC certification	yes

## 4.10 022-1BF01 - DO 8xDC 24V 0.5A

### Properties

The electronic module collects the binary control signals from the higher-level bus system and transports them to the process level via the outputs. It has 8 channels and their status is monitored via LEDs.

- 8 digital outputs isolated to the backplane bus
- Status indication of the channels via LEDs



*The module is identical to the module with the order no. 022-1BF00 with the following difference:*

- *The module has a new type designation due to the new order number. This requires updating the GSDML and the hardware configuration. You can find the refreshed 'GSDML SLIO' in the 'Download Center' of [www.yaskawa.eu.com](http://www.yaskawa.eu.com)*
- *Due to the internal wiring, the module has a different 'Protective behavior of the outputs' and 'Special behavior of the MF-LED'.*



#### **Protective behavior of the outputs**

*In the event of a short circuit or overload at an output, the output current is initially limited. If the short circuit or overload persists, an integrated thermal protection switches off permanently. Please note that the output has an increased leakage current (< 0.3mA) to DC 24V in this switch-off state, so that a voltmeter for this output shows DC 24V. When the overload on the output is eliminated, the output can only be reactivated after the DC 24V power section supply has been switched off/on.*



#### **Special behavior of the MF LED**

*Please note that the MF LED shows the saved error status of an output. The MF LED lights up in the event of overload, short circuit or overtemperature as long as the corresponding output is activated by the PLC. When the overload on the output is eliminated, the output can only be reactivated after the DC 24V power section supply has been switched off/on.*

### Structure

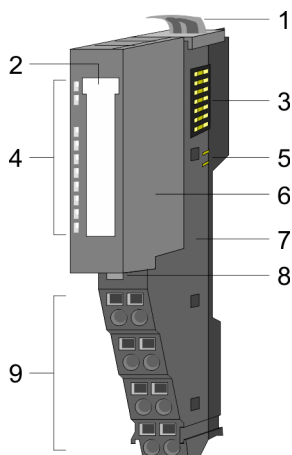

- 1 Locking lever terminal module
- 2 Labeling strip
- 3 Backplane bus
- 4 LED status indication
- 5 DC 24V power section supply
- 6 Electronic module
- 7 Terminal module
- 8 Locking lever electronic module
- 9 Terminal

Status indication

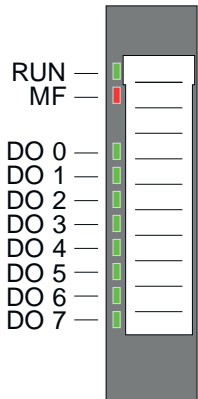

RUN ■ green	MF ■ red	DO x ■ green	Description
■	□	X	Bus communication is OK Module status is OK
■	■	X	Bus communication is OK Module status reports an error with overload, short circuit or overheat
□	■	X	Bus communication is not possible Module status reports an error with overload, short circuit or overheat
□	□	X	Error at bus power supply
X	▣ 2Hz	X	Flashing: Error in configuration <a href="#">🔗 Chap. 2.12 'Trouble shooting - LEDs' page 39</a>
■	□	■	Digital output is controlled with "1" signal
■	□	□	Digital output is controlled with "0" signal
not relevant: X			

**Pin assignment**

For wires with a cross section of 0.08mm<sup>2</sup> up to 1.5mm<sup>2</sup>.

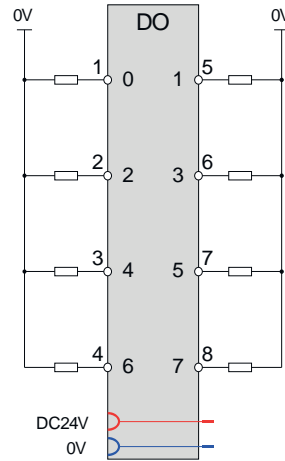
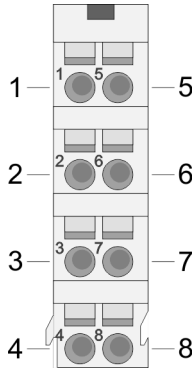

Pos.	Function	Type	Description
1	DO 0	O	Digital output DO 0
2	DO 2	O	Digital output DO 2
3	DO 4	O	Digital output DO 4
4	DO 6	O	Digital output DO 6
5	DO 1	O	Digital output DO 1
6	DO 3	O	Digital output DO 3
7	DO 5	O	Digital output DO 5
8	DO 7	O	Digital output DO 7

O: Output



**CAUTION!**

Feeding in voltage at an output is not allowed and can destroy the module!

**Input area**

No byte of the input area is used by the module.

**Output area**

At CPU, PROFIBUS and PROFINET the output area is embedded to the corresponding address area.

IX - Index for access via CANopen

SX - Subindex for access via EtherCAT with Index 7000h + EtherCAT-Slot

More can be found in the according manual of your bus coupler.

Addr.	Name	Bytes	Function	IX	SX
+0	PIQ	1	State of the outputs	6200h	
			Bit 0: DO 0		01h
			Bit 1: DO 1		02h
			Bit 2: DO 2		03h
			Bit 3: DO 3		04h
			Bit 4: DO 4		05h
			Bit 5: DO 5		06h
			Bit 6: DO 6		07h
			Bit 7: DO 7		08h

#### 4.10.1 Technical data

<b>Order no.</b>	<b>022-1BF01</b>
Type	SM 022
Module ID	0125 AFC8
<b>Current consumption/power loss</b>	
Current consumption from backplane bus	50 mA
Power loss	0.7 W
<b>Technical data digital outputs</b>	
Number of outputs	8
Cable length, shielded	1000 m
Cable length, unshielded	600 m
Rated load voltage	DC 20.4...28.8 V
Current consumption from load voltage L+ (without load)	15 mA
Total current per group, horizontal configuration, 40°C	4 A
Total current per group, horizontal configuration, 60°C	4 A
Total current per group, vertical configuration	4 A
Output current at signal "1", rated value	0.5 A
Signal logic output	Sourcing output
Output delay of "0" to "1"	70 µs
Output delay of "1" to "0"	175 µs
Minimum load current	-
Lamp load	10 W
Parallel switching of outputs for redundant control of a load	not possible
Parallel switching of outputs for increased power	not possible
Actuation of digital input	✓

Order no.	022-1BF01
Switching frequency with resistive load	max. 1000 Hz
Switching frequency with inductive load	max. 0.5 Hz
Switching frequency on lamp load	max. 10 Hz
Internal limitation of inductive shut-off voltage	L+ (-53 V)
Short-circuit protection of output	yes, electronic
Trigger level	1 A
Number of operating cycle of relay outputs	-
Switching capacity of contacts	-
Output data size	8 Bit
<b>Status information, alarms, diagnostics</b>	
Status display	green LED per channel
Interrupts	no
Process alarm	no
Diagnostic interrupt	no
Diagnostic functions	no
Diagnostics information read-out	none
Supply voltage display	green LED
Group error display	red LED
Channel error display	none
<b>Isolation</b>	
Between channels	-
Between channels of groups to	-
Between channels and backplane bus	✓
Insulation tested with	DC 500 V
<b>PWM data</b>	
PWM channels	-
PWM time basis	-
Period length	-
Minimum pulse width	-
Type of output	-
<b>Safety</b>	
Safety protocol	-
Safety requirements	-
Secure user address	-
Watchdog	-
Two channels	-

<b>Order no.</b>	<b>022-1BF01</b>
Test pulse length	-
Circuit monitoring	-
<b>Datasizes</b>	
Input bytes	0
Output bytes	1
Parameter bytes	0
Diagnostic bytes	0
<b>Housing</b>	
Material	PPE / PPE GF10
Mounting	Profile rail 35 mm
<b>Mechanical data</b>	
Dimensions (WxHxD)	12.9 mm x 109 mm x 76.5 mm
Net weight	58 g
Weight including accessories	58 g
Gross weight	73 g
<b>Environmental conditions</b>	
Operating temperature	0 °C to 60 °C
Storage temperature	-25 °C to 70 °C
<b>Certifications</b>	
UL certification	-
KC certification	-



### 4.11 022-1BF50 - DO 8xDC 24V 0.5A NPN

**Properties**

The electronic module accepts binary control signals from the central bus system and transfers them to the process level via outputs. It has 8 channels connected to the power supply, which operate as low-side switch and their status is monitored via LEDs. Low-side switches are suited to switch grounds. With a short circuit between switch line and ground the load is activated but the power supply is not influenced.

- 8 digital low-side outputs, isolated to the backplane bus
- Status indication of the channels via LEDs

**Structure**

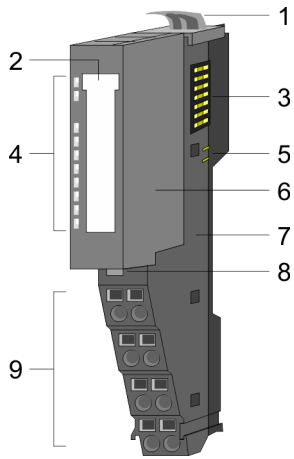

- 1 Locking lever terminal module
- 2 Labeling strip
- 3 Backplane bus
- 4 LED status indication
- 5 DC 24V power section supply
- 6 Electronic module
- 7 Terminal module
- 8 Locking lever electronic module
- 9 Terminal

**Status indication**

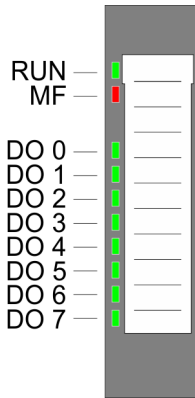

RUN	MF	DO x	Description
<input checked="" type="checkbox"/> green	<input type="checkbox"/> red	<input checked="" type="checkbox"/> green	
<input checked="" type="checkbox"/>	<input type="checkbox"/>	X	Bus communication is OK Module status is OK
<input checked="" type="checkbox"/>	<input checked="" type="checkbox"/>	X	Bus communication is OK Module status reports an error with overload, short circuit or overheat
<input type="checkbox"/>	<input checked="" type="checkbox"/>	X	Bus communication is not possible Module status reports an error with overload, short circuit or overheat
<input type="checkbox"/>	<input type="checkbox"/>	X	Error at bus power supply
X	<input checked="" type="checkbox"/> 2Hz	X	Flashing: Error in configuration <i>Chap. 2.12 'Trouble shooting - LEDs' page 39</i>
<input checked="" type="checkbox"/>	<input type="checkbox"/>	<input checked="" type="checkbox"/>	Digital output has "1" signal
<input checked="" type="checkbox"/>	<input type="checkbox"/>	<input type="checkbox"/>	Digital output has "0" signal
not relevant: X			

**Pin assignment**

For wires with a cross section of 0.08mm<sup>2</sup> up to 1.5mm<sup>2</sup>.

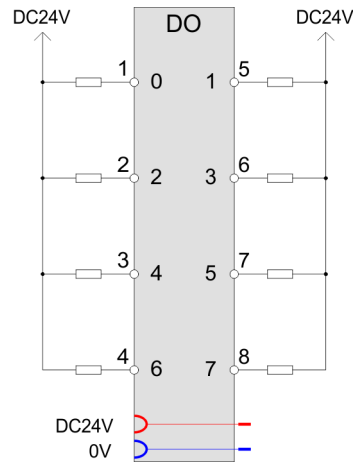
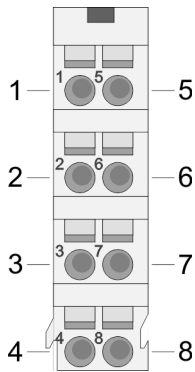

Pos.	Function	Type	Description
1	DO 0	O	Digital output DO 0
2	DO 2	O	Digital output DO 2
3	DO 4	O	Digital output DO 4
4	DO 6	O	Digital output DO 6
5	DO 1	O	Digital output DO 1
6	DO 3	O	Digital output DO 3
7	DO 5	O	Digital output DO 5
8	DO 7	O	Digital output DO 7

O: Output



**CAUTION!**

Feeding in voltage at an output is not allowed and can destroy the module!

**Input area**

No byte of the input area is used by the module.

**Output area**

At CPU, PROFIBUS and PROFINET the output area is embedded to the corresponding address area.

IX - Index for access via CANopen

SX - Subindex for access via EtherCAT with Index 7000h + EtherCAT-Slot

More can be found in the according manual of your bus coupler.

Addr.	Name	Bytes	Function	IX	SX
+0	PIQ	1	State of the outputs	6200h	
			Bit 0: DO 0		01h
			Bit 1: DO 1		02h
			Bit 2: DO 2		03h
			Bit 3: DO 3		04h
			Bit 4: DO 4		05h
			Bit 5: DO 5		06h
			Bit 6: DO 6		07h
			Bit 7: DO 7		08h

#### 4.11.1 Technical data

<b>Order no.</b>	<b>022-1BF50</b>
Type	SM 022
Module ID	0107 AFC8
<b>Current consumption/power loss</b>	
Current consumption from backplane bus	80 mA
Power loss	0.6 W
<b>Technical data digital outputs</b>	
Number of outputs	8
Cable length, shielded	1000 m
Cable length, unshielded	600 m
Rated load voltage	DC 20.4...28.8 V
Current consumption from load voltage L+ (without load)	10 mA
Total current per group, horizontal configuration, 40°C	2.5 A
Total current per group, horizontal configuration, 60°C	2.5 A
Total current per group, vertical configuration	2.5 A
Output current at signal "1", rated value	0.5 A
Signal logic output	Sinking output
Output delay of "0" to "1"	30 µs
Output delay of "1" to "0"	100 µs
Minimum load current	-
Lamp load	10 W
Parallel switching of outputs for redundant control of a load	not possible
Parallel switching of outputs for increased power	not possible
Actuation of digital input	✓

022-1BF50 - DO 8xDC 24V 0.5A NPN &gt; Technical data

Order no.	022-1BF50
Switching frequency with resistive load	max. 1000 Hz
Switching frequency with inductive load	max. 0.5 Hz
Switching frequency on lamp load	max. 10 Hz
Internal limitation of inductive shut-off voltage	+45 V
Short-circuit protection of output	yes, electronic
Trigger level	1.7 A
Number of operating cycle of relay outputs	-
Switching capacity of contacts	-
Output data size	8 Bit
<b>Status information, alarms, diagnostics</b>	
Status display	green LED per channel
Interrupts	no
Process alarm	no
Diagnostic interrupt	no
Diagnostic functions	no
Diagnostics information read-out	none
Supply voltage display	green LED
Group error display	red LED
Channel error display	none
<b>Isolation</b>	
Between channels	-
Between channels of groups to	-
Between channels and backplane bus	✓
Insulation tested with	DC 500 V
<b>PWM data</b>	
PWM channels	-
PWM time basis	-
Period length	-
Minimum pulse width	-
Type of output	-
<b>Safety</b>	
Safety protocol	-
Safety requirements	-
Secure user address	-
Watchdog	-
Two channels	-

<b>Order no.</b>	<b>022-1BF50</b>
Test pulse length	-
Circuit monitoring	-
<b>Datasizes</b>	
Input bytes	0
Output bytes	1
Parameter bytes	0
Diagnostic bytes	0
<b>Housing</b>	
Material	PPE / PPE GF10
Mounting	Profile rail 35 mm
<b>Mechanical data</b>	
Dimensions (WxHxD)	12.9 mm x 109 mm x 76.5 mm
Net weight	58 g
Weight including accessories	58 g
Gross weight	73 g
<b>Environmental conditions</b>	
Operating temperature	0 °C to 60 °C
Storage temperature	-25 °C to 70 °C
<b>Certifications</b>	
UL certification	yes
KC certification	yes

### 4.12 022-1BH00 - DO 16xDC 24V 0.5A

#### Properties

The module detects the binary control signals from the higher-level bus system and transports them to the process level via the outputs. It has 16 channels and their status is indicated by LEDs.

- 16 digital outputs isolated to the backplane bus
- Diagnostic function
- Status indication of the channels via LEDs

#### Structure

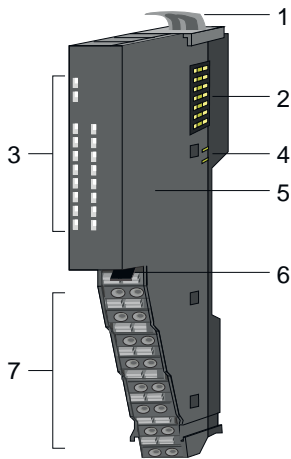

- 1 Locking lever module
- 2 Backplane bus
- 3 LED status indication
- 4 DC 24V power section supply
- 5 Electronic unit
- 6 Locking lever terminal block
- 7 Terminal block

#### Status indication

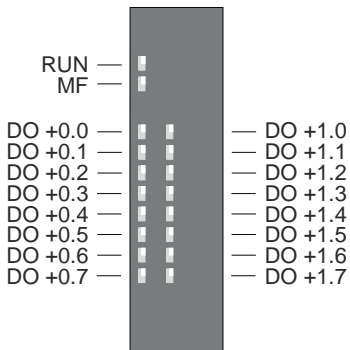

RUN	MF	DO x	Description
<input checked="" type="checkbox"/> green	<input type="checkbox"/> red	<input checked="" type="checkbox"/> green	
<input checked="" type="checkbox"/>	<input type="checkbox"/>	X	Bus communication is OK Module status is OK
<input checked="" type="checkbox"/>	<input checked="" type="checkbox"/>	X	Bus communication is OK Module status reports an error with overload, short circuit or overheat
<input type="checkbox"/>	<input checked="" type="checkbox"/>	X	Bus communication is not possible Module status reports an error with overload, short circuit or overheat
<input type="checkbox"/>	<input type="checkbox"/>	X	Error at bus power supply
X	<input checked="" type="checkbox"/> 2Hz	X	Blinking: Error in configuration <i>Chap. 2.12 'Trouble shooting - LEDs' page 39</i>
<input checked="" type="checkbox"/>	<input type="checkbox"/>	<input checked="" type="checkbox"/>	Digital output is controlled with "1" signal
<input checked="" type="checkbox"/>	<input type="checkbox"/>	<input type="checkbox"/>	Digital output is controlled with "0" signal
not relevant: X			

**Pin assignment**

For wires with a core cross-section of 0.14mm<sup>2</sup> up to 0.75mm<sup>2</sup>. With a core cross-section < 0.25mm<sup>2</sup>, ferrules must be used. ↗ *'Data' page 26*

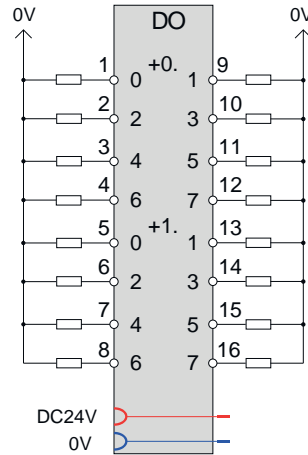
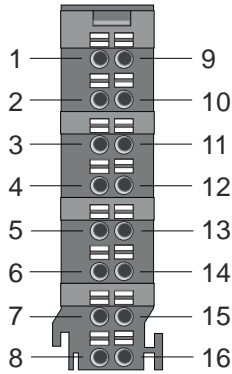

Pos.	Function	Type	Description
1	DO +0.0	O	Digital output DO +0.0
2	DO +0.2	O	Digital output DO +0.2
3	DO +0.4	O	Digital output DO +0.4
4	DO +0.6	O	Digital output DO +0.6
5	DO +1.0	O	Digital output DO +1.0
6	DO +1.2	O	Digital output DO +1.2
7	DO +1.4	O	Digital output DO +1.4
8	DO +1.6	O	Digital output DO +1.6
9	DO +0.1	O	Digital output DO +0.1
10	DO +0.3	O	Digital output DO +0.3
11	DO +0.5	O	Digital output DO +0.5
12	DO +0.7	O	Digital output DO +0.7
13	DO +1.1	O	Digital output DO +1.1
14	DO +1.3	O	Digital output DO +1.3
15	DO +1.5	O	Digital output DO +1.5
16	DO +1.7	O	Digital output DO +1.7

O: Output



**CAUTION!**

Feeding in voltage at an output is not allowed and can destroy the module!

**Input area**

No byte of the input area is used by the module.

**Output area**

At CPU, PROFIBUS and PROFINET the output area is embedded to the corresponding address area.

IX - Index for access via CANopen

SX - Subindex for access via EtherCAT with Index 7000h + EtherCAT-Slot

More can be found in the according manual of your bus coupler.

Addr.	Name	Byte	Function	IX	SX <sup>1</sup>
+0	PIQ	1	Status of the outputs	6200h	
			Bit 0: DO +0.0		01h
			Bit 1: DO +0.1		02h
			Bit 2: DO +0.2		03h
			Bit 3: DO +0.3		04h
			Bit 4: DO +0.4		05h
			Bit 4: DO +0.5		06h
			Bit 4: DO +0.6		07h
			Bit 4: DO +0.7		08h
		1	Status of the outputs	6201h	
			Bit 0: DO +1.0		09h
			Bit 1: DO +1.1		0Ah
			Bit 2: DO +1.2		0Bh
			Bit 3: DO +1.3		0Ch
			Bit 4: DO +1.4		0Dh
			Bit 4: DO +1.5		0Eh
			Bit 4: DO +1.6		0Fh
			Bit 4: DO +1.7		10h

1) Can be displayed as 16 channels with the names DO0 to DO15.

**4.12.1 Technical data**

<b>Order no.</b>	<b>022-1BH00</b>
Type	SM 022
Module ID	0124 2F50
<b>Current consumption/power loss</b>	
Current consumption from backplane bus	35 mA
Power loss	1 W
<b>Technical data digital outputs</b>	
Number of outputs	16
Cable length, shielded	1000 m



Order no.	022-1BH00
Cable length, unshielded	600 m
Rated load voltage	DC 20.4...28.8 V
Current consumption from load voltage L+ (without load)	20 mA
Total current per group, horizontal configuration, 40°C	8 A
Total current per group, horizontal configuration, 60°C	8 A
Total current per group, vertical configuration	8 A
Output current at signal "1", rated value	0.5 A
Signal logic output	Sourcing output
Output delay of "0" to "1"	30 µs
Output delay of "1" to "0"	175 µs
Minimum load current	-
Lamp load	10 W
Parallel switching of outputs for redundant control of a load	not possible
Parallel switching of outputs for increased power	not possible
Actuation of digital input	✓
Switching frequency with resistive load	max. 1000 Hz
Switching frequency with inductive load	max. 0.5 Hz
Switching frequency on lamp load	max. 10 Hz
Internal limitation of inductive shut-off voltage	L+ (-45 V)
Short-circuit protection of output	yes, electronic
Trigger level	1 A
Number of operating cycle of relay outputs	-
Switching capacity of contacts	-
Output data size	4 Bit
<b>Status information, alarms, diagnostics</b>	
Status display	green LED per channel
Interrupts	yes, parameterizable
Process alarm	no
Diagnostic interrupt	yes, parameterizable
Diagnostic functions	yes, parameterizable
Diagnostics information read-out	none
Supply voltage display	green LED
Group error display	red LED
Channel error display	none
<b>Isolation</b>	
Between channels	-

022-1BH00 - DO 16xDC 24V 0.5A &gt; Technical data

<b>Order no.</b>	<b>022-1BH00</b>
Between channels of groups to	-
Between channels and backplane bus	✓
Insulation tested with	DC 500 V
<b>PWM data</b>	
PWM channels	-
PWM time basis	-
Period length	-
Minimum pulse width	-
Type of output	-
<b>Safety</b>	
Safety protocol	-
Safety requirements	-
Secure user address	-
Watchdog	-
Two channels	-
Test pulse length	-
Circuit monitoring	-
<b>Datasizes</b>	
Input bytes	0
Output bytes	2
Parameter bytes	1
Diagnostic bytes	20
<b>Housing</b>	
Material	PPE / PPE GF10
Mounting	Profile rail 35 mm
<b>Mechanical data</b>	
Dimensions (WxHxD)	12.9 mm x 109 mm x 76.5 mm
Net weight	60 g
Weight including accessories	60 g
Gross weight	74 g
<b>Environmental conditions</b>	
Operating temperature	0 °C to 60 °C
Storage temperature	-25 °C to 70 °C
<b>Certifications</b>	
UL certification	yes
KC certification	in preparation

### 4.12.2 Parameter data

DS - Record set for access via CPU, PROFIBUS and PROFINET

IX - Index for access via CANopen

SX - Subindex for access via EtherCAT with Index 3100h + EtherCAT-Slot

More can be found in the according manual of your bus coupler.

Name	Bytes	Function	Default	DS	IX	SX
DIAG_EN	1	Diagnostic interrupt <sup>1</sup>	00h	00h	3100h	01h

1) This record set may only be transferred at STOP state.

#### DIAG\_EN Diagnostic interrupt

Byte	Bit 7 ... 0
0	Diagnostic interrupt 00h: disable 40h: enable

- Here you activate respectively de-activate the diagnostic function.

### 4.12.3 Diagnostic data

Via the parametrization you may activate a diagnostic interrupt for the module. With a diagnostic interrupt the module serves for diagnostic data for diagnostic<sub>incoming</sub>. As soon as the reason for releasing a diagnostic interrupt is no longer present, the diagnostic interrupt<sub>going</sub> automatically takes place.

DS - Record set for access via CPU, PROFIBUS and PROFINET. The access happens by DS 01h. Additionally the first 4 bytes may be accessed by DS 00h.

IX - Index for access via CANopen. The access happens by IX 2F01h. Additionally the first 4 bytes may be accessed by IX 2F00h.

SX - Subindex for access via EtherCAT with Index 5005h.

More can be found in the according manual of your bus coupler.

Name	Bytes	Function	Default	DS	IX	SX
ERR_A	1	Diagnostic	00h	01h	2F01h	02h
MODTYP	1	Module information	1Fh			03h
ERR_C	1	reserved	00h			04h
ERR_D	1	reserved	00h			05h
CHTYP	1	Channel type	72h			06h
NUMBIT	1	reserved	00h			07h
NUMCH	1	reserved	00h			08h
CHERR	1	reserved	00h			09h
CH0ERR	1	reserved	00h			0Ah
CH1ERR	1	reserved	00h			0Bh
...	...	...	...			...
CH7ERR	1	reserved	00h			11h
DIAG_US	4	µs ticker (32bit)	00h			13h

**ERR\_A Diagnostic**

Byte	Bit 7 ... 0
0	Bit 0: set at module failure Bit 1: set at internal error Bit 2: set at external error Bit 3: reserved Bit 4: set at overload at an output Bit 6 ... 5: reserved Bit 7: set at error in parameterization

**MODTYP Module information**

Byte	Bit 7 ... 0
0	Bit 3 ... 0: module class 1111b: Digital module Bit 7 ... 4: reserved

**CHTYP Channel type**

Byte	Bit 7 ... 0
0	Bit 6 ... 0: channel type 72h: Digital output Bit 7: reserved

**DIAG\_US  $\mu$ s ticker**

Byte	Bit 7 ... 0
0...3	Value of the $\mu$ s ticker at the moment of the diagnostic

 *$\mu$ s ticker*

In the System SLIO module there is a timer ( $\mu$ s ticker). With PowerON the timer starts counting with 0. After  $2^{32}-1\mu$ s the timer starts with 0 again.

**ERR\_C/D, NUMBIT,  
NUMCH, CHERR, CHxERR  
reserved**

Byte	Bit 7 ... 0
0	reserved

### 4.13 022-1DF00 - DO 8xDC 24V 0.5A Diagnostic

#### Properties

The electronic module with diagnosis accepts binary control signals from the central bus system and transfers them to the process level via outputs. It has 8 channels and their status is monitored via LEDs.

- 8 digital outputs, isolated to the backplane bus
- Monitoring wire-break and short-circuit
- Diagnostics function
- Status indication of the channels via LEDs

#### Structure

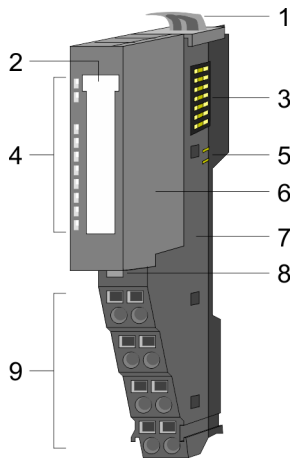

- 1 Locking lever terminal module
- 2 Labeling strip
- 3 Backplane bus
- 4 LED status indication
- 5 DC 24V power section supply
- 6 Electronic module
- 7 Terminal module
- 8 Locking lever electronic module
- 9 Terminal

#### Status indication

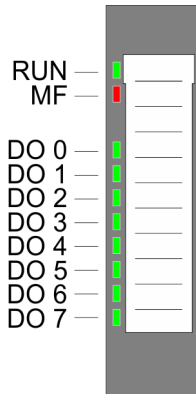

RUN	MF	DO x	Description
<input checked="" type="checkbox"/> green	<input checked="" type="checkbox"/> red	<input checked="" type="checkbox"/> green	
<input checked="" type="checkbox"/>	<input type="checkbox"/>	X	Bus communication is OK Module status is OK
<input checked="" type="checkbox"/>	<input checked="" type="checkbox"/>	X	Bus communication is OK Module status reports an error with wire-break and short-circuit
<input type="checkbox"/>	<input checked="" type="checkbox"/>	X	Bus communication is not possible Module status reports an error with wire-break and short-circuit
<input type="checkbox"/>	<input type="checkbox"/>	X	Error at bus power supply
X	<input checked="" type="checkbox"/> 2Hz	X	Flashing: Error in configuration <a href="#">Chap. 2.12 'Trouble shooting - LEDs' page 39</a>
<input checked="" type="checkbox"/>	<input type="checkbox"/>	<input checked="" type="checkbox"/>	Digital output has "1" signal
<input checked="" type="checkbox"/>	<input type="checkbox"/>	<input type="checkbox"/>	Digital output has "0" signal
not relevant: X			

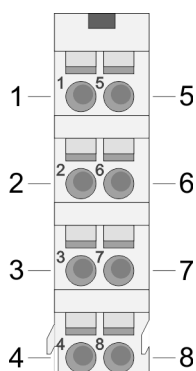
**Pin assignment**

For wires with a cross section of 0.08mm<sup>2</sup> up to 1.5mm<sup>2</sup>.

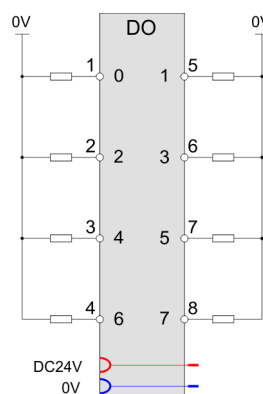

Pos.	Function	Type	Description
1	DO 0	O	Digital output DO 0
2	DO 2	O	Digital output DO 2
3	DO 4	O	Digital output DO 4
4	DO 6	O	Digital output DO 6
5	DO 1	O	Digital output DO 1
6	DO 3	O	Digital output DO 3
7	DO 5	O	Digital output DO 5
8	DO 7	O	Digital output DO 7

O: Output

**CAUTION!**

Feeding in voltage at an output is not allowed and can destroy the module!

**Input area**

No byte of the input area is used by the module.

**Output area**

At CPU, PROFIBUS and PROFINET the output area is embedded to the corresponding address area.

IX - Index for access via CANopen

SX - Subindex for access via EtherCAT with Index 7000h + EtherCAT-Slot

More can be found in the according manual of your bus coupler.

Addr.	Name	Bytes	Function	IX	SX
+0	PIQ	1	State of the outputs	6200h	
			Bit 0: DO 0		01h
			Bit 1: DO 1		02h
			Bit 2: DO 2		03h
			Bit 3: DO 3		04h
			Bit 4: DO 4		05h
			Bit 5: DO 5		06h
			Bit 6: DO 6		07h
			Bit 7: DO 7		08h

#### 4.13.1 Technical data

<b>Order no.</b>	<b>022-1DF00</b>
Type	SM 022
Module ID	0113 2F48
<b>Current consumption/power loss</b>	
Current consumption from backplane bus	70 mA
Power loss	1 W
<b>Technical data digital outputs</b>	
Number of outputs	8
Cable length, shielded	1000 m
Cable length, unshielded	600 m
Rated load voltage	DC 20.4...28.8 V
Current consumption from load voltage L+ (without load)	11 mA
Total current per group, horizontal configuration, 40°C	4 A
Total current per group, horizontal configuration, 60°C	4 A
Total current per group, vertical configuration	4 A
Output current at signal "1", rated value	0.5 A
Signal logic output	Sourcing output
Output delay of "0" to "1"	max. 350 µs
Output delay of "1" to "0"	max. 350 µs
Minimum load current	-
Lamp load	10 W
Parallel switching of outputs for redundant control of a load	not possible
Parallel switching of outputs for increased power	not possible
Actuation of digital input	✓



Order no.	022-1DF00
Switching frequency with resistive load	max. 1000 Hz
Switching frequency with inductive load	max. 0.5 Hz
Switching frequency on lamp load	max. 10 Hz
Internal limitation of inductive shut-off voltage	L+ (-52 V)
Short-circuit protection of output	yes, electronic
Trigger level	1 A
Number of operating cycle of relay outputs	-
Switching capacity of contacts	-
Output data size	8 Bit
<b>Status information, alarms, diagnostics</b>	
Status display	green LED per channel
Interrupts	yes, parameterizable
Process alarm	no
Diagnostic interrupt	yes, parameterizable
Diagnostic functions	yes
Diagnostics information read-out	possible
Supply voltage display	green LED
Group error display	red LED
Channel error display	none
<b>Isolation</b>	
Between channels	-
Between channels of groups to	-
Between channels and backplane bus	✓
Insulation tested with	DC 500 V
<b>PWM data</b>	
PWM channels	-
PWM time basis	-
Period length	-
Minimum pulse width	-
Type of output	-
<b>Safety</b>	
Safety protocol	-
Safety requirements	-
Secure user address	-
Watchdog	-
Two channels	-

<b>Order no.</b>	<b>022-1DF00</b>
Test pulse length	-
Circuit monitoring	-
<b>Datasizes</b>	
Input bytes	0
Output bytes	1
Parameter bytes	7
Diagnostic bytes	20
<b>Housing</b>	
Material	PPE / PPE GF10
Mounting	Profile rail 35 mm
<b>Mechanical data</b>	
Dimensions (WxHxD)	12.9 mm x 109 mm x 76.5 mm
Net weight	57 g
Weight including accessories	57 g
Gross weight	71 g
<b>Environmental conditions</b>	
Operating temperature	0 °C to 60 °C
Storage temperature	-25 °C to 70 °C
<b>Certifications</b>	
UL certification	yes
KC certification	yes

#### 4.13.2 Parameter data

DS - Record set for access via CPU, PROFIBUS and PROFINET

IX - Index for access via CANopen

SX - Subindex for access via EtherCAT with Index 3100h + EtherCAT-Slot

More can be found in the according manual of your bus coupler.

Name	Bytes	Function	Default	DS	IX	SX
DIAG_EN	1	Diagnostics <sup>1</sup>	00h	00h	3100h	01h
WIBRK_EN	1	Wire-break recognition <sup>1</sup>	00h	00h	3101h	02h
CH0D_EN	1	Short-circuit recognition <sup>1</sup>	00h	00h	3102h	03h

1) This record set may only be transferred at STOP state.

**DIAG\_EN Diagnostic interrupt**

Byte	Bit 7 ... 0
0	Diagnostic interrupt 00h: disable 40h: enable

- Here you activate res. de-activate the diagnostic function.

**WIBRK\_EN Wire-break recognition**

Byte	Bit 7 ... 0
0	Bit 0: Wire-break recognition channel 0 (1: on) Bit 1: Wire-break recognition channel 1 (1: on) ... Bit 7: Wire-break recognition channel 7 (1: on)

- Here you activate res. de-activate the Wire-break recognition.

**CH0D\_EN Short-circuit recognition**

Byte	Bit 7 ... 0
0	Bit 0: Short-circuit recognition channel 0 (1: on) Bit 1: Short-circuit recognition channel 1 (1: on) ... Bit 7: Short-circuit recognition channel 7 (1: on)

- Here you activate res. de-activate the Short-circuit recognition.

**4.13.3 Diagnostic data**

The following errors are listed in the diagnostics data:

- Error in project engineering / parameterization
- Wire-break
- Short-circuit
- Error external auxiliary supply

DS - Record set for access via CPU, PROFIBUS and PROFINET. The access happens by DS 01h. Additionally the first 4 bytes may be accessed by DS 00h.

IX - Index for access via CANopen. The access happens by IX 2F01h. Additionally the first 4 bytes may be accessed by IX 2F00h.

SX - Subindex for access via EtherCAT with Index 5005h.

More can be found in the according manual of your bus coupler.

Name	Bytes	Function	Default	DS	IX	SX
ERR_A	1	Diagnostic	00h	01h	2F01h	02h
MODTYP	1	Module information	1Fh			03h
RES2	1	reserved	00h			04h
ERR_D	1	Diagnostic	00h			05h
CHTYP	1	Channel type	72h			06h
NUMBIT	1	Number diagnostic bits per channel	08h			07h
NUMCH	1	Number of channels of a module	08h			08h
CHERR	1	Channel error	00h			09h
CH0ERR	1	Channel-specific error channel 0	00h			0Ah
CH1ERR	1	Channel-specific error channel 1	00h			0Bh
...	...	...	...			...
CH7ERR	1	Channel-specific error channel 7	00h			11h
DIAG_US	4	µs ticker (32bit)	00h			13h

**ERR\_A Diagnostic**

Byte	Bit 7 ... 0
0	Bit 0: set at module failure Bit 1: set at internal error Bit 2: set at external error Bit 3: set at channel error Bit 4: set at external auxiliary supply missing Bit 5, 6: reserved Bit 7: set at error in parameterization

**MODTYP Module information**

Byte	Bit 7 ... 0
0	Bit 3 ... 0: module class 1111b: Digital module Bit 4: set at channel information present Bit 7 ... 5: reserved

**ERR\_D Diagnostic**

Byte	Bit 7 ... 0
0	Bit 3 ... 0: reserved Bit 4: set at internal communication error Bit 7 ... 5: reserved

<b>CHTYP Channel type</b>	<b>Byte</b>	<b>Bit 7 ... 0</b>
	0	

<b>NUMBIT Diagnostic bits</b>	<b>Byte</b>	<b>Bit 7 ... 0</b>
	0	

<b>NUMCH Channels</b>	<b>Byte</b>	<b>Bit 7 ... 0</b>
	0	

<b>CHERR Channel error</b>	<b>Byte</b>	<b>Bit 7 ... 0</b>
	0	

<b>CH0ERR ... CH7ERR Channel specific</b>	<b>Byte</b>	<b>Bit 7 ... 0</b>
	0	

<b>DIAG_US <math>\mu</math>s ticker</b>	<b>Byte</b>	<b>Bit 7 ... 0</b>
	0...3	

 *$\mu$ s ticker*

In the System SLIO module there is a timer ( $\mu$ s ticker). With PowerON the timer starts counting with 0. After  $2^{32}-1\mu$ s the timer starts with 0 again.

### 4.14 022-1HB10 - DO 2xRelay

#### Properties

The electronic module accepts binary control signals from the central bus system and transfers them to the process level via relay outputs. It has 2 channels that operate as switches and the status of each channel is monitored via LEDs.

- 2 relay outputs, isolated to the backplane bus
- DC 30V / AC 230V, 3A
- Status indication of the channels via LEDs

#### Structure

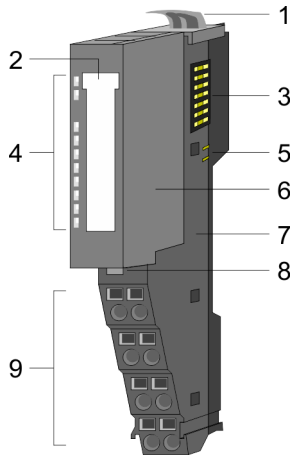

- 1 Locking lever terminal module
- 2 Labeling strip
- 3 Backplane bus
- 4 LED status indication
- 5 DC 24V power section supply
- 6 Electronic module
- 7 Terminal module
- 8 Locking lever electronic module
- 9 Terminal

#### Status indication

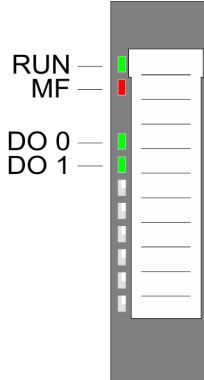

RUN	MF	DO x	Description
<input checked="" type="checkbox"/> green	<input checked="" type="checkbox"/> red	<input checked="" type="checkbox"/> green	
<input checked="" type="checkbox"/>	<input type="checkbox"/>	X	Bus communication is OK Module status is OK
<input checked="" type="checkbox"/>	<input checked="" type="checkbox"/>	X	Bus communication is OK Module status reports an error with overload, short circuit or overheat
<input type="checkbox"/>	<input checked="" type="checkbox"/>	X	Bus communication is not possible Module status reports an error with overload, short circuit or overheat
<input type="checkbox"/>	<input type="checkbox"/>	X	Error at bus power supply
X	<input checked="" type="checkbox"/> 2Hz	X	Flashing: Error in configuration <a href="#">Chap. 2.12 'Trouble shooting - LEDs' page 39</a>
<input checked="" type="checkbox"/>	<input type="checkbox"/>	<input checked="" type="checkbox"/>	Relay output has "1" signal
<input checked="" type="checkbox"/>	<input type="checkbox"/>	<input type="checkbox"/>	Relay output has "0" signal
not relevant: X			



**DANGER!**

The mixed operation of touch and non touch voltages is not permitted!



With HW state 04, an interference suppression capacitor (15nF) has been connected parallel to each relay contact in order to improve the EMC resistance.



**Please note!**

- When using inductive loads, use a suitable protective circuit (see installation guidelines).
- When using loads with a high inrush current, such as electronic ballasts, use a suitable current limiter.

**Pin assignment**

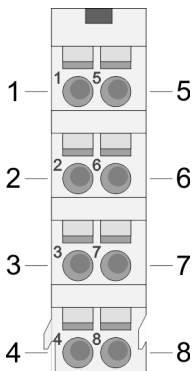

For wires with a cross section of 0.08mm<sup>2</sup> up to 1.5mm<sup>2</sup>.

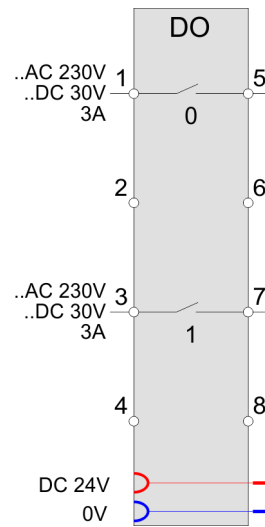

Pos.	Function	Type	Description
1	DO 0	O	Relay output DO 0
2	—	—	not connected
3	DO 1	O	Relay output DO 1
4	—	—	not connected
5	DO 0	O	Relay output DO 0
6	—	—	not connected
7	DO 1	O	Relay output DO 1
8	—	—	not connected

O: Output

Maximum load

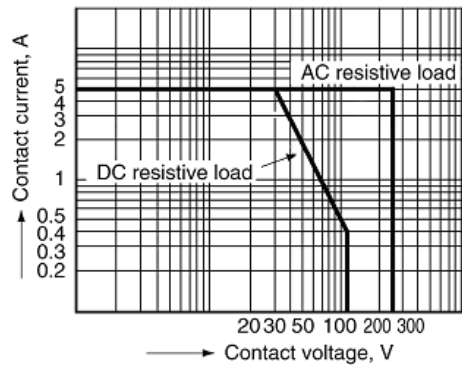

Service life

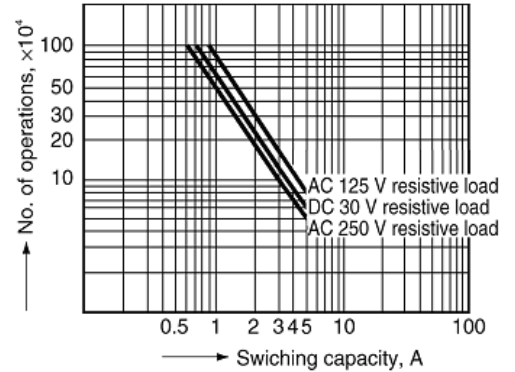

**Input area**

No byte of the input area is used by the module.

**Output area**

At CPU, PROFIBUS and PROFINET the output area is embedded to the corresponding address area.

IX - Index for access via CANopen

SX - Subindex for access via EtherCAT with Index 7000h + EtherCAT-Slot

More can be found in the according manual of your bus coupler.

Addr.	Name	Bytes	Function	IX	SX
+0	PIQ	1	State of the outputs	5200h	
			Bit 0: DO 0		01h
			Bit 1: DO 1		02h
			Bit 7 ... 2: reserved		

**4.14.1 Technical data**

<b>Order no.</b>	<b>022-1HB10</b>
Type	SM 022
Module ID	0109 AF90
<b>Current consumption/power loss</b>	
Current consumption from backplane bus	120 mA
Power loss	0.7 W
<b>Technical data digital outputs</b>	
Number of outputs	2
Cable length, shielded	1000 m
Cable length, unshielded	600 m
Rated load voltage	DC 30 V/ AC 230 V



Order no.	022-1HB10
Current consumption from load voltage L+ (without load)	-
Total current per group, horizontal configuration, 40°C	3 A
Total current per group, horizontal configuration, 60°C	3 A
Total current per group, vertical configuration	3 A
Output current at signal "1", rated value	3 A
Signal logic output	Isolated
Output delay of "0" to "1"	10 ms
Output delay of "1" to "0"	5 ms
Minimum load current	-
Lamp load	-
Parallel switching of outputs for redundant control of a load	not possible
Parallel switching of outputs for increased power	not possible
Actuation of digital input	-
Switching frequency with resistive load	max. 0.33 Hz
Switching frequency with inductive load	max. 0.33 Hz
Switching frequency on lamp load	max. 0.33 Hz
Internal limitation of inductive shut-off voltage	-
Short-circuit protection of output	-
Trigger level	-
Number of operating cycle of relay outputs	-
Switching capacity of contacts	3 A
Output data size	2 Bit
<b>Status information, alarms, diagnostics</b>	
Status display	green LED per channel
Interrupts	no
Process alarm	no
Diagnostic interrupt	no
Diagnostic functions	no
Diagnostics information read-out	none
Supply voltage display	green LED
Group error display	red LED
Channel error display	none
<b>Isolation</b>	
Between channels	✓
Between channels of groups to	-
Between channels and backplane bus	✓

<b>Order no.</b>	<b>022-1HB10</b>
Insulation tested with	AC 2200 V
<b>PWM data</b>	
PWM channels	-
PWM time basis	-
Period length	-
Minimum pulse width	-
Type of output	-
<b>Safety</b>	
Safety protocol	-
Safety requirements	-
Secure user address	-
Watchdog	-
Two channels	-
Test pulse length	-
Circuit monitoring	-
<b>Datasizes</b>	
Input bytes	0
Output bytes	1
Parameter bytes	0
Diagnostic bytes	0
<b>Housing</b>	
Material	PPE / PPE GF10
Mounting	Profile rail 35 mm
<b>Mechanical data</b>	
Dimensions (WxHxD)	12.9 mm x 109 mm x 76.5 mm
Net weight	62 g
Weight including accessories	62 g
Gross weight	76 g
<b>Environmental conditions</b>	
Operating temperature	0 °C to 60 °C
Storage temperature	-25 °C to 70 °C
<b>Certifications</b>	
UL certification	yes
KC certification	yes

### 4.15 022-1HD10 - DO 4xRelay

**Properties**

The electronic module accepts binary control signals from the central bus system and transfers them to the process level via relay outputs. It has 4 channels that operate as switches and the status of each channel is monitored via LEDs.

- 4 relay outputs
  - in groups of two, each with a common terminal
  - isolated between channels and backplane bus
  - isolated between channels of groups
- DC 30V / AC 230V, 1.8 A
- Status indication of the channels via LEDs

**Structure**

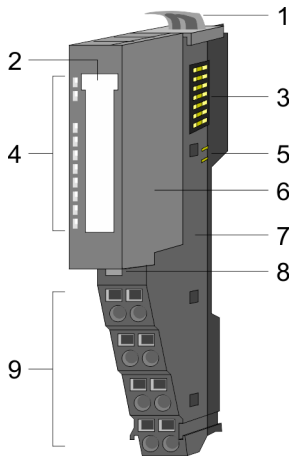

- 1 Locking lever terminal module
- 2 Labeling strip
- 3 Backplane bus
- 4 LED status indication
- 5 DC 24V power section supply
- 6 Electronic module
- 7 Terminal module
- 8 Locking lever electronic module
- 9 Terminal

**Status indication**

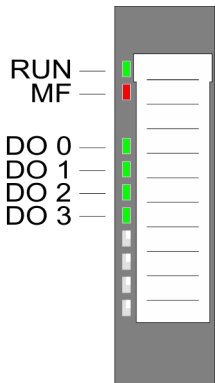

RUN green	MF red	DO x green	Description
■	□	X	Bus communication is OK Module status is OK
■	■	X	Bus communication is OK Module status reports an error with overload, short circuit or overheat
□	■	X	Bus communication is not possible Module status reports an error with overload, short circuit or overheat
□	□	X	Error at bus power supply
X	▣ 2Hz	X	Flashing: Error in configuration <i>↪ Chap. 2.12 'Trouble shooting - LEDs' page 39</i>
■	□	■	Relay output has "1" signal
■	□	□	Relay output has "0" signal
not relevant: X			

Pin assignment

For wires with a cross section of 0.08mm<sup>2</sup> up to 1.5mm<sup>2</sup>.

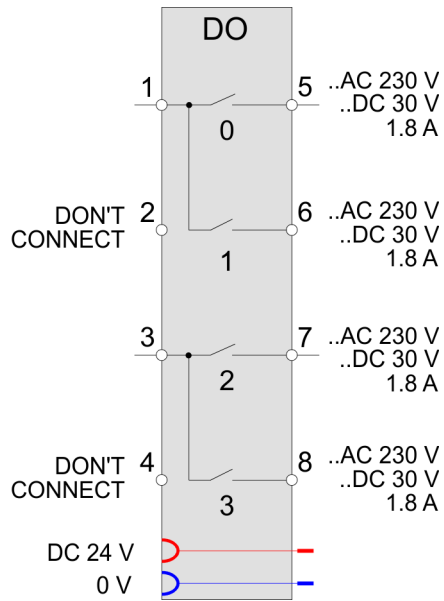
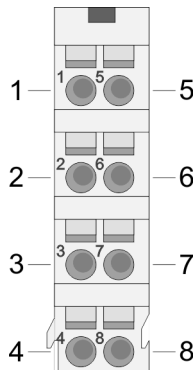

Pos.	Function	Type	Description
1	DO 0/1	O	Relay output DO 0 and DO 1
2	—	—	must not be connected
3	DO 2/3	O	Relay output DO 2 and DO 3
4	—	—	must not be connected
5	DO 0	O	Relay output DO 0
6	DO 1	O	Relay output DO 1
7	DO 2	O	Relay output DO 2
8	DO 3	O	Relay output DO 3

O: Output



**DANGER!**

- Due to the hardware the pins 2 and 4 must not be connected!
- The mixed operation of touch and non touch voltages is not permitted!



With HW state 03, an interference suppression capacitor (15nF) has been connected parallel to each relay contact in order to improve the EMC resistance.



**Please note!**

- When using inductive loads, use a suitable protective circuit (see installation guidelines).
- When using loads with a high inrush current, such as electronic ballasts, use a suitable current limiter.

Maximum load / Service life (typical)

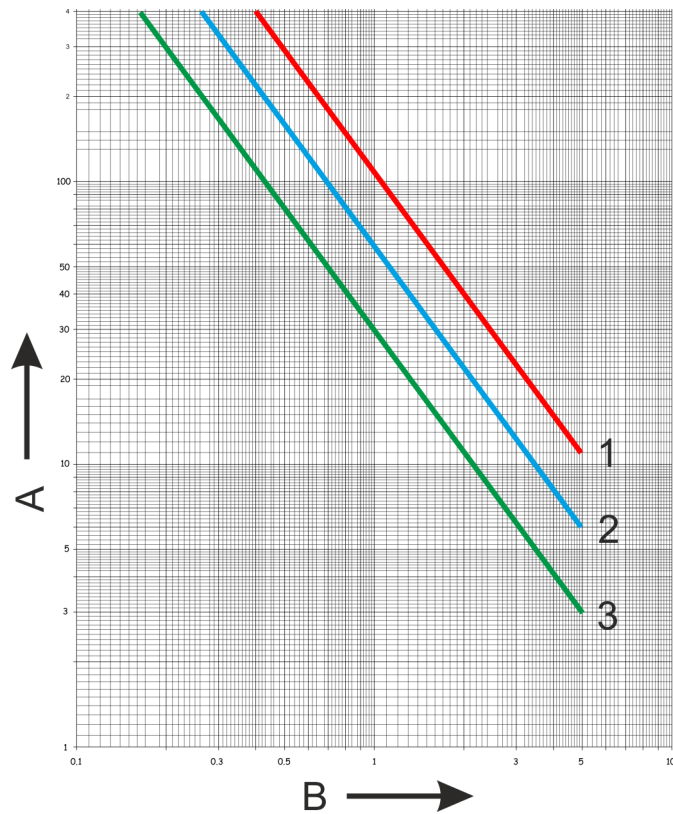

- A Operating cycles (x 10<sup>4</sup>)
- B Current in A
- 1 DC 30V resistive load
- 2 AC 250V resistive load, DC 30V L/R = 7ms
- 3 AC 250V cosφ = 0.4

**Input area**

No byte of the input area is used by the module.

**Output area**

At CPU, PROFIBUS and PROFINET the output area is embedded to the corresponding address area.

IX - Index for access via CANopen with s = Subindex, depends on number and type of analog modules

SX - Subindex for access via EtherCAT with Index 7000h + EtherCAT-Slot

More can be found in the according manual of your bus coupler.

Addr.	Name	Bytes	Function	IX	SX
+0	PIQ	1	State of the outputs	5200h	
			Bit 0: DO 0		01h
			Bit 1: DO 1		02h
			Bit 2: DO 2		03h
			Bit 3: DO 3		04h
			Bit 7 ... 4: reserved		

## 4.15.1 Technical data

Order no.	022-1HD10
Type	SM 022
Module ID	010A AFA0
<b>Current consumption/power loss</b>	
Current consumption from backplane bus	120 mA
Power loss	0.7 W
<b>Technical data digital outputs</b>	
Number of outputs	4
Cable length, shielded	1000 m
Cable length, unshielded	600 m
Rated load voltage	DC 30 V/ AC 230 V
Current consumption from load voltage L+ (without load)	-
Total current per group, horizontal configuration, 40°C	3.6 A
Total current per group, horizontal configuration, 60°C	3 A
Total current per group, vertical configuration	3.6 A
Output current at signal "1", rated value	1.8 A
Signal logic output	Isolated
Output delay of "0" to "1"	10 ms
Output delay of "1" to "0"	5 ms
Minimum load current	-
Lamp load	-
Parallel switching of outputs for redundant control of a load	not possible
Parallel switching of outputs for increased power	not possible
Actuation of digital input	-
Switching frequency with resistive load	max. 0.33 Hz
Switching frequency with inductive load	max. 0.33 Hz
Switching frequency on lamp load	max. 0.33 Hz
Internal limitation of inductive shut-off voltage	-
Short-circuit protection of output	-
Trigger level	-
Number of operating cycle of relay outputs	-
Switching capacity of contacts	5 A
Output data size	4 Bit
<b>Status information, alarms, diagnostics</b>	
Status display	green LED per channel
Interrupts	no

Order no.	022-1HD10
Process alarm	no
Diagnostic interrupt	no
Diagnostic functions	no
Diagnostics information read-out	none
Supply voltage display	green LED
Group error display	red LED
Channel error display	none
<b>Isolation</b>	
Between channels	-
Between channels of groups to	2
Between channels and backplane bus	✓
Insulation tested with	AC 2200 V
<b>PWM data</b>	
PWM channels	-
PWM time basis	-
Period length	-
Minimum pulse width	-
Type of output	-
<b>Safety</b>	
Safety protocol	-
Safety requirements	-
Secure user address	-
Watchdog	-
Two channels	-
Test pulse length	-
Circuit monitoring	-
<b>Datasizes</b>	
Input bytes	0
Output bytes	1
Parameter bytes	0
Diagnostic bytes	0
<b>Housing</b>	
Material	PPE / PPE GF10
Mounting	Profile rail 35 mm
<b>Mechanical data</b>	
Dimensions (WxHxD)	12.9 mm x 109 mm x 76.5 mm

022-1HD10 - DO 4xRelay &gt; Technical data

<b>Order no.</b>	<b>022-1HD10</b>
Net weight	69 g
Weight including accessories	69 g
Gross weight	83 g
<b>Environmental conditions</b>	
Operating temperature	0 °C to 60 °C
Storage temperature	-25 °C to 70 °C
<b>Certifications</b>	
UL certification	yes
KC certification	yes