

VIPA System SLIO

SM-AIO || Manual

HB300 | SM-AIO || en | 20-02

Analog signal modules - SM 03x



YASKAWA Europe GmbH
Ohmstraße 4
91074 Herzogenaurach
Tel.: +49 9132 744 0
Fax: +49 9132 744 186
Email: info@yaskawa.eu.com
Internet: www.yaskawa.eu.com

Table of contents

1	General	7
1.1	Copyright © YASKAWA Europe GmbH.....	7
1.2	About this manual.....	8
1.3	Safety information.....	9
2	Basics and mounting	10
2.1	Safety information for users.....	10
2.2	System conception.....	11
2.2.1	Overview.....	11
2.2.2	Components.....	12
2.2.3	Accessories.....	14
2.2.4	Hardware revision.....	15
2.3	Dimensions.....	15
2.4	Mounting periphery modules.....	18
2.5	Wiring periphery modules.....	21
2.6	Wiring power modules.....	23
2.7	Demounting periphery modules.....	27
2.7.1	Easy Maintenance.....	29
2.8	Trouble shooting - LEDs.....	30
2.9	Installation guidelines.....	31
2.10	General data for the System SLIO.....	33
3	Analog Input	35
3.1	General.....	35
3.2	Analog value	36
3.3	Measuring ranges and function numbers.....	36
3.4	031-1BB10 - AI 2x12Bit 0(4)...20mA - ISO.....	46
3.4.1	Technical data.....	48
3.4.2	Parameter data.....	51
3.4.3	Diagnostics and interrupt.....	54
3.5	031-1BB30 - AI 2x12Bit 0...10V.....	58
3.5.1	Technical data.....	60
3.5.2	Parameter data.....	63
3.5.3	Diagnostic data.....	63
3.6	031-1BB40 - AI 2x12Bit 0(4)...20mA.....	67
3.6.1	Technical data.....	69
3.6.2	Parameter data.....	72
3.6.3	Diagnostic data.....	73
3.7	031-1BB60 - AI 2x12Bit 0(4)...20mA - Sensor.....	76
3.7.1	Technical data.....	78
3.7.2	Parameter data.....	81
3.7.3	Diagnostic data.....	82
3.8	031-1BB70 - AI 2x12Bit ±10V.....	85
3.8.1	Technical data.....	87
3.8.2	Parameter data.....	90
3.8.3	Diagnostic data.....	91
3.9	031-1BB90 - AI 2x16Bit TC.....	94
3.9.1	Technical data.....	97
3.9.2	Parameter data.....	101

3.9.3	Diagnostics and interrupt.....	106
3.10	031-1BD30 - AI 4x12Bit 0...10V.....	110
3.10.1	Technical data.....	112
3.10.2	Parameter data.....	115
3.10.3	Diagnostic data.....	115
3.11	031-1BD40 - AI 4x12Bit 0(4)...20mA.....	119
3.11.1	Technical data.....	121
3.11.2	Parameter data.....	124
3.11.3	Diagnostic data.....	125
3.12	031-1BD70 - AI 4x12Bit \pm 10V.....	129
3.12.1	Technical data.....	131
3.12.2	Parameter data.....	134
3.12.3	Diagnostic data.....	135
3.13	031-1BD80 - AI 4x16Bit R/RTD.....	138
3.13.1	Technical data.....	141
3.13.2	Parameter data.....	145
3.13.3	Diagnostics and interrupt.....	151
3.14	031-1BF60 - AI 8x12Bit 0(4)...20mA.....	155
3.14.1	Technical data.....	157
3.14.2	Parameter data.....	160
3.14.3	Diagnostic data.....	162
3.15	031-1BF74 - AI 8x12Bit \pm 10V.....	165
3.15.1	Technical data.....	167
3.15.2	Parameter data.....	170
3.15.3	Diagnostic data.....	172
3.16	031-1CA20 - AI 1x16(24)Bit Strain gauge (DMS).....	175
3.16.1	Connection variants.....	177
3.16.2	In-/Output area.....	179
3.16.3	Technical data.....	182
3.16.4	Functionality.....	185
3.16.5	Parameter data.....	186
3.16.6	Deployment of the filter functions.....	190
3.16.7	Calibration.....	191
3.16.8	Steady state detection.....	191
3.16.9	Diagnostics.....	192
3.17	031-1CB30 - AI 2x16Bit 0...10V.....	195
3.17.1	Technical data.....	197
3.17.2	Parameter data.....	200
3.17.3	Diagnostics and interrupt.....	202
3.18	031-1CB40 - AI 2x16Bit 0(4)...20mA.....	206
3.18.1	Technical data.....	208
3.18.2	Parameter data.....	212
3.18.3	Diagnostics and interrupt.....	214
3.19	031-1CB70 - AI 2x16Bit \pm 10V.....	218
3.19.1	Technical data.....	220
3.19.2	Parameter data.....	223
3.19.3	Diagnostics and interrupt.....	226
3.20	031-1CD30 - AI 4x16Bit 0...10V.....	230
3.20.1	Technical data.....	232
3.20.2	Parameter data.....	235

3.20.3	Diagnostics and interrupt.....	237
3.21	031-1CD35 - AI 4x16Bit 0...10V.....	241
3.21.1	Technical data.....	243
3.21.2	Parameter data.....	246
3.21.3	Diagnostic data.....	247
3.22	031-1CD40 - AI 4x16Bit 0(4)...20mA.....	250
3.22.1	Technical data.....	252
3.22.2	Parameter data.....	256
3.22.3	Diagnostics and interrupt.....	259
3.23	031-1CD45 - AI 4x16Bit 0(4)...20mA.....	263
3.23.1	Technical data.....	265
3.23.2	Parameter data.....	268
3.23.3	Diagnostic data.....	269
3.24	031-1CD70 - AI 4x16Bit \pm 10V.....	272
3.24.1	Technical data.....	274
3.24.2	Parameter data.....	277
3.24.3	Diagnostics and interrupt.....	280
3.25	031-1LB90 - AI 2x16Bit TC.....	284
3.25.1	Technical data.....	286
3.25.2	Parameter data.....	290
3.25.3	Diagnostic data.....	293
3.26	031-1LD80 - AI 4x16Bit R/RTD.....	296
3.26.1	Technical data.....	298
3.26.2	Parameter data.....	302
3.26.3	Diagnostic data.....	306
3.27	031-1PAxx - AI1x 3Ph 230/400V.....	310
3.27.1	Technical data.....	313
3.27.2	Safety precautions.....	318
3.27.3	Basics.....	321
3.27.4	Connection.....	324
3.27.5	Parameter data.....	326
3.27.6	Measurands.....	331
3.27.7	Process data communication.....	340
3.27.8	Error messages and diagnostics.....	353
3.27.9	VIPA handling block.....	356
4	Analog Output.....	357
4.1	General.....	357
4.2	Analog value.....	357
4.3	Output ranges and function numbers.....	358
4.4	032-1BB30 - AO 2x12Bit 0...10V.....	361
4.4.1	Technical data.....	363
4.4.2	Parameter data.....	365
4.4.3	Diagnostic data.....	366
4.5	032-1BB40 - AO 2x12Bit 0(4)...20mA.....	369
4.5.1	Technical data.....	371
4.5.2	Parameter data.....	373
4.5.3	Diagnostic data.....	375
4.6	032-1BB70 - AO 2x12Bit \pm 10V.....	378
4.6.1	Technical data.....	380

4.6.2	Parameter data.....	382
4.6.3	Diagnostic data.....	384
4.7	032-1BD30 - AO 4x12Bit 0...10V.....	387
4.7.1	Technical data.....	389
4.7.2	Parameter data.....	391
4.7.3	Diagnostic data.....	392
4.8	032-1BD40 - AO 4x12Bit 0(4)...20mA.....	395
4.8.1	Technical data.....	397
4.8.2	Parameter data.....	399
4.8.3	Diagnostic data.....	401
4.9	032-1BD70 - AO 4x12Bit \pm 10V.....	404
4.9.1	Technical data.....	406
4.9.2	Parameter data.....	408
4.9.3	Diagnostic data.....	410
4.10	032-1CB30 - AO 2x16Bit 0...10V.....	413
4.10.1	Technical data.....	415
4.10.2	Parameter data.....	417
4.10.3	Diagnostic data.....	418
4.11	032-1CB40 - AO 2x16Bit 0(4)...20mA.....	421
4.11.1	Technical data.....	423
4.11.2	Parameter data.....	425
4.11.3	Diagnostic data.....	427
4.12	032-1CB70 - AO 2x16Bit \pm 10V.....	430
4.12.1	Technical data.....	432
4.12.2	Parameter data.....	434
4.12.3	Diagnostic data.....	436
4.13	032-1CD30 - AO 4x16Bit 0...10V.....	439
4.13.1	Technical data.....	441
4.13.2	Parameter data.....	443
4.13.3	Diagnostic data.....	444
4.14	032-1CD40 - AO 4x16Bit 0(4)...20mA.....	447
4.14.1	Technical data.....	449
4.14.2	Parameter data.....	451
4.14.3	Diagnostic data.....	453
4.15	032-1CD70 - AO 4x16Bit \pm 10V.....	456
4.15.1	Technical data.....	458
4.15.2	Parameter data.....	460
4.15.3	Diagnostic data.....	462

1 General

1.1 Copyright © YASKAWA Europe GmbH

All Rights Reserved

This document contains proprietary information of YASKAWA and is not to be disclosed or used except in accordance with applicable agreements.

This material is protected by copyright laws. It may not be reproduced, distributed, or altered in any fashion by any entity (either internal or external to YASKAWA) except in accordance with applicable agreements, contracts or licensing, without the express written consent of YASKAWA and the business management owner of the material.

For permission to reproduce or distribute, please contact: YASKAWA Europe GmbH, European Headquarters, Hauptstraße 185, 65760 Eschborn, Germany

Tel.: +49 6196 569 300

Fax.: +49 6196 569 398

Email: info@yaskawa.eu.com

Internet: www.yaskawa.eu.com



Every effort has been made to ensure that the information contained in this document was complete and accurate at the time of publishing. Nevertheless, the authors retain the right to modify the information.

This customer document describes all the hardware units and functions known at the present time. Descriptions may be included for units which are not present at the customer site. The exact scope of delivery is described in the respective purchase contract.

EC conformity declaration

Hereby, YASKAWA Europe GmbH declares that the products and systems are in compliance with the essential requirements and other relevant provisions. Conformity is indicated by the CE marking affixed to the product.

Conformity Information

For more information regarding CE marking and Declaration of Conformity (DoC), please contact your local representative of YASKAWA Europe GmbH.

Trademarks

VIPA, SLIO, System 100V, System 200V, System 300V, System 300S, System 400V, System 500S and Commander Compact are registered trademarks of YASKAWA Europe GmbH.

SPEED7 is a registered trademark of YASKAWA Europe GmbH.

SIMATIC, STEP, SINEC, TIA Portal, S7-300, S7-400 and S7-1500 are registered trademarks of Siemens AG.

Microsoft and Windows are registered trademarks of Microsoft Inc., USA.

Portable Document Format (PDF) and Postscript are registered trademarks of Adobe Systems, Inc.

All other trademarks, logos and service or product marks specified herein are owned by their respective companies.

Document support	<p>Contact your local representative of YASKAWA Europe GmbH if you have errors or questions regarding the content of this document. If such a location is not available, you can reach YASKAWA Europe GmbH via the following contact:</p> <p>YASKAWA Europe GmbH, Ohmstraße 4, 91074 Herzogenaurach, Germany</p> <p>Fax: +49 9132 744 29 1204</p> <p>Email: Documentation.HER@yaskawa.eu.com</p>
Technical support	<p>Contact your local representative of YASKAWA Europe GmbH if you encounter problems or have questions regarding the product. If such a location is not available, you can reach the YASKAWA customer service via the following contact:</p> <p>YASKAWA Europe GmbH, European Headquarters, Hauptstraße 185, 65760 Eschborn, Germany</p> <p>Tel.: +49 6196 569 500 (hotline)</p> <p>Email: support@yaskawa.eu.com</p>

1.2 About this manual

Target audience	The manual is targeted at users who have a background in automation technology.
Structure of the manual	The manual consists of chapters. Every chapter provides a self-contained description of a specific topic.
Guide to the document	<p>The following guides are available in the manual:</p> <ul style="list-style-type: none">■ An overall table of contents at the beginning of the manual■ References with page numbers
Availability	<p>The manual is available in:</p> <ul style="list-style-type: none">■ printed form, on paper■ in electronic form as PDF-file (Adobe Acrobat Reader)
Icons Headings	Important passages in the text are highlighted by following icons and headings:

**DANGER!**

Immediate or likely danger. Personal injury is possible.

**CAUTION!**

Damages to property is likely if these warnings are not heeded.



Supplementary information and useful tips.

1.3 Safety information

Applications conforming with specifications

The system is constructed and produced for:

- communication and process control
- general control and automation tasks
- industrial applications
- operation within the environmental conditions specified in the technical data
- installation into a cubicle



DANGER!

This device is not certified for applications in

- in explosive environments (EX-zone)

Documentation

The manual must be available to all personnel in the

- project design department
- installation department
- commissioning
- operation



CAUTION!

The following conditions must be met before using or commissioning the components described in this manual:

- Hardware modifications to the process control system should only be carried out when the system has been disconnected from power!
- Installation and hardware modifications only by properly trained personnel.
- The national rules and regulations of the respective country must be satisfied (installation, safety, EMC ...)

Disposal

National rules and regulations apply to the disposal of the unit!

2 Basics and mounting

2.1 Safety information for users

Handling of electrostatic sensitive modules

VIPA modules make use of highly integrated components in MOS-Technology. These components are extremely sensitive to over-voltages that can occur during electrostatic discharges. The following symbol is attached to modules that can be destroyed by electrostatic discharges.



The Symbol is located on the module, the module rack or on packing material and it indicates the presence of electrostatic sensitive equipment. It is possible that electrostatic sensitive equipment is destroyed by energies and voltages that are far less than the human threshold of perception. These voltages can occur where persons do not discharge themselves before handling electrostatic sensitive modules and they can damage components thereby, causing the module to become inoperable or unusable. Modules that have been damaged by electrostatic discharges can fail after a temperature change, mechanical shock or changes in the electrical load. Only the consequent implementation of protection devices and meticulous attention to the applicable rules and regulations for handling the respective equipment can prevent failures of electrostatic sensitive modules.

Shipping of modules

Modules must be shipped in the original packing material.

Measurements and alterations on electrostatic sensitive modules

When you are conducting measurements on electrostatic sensitive modules you should take the following precautions:

- Floating instruments must be discharged before use.
- Instruments must be grounded.

Modifying electrostatic sensitive modules you should only use soldering irons with grounded tips.



CAUTION!

Personnel and instruments should be grounded when working on electrostatic sensitive modules.

2.2 System conception

2.2.1 Overview

System SLIO is a modular automation system for assembly on a 35mm mounting rail. By means of the peripheral modules with 2, 4 or 8 channels this system may properly be adapted matching to your automation tasks. The wiring complexity is low, because the supply of the DC 24V power section is integrated to the backplane bus and defective modules may be replaced with standing wiring. By deployment of the power modules in contrasting colors within the system, further isolated areas may be defined for the DC 24V power section supply, respectively the electronic power supply may be extended with 2A.

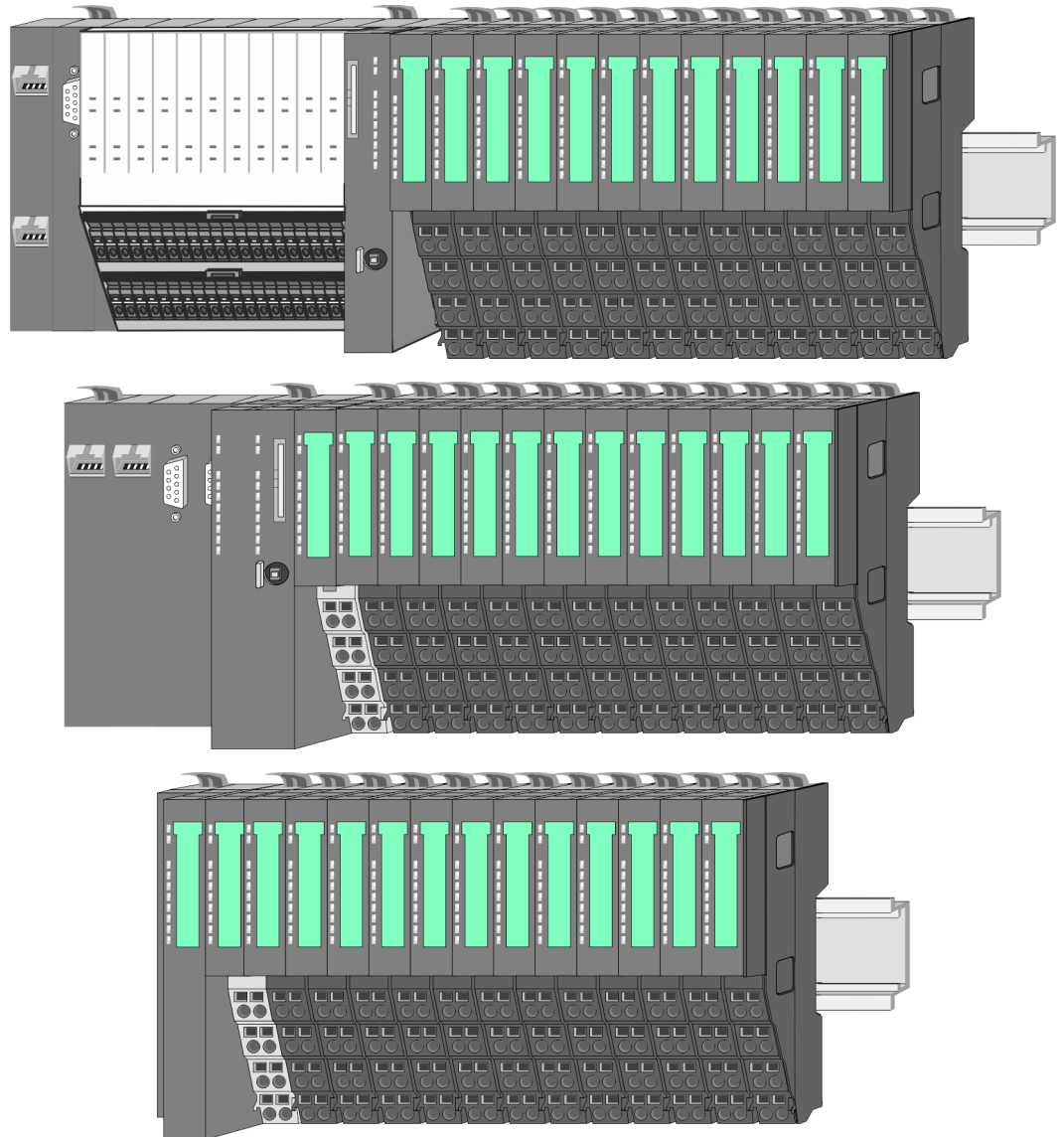

2.2.2 Components

- CPU (head module)
- Bus coupler (head module)
- Line extension
- Periphery modules
- Accessories



CAUTION!

Only VIPA modules may be combined. A mixed operation with third-party modules is not allowed!

CPU 01xC

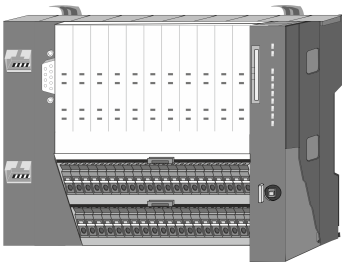

With this CPU 01xC, the CPU electronic, input/output components and power supply are integrated to one casing. In addition, up to 64 periphery modules of the System SLIO can be connected to the backplane bus. As head module via the integrated power supply CPU electronic and the I/O components are power supplied as well as the electronic of the connected periphery modules. To connect the power supply of the I/O components and for DC 24V power supply of via backplane bus connected peripheral modules, the CPU has removable connectors. By installing of up to 64 periphery modules at the backplane bus, these are electrically connected, this means these are assigned to the backplane bus, the electronic modules are power supplied and each periphery module is connected to the DC 24V power section supply.

CPU 01x



With this CPU 01x, the CPU electronic and power supply are integrated to one casing. As head module, via the integrated power module for power supply, CPU electronic and the electronic of the connected periphery modules are supplied. The DC 24 power section supply for the linked periphery modules is established via a further connection of the power module. By installing of up to 64 periphery modules at the backplane bus, these are electrically connected, this means these are assigned to the backplane bus, the electronic modules are power supplied and each periphery module is connected to the DC 24V power section supply.



CAUTION!

CPU part and power module may not be separated!
Here you may only exchange the electronic module!

Bus coupler

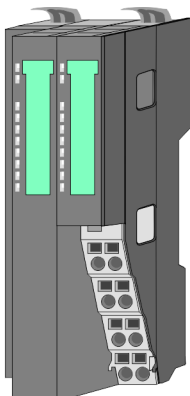

With a bus coupler bus interface and power module is integrated to one casing. With the bus interface you get access to a subordinated bus system. As head module, via the integrated power module for power supply, bus interface and the electronic of the connected periphery modules are supplied. The DC 24 power section supply for the linked periphery modules is established via a further connection of the power module. By installing of up to 64 periphery modules at the bus coupler, these are electrically connected, this means these are assigned to the backplane bus, the electronic modules are power supplied and each periphery module is connected to the DC 24V power section supply.



CAUTION!

Bus interface and power module may not be separated!
Here you may only exchange the electronic module!

Line extension

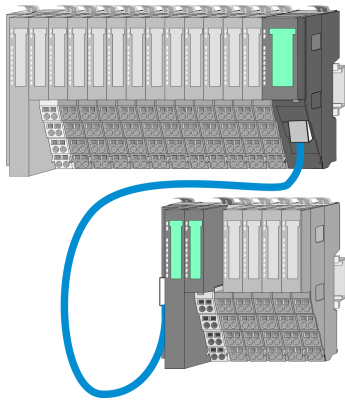

In the System SLIO there is the possibility to place up to 64 modules in on line. By means of the line extension you can divide this line into several lines. Here you have to place a line extension master at each end of a line and the subsequent line has to start with a line extension slave. Master and slave are to be connected via a special connecting cable. In this way, you can divide a line on up to 5 lines. For each line extension the maximum number of pluggable modules at the System SLIO bus is decreased by 1. To use the line extension no special configuration is required.



Please note that some modules do not support line extensions due to the system. For more information, see the 'System SLIO - Compatibility List' at www.vipa.com

Periphery modules

Each periphery module consists of a *terminal* and an *electronic module*.

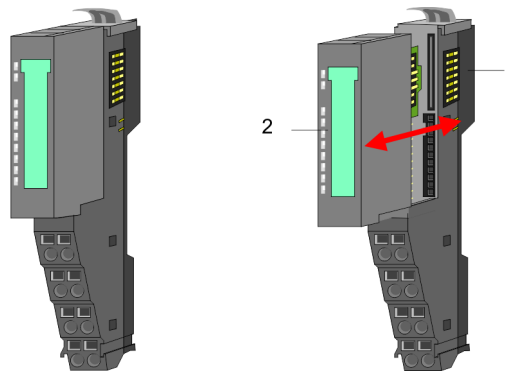

- 1 Terminal module
- 2 Electronic module

Terminal module

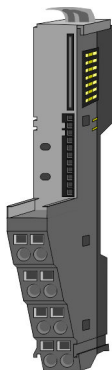

The *terminal* module serves to carry the electronic module, contains the backplane bus with power supply for the electronic, the DC 24V power section supply and the staircase-shaped terminal for wiring. Additionally the terminal module has a locking system for fixing at a mounting rail. By means of this locking system your system may be assembled outside of your switchgear cabinet to be later mounted there as whole system.

Electronic module

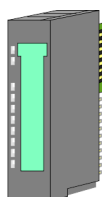

The functionality of a periphery module is defined by the *electronic* module, which is mounted to the terminal module by a sliding mechanism. With an error the defective module may be exchanged for a functional module with standing installation. At the front side there are LEDs for status indication. For simple wiring each module shows a corresponding connection diagram at the front and at the side.

2.2.3 Accessories

Shield bus carrier



The shield bus carrier (order no.: 000-0AB00) serves to carry the shield bus (10mm x 3mm) to connect cable shields. Shield bus carriers, shield bus and shield fixings are not in the scope of delivery. They are only available as accessories. The shield bus carrier is mounted underneath the terminal of the terminal module. With a flat mounting rail for adaptation to a flat mounting rail you may remove the spacer of the shield bus carrier.

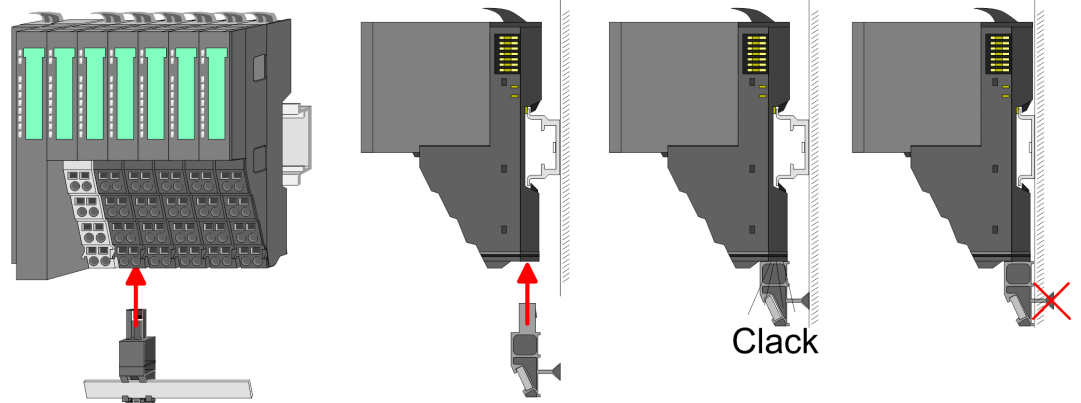

Bus cover

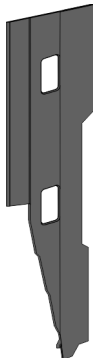

With each head module, to protect the backplane bus connectors, there is a mounted bus cover in the scope of delivery. You have to remove the bus cover of the head module before mounting a System SLIO module. For the protection of the backplane bus connector you always have to mount the bus cover at the last module of your system again. The bus cover has the order no. 000-0AA00.

Coding pins



There is the possibility to fix the assignment of electronic and terminal module. Here VIPA coding pins (order number 000-0AC00) can be used. The coding pin consists of a coding jack and a coding plug. By combining electronic and terminal module with coding pin, the coding jack remains in the electronic module and the coding plug in the terminal module. This ensures that after replacing the electronics module just another electronic module can be plugged with the same encoding.

2.2.4 Hardware revision

Hardware revision on the front

- The hardware revision version is printed on every System SLIO module.
- Since a System SLIO module consists of a terminal and electronics module, you will find a hardware revision on each of them.
- Authoritative for the hardware revision of a System SLIO module is the hardware revision of the electronic module. This is always located under the labeling strip of the corresponding electronic module.
- On modules without labeling strip, such as CPUs, the hardware revision is printed on the front.

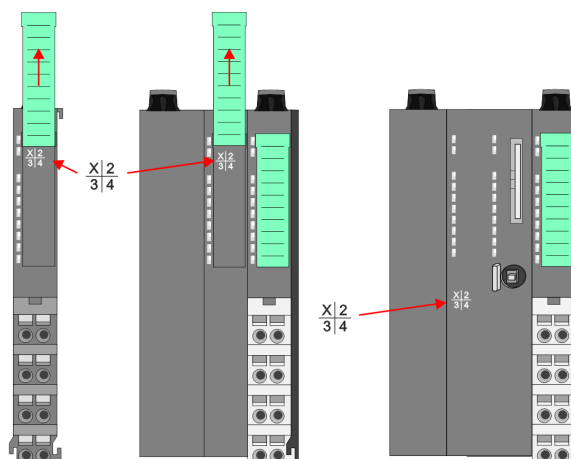

The example here shows the hardware revision 1. 1 is marked with 'X'.

Hardware revision via web server

On the CPUs and some bus couplers, you can output the hardware revision 'HW Revision' via the integrated web server.

2.3 Dimensions

Dimensions CPU 01xC

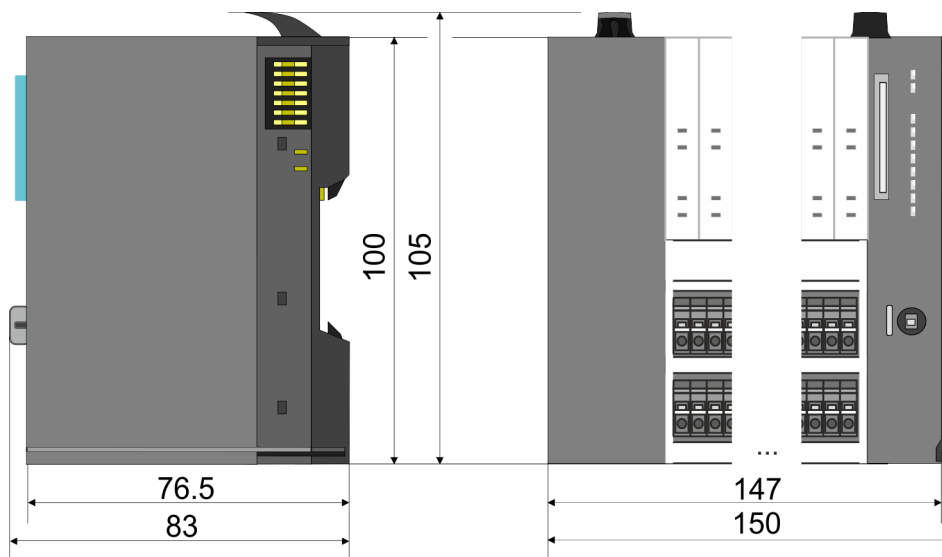

Dimensions

Dimensions CPU 01x



Dimensions bus coupler and line extension slave

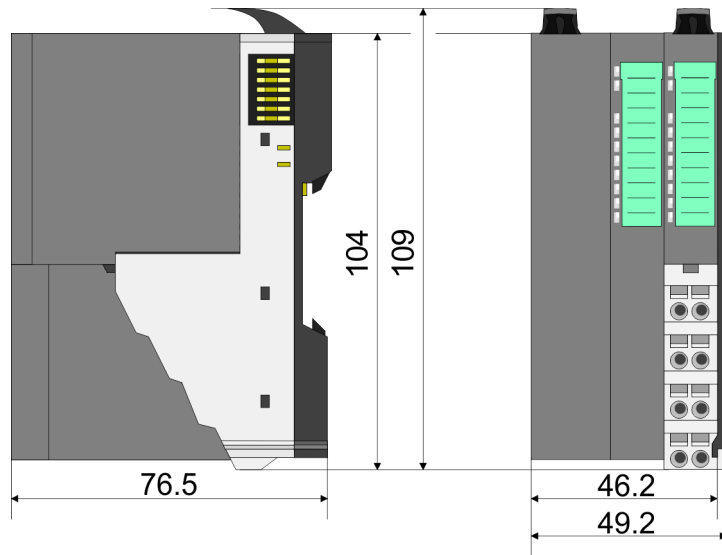

Dimensions line extension master

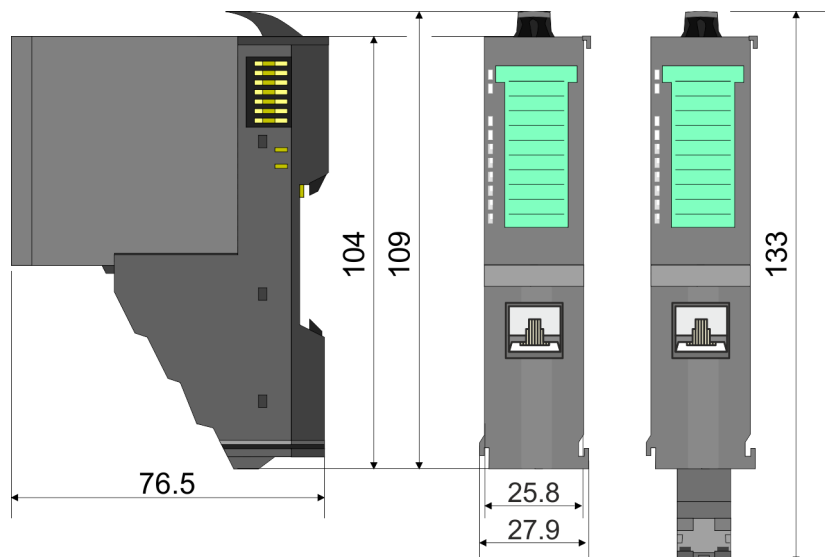

Dimension periphery module

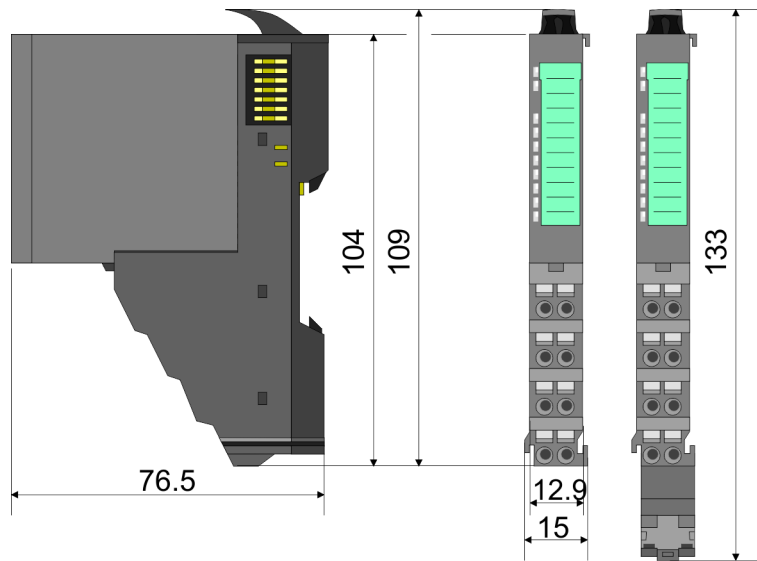

Dimensions electronic module

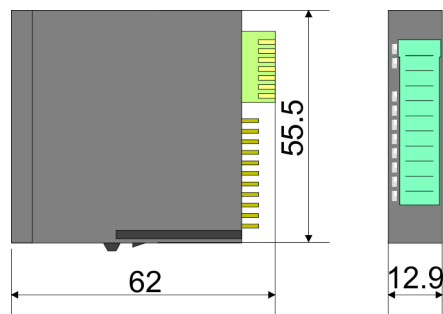

Dimensions in mm

2.4 Mounting periphery modules



Requirements for UL compliance use

- Use for power supply exclusively SELV/PELV power supplies.
- The System SLIO must be installed and operated in a housing according to IEC 61010-1 9.3.2 c).

There is a locking lever at the top side of the module. For mounting and demounting this locking lever is to be turned upwards until this engages. For mounting place the module to the module installed before and push the module to the mounting rail guided by the strips at the upper and lower side of the module. The module is fixed to the mounting rail by pushing downward the locking lever. The modules may either separately be mounted to the mounting rail or as block. Here is to be considered that each locking lever is opened. The modules are each installed on a mounting rail. The electronic and power section supply are connected via the backplane bus. Up to 64 modules may be mounted. Please consider here that the sum current of the electronic power supply does not exceed the maximum value of 3A. By means of the power module 007-1AB10 the current of the electronic power supply may be expanded accordingly.

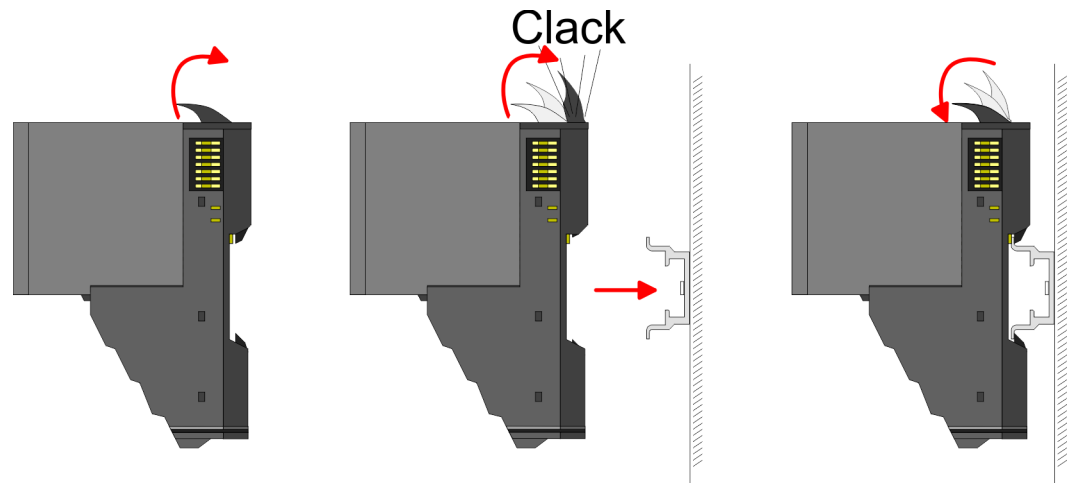

Terminal and electronic module

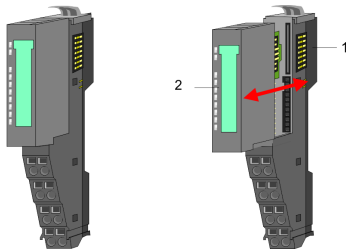

Each periphery module consists of a *terminal* and an *electronic module*.

- 1 Terminal module
- 2 Electronic module

For the exchange of a electronic module, the electronic module may be pulled forward after pressing the unlocking lever at the lower side of the module. For installation plug the electronic module guided by the strips at the lower side until this engages audible to the terminal module.

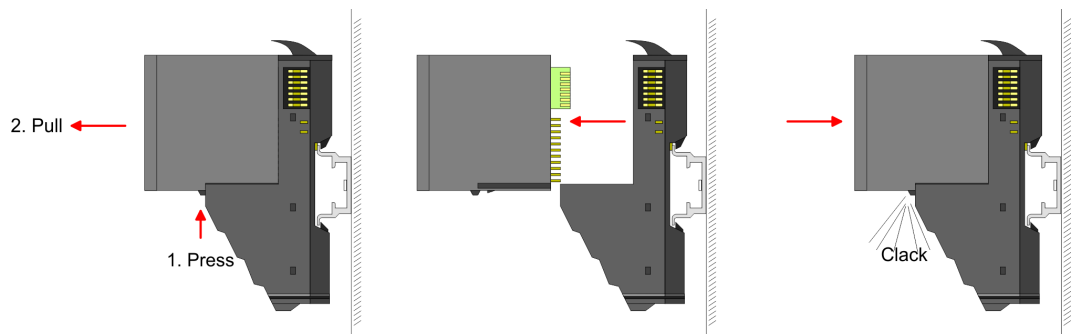

Coding



There is the possibility to fix the assignment of electronic and terminal module. Here VIPA coding pins (order number 000-0AC00) can be used. The coding pin consists of a coding jack and a coding plug. By combining electronic and terminal module with coding pin, the coding jack remains in the electronic module and the coding plug in the terminal module. This ensures that after replacing the electronics module just another electronic module can be plugged with the same encoding.

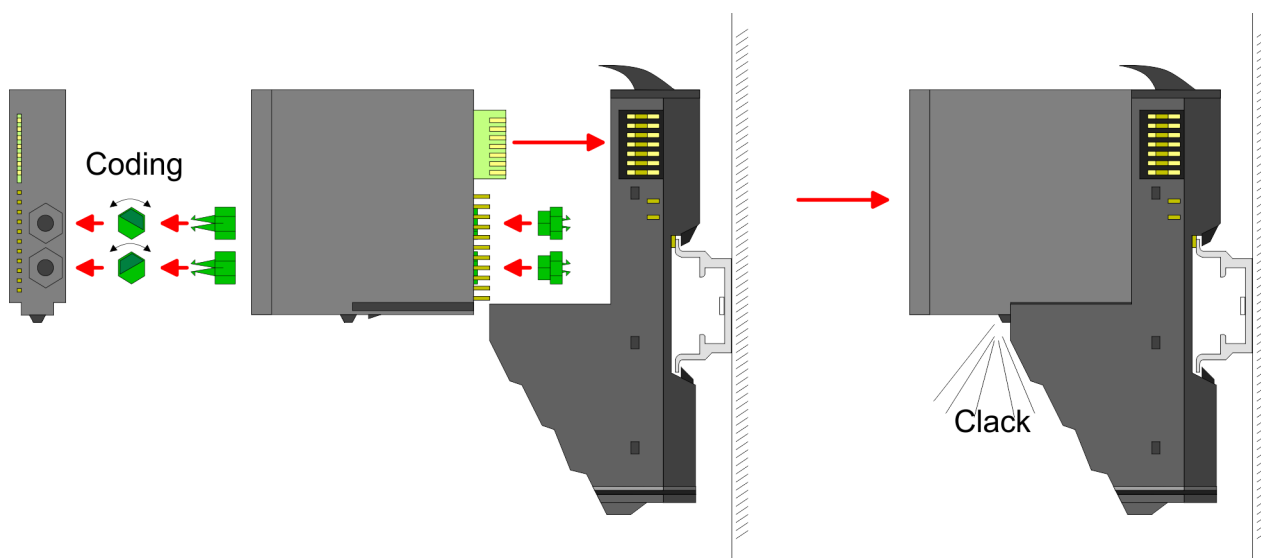

Each electronic module has on its back 2 coding sockets for coding jacks. Due to the characteristics, with the coding jack 6 different positions can be plugged, each. Thus there are 36 possible combinations for coding with the use of both coding sockets.

1. Plug, according to your coding, 2 coding jacks in the coding sockets of your electronic module until they lock
2. Now plug the according coding plugs into the coding jacks.
3. To fix the coding put both the electronic and terminal module together until they lock

**CAUTION!**

Please consider that when replacing an already coded electronic module, this is always be replaced by an electronic module with the same coding.

Even with an existing coding on the terminal module, you can plug an electronic module without coding. The user is responsible for the correct usage of the coding pins. YASKAWA assumes no liability for incorrectly attached electronic modules or for damages which arise due to incorrect coding!

Mounting periphery modules

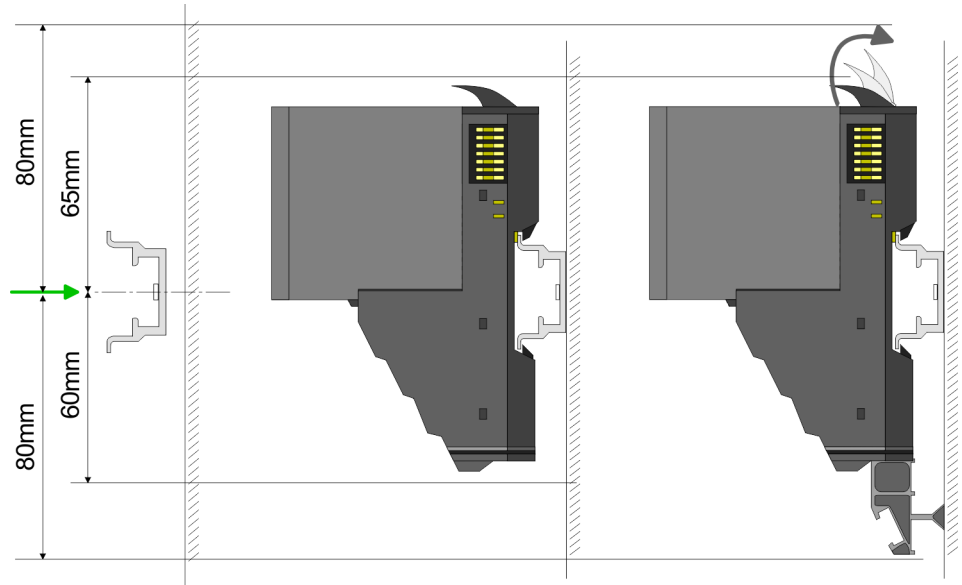

1. ➤ Mount the mounting rail! Please consider that a clearance from the middle of the mounting rail of at least 80mm above and 60mm below, respectively 80mm by deployment of shield bus carriers, exist.
2. ➤ Mount your head module such as CPU or field bus coupler.
3. ➤ Before mounting the periphery modules you have to remove the bus cover at the right side of the Head module by pulling it forward. Keep the cover for later mounting.

Clack

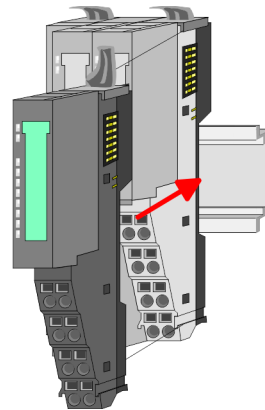
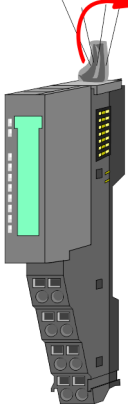

4. ➤ For mounting turn the locking lever of the module upward until it engages.
5. ➤ For mounting place the module to the module installed before and push the module to the mounting rail guided by the strips at the upper and lower side of the module.
6. ➤ Turn the locking lever of the periphery module downward, again.

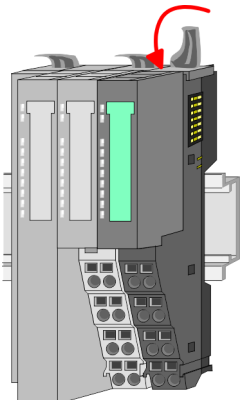

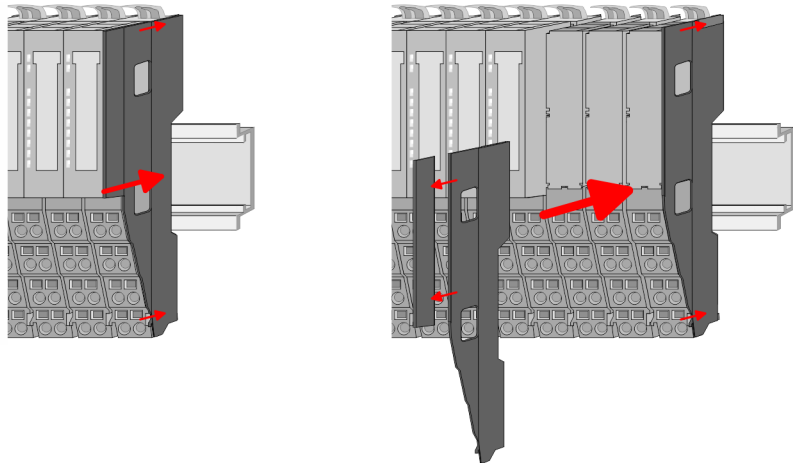

7. After mounting the whole system, to protect the backplane bus connectors at the last module you have to mount the bus cover, now. If the last module is a clamp module, for adaptation the upper part of the bus cover is to be removed.

2.5 Wiring periphery modules

Terminal module terminals



CAUTION!

Do not connect hazardous voltages!

If this is not explicitly stated in the corresponding module description, hazardous voltages are not allowed to be connected to the corresponding terminal module!

With wiring the terminal modules, terminals with spring clamp technology are used for wiring. The spring clamp technology allows quick and easy connection of your signal and supply lines. In contrast to screw terminal connections this type of connection is vibration proof.

Data

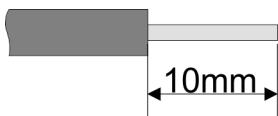

U_{max}	240V AC / 30V DC
I_{max}	10A
Cross section	0.08 ... 1.5mm ² (AWG 28 ... 16)
Stripping length	10mm

Wiring periphery modules

Wiring procedure

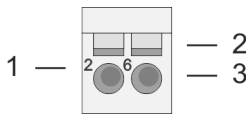

- 1 Pin number at the connector
- 2 Opening for screwdriver
- 3 Connection hole for wire

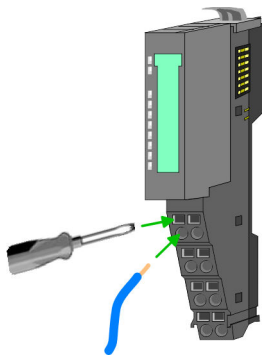
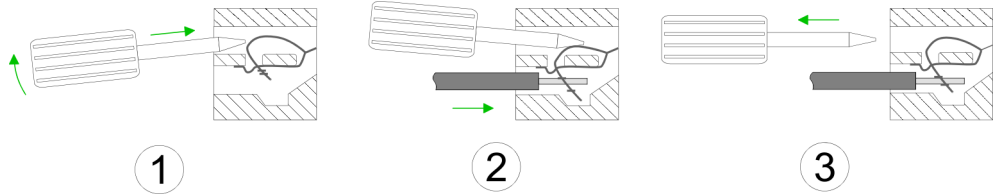

- 1. Insert a suited screwdriver at an angle into the square opening as shown. Press and hold the screwdriver in the opposite direction to open the contact spring.
- 2. Insert the stripped end of wire into the round opening. You can use wires with a cross section of 0.08mm² up to 1.5mm²
- 3. By removing the screwdriver, the wire is securely fixed via the spring contact to the terminal.

Shield attachment

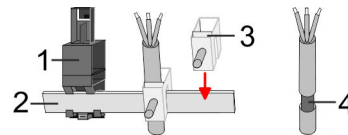

- 1 Shield bus carrier
- 2 Shield bus (10mm x 3mm)
- 3 Shield clamp
- 4 Cable shield

To attach the shield the mounting of shield bus carriers are necessary. The shield bus carrier (available as accessory) serves to carry the shield bus to connect cable shields.

- 1. Each System SLIO module has a carrier hole for the shield bus carrier. Push the shield bus carrier, until they engage into the module. With a flat mounting rail for adaptation to a flat mounting rail you may remove the spacer of the shield bus carrier.
- 2. Put your shield bus into the shield bus carrier.

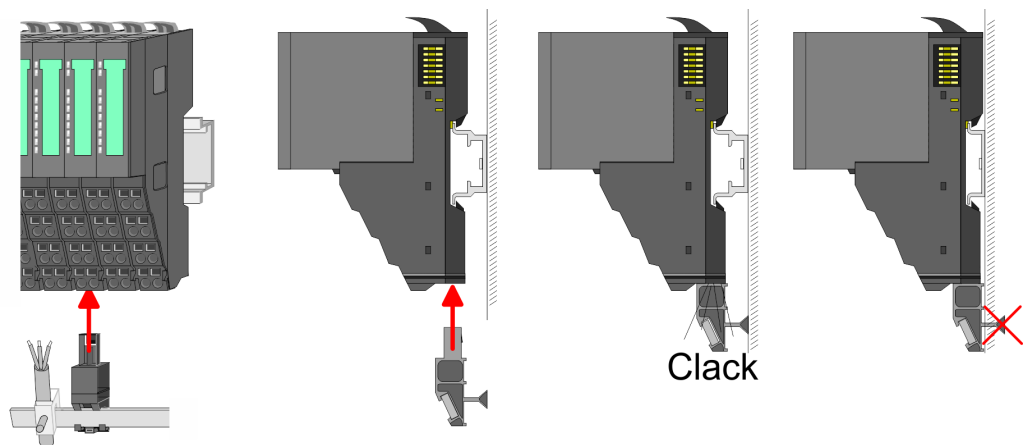

- 3. Attach the cables with the accordingly stripped cable screen and fix it by the shield clamp with the shield bus.

2.6 Wiring power modules

Terminal module terminals

Power modules are either integrated to the head module or may be installed between the periphery modules. With power modules, terminals with spring clamp technology are used for wiring. The spring clamp technology allows quick and easy connection of your signal and supply lines. In contrast to screw terminal connections this type of connection is vibration proof.

Data

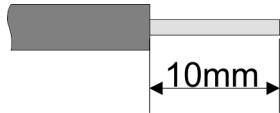

U_{max} 30V DC
 I_{max} 10A
 Cross section 0.08 ... 1.5mm² (AWG 28 ... 16)
 Stripping length 10mm

Wiring procedure

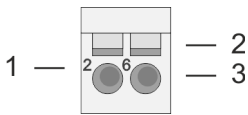

- 1 Pin number at the connector
- 2 Opening for screwdriver
- 3 Connection hole for wire

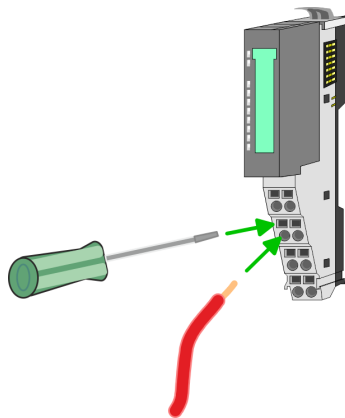
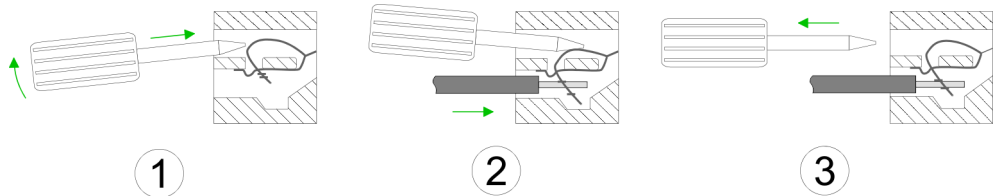

1. Insert a suited screwdriver at an angle into the square opening as shown. Press and hold the screwdriver in the opposite direction to open the contact spring.
2. Insert the stripped end of wire into the round opening. You can use wires with a cross section of 0.08mm² up to 1.5mm²
3. By removing the screwdriver, the wire is securely fixed via the spring contact to the terminal.

Standard wiring

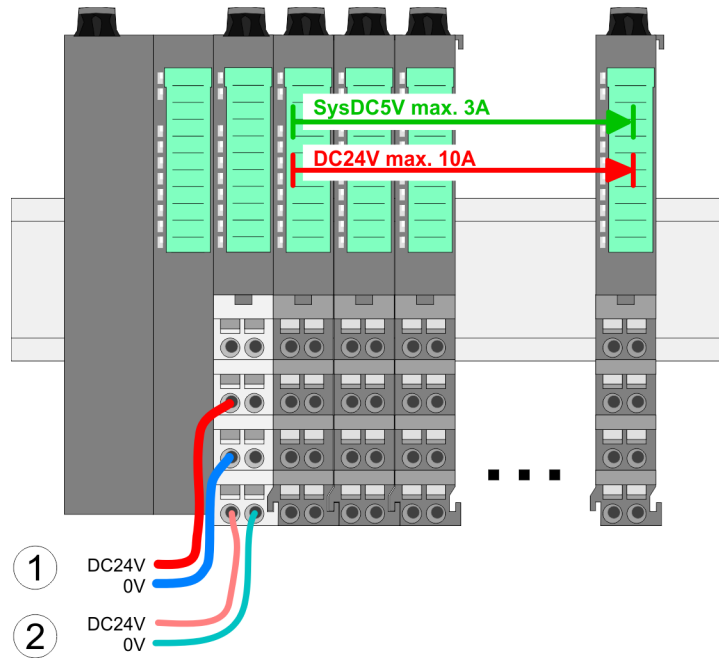

- (1) DC 24V for power section supply I/O area (max. 10A)
- (2) DC 24V for electronic power supply bus coupler and I/O area

PM - Power module

For wires with a core cross-section of 0.08mm² up to 1.5mm².

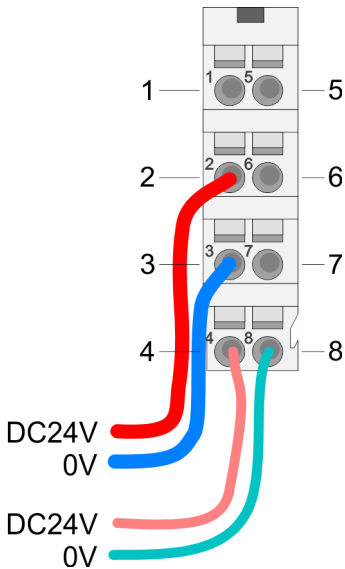

Pos.	Function	Type	Description
1	---	---	not connected
2	DC 24V	I	DC 24V for power section supply
3	0V	I	GND for power section supply
4	Sys DC 24V	I	DC 24V for electronic section supply
5	---	---	not connected
6	DC 24V	I	DC 24V for power section supply
7	0V	I	GND for power section supply
8	Sys 0V	I	GND for electronic section supply

I: Input



CAUTION!

Since the power section supply is not internally protected, it is to be externally protected with a fuse, which corresponds to the maximum current. This means max. 10A is to be protected by a 10A fuse (fast) respectively by a line circuit breaker 10A characteristics Z!



The electronic power section supply is internally protected against higher voltage by fuse. The fuse is within the power module. If the fuse releases, its electronic module must be exchanged!

Fusing

- The power section supply is to be externally protected with a fuse, which corresponds to the maximum current. This means max. 10A is to be protected with a 10A fuse (fast) respectively by a line circuit breaker 10A characteristics Z!
- It is recommended to externally protect the electronic power supply for head modules and I/O area with a 2A fuse (fast) respectively by a line circuit breaker 2A characteristics Z.
- The electronic power supply for the I/O area of the power module 007-1AB10 should also be externally protected with a 1A fuse (fast) respectively by a line circuit breaker 1A characteristics Z.

State of the electronic power supply via LEDs

After PowerON of the System SLIO the LEDs RUN respectively MF get on so far as the sum current does not exceed 3A. With a sum current greater than 3A the LEDs may not be activated. Here the power module with the order number 007-1AB10 is to be placed between the peripheral modules.

Deployment of the power modules

- If the 10A for the power section supply is no longer sufficient, you may use the power module with the order number 007-1AB00. So you have also the possibility to define isolated groups.
- The power module with the order number 007-1AB10 is to be used if the 3A for the electronic power supply at the backplane bus is no longer sufficient. Additionally you get an isolated group for the DC 24V power section supply with max. 4A.
- By placing the power module 007-1AB10 at the following backplane bus modules may be placed with a sum current of max. 2A. Afterwards a power module is to be placed again. To secure the power supply, the power modules may be mixed used.

Power module 007-1AB00

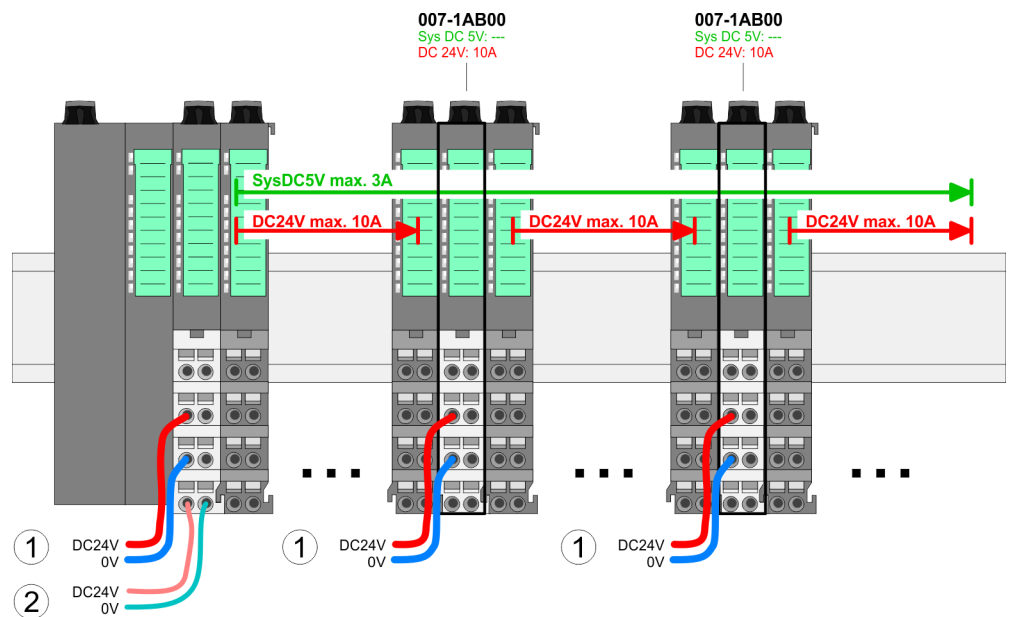

Power module 007-1AB10

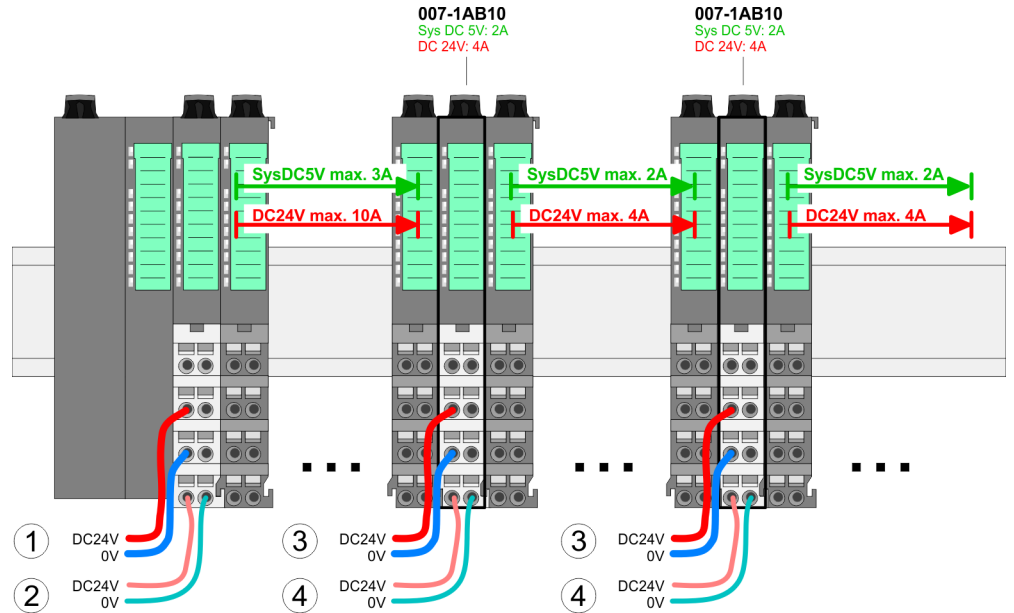

- (1) DC 24V for power section supply I/O area (max. 10A)
- (2) DC 24V for electronic power supply bus coupler and I/O area
- (3) DC 24V for power section supply I/O area (max. 4A)
- (4) DC 24V for electronic power supply I/O area

Shield attachment

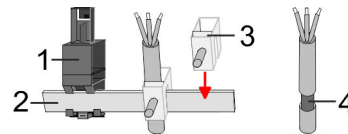

- 1 Shield bus carrier
- 2 Shield bus (10mm x 3mm)
- 3 Shield clamp
- 4 Cable shield

To attach the shield the mounting of shield bus carriers are necessary. The shield bus carrier (available as accessory) serves to carry the shield bus to connect cable shields.

- 1. ➤ Each System SLIO module has a carrier hole for the shield bus carrier. Push the shield bus carrier, until they engage into the module. With a flat mounting rail for adaptation to a flat mounting rail you may remove the spacer of the shield bus carrier.
- 2. ➤ Put your shield bus into the shield bus carrier.

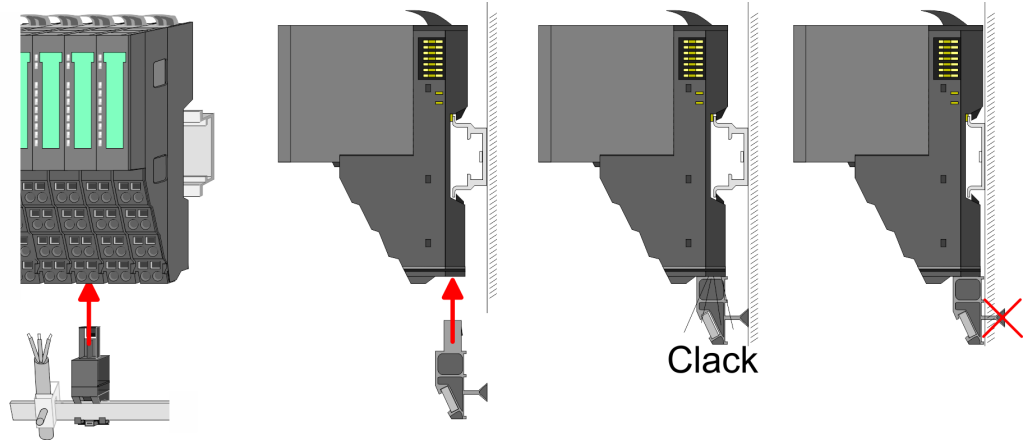

3. Attach the cables with the accordingly stripped cable screen and fix it by the shield clamp with the shield bus.

2.7 Demounting periphery modules

Proceeding

Exchange of an electronic module

1. Power-off your system.

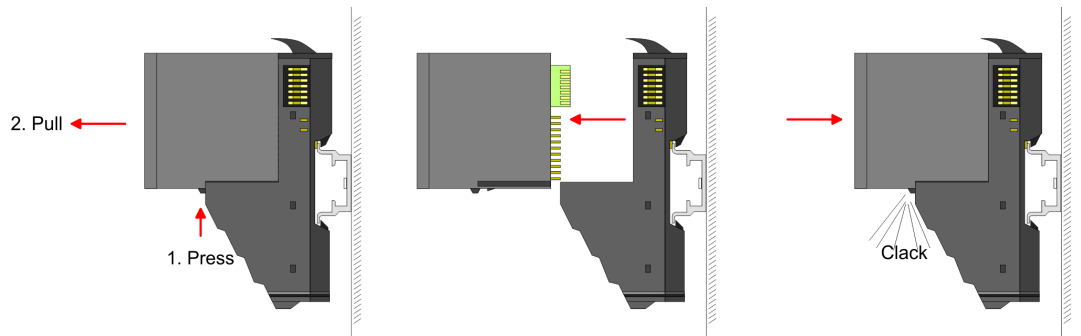

2. For the exchange of a electronic module, the electronic module may be pulled forward after pressing the unlocking lever at the lower side of the module.
3. For installation plug the new electronic module guided by the strips at the lower side until this engages to the terminal module.
⇒ Now you can bring your system back into operation.

Exchange of a periphery module

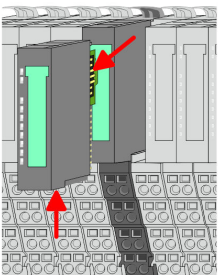

1. Power-off your system.
2. Remove if exists the wiring of the module.
- 3.



For demounting and exchange of a (head) module or a group of modules, due to mounting reasons you always have to remove the electronic module right beside. After mounting it may be plugged again.

Press the unlocking lever at the lower side of the just mounted right module and pull it forward.

Demounting periphery modules

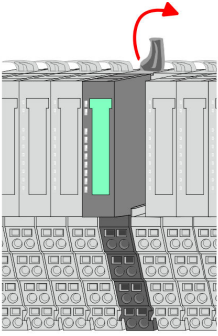

4. Turn the locking lever of the module to be exchanged upwards.

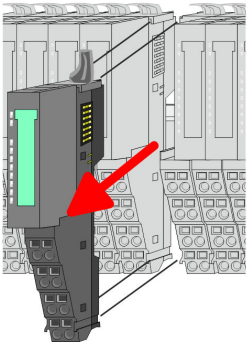

5. Pull the module.

6. For mounting turn the locking lever of the module to be mounted upwards.

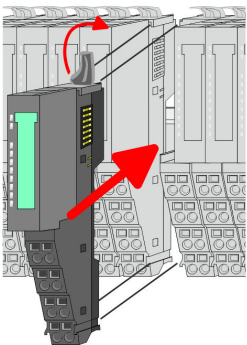

7. To mount the module put it to the gap between the both modules and push it, guided by the stripes at both sides, to the mounting rail.

8. Turn the locking lever downward, again.

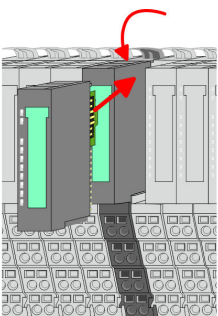

9. Plug again the electronic module, which you have removed before.

10. Wire your module.

⇒ Now you can bring your system back into operation.

Exchange of a module group

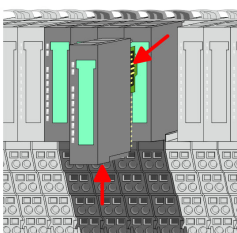

1. Power-off your system.

2. Remove if exists the wiring of the module group.

3.

i For demounting and exchange of a (head) module or a group of modules, due to mounting reasons you always have to remove the electronic module right beside. After mounting it may be plugged again.

Press the unlocking lever at the lower side of the just mounted right module near the module group and pull it forward.

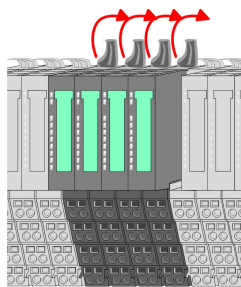

- 4.** Turn all the locking lever of the module group to be exchanged upwards.

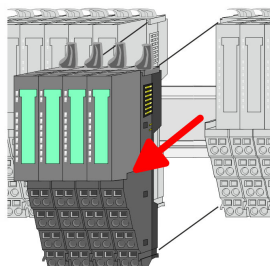

- 5.** Pull the module group forward.

- 6.** For mounting turn all the locking lever of the module group to be mounted upwards.

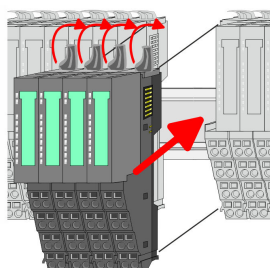

- 7.** To mount the module group put it to the gap between the both modules and push it, guided by the stripes at both sides, to the mounting rail.

- 8.** Turn all the locking lever downward, again.

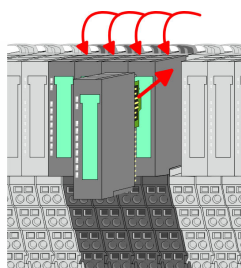

- 9.** Plug again the electronic module, which you have removed before.

- 10.** Wire your module group.

⇒ Now you can bring your system back into operation.

2.7.1 Easy Maintenance

Easy Maintenance

Easy Maintenance means the support for adding and removing modules during operation without having to restart the system. For details, refer to the manual for your head module.

2.8 Trouble shooting - LEDs

General

Each module has the LEDs RUN and MF on its front side. Errors or incorrect modules may be located by means of these LEDs.

In the following illustrations flashing LEDs are marked by ☼.

Sum current of the electronic power supply exceeded

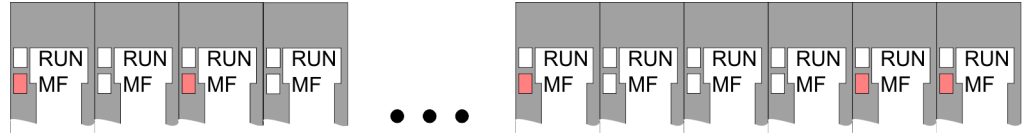

Behaviour: After PowerON the RUN LED of each module is off and the MF LED of each module is sporadically on.

Reason: The maximum current for the electronic power supply is exceeded.

Remedy: As soon as the sum current of the electronic power supply is exceeded, always place the power module 007-1AB10. ↪ Chap. 2.6 'Wiring power modules' page 23

Error in configuration

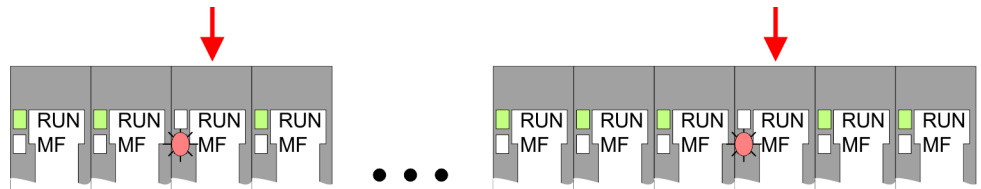

Behaviour: After PowerON the MF LED of one module respectively more modules flashes. The RUN LED remains off.

Reason: At this position a module is placed, which does not correspond to the configured module.

Remedy: Match configuration and hardware structure.

Module failure

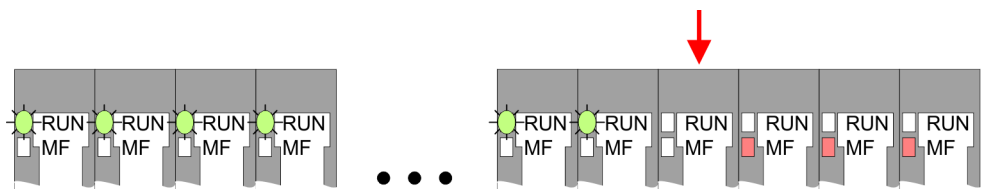

Behaviour: After PowerON all of the RUN LEDs up to the defective module are flashing. With all following modules the MF LED is on and the RUN LED is off.

Reason: The module on the right of the flashing modules is defective.

Remedy: Replace the defective module.

2.9 Installation guidelines

- General**
- The installation guidelines contain information about the interference free deployment of a PLC system. There is the description of the ways, interference may occur in your PLC, how you can make sure the electromagnetic compatibility (EMC), and how you manage the isolation.
- What does EMC mean?**
- Electromagnetic compatibility (EMC) means the ability of an electrical device, to function error free in an electromagnetic environment without being interfered respectively without interfering the environment.
- The VIPA components are developed for the deployment in industrial environments and meets high demands on the EMC. Nevertheless you should project an EMC planning before installing the components and take conceivable interference causes into account.
- Possible interference causes**
- Electromagnetic interferences may interfere your control via different ways:
- Electromagnetic fields (RF coupling)
 - Magnetic fields with power frequency
 - Bus system
 - Power supply
 - Protected earth conductor
- Depending on the spreading medium (lead bound or lead free) and the distance to the interference cause, interferences to your control occur by means of different coupling mechanisms.
- There are:
- galvanic coupling
 - capacitive coupling
 - inductive coupling
 - radiant coupling
- Basic rules for EMC**
- In the most times it is enough to take care of some elementary rules to guarantee the EMC. Please regard the following basic rules when installing your PLC.
- Take care of a correct area-wide grounding of the inactive metal parts when installing your components.
 - Install a central connection between the ground and the protected earth conductor system.
 - Connect all inactive metal extensive and impedance-low.
 - Please try not to use aluminium parts. Aluminium is easily oxidizing and is therefore less suitable for grounding.
 - When cabling, take care of the correct line routing.
 - Organize your cabling in line groups (high voltage, current supply, signal and data lines).
 - Always lay your high voltage lines and signal respectively data lines in separate channels or bundles.
 - Route the signal and data lines as near as possible beside ground areas (e.g. suspension bars, metal rails, tin cabinet).

- Proof the correct fixing of the lead isolation.
 - Data lines must be laid isolated.
 - Analog lines must be laid isolated. When transmitting signals with small amplitudes the one sided laying of the isolation may be favourable.
 - Lay the line isolation extensively on an isolation/protected earth conductor rail directly after the cabinet entry and fix the isolation with cable clamps.
 - Make sure that the isolation/protected earth conductor rail is connected impedance-low with the cabinet.
 - Use metallic or metallised plug cases for isolated data lines.
- In special use cases you should appoint special EMC actions.
 - Consider to wire all inductivities with erase links.
 - Please consider luminescent lamps can influence signal lines.
- Create a homogeneous reference potential and ground all electrical operating supplies when possible.
 - Please take care for the targeted employment of the grounding actions. The grounding of the PLC serves for protection and functionality activity.
 - Connect installation parts and cabinets with your PLC in star topology with the isolation/protected earth conductor system. So you avoid ground loops.
 - If there are potential differences between installation parts and cabinets, lay sufficiently dimensioned potential compensation lines.

Isolation of conductors

Electrical, magnetically and electromagnetic interference fields are weakened by means of an isolation, one talks of absorption. Via the isolation rail, that is connected conductive with the rack, interference currents are shunt via cable isolation to the ground. Here you have to make sure, that the connection to the protected earth conductor is impedance-low, because otherwise the interference currents may appear as interference cause.

When isolating cables you have to regard the following:

- If possible, use only cables with isolation tangle.
- The hiding power of the isolation should be higher than 80%.
- Normally you should always lay the isolation of cables on both sides. Only by means of the both-sided connection of the isolation you achieve high quality interference suppression in the higher frequency area. Only as exception you may also lay the isolation one-sided. Then you only achieve the absorption of the lower frequencies. A one-sided isolation connection may be convenient, if:
 - the conduction of a potential compensating line is not possible.
 - analog signals (some mV respectively μA) are transferred.
 - foil isolations (static isolations) are used.
- With data lines always use metallic or metallised plugs for serial couplings. Fix the isolation of the data line at the plug rack. Do not lay the isolation on the PIN 1 of the plug bar!
- At stationary operation it is convenient to strip the insulated cable interruption free and lay it on the isolation/protected earth conductor line.
- To fix the isolation tangles use cable clamps out of metal. The clamps must clasp the isolation extensively and have well contact.
- Lay the isolation on an isolation rail directly after the entry of the cable in the cabinet. Lead the isolation further on to your PLC and don't lay it on there again!



CAUTION!

Please regard at installation!

At potential differences between the grounding points, there may be a compensation current via the isolation connected at both sides.

Remedy: Potential compensation line

2.10 General data for the System SLIO

Conformity and approval

Conformity		
CE	2014/35/EU	Low-voltage directive
	2014/30/EU	EMC directive
Approval		
UL	-	Refer to Technical data
Others		
RoHS	2011/65/EU	Restriction of the use of certain hazardous substances in electrical and electronic equipment

Protection of persons and device protection

Type of protection	-	IP20
Electrical isolation		
to the field bus	-	electrically isolated
to the process level	-	electrically isolated
Insulation resistance	-	-
Insulation voltage to reference earth		
Inputs / outputs	-	AC / DC 50V, test voltage AC 500V
Protective measures	-	against short circuit

Environmental conditions to EN 61131-2

Climatic		
Storage / transport	EN 60068-2-14	-25...+70°C
Operation		
Horizontal installation hanging	EN 61131-2	0...+60°C
Horizontal installation lying	EN 61131-2	0...+55°C
Vertical installation	EN 61131-2	0...+50°C
Air humidity	EN 60068-2-30	RH1 (without condensation, rel. humidity 10...95%)
Pollution	EN 61131-2	Degree of pollution 2
Installation altitude max.	-	2000m
Mechanical		
Oscillation	EN 60068-2-6	1g, 9Hz ... 150Hz
Shock	EN 60068-2-27	15g, 11ms

General data for the System SLIO

Mounting conditions

Mounting place	-	In the control cabinet
Mounting position	-	Horizontal and vertical

EMC	Standard	Comment	
Emitted interference	EN 61000-6-4	Class A (Industrial area)	
Noise immunity zone B	EN 61000-6-2	Industrial area	
		EN 61000-4-2	ESD 8kV at air discharge (degree of severity 3), 4kV at contact discharge (degree of severity 2)
		EN 61000-4-3	HF field immunity (casing) 80MHz ... 1000MHz, 10V/m, 80% AM (1kHz) 1.4GHz ... 2.0GHz, 3V/m, 80% AM (1kHz) 2GHz ... 2.7GHz, 1V/m, 80% AM (1kHz)
		EN 61000-4-6	HF conducted 150kHz ... 80MHz, 10V, 80% AM (1kHz)
		EN 61000-4-4	Burst, degree of severity 3
		EN 61000-4-5	Surge, degree of severity 3 *

*) Due to the high-energetic single pulses with Surge an appropriate external protective circuit with lightning protection elements like conductors for lightning and overvoltage is necessary.

3 Analog Input

3.1 General

Cables for analog signals

For analog signals you should use screened cables to reduce interference. The cable screening should be grounded at both ends. If there are differences in the potential between the cable ends, there may occur a potential compensating current that could disturb the analog signals. In this case you should ground the cable screening only at one end.

Connecting sensors

Depending on the module the following sensors may be connected to the analog input modules:

- Current sensor
- Voltage sensor
- Resistance-type sensors
- Temperature sensors



*Please take care of the correct polarity when installing the sensors!
Please install short circuits at non-used inputs by connecting the positive contact with the channel ground of the according channel.*

Parameterization

The parameterization via CPU, PROFIBUS and PROFINET happens by means of record sets (DS). The corresponding record set number may be found at the respective module description. Here also the indices (IX) respectively subindices (SX) for CANopen respectively EtherCAT are listed.

Diagnostic functions

The modules have diagnostics capability. The following errors can release a diagnostic:

- Error in parameterization
- Measuring range over-/underflow
- Wire break



Alternated blinking of the channel error LEDs

The alternate blinking of the channel error LEDs of channel 0 and 1 indicates a watchdog error due to a system overload. Restart with a power cycle your system. If the error occurred again, check configuration and circuit and adjust them if necessary. If the error persists, please contact our support.

3.2 Analog value

Representation of analog values

Analog values are exclusively processed in a binary format. For this the analog module transforms every process signal into a digital value and transfers this as word. The analog values are displayed as a fixed-point number in the two's complement.

Resolution	Analog value															
	High byte (byte 0)								Low byte (byte 1)							
Bit number	15	14	13	12	11	10	9	8	7	6	5	4	3	2	1	0
Value	SG	2^{14}	2^{13}	2^{12}	2^{11}	2^{10}	2^9	2^8	2^7	2^6	2^5	2^4	2^3	2^2	2^1	2^0
12Bit	SG	Measuring value												0	0	0
15Bit	SG	Measuring value														

Resolution

With a resolution of 12bit plus sign bit, the not used low value positions (3bits) are filled with "0".

Sign bit (SG)

Here it is essential:

- Bit 15 = "0": → positive value
- Bit 15 = "1": → negative value

Behavior at error

As soon as a measured value exceeds the overdrive region respectively falls below the underdrive region, the following value is issued:

- Measuring value > end of overdrive region:
32767 (7FFFh)
- Measuring value < end of underdrive region:
-32768 (8000h)

At a parameterization error the value 32767 (7FFFh) is issued.

3.3 Measuring ranges and function numbers

General

In the following there are the measuring ranges with function number listed, which were supported by the corresponding analog module.

The here listed formulas allow you to transform an evaluated measuring value (digital value) to a value assigned to the measuring range and vice versa.

Voltage

-80 ... 80mV

Meas. range (funct. no.)	Voltage (U)	Decimal (D)	Hex	Range	Formulas
-80 ... 80mV Siemens S7 format (11h)	94.07mV	32511	7EFFh	overrange	$D = 27648 \cdot \frac{U}{80}$ $U = D \cdot \frac{80}{27648}$
	80mV	27648	6C00h	nominal range	
	0V	0	0000h		
	-80mV	-27648	9400h		
	-94.07mV	-32512	8100h	underrange	
-80 ... 80mV Siemens S5 format (21h)	100mV	20480	5000h	overrange	$D = 16384 \cdot \frac{U}{80}$ $U = D \cdot \frac{80}{16384}$
	80mV	16384	4000h	nominal range	
	0V	0	0000h		
	-80mV	-16384	C000h		
	-100mV	-20480	B000h	underrange	

0 ... 10V

Meas. range (funct. no.)	Voltage (U)	Decimal (D)	Hex	Range	Formulas
0 ... 10V Siemens S7 format (10h)	11.76V	32511	7EFFh	overrange	$D = 27648 \cdot \frac{U}{10}$ $U = D \cdot \frac{10}{27648}$
	10V	27648	6C00h	nominal range	
	5V	13824	3600h		
	0V	0	0000h		
	-1.76V	-4864	ED00h	underrange	
0 ... 10V Siemens S5 format (20h)	12.5V	20480	5000h	overrange	$D = 16384 \cdot \frac{U}{10}$ $U = D \cdot \frac{10}{16384}$
	10V	16384	4000h	nominal range	
	5V	8192	2000h		
	0V	0	0000h		
	-2V	-3277	F333h	underrange	

Measuring ranges and function numbers

±10V

Meas. range (funct. no.)	Voltage (U)	Decimal (D)	Hex	Range	Formulas
±10V Siemens S7 format (12h)	11.76V	32511	7EFFh	overrange	$D = 27648 \cdot \frac{U}{10}$ $U = D \cdot \frac{10}{27648}$
	10V	27648	6C00h	nominal range	
	5V	13824	3600h		
	0V	0	0000h		
	-5V	-13824	CA00h		
	-10V	-27648	9400h		
	-11.76V	-32512	8100h	underrange	
±10V Siemens S5 format (22h)	12.5V	20480	5000h	overrange	$D = 16384 \cdot \frac{U}{10}$ $U = D \cdot \frac{10}{16384}$
	10V	16384	4000h	nominal range	
	5V	8192	2000h		
	0V	0	0000h		
	-5V	-8192	E000h		
	-10V	-16384	C000h		
	-12.5V	-20480	B000h	underrange	

Current

0(4) ... 20mA

Meas. range (funct. no.)	Current (I)	Decimal (D)	Hex	Range	Formulas
0 ... 20mA Siemens S7 format (31h)	23.52mA	32511	7EFFh	overrange	$D = 27648 \cdot \frac{I}{20}$ $I = D \cdot \frac{20}{27648}$
	20mA	27648	6C00h	nominal range	
	10mA	13824	3600h		
	0mA	0	0000h		
	-3.52mA	-4864	ED00h	underrange	
0 ... 20mA Siemens S5 format (41h)	25.00mA	20480	5000h	overrange	$D = 16384 \cdot \frac{I}{20}$ $I = D \cdot \frac{20}{16384}$
	20mA	16384	4000h	nominal range	
	10mA	8192	2000h		
	0mA	0	0000h		
	-4,00mA	-3277	F333h	underrange	
4 ... 20mA Siemens S7 format (30h)	22.81mA	32511	7EFFh	overrange	$D = 27648 \cdot \frac{I-4}{16}$ $I = D \cdot \frac{16}{27648} + 4$
	20mA	27648	6C00h	nominal range	
	12mA	13824	3600h		
	4mA	0	0000h		
	1.19mA	-4864	ED00h	underrange	
4 ... 20mA Siemens S5 format (40h)	24.00mA	20480	5000h	overrange	$D = 16384 \cdot \frac{I-4}{16}$ $I = D \cdot \frac{16}{16384} + 4$
	20mA	16384	4000h	nominal range	
	12mA	8192	2000h		
	4mA	0	0000h		
	0.8mA	-3277	F333h	underrange	

0 ... 20mA / 4KM format

Meas. range (funct. no.)	Current (I)	Decimal (D)	Hex	Range	Formulas
0 ... 20mA 4KM format (3Fh)	20.457mA	4095	0FFFh	overrange	$D = 4000 \cdot \frac{I}{20}$ $I = D \cdot \frac{20}{4000}$
	20mA	4000	0FA0h	nominal range	
	10mA	2000	07D0h		
	0mA	0	0000h		
	---			underrange	

Measuring ranges and function numbers

Resistance

Measuring range (funct. no.)	Measuring value	Signal range	Range
2 wire: PT100 (50h)	+1000°C	+10000	overrange
	-200 ... +850°C	-2000 ... +8500	nominal range
	-243°C	-2430	underrange
2 wire: PT1000 (51h)	+1000°C	+10000	overrange
	-200 ... +850°C	-2000 ... +8500	nominal range
	-243°C	-2430	underrange
2 wire: NI100 (52h)	+295°C	+2950	overrange
	-60 ... +250°C	-600 ... +2500	nominal range
	-105°C	-1050	underrange
2 wire: NI1000 (53h)	+295°C	+2950	overrange
	-60 ... +250°C	-600 ... +2500	nominal range
	-105°C	-1050	underrange
2 wire: NI120 (54h)	+300°C	+3000	overrange
	-80 ... +260°C	-800 ... +2600	nominal range
	-110°C	-1100	underrange
3 wire: PT100 (58h)	+1000°C	+10000	overrange
	-200 ... +850°C	-2000 ... +8500	nominal range
	-243°C	-2430	underrange
3 wire: PT1000 (59h)	+1000°C	+10000	overrange
	-200 ... +850°C	-2000 ... +8500	nominal range
	-243°C	-2430	underrange
3 wire: NI100 (5Ah)	+295°C	+2950	overrange
	-60 ... +250°C	-600 ... +2500	nominal range
	-105°C	-1050	underrange
3 wire: NI1000 (5Bh)	+295°C	+2950	overrange
	-60 ... +250°C	-600 ... +2500	nominal range
	-105°C	-1050	underrange
3 wire: NI120 (5Ch)	+300°C	+3000	overrange
	-80 ... +260°C	-800 ... +2600	nominal range
	-110°C	-1100	underrange
4 wire: PT100 (60h)	+1000°C	+10000	overrange
	-200 ... +850°C	-2000 ... +8500	nominal range
	-243°C	-2430	underrange
4 wire: PT1000	+1000°C	+10000	overrange

Measuring range (funct. no.)	Measuring value	Signal range	Range
(61h)	-200 ... +850°C	-2000 ... +8500	nominal range
	-243°C	-2430	underrange
4 wire: NI100 (62h)	+295°C	+2950	overrange
	-60 ... +250°C	-600 ... +2500	nominal range
4 wire: NI1000 (63h)	-105°C	-1050	underrange
	+295°C	+2950	overrange
	-60 ... +250°C	-600 ... +2500	nominal range
4 wire: NI120 (64h)	-105°C	-1050	underrange
	+300°C	+3000	overrange
	-80 ... +260°C	-800 ... +2600	nominal range
2 wire: 0 ... 60Ω (70h)	-110°C	-1100	underrange
	---	---	overrange
	0 ... 60Ω	0 ... 32767	nominal range
2 wire: 0 ... 600Ω (71h)	---	---	underrange
	---	---	overrange
	0 ... 600Ω	0 ... 32767	nominal range
2 wire: 0 ... 3000Ω (72h)	---	---	underrange
	---	---	overrange
	0 ... 3000Ω	0 ... 32767	nominal range
3 wire: 0 ... 60Ω (78h)	---	---	underrange
	---	---	overrange
	0 ... 60Ω	0 ... 32767	nominal range
3 wire: 0 ... 600Ω (79h)	---	---	underrange
	---	---	overrange
	0 ... 600Ω	0 ... 32767	nominal range
3 wire: 0 ... 3000Ω (7Ah)	---	---	underrange
	---	---	overrange
	0 ... 3000Ω	0 ... 32767	nominal range
4 wire: 0 ... 60Ω (80h)	---	---	underrange
	---	---	overrange
	0 ... 60Ω	0 ... 32767	nominal range
4 wire: 0 ... 600Ω (81h)	---	---	underrange
	---	---	overrange
	0 ... 600Ω	0 ... 32767	nominal range
	---	---	underrange
	---	---	overrange

Measuring ranges and function numbers

Measuring range (funct. no.)	Measuring value	Signal range	Range
4 wire: 0 ... 3000Ω (82h)	---	---	overrange
	0 ... 3000Ω	0 ... 32767	nominal range
	---	---	underrange
2 wire: 0 ... 60Ω (90h)	---	---	overrange
	0 ... 60Ω	0 ... 6000	nominal range
	---	---	underrange
2 wire: 0 ... 600Ω (91h)	---	---	overrange
	0 ... 600Ω	0 ... 6000	nominal range
	---	---	underrange
2 wire: 0 ... 3000Ω (92h)	---	---	overrange
	0 ... 3000Ω	0 ... 30000	nominal range
	---	---	underrange
3 wire: 0 ... 60Ω (98h)	---	---	overrange
	0 ... 60Ω	0 ... 6000	nominal range
	---	---	underrange
3 wire: 0 ... 600Ω (99h)	---	---	overrange
	0 ... 600Ω	0 ... 6000	nominal range
	---	---	underrange
3 wire: 0 ... 3000Ω (9Ah)	---	---	overrange
	0 ... 3000Ω	0 ... 30000	nominal range
	---	---	underrange
4 wire: 0 ... 60Ω (A0h)	---	---	overrange
	0 ... 60Ω	0 ... 6000	nominal range
	---	---	underrange
4 wire: 0 ... 600Ω (A1h)	---	---	overrange
	0 ... 600Ω	0 ... 6000	nominal range
	---	---	underrange
4 wire: 0 ... 3000Ω (A2h)	---	---	overrange
	0 ... 3000Ω	0 ... 30000	nominal range
	---	---	underrange
2 wire: 0 ... 60Ω (D0h)	70.55Ω	32511	overrange
	0 ... 60Ω	0 ... 27648	nominal range
	---	---	underrange
2 wire: 0 ... 600Ω (D1h)	705.5Ω	32511	overrange
	0 ... 600Ω	0 ... 27648	nominal range

Measuring range (funct. no.)	Measuring value	Signal range	Range
	---	---	underrange
2 wire: 0 ... 3000Ω (D2h)	3528Ω	32511	overrange
	0 ... 3000Ω	0 ... 27648	nominal range
	---	---	underrange
3 wire: 0 ... 60Ω (D8h)	70.55Ω	32511	overrange
	0 ... 60Ω	0 ... 27648	nominal range
	---	---	underrange
3 wire: 0 ... 600Ω (D9h)	705.5Ω	32511	overrange
	0 ... 600Ω	0 ... 27648	nominal range
	---	---	underrange
3 wire: 0 ... 3000Ω (DAh)	3528Ω	32511	overrange
	0 ... 3000Ω	0 ... 27648	nominal range
	---	---	underrange
4 wire: 0 ... 60Ω (E0h)	70.55Ω	32511	overrange
	0 ... 60Ω	0 ... 27648	nominal range
	---	---	underrange
4 wire: 0 ... 600Ω (E1h)	705.5Ω	32511	overrange
	0 ... 600Ω	0 ... 27648	nominal range
	---	---	underrange
4 wire: 0 ... 3000Ω (E2h)	3528Ω	32511	overrange
	0 ... 3000Ω	0 ... 27648	nominal range
	---	---	underrange

Temperature

Measuring range (funct. no.)	Measuring value in °C (0.1°C/digit)	Measuring value in °F (0.1°F/digit)	Measuring value in K (0.1K/digit)	Range
Type J:	+14500	26420	17232	overrange
[Fe-Cu-Ni IEC]	-2100 ... +12000	-3460 ... 21920	632 ... 14732	nominal range
-210 ... +1200°C	---	---	---	underrange
-346 ... 2192°F				
63.2 ... 1473.2K				
(B0h: ext. comp. 0°C)				
(C0h: int. comp. 0°C)				
Type K:	+16220	29516	18952	overrange

Measuring ranges and function numbers

Measuring range (funct. no.)	Measuring value in °C (0.1°C/digit)	Measuring value in °F (0.1°F/digit)	Measuring value in K (0.1K/digit)	Range
[Ni-Cr-Ni]	-2700 ... +13720	-4540 ... 25016	0 ... 16452	nominal range
-270 ... +1372°C	---	---	---	underrange
-454 ... 2501.6°F				
0 ... 1645.2K				
(B1h: ext. comp. 0°C)				
(C1h: int. comp. 0°C)				
Type N:	+15500	28220	18232	overrange
[Ni-Cr-Si]	-2700 ... +13000	-4540 ... 23720	0 ... 15732	nominal range
-270 ... +1300°C	---	---	---	underrange
-454 ... 2372°F				
0 ... 1573.2K				
(B2h: ext. comp. 0°C)				
(C2h: int. comp. 0°C)				
Type R:	+20190	32766	22922	overrange
[PtRh-Pt]	-500 ... +17690	-580 ... 32162	2232 ... 20422	nominal range
-50 ... +1769°C	-1700	-2740	1032	underrange
-58 ... 3216.2°F				
223.2 ... 2042.2K				
(B3h: ext. comp. 0°C)				
(C3h: int. comp. 0°C)				
Type S:	+20190	32766	22922	overrange
[PtRh-Pt]	-500 ... +17690	-580 ... 32162	2232 ... 20422	nominal range
-50 ... +1769°C	-1700	-2740	1032	underrange
-58 ... 3216.2°F				
223.2 ... 2042.2K				
(B4h: ext. comp. 0°C)				
(C4h: int. comp. 0°C)				
Type T:	+5400	10040	8132	overrange
[Cu-Cu-Ni]	-2700 ... +4000	-4540 ... 7520	32 ... 6732	nominal range
-270 ... +400°C	---	---	---	underrange
-454 ... 752°F				
3.2 ... 673.2K				
(B5h: ext. comp. 0°C)				
(C5h: int. comp. 0°C)				
Type B:	+20700	32766	23432	overrange
[PtRh-PtRh]	0 ... +18200	320 ... 27865	2732 ... 20932	nominal range
0 ... +1820°C				
32 ... 2786.5°F				

Measuring range (funct. no.)	Measuring value in °C (0.1°C/digit)	Measuring value in °F (0.1°F/digit)	Measuring value in K (0.1K/digit)	Range
273.2 ... 2093.2K (B6h: ext. comp. 0°C) (C6h: int. comp. 0°C)	-1200	-1840	1532	underrange
Type C:	+25000	32766	23432	overrange
[WRe5-WRe26]	0 ... +23150	320 ... 27865	2732 ... 20932	nominal range
0 ... +2315°C 32 ... 2786.5°F 273.2 ... 2093.2K (B7h: ext. comp. 0°C) (C7h: int. comp. 0°C)	-1200	-1840	1532	underrange
Type E:	+12000	21920	14732	overrange
[Ni-Cr - Cu-Ni]	-2700 ... +10000	-4540 ... 18320	0 ... 12732	nominal range
-270 ... +1000°C -454 ... 1832°F 0 ... 1273.2K (B8h: ext. comp. 0°C) (C8h: int. comp. 0°C)	---	---	---	underrange
Type L:	+11500	21020	14232	overrange
[Fe-Cu-Ni]	-2000 ... +9000	-3280 ... 16520	732 ... 11732	nominal range
-200 ... +900°C -328 ... 1652°F 73.2 ... 1173.2K (B9h: ext. comp. 0°C) (C9h: int. comp. 0°C)	---	---	---	underrange

3.4 031-1BB10 - AI 2x12Bit 0(4)...20mA - ISO

Properties

The electronic module has 2 inputs with parameterizable functions. The channels of the module are electrically isolated from the backplane bus. The sensor supplies are isolated from each other and via DC/DC converter from the DC 24V power supply.

- 2 galvanically separated analog inputs
- Integrated sensor supply for each channel max. 35mA, (short circuit to 39mA)
- Suited for sensors with 0 ... 20mA; 4 ... 20mA
- Interrupt and diagnostics function
- 12bit resolution

Structure

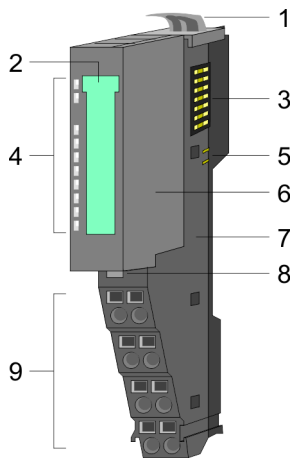

- 1 Locking lever terminal module
- 2 Labeling strip
- 3 Backplane bus
- 4 LED status indication
- 5 DC 24V power section supply
- 6 Electronic module
- 7 Terminal module
- 8 Locking lever electronic module
- 9 Terminal

Status indication

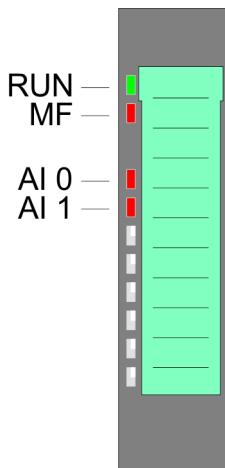

RUN	MF	AI x	Description
■ green	■ red	■ red	
■	<input type="checkbox"/>	X	Bus communication is OK Module status is OK
■	■	X	Bus communication is OK Module status reports an error
<input type="checkbox"/>	■	X	Bus communication is not possible Module status reports an error
<input type="checkbox"/>	<input type="checkbox"/>	X	Error at bus power supply
X	▣ 2Hz	X	Error in configuration Chap. 2.8 'Trouble shooting - LEDs' page 30
■	<input type="checkbox"/>	■	Error channel x <ul style="list-style-type: none"> ■ Signal leaves measuring range ■ Error in parameterization ■ Overload/short circuit of the DC 24V_ISO
not relevant: X			

Pin assignment

For wires with a cross section of 0.08mm² up to 1.5mm².

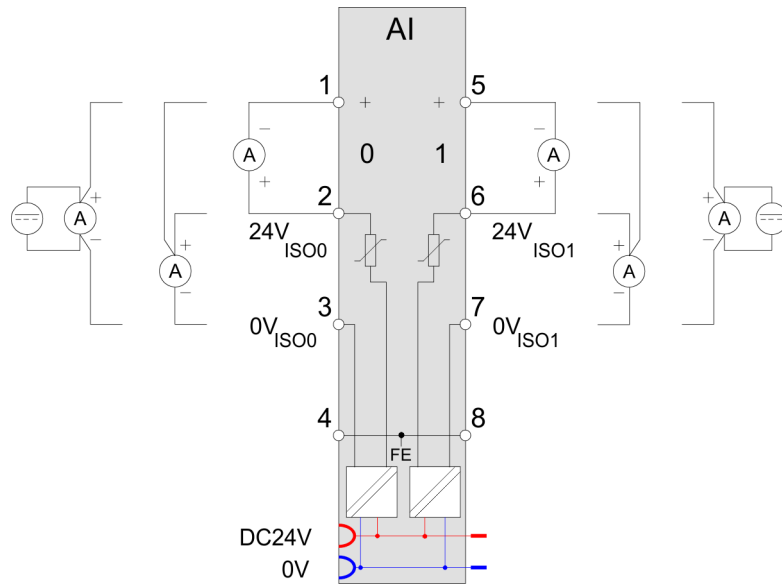
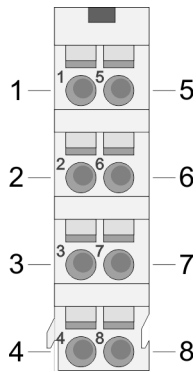

Pos.	Function	Type	Description
1	+AI 0	I	+ Channel 0
2	24V_ISO_0	O	DC 24V encoder supply Channel 0
3	0V_ISO_0	O	Ground channel 0
4	FE	---	Shield
5	AI 1	I	+ Channel 1
6	24V_ISO_1	O	DC 24V encoder supply Channel 1
7	0V_ISO_1	O	Ground Channel 1
8	FE	---	Shield

I: Input, O: Output

In-/Output area

At CPU, PROFIBUS and PROFINET the input respectively output area is embedded to the corresponding address area.

IX - Index for access via CANopen with s = Subindex, depends on number and type of analog modules

SX - Subindex for access via EtherCAT with Index 6000h + EtherCAT-Slot

More can be found in the according manual of your bus coupler.

Input area

Addr.	Name	Bytes	Function	IX	SX
+0	AI 0	2	Analog value channel 0	6401h/s	01h
+2	AI 1	2	Analog value channel 1	6401h/s+1	02h

Output area

No byte of the output area is used by the module.

3.4.1 Technical data

Order no.	031-1BB10
Type	SM 031
Module ID	0411 1543
Current consumption/power loss	
Current consumption from backplane bus	50 mA
Power loss	0.7 W
Technical data analog inputs	
Number of inputs	2
Cable length, shielded	200 m
Rated load voltage	DC 24 V
Current consumption from load voltage L+ (without load)	20 mA
Voltage inputs	-
Min. input resistance (voltage range)	-
Input voltage ranges	-
Operational limit of voltage ranges	-
Operational limit of voltage ranges with SFU	-
Basic error limit voltage ranges	-
Basic error limit voltage ranges with SFU	-
Destruction limit voltage	-
Current inputs	✓
Max. input resistance (current range)	60 Ω
Input current ranges	+4 mA ... +20 mA 0 mA ... +20 mA
Operational limit of current ranges	+/-0.5%
Operational limit of current ranges with SFU	-
Basic error limit current ranges	+/-0.3%
Radical error limit current ranges with SFU	-
Destruction limit current inputs (voltage)	max. 24V
Destruction limit current inputs (electrical current)	max. 40mA
Resistance inputs	-
Resistance ranges	-
Operational limit of resistor ranges	-
Operational limit of resistor ranges with SFU	-
Basic error limit	-
Basic error limit with SFU	-
Destruction limit resistance inputs	-

Order no.	031-1BB10
Resistance thermometer inputs	-
Resistance thermometer ranges	-
Operational limit of resistance thermometer ranges	-
Operational limit of resistance thermometer ranges with SFU	-
Basic error limit thermoresistor ranges	-
Basic error limit thermoresistor ranges with SFU	-
Destruction limit resistance thermometer inputs	-
Thermocouple inputs	-
Thermocouple ranges	-
Operational limit of thermocouple ranges	-
Operational limit of thermocouple ranges with SFU	-
Basic error limit thermoelement ranges	-
Basic error limit thermoelement ranges with SFU	-
Destruction limit thermocouple inputs	-
Programmable temperature compensation	-
External temperature compensation	-
Internal temperature compensation	-
Temperature error internal compensation	-
Technical unit of temperature measurement	-
Resolution in bit	12
Measurement principle	successive approximation
Basic conversion time	1.15 ms all channels
Noise suppression for frequency	>80dB (UCM<20V)
Status information, alarms, diagnostics	
Status display	yes
Interrupts	yes, parameterizable
Process alarm	yes, parameterizable
Diagnostic interrupt	yes, parameterizable
Diagnostic functions	yes
Diagnostics information read-out	possible
Module state	green LED
Module error display	red LED
Channel error display	red LED per channel
Isolation	
Between channels	✓

031-1BB10 - AI 2x12Bit 0(4)...20mA - ISO > Technical data

Order no.	031-1BB10
Between channels of groups to	1
Between channels and backplane bus	✓
Between channels and power supply	✓
Max. potential difference between circuits	DC 75 V/ AC 50 V
Max. potential difference between inputs (Ucm)	DC 75 V/ AC 50 V
Max. potential difference between Mana and Mintern (Uiso)	-
Max. potential difference between inputs and Mana (Ucm)	DC 75 V/ AC 50 V
Max. potential difference between inputs and Mintern (Uiso)	DC 75 V/ AC 50 V
Max. potential difference between Mintern and outputs	-
Insulation tested with	DC 500 V
Technical data encoder supply	
Number of outputs	2
Output voltage (typ)	+24 V (-1.5 V)
Output voltage (rated value)	35 mA
Short-circuit protection	yes, electronic
Binding of potential	corresponding analog input
Datasizes	
Input bytes	4
Output bytes	0
Parameter bytes	20
Diagnostic bytes	20
Housing	
Material	PPE / PPE GF10
Mounting	Profile rail 35 mm
Mechanical data	
Dimensions (WxHxD)	12.9 mm x 109 mm x 76.5 mm
Net weight	65 g
Weight including accessories	65 g
Gross weight	79 g
Environmental conditions	
Operating temperature	0 °C to 60 °C
Storage temperature	-25 °C to 70 °C
Certifications	
UL certification	yes
KC certification	yes

SFU - Interference frequency suppression

3.4.2 Parameter data

DS - Record set for access via CPU, PROFIBUS and PROFINET

IX - Index for access via CANopen

SX - Subindex for access via EtherCAT with Index 3100h + EtherCAT-Slot

More can be found in the according manual of your bus coupler.

Name	Bytes	Function	Default	DS	IX	SX
DIAG_EN	1	Diagnostics*	00h	00h	3100h	01h
SHORT_EN	1	Monitoring of sensor voltage*	00h	00h	3101h	02h
LIMIT_EN	1	Limit value monitoring*	00h	00h	3102h	03h
RES	1	reserved*	00h	00h	3103h	04h
CH0FN	1	Function number channel 0	31h	80h	3104h	05h
CH0FO	1	Function option channel 0	00h	80h	3105h	06h
CH0UL	2	Upper limit value channel 0	7FFFh	80h	3106h...3107h	07h
CH0LL	2	Lower limit value channel 0	8000h	80h	3108h...3109h	08h
CH1FN	1	Function number channel 1	31h	81h	310Ah	09h
CH1FO	1	Function option channel 1	00h	81h	310Bh	0Ah
CH1UL	2	Upper limit value channel 1	7FFFh	81h	310Ch...310Dh	0Bh
CH1LL	2	Lower limit value channel 1	8000h	81h	310Eh...310Fh	0Ch

* This record set may only be transferred at STOP state.

DIAG_EN Diagnostic interrupt

Byte	Bit 7 ... 0
0	<ul style="list-style-type: none"> ■ Diagnostic interrupt <ul style="list-style-type: none"> – 00h: disabled – 40h: enabled

■ Here you can enable respectively disable the diagnostic interrupt.

SHORT_EN Monitoring sensor voltage

Byte	Bit 7 ... 0
0	<ul style="list-style-type: none"> ■ Bit 0: Monitoring of sensor voltage channel 0 (1: on) ■ Bit 1: Monitoring of sensor voltage channel 1 (1: on) ■ Bit 7 ... 2: reserved

LIMIT_EN Limit value monitoring

Byte	Bit 7 ... 0
0	<ul style="list-style-type: none"> ■ Bit 0: Limit value monitoring channel 0 (1: on) ■ Bit 1: Limit value monitoring channel 1 (1: on) ■ Bit 7 ... 2: reserved

CHxFN Function number channel x

In the following there are the measuring ranges with corresponding function number listed, which were supported by the analog module. With FFh the corresponding channel is disabled and disabled the respective sensor supply. The formulas listed here allow you to transform an evaluated measuring value (digital value) to a value assigned to the measuring range (analog value) and vice versa.

0(4) ... 20mA

Meas. range (funct. no.)	Current (I)	Decimal (D)	Hex	Range	Formulas
0 ... 20mA Siemens S7 format (31h)	23.52mA	32511	7EFFh	overrange	$D = 27648 \cdot \frac{I}{20}$ $I = D \cdot \frac{20}{27648}$
	20mA	27648	6C00h	nominal range	
	10mA	13824	3600h		
	0mA	0	0000h		
	-3.52mA	-4864	ED00h	underrange	
0 ... 20mA Siemens S5 format (41h)	25.00mA	20480	5000h	overrange	$D = 16384 \cdot \frac{I}{20}$ $I = D \cdot \frac{20}{16384}$
	20mA	16384	4000h	nominal range	
	10mA	8192	2000h		
	0mA	0	0000h		
	-4,00mA	-3277	F333h	underrange	
4 ... 20mA Siemens S7 format (30h)	22.81mA	32511	7EFFh	overrange	$D = 27648 \cdot \frac{I-4}{16}$ $I = D \cdot \frac{16}{27648} + 4$
	20mA	27648	6C00h	nominal range	
	12mA	13824	3600h		
	4mA	0	0000h		
	1.19mA	-4864	ED00h	underrange	
4 ... 20mA Siemens S5 format (40h)	24.00mA	20480	5000h	overrange	$D = 16384 \cdot \frac{I-4}{16}$ $I = D \cdot \frac{16}{16384} + 4$
	20mA	16384	4000h	nominal range	
	12mA	8192	2000h		
	4mA	0	0000h		
	0.8mA	-3277	F333h	underrange	

0 ... 20mA / 4KM format

Meas. range (funct. no.)	Current (I)	Decimal (D)	Hex	Range	Formulas
0 ... 20mA 4KM format (3Fh)	20.457mA	4095	0FFFh	overrange	$D = 4000 \cdot \frac{I}{20}$ $I = D \cdot \frac{20}{4000}$
	20mA	4000	0FA0h	nominal range	
	10mA	2000	07D0h		
	0mA	0	0000h		

CHxFO Function option channel x

As function option for each channel a time constant x10ms may be preset for a low-pass filter. This is a second-order Butterworth filter. Here frequencies, which lie above the critical frequency, can be filtered. The setting for interference suppression (SFU) of 50Hz respectively 60Hz is 200ms respectively 170ms.

Range of values: 0 ... 250 (0 = deactivated)

The following diagram shows the transient behavior of the filter with a time constant of 500ms. Here the filter reaches the desired value after 1700ms for the first time.

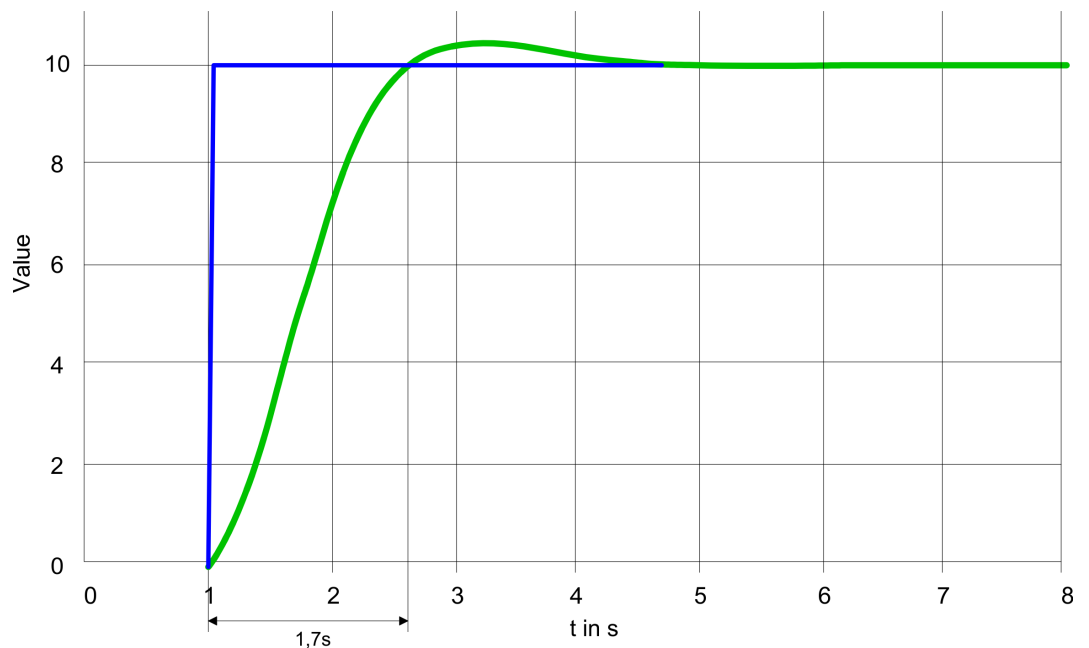

CHxUL CHxLL Upper limit value Lower limit value channel x

For each channel an *upper* and a *lower limit* may be defined. Here only values of the nominal range may be preset, otherwise you receive a parameterization error. By presetting 7FFFh for the upper respectively 8000h for the lower limit value the corresponding limit is deactivated. As soon as the measuring value is beyond the limits and the limit value monitoring is activated, a process interrupt is initialized.

3.4.3 Diagnostics and interrupt

Event	Process interrupt	Diagnostics interrupt	parameterizable
Error in project engineering / parameterization	-	X	-
Measuring range overflow	-	X	-
Measuring range underflow	-	X	-
Limit overflow	X	-	X
Limit underflow	X	-	X
diagnostics buffer overflow	-	X	-
Process interrupt lost	-	X	-
Sensor voltage monitoring	-	X	-

Process interrupt

So you may react to asynchronous events, there is the possibility to activate a process interrupt. A process interrupt interrupts the linear program sequence and jumps depending on the master system to a corresponding Interrupt routine. Here you can react to the process interrupt accordingly.

With CANopen the process interrupt data a transferred via an emergency telegram.

Operating with CPU, PROFIBUS and PROFINET the process interrupt data were transferred via diagnostics telegram.

SX - Subindex for access via EtherCAT with Index 5000h

More can be found in the according manual of your bus coupler.

Name	Bytes	Function	Default	SX
PRIT_OL	1	Upper limit overflow channel x	00h	02h
PRIT_UL	1	Lower limit underflow channel x	00h	03h
PRIT_US	2	µs-Ticker	00h	04h (high byte) 05h (low byte)

PRIT_OL upper limit overflow

Byte	Bit 7 ... 0
0	<ul style="list-style-type: none"> ■ Bit 0: Upper limit overflow channel 0 ■ Bit 1: Upper limit overflow channel 1 ■ Bit 7 ... 2: reserved

PRIT_UL Limit underflow

Byte	Bit 7 ... 0
0	<ul style="list-style-type: none"> ■ Bit 0: Lower limit underflow channel 0 ■ Bit 1: Lower limit underflow channel 1 ■ Bit 7 ... 2: reserved

PRIT_US μ s-Ticker

Byte	Bit 7 ... 0
0...1	16bit μ s value at the moment of the interrupt

 μ s ticker

In the SLIO module there is a 32 bit timer (μ s ticker). With PowerON the timer starts counting with 0. After $2^{32}-1\mu$ s the timer starts with 0 again. PRIT_US represents the lower 2 byte of the μ s ticker value (0 ... $2^{16}-1$).

Diagnostic data

Via the parameterization you may activate a diagnostic interrupt for the module. With a diagnostics interrupt the module serves for diagnostics data for diagnostic interrupt_{incoming}. As soon as the reason for releasing a diagnostic interrupt is no longer present, the diagnostic interrupt_{going} automatically takes place. All events of a channel between diagnostic interrupt_{incoming} and diagnostic interrupt_{going} are not stored and get lost. Within this time window (1. diagnostic interrupt_{incoming} until last diagnostic interrupt_{going}) the MF-LED of the module is on.

DS - Record set for access via CPU, PROFIBUS and PROFINET. The access happens by DS 01h. Additionally the first 4 bytes may be accessed by DS 00h.

IX - Index for access via CANopen. The access happens by IX 2F01h. Additionally the first 4 bytes may be accessed by IX 2F00h.

SX - Subindex for access via EtherCAT with Index 5005h.

More can be found in the according manual of your bus coupler.

Name	Bytes	Function	Default	DS	IX	SX	
ERR_A	1	Diagnostic	00h	01h	2F01h	02h	
MODTYP	1	Module information	15h			03h	
RES2	1	reserved	00h			04h	
ERR_D	1	Diagnostic	00h			05h	
CHTYP	1	Channel type	71h			06h	
NUMBIT	1	Number diagnostic bits per channel	08h			07h	
NUMCH	1	Number of channels of a module	02h			08h	
CHERR	1	Channel error	00h			09h	
CH0ERR	1	Channel-specific error channel 0	00h			0Ah	
CH1ERR	1	Channel-specific error channel 1	00h			0Bh	
CH2ERR... CH7ERR	6	reserved	00h			0Ch ... 11h	
DIAG_US	4	μ s ticker	00h				13h

ERR_A Diagnostic

Byte	Bit 7 ... 0
0	<ul style="list-style-type: none"> ■ Bit 0: set at module failure ■ Bit 1: set at internal error ■ Bit 2: set at external error ■ Bit 3: set at channel error ■ Bit 4: set at external auxiliary supply missing ■ Bit 6 ... 5: reserved ■ Bit 7: set at error in parameterization

MODTYP Module information

Byte	Bit 7 ... 0
0	<ul style="list-style-type: none"> ■ Bit 3 ... 0: module class <ul style="list-style-type: none"> – 0101b analog module ■ Bit 4: set at channel information present ■ Bit 7 ... 5: reserved

ERR_D Diagnostic

Byte	Bit 7 ... 0
0	<ul style="list-style-type: none"> ■ Bit 2 ... 0: reserved ■ Bit 3: set at internal diagnostics buffer overflow ■ Bit 4: set at internal communication error ■ Bit 5: reserved ■ Bit 6: set at process interrupt lost ■ Bit 7: reserved

CHTYP Channel type

Byte	Bit 7 ... 0
0	<ul style="list-style-type: none"> ■ Bit 6 ... 0: Channel type <ul style="list-style-type: none"> – 70h: Digital input – 71h: Analog input – 72h: Digital output – 73h: Analog output – 74h: Analog input/-output – 76h: Counter ■ Bit 7: reserved

NUMBIT Diagnostic bits

Byte	Bit 7 ... 0
0	Number of diagnostic bits per channel (here 08h)

NUMCH Channels

Byte	Bit 7 ... 0
0	Number of channels of a module (here 02h)

CHERR Channel error

Byte	Bit 7 ... 0
0	<ul style="list-style-type: none"> ■ Bit 0: set at error in channel group 0 ■ Bit 1: set at error in channel group 1 ■ Bit 7 ... 2: reserved

**CH0ERR / CH1ERR
Channel-specific**

Byte	Bit 7 ... 0
0	Channel-specific error: Channel x: <ul style="list-style-type: none"> ■ Bit 0: set at project engineering/parameterization error ■ Bit 1: raw value above the permissible range ■ Bit 2: raw value below the acceptable range ■ Bit 3: reserved ■ Bit 4: error sensor supply voltage ■ Bit 5: set at process interrupt lost ■ Bit 6: set at measuring range underflow ■ Bit 7: set at measuring range overflow

**CH2ERR ... CH7ERR
reserved**

Byte	Bit 7 ... 0
0	reserved

DIAG_US μ s ticker

Byte	Bit 7 ... 0
0...3	Value of the μ s ticker at the moment of the diagnostic

 μ s ticker

In the System SLIO module there is a timer (μ s ticker). With PowerON the timer starts counting with 0. After $2^{32}-1\mu$ s the timer starts with 0 again.

3.5 031-1BB30 - AI 2x12Bit 0...10V

Properties

The electronic module has 2 inputs with parameterizable functions. The channels of the module are electrically isolated from the backplane bus. In addition, the channels are isolated to the DC 24V power supply by means of DC/DC converter.

- 2 analog inputs
- Suited for sensors with 0 ... 10V
- Diagnostics function
- 12bit resolution

Structure

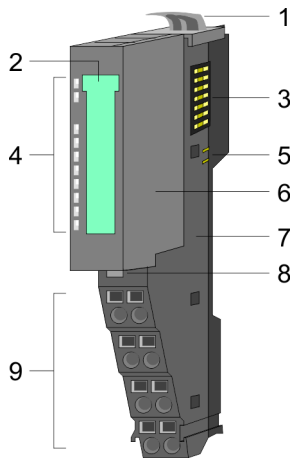

- 1 Locking lever terminal module
- 2 Labeling strip
- 3 Backplane bus
- 4 LED status indication
- 5 DC 24V power section supply
- 6 Electronic module
- 7 Terminal module
- 8 Locking lever electronic module
- 9 Terminal

Status indication

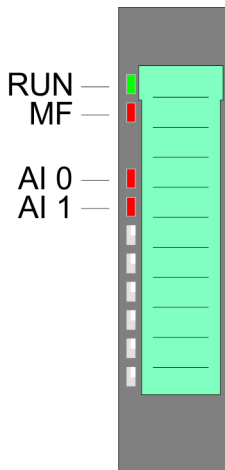

RUN	MF	AI x	Description
<input checked="" type="checkbox"/> green	<input checked="" type="checkbox"/> red	<input checked="" type="checkbox"/> red	
<input checked="" type="checkbox"/>	<input type="checkbox"/>	X	Bus communication is OK Module status is OK
<input checked="" type="checkbox"/>	<input checked="" type="checkbox"/>	X	Bus communication is OK Module status reports an error
<input type="checkbox"/>	<input checked="" type="checkbox"/>	X	Bus communication is not possible Module status reports an error
<input type="checkbox"/>	<input type="checkbox"/>	X	Error at bus power supply
X	<input checked="" type="checkbox"/> 2Hz	X	Error in configuration ↗ <i>Chap. 2.8 'Trouble shooting - LEDs' page 30</i>
<input checked="" type="checkbox"/>	<input type="checkbox"/>	<input checked="" type="checkbox"/>	Error channel x <ul style="list-style-type: none"> ■ Signal leaves measuring range ■ Error in parameterization
not relevant: X			

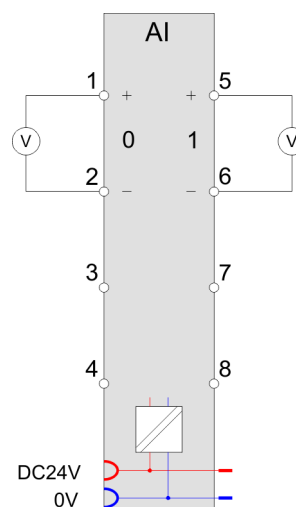
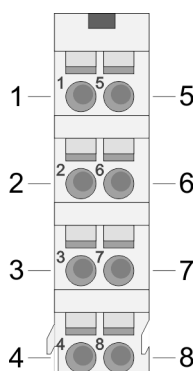
Pin assignmentFor wires with a cross section of 0.08mm² up to 1.5mm².

Pos.	Function	Type	Description
1	+AI 0	I	+ Channel 0
2	-AI 0	I	Ground Channel 0
3	---	---	not connected
4	---	---	not connected
5	+AI 1	I	+ Channel 1
6	-AI 1	I	Ground Channel 1
7	---	---	not connected
8	---	---	not connected

I: Input

In-/Output area

At CPU, PROFIBUS and PROFINET the input respectively output area is embedded to the corresponding address area.

IX - Index for access via CANopen with s = Subindex, depends on number and type of analog modules

SX - Subindex for access via EtherCAT with Index 6000h + EtherCAT-Slot

More can be found in the according manual of your bus coupler.

Input area

Addr.	Name	Bytes	Function	IX	SX
+0	AI 0	2	Analog value channel 0	6401h/s	01h
+2	AI 1	2	Analog value channel 1	6401h/s+1	02h

Output area

No byte of the output area is used by the module.

3.5.1 Technical data

Order no.	031-1BB30
Type	SM 031
Module ID	0401 15C3
Current consumption/power loss	
Current consumption from backplane bus	80 mA
Power loss	0.7 W
Technical data analog inputs	
Number of inputs	2
Cable length, shielded	200 m
Rated load voltage	DC 24 V
Current consumption from load voltage L+ (without load)	15 mA
Voltage inputs	✓
Min. input resistance (voltage range)	100 kΩ
Input voltage ranges	0 V ... +10 V
Operational limit of voltage ranges	+/-0.3%
Operational limit of voltage ranges with SFU	-
Basic error limit voltage ranges	+/-0.2%
Basic error limit voltage ranges with SFU	-
Destruction limit voltage	max. 30V
Current inputs	-
Max. input resistance (current range)	-
Input current ranges	-
Operational limit of current ranges	-
Operational limit of current ranges with SFU	-
Basic error limit current ranges	-
Radical error limit current ranges with SFU	-
Destruction limit current inputs (voltage)	-
Destruction limit current inputs (electrical current)	-
Resistance inputs	-
Resistance ranges	-
Operational limit of resistor ranges	-
Operational limit of resistor ranges with SFU	-
Basic error limit	-
Basic error limit with SFU	-
Destruction limit resistance inputs	-
Resistance thermometer inputs	-

Order no.	031-1BB30
Resistance thermometer ranges	-
Operational limit of resistance thermometer ranges	-
Operational limit of resistance thermometer ranges with SFU	-
Basic error limit thermoresistor ranges	-
Basic error limit thermoresistor ranges with SFU	-
Destruction limit resistance thermometer inputs	-
Thermocouple inputs	-
Thermocouple ranges	-
Operational limit of thermocouple ranges	-
Operational limit of thermocouple ranges with SFU	-
Basic error limit thermoelement ranges	-
Basic error limit thermoelement ranges with SFU	-
Destruction limit thermocouple inputs	-
Programmable temperature compensation	-
External temperature compensation	-
Internal temperature compensation	-
Temperature error internal compensation	-
Technical unit of temperature measurement	-
Resolution in bit	12
Measurement principle	successive approximation
Basic conversion time	2 ms all channels
Noise suppression for frequency	>50dB at 50Hz (UCM<2V)
Status information, alarms, diagnostics	
Status display	yes
Interrupts	no
Process alarm	no
Diagnostic interrupt	no
Diagnostic functions	yes
Diagnostics information read-out	possible
Module state	green LED
Module error display	red LED
Channel error display	red LED per channel
Isolation	
Between channels	-
Between channels of groups to	-

031-1BB30 - AI 2x12Bit 0...10V > Technical data

Order no.	031-1BB30
Between channels and backplane bus	✓
Between channels and power supply	✓
Max. potential difference between circuits	-
Max. potential difference between inputs (Ucm)	DC 2 V
Max. potential difference between Mana and Mintern (Uiso)	-
Max. potential difference between inputs and Mana (Ucm)	-
Max. potential difference between inputs and Mintern (Uiso)	DC 75 V/ AC 50 V
Max. potential difference between Mintern and outputs	-
Insulation tested with	DC 500 V
Datasizes	
Input bytes	4
Output bytes	0
Parameter bytes	6
Diagnostic bytes	20
Housing	
Material	PPE / PPE GF10
Mounting	Profile rail 35 mm
Mechanical data	
Dimensions (WxHxD)	12.9 mm x 109 mm x 76.5 mm
Net weight	59 g
Weight including accessories	59 g
Gross weight	74 g
Environmental conditions	
Operating temperature	0 °C to 60 °C
Storage temperature	-25 °C to 70 °C
Certifications	
UL certification	yes
KC certification	yes

SFU - Interference frequency suppression

3.5.2 Parameter data

DS - Record set for access via CPU, PROFIBUS and PROFINET

IX - Index for access via CANopen

SX - Subindex for access via EtherCAT with Index 3100h + EtherCAT-Slot

More can be found in the according manual of your bus coupler.

Name	Bytes	Function	Default	DS	IX	SX
CH0FN	1	Function number channel 0	10h	80h	3100h	01h
CH1FN	1	Function number channel 1	10h	81h	3101h	02h

CHxFN Function number channel x

In the following there are the measuring ranges with function number listed, which were supported by the analog module. With FFh the corresponding channel is deactivated. The formulas listed here allow you to transform an evaluated measuring value (digital value) to a value assigned to the measuring range (analog value) and vice versa.

0 ... 10V

Meas. range (funct. no.)	Voltage (U)	Decimal (D)	Hex	Range	Formulas
0 ... 10V Siemens S7 format (10h)	11.76V	32511	7EFFh	overrange	$D = 27648 \cdot \frac{U}{10}$ $U = D \cdot \frac{10}{27648}$
	10V	27648	6C00h	nominal range	
	5V	13824	3600h		
	0V	0	0000h		
	-1.76V	-4864	ED00h	underrange	
0 ... 10V Siemens S5 format (20h)	12.5V	20480	5000h	overrange	$D = 16384 \cdot \frac{U}{10}$ $U = D \cdot \frac{10}{16384}$
	10V	16384	4000h	nominal range	
	5V	8192	2000h		
	0V	0	0000h		
	-2V	-3277	F333h	underrange	

3.5.3 Diagnostic data

This module does not support diagnostic interrupt functions, the diagnostics data serve for information about this module. On error the corresponding channel LED of the module is activated and the error is registered in the diagnostics data.

The following errors are listed in the diagnostics data:

- Error in project engineering / parameterization
- Measuring range overflow
- Measuring range underflow

031-1BB30 - AI 2x12Bit 0...10V > Diagnostic data

DS - Record set for access via CPU, PROFIBUS and PROFINET. The access happens by DS 01h. Additionally the first 4 bytes may be accessed by DS 00h.

IX - Index for access via CANopen. The access happens by IX 2F01h. Additionally the first 4 bytes may be accessed by IX 2F00h.

SX - Subindex for access via EtherCAT with Index 5005h.

More can be found in the according manual of your bus coupler.

Name	Bytes	Function	Default	DS	IX	SX
ERR_A	1	Diagnostic	00h	01h	2F01h	02h
MODTYP	1	Module information	15h			03h
ERR_C	1	reserved	00h			04h
ERR_D	1	Diagnostic	00h			05h
CHTYP	1	Channel type	71h			06h
NUMBIT	1	Number diagnostic bits per channel	08h			07h
NUMCH	1	Number of channels of a module	02h			08h
CHERR	1	Channel error	00h			09h
CH0ERR	1	Channel-specific error channel 0	00h			0Ah
CH1ERR	1	Channel-specific error channel 1	00h			0Bh
CH2ERR... CH7ERR	6	reserved	00h			0Ch ... 11h
DIAG_US	4	µs ticker	00h			13h

ERR_A Diagnostic

Byte	Bit 7 ... 0
0	<ul style="list-style-type: none"> ■ Bit 0: set at module failure ■ Bit 1: set at internal error ■ Bit 2: set at external error ■ Bit 3: set at channel error ■ Bit 4: set at external auxiliary supply missing ■ Bit 6 ... 5: reserved ■ Bit 7: set at error in parameterization

MODTYP Module information

Byte	Bit 7 ... 0
0	<ul style="list-style-type: none"> ■ Bit 3 ... 0: module class <ul style="list-style-type: none"> – 0101b analog module ■ Bit 4: set at channel information present ■ Bit 7 ... 5: reserved

ERR_D Diagnostic

Byte	Bit 7 ... 0
0	<ul style="list-style-type: none"> ■ Bit 2 ... 0: reserved ■ Bit 3: set at internal diagnostics buffer overflow ■ Bit 4: set at internal communication error ■ Bit 7 ... 5: reserved

CHTYP Channel type

Byte	Bit 7 ... 0
0	<ul style="list-style-type: none"> ■ Bit 6 ... 0: Channel type <ul style="list-style-type: none"> – 70h: Digital input – 71h: Analog input – 72h: Digital output – 73h: Analog output – 74h: Analog input/-output – 76h: Counter ■ Bit 7: reserved

NUMBIT Diagnostic bits

Byte	Bit 7 ... 0
0	Number of diagnostic bits per channel (here 08h)

NUMCH Channels

Byte	Bit 7 ... 0
0	Number of channels of a module (here 02h)

CHERR Channel error

Byte	Bit 7 ... 0
0	<ul style="list-style-type: none"> ■ Bit 0: set at error in channel group 0 ■ Bit 1: set at error in channel group 1 ■ Bit 7 ... 2: reserved

**CH0ERR / CH1ERR
Channel-specific**

Byte	Bit 7 ... 0
0	Channel-specific error channel x: <ul style="list-style-type: none"> ■ Bit 0: set at configuring/parameter assignment error ■ Bit 5 ... 1: reserved ■ Bit 6: set at measuring range underflow ■ Bit 7: set at measuring range overflow

**CH2ERR ... CH7ERR
reserved**

Byte	Bit 7 ... 0
0	reserved

031-1BB30 - AI 2x12Bit 0...10V > Diagnostic data

DIAG_US μ s ticker

Byte	Bit 7 ... 0
0...3	Value of the μ s ticker at the moment of the diagnostic

 μ s ticker

In the System SLIO module there is a timer (μ s ticker). With PowerON the timer starts counting with 0. After $2^{32}-1\mu$ s the timer starts with 0 again.

3.6 031-1BB40 - AI 2x12Bit 0(4)...20mA

Properties

The electronic module has 2 inputs with parameterizable functions. The channels of the module are electrically isolated from the backplane bus. In addition, the channels are isolated to the DC 24V power supply by means of DC/DC converter.

- 2 analog inputs
- Suited for sensors with 0 ... 20mA;
4 ... 20mA with external supply
- Diagnostics function
- 12bit resolution

Structure

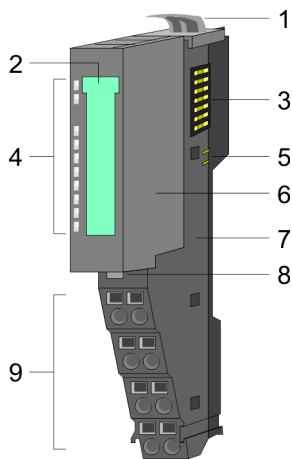

- 1 Locking lever terminal module
- 2 Labeling strip
- 3 Backplane bus
- 4 LED status indication
- 5 DC 24V power section supply
- 6 Electronic module
- 7 Terminal module
- 8 Locking lever electronic module
- 9 Terminal

Status indication

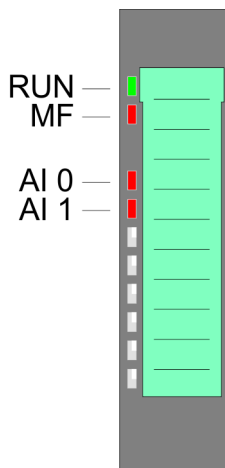

RUN	MF	AI x	Description
■ green	■ red	■ red	
■	<input type="checkbox"/>	X	Bus communication is OK Module status is OK
■	■	X	Bus communication is OK Module status reports an error
<input type="checkbox"/>	■	X	Bus communication is not possible Module status reports an error
<input type="checkbox"/>	<input type="checkbox"/>	X	Error at bus power supply
X	▣ 2Hz	X	Error in configuration Chap. 2.8 'Trouble shooting - LEDs' page 30
■	<input type="checkbox"/>	■	Error channel x <ul style="list-style-type: none"> ■ Signal leaves measuring range ■ Error in parameterization
not relevant: X			

Pin assignment

For wires with a cross section of 0.08mm² up to 1.5mm².

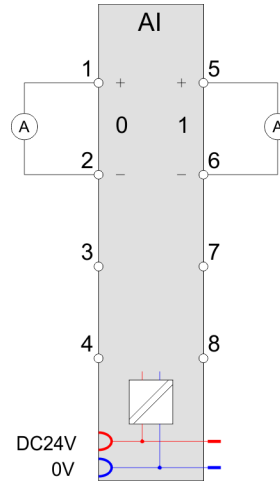
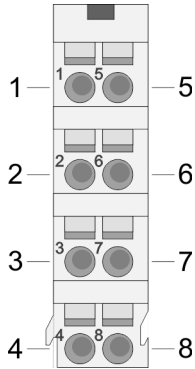

Pos.	Function	Type	Description
1	+AI 0	I	+ Channel 0
2	-AI 0	I	Ground Channel 0
3	---	---	not connected
4	---	---	not connected
5	+AI 1	I	+ Channel 1
6	-AI 1	I	Ground Channel 1
7	---	---	not connected
8	---	---	not connected

I: Input



If a 2wire measuring transducer is used, you have to connect in line an external power supply.

In-/Output area

At CPU, PROFIBUS and PROFINET the input respectively output area is embedded to the corresponding address area.

IX - Index for access via CANopen with s = Subindex, depends on number and type of analog modules

SX - Subindex for access via EtherCAT with Index 6000h + EtherCAT-Slot

More can be found in the according manual of your bus coupler.

Input area

Addr.	Name	Bytes	Function	IX	SX
+0	AI 0	2	Analog value channel 0	6401h/s	01h
+2	AI 1	2	Analog value channel 1	6401h/s+1	02h

Output area No byte of the output area is used by the module.

3.6.1 Technical data

Order no.	031-1BB40
Type	SM 031
Module ID	0402 15C3
Current consumption/power loss	
Current consumption from backplane bus	80 mA
Power loss	0.7 W
Technical data analog inputs	
Number of inputs	2
Cable length, shielded	200 m
Rated load voltage	DC 24 V
Current consumption from load voltage L+ (without load)	15 mA
Voltage inputs	-
Min. input resistance (voltage range)	-
Input voltage ranges	-
Operational limit of voltage ranges	-
Operational limit of voltage ranges with SFU	-
Basic error limit voltage ranges	-
Basic error limit voltage ranges with SFU	-
Destruction limit voltage	-
Current inputs	✓
Max. input resistance (current range)	110 Ω
Input current ranges	0 mA ... +20 mA +4 mA ... +20 mA
Operational limit of current ranges	+/-0.3% ... +/-0.5%
Operational limit of current ranges with SFU	-
Basic error limit current ranges	+/-0.2% ... +/-0.3%
Radical error limit current ranges with SFU	-
Destruction limit current inputs (voltage)	max. 24V
Destruction limit current inputs (electrical current)	max. 40mA
Resistance inputs	-
Resistance ranges	-
Operational limit of resistor ranges	-
Operational limit of resistor ranges with SFU	-
Basic error limit	-

031-1BB40 - AI 2x12Bit 0(4)...20mA > Technical data

Order no.	031-1BB40
Basic error limit with SFU	-
Destruction limit resistance inputs	-
Resistance thermometer inputs	-
Resistance thermometer ranges	-
Operational limit of resistance thermometer ranges	-
Operational limit of resistance thermometer ranges with SFU	-
Basic error limit thermoresistor ranges	-
Basic error limit thermoresistor ranges with SFU	-
Destruction limit resistance thermometer inputs	-
Thermocouple inputs	-
Thermocouple ranges	-
Operational limit of thermocouple ranges	-
Operational limit of thermocouple ranges with SFU	-
Basic error limit thermoelement ranges	-
Basic error limit thermoelement ranges with SFU	-
Destruction limit thermocouple inputs	-
Programmable temperature compensation	-
External temperature compensation	-
Internal temperature compensation	-
Temperature error internal compensation	-
Technical unit of temperature measurement	-
Resolution in bit	12
Measurement principle	successive approximation
Basic conversion time	2 ms all channels
Noise suppression for frequency	>50dB at 50Hz (UCM<2V)
Status information, alarms, diagnostics	
Status display	yes
Interrupts	no
Process alarm	no
Diagnostic interrupt	no
Diagnostic functions	yes
Diagnostics information read-out	possible
Module state	green LED
Module error display	red LED
Channel error display	red LED per channel

Order no.	031-1BB40
Isolation	
Between channels	-
Between channels of groups to	-
Between channels and backplane bus	✓
Between channels and power supply	✓
Max. potential difference between circuits	-
Max. potential difference between inputs (Ucm)	DC 2 V
Max. potential difference between Mana and Mintern (Uiso)	-
Max. potential difference between inputs and Mana (Ucm)	-
Max. potential difference between inputs and Mintern (Uiso)	DC 75 V/ AC 50 V
Max. potential difference between Mintern and outputs	-
Insulation tested with	DC 500 V
Datasizes	
Input bytes	4
Output bytes	0
Parameter bytes	6
Diagnostic bytes	20
Housing	
Material	PPE / PPE GF10
Mounting	Profile rail 35 mm
Mechanical data	
Dimensions (WxHxD)	12.9 mm x 109 mm x 76.5 mm
Net weight	59 g
Weight including accessories	59 g
Gross weight	74 g
Environmental conditions	
Operating temperature	0 °C to 60 °C
Storage temperature	-25 °C to 70 °C
Certifications	
UL certification	yes
KC certification	yes

SFU - Interference frequency suppression

3.6.2 Parameter data

DS - Record set for access via CPU, PROFIBUS and PROFINET

IX - Index for access via CANopen

SX - Subindex for access via EtherCAT with Index 3100h + EtherCAT-Slot

More can be found in the according manual of your bus coupler.

Name	Bytes	Function	Default	DS	IX	SX
CH0FN	1	Function number channel 0	31h	80h	3100h	01h
CH1FN	1	Function number channel 1	31h	81h	3101h	02h

CHxFN Function number channel x

In the following there are the measuring ranges with corresponding function number listed, which were supported by the analog module. With FFh the corresponding channel is deactivated. The formulas listed here allow you to transform an evaluated measuring value (digital value) to a value assigned to the measuring range (analog value) and vice versa.

0(4) ... 20mA

Meas. range (funct. no.)	Current (I)	Decimal (D)	Hex	Range	Formulas
0 ... 20mA Siemens S7 format (31h)	23.52mA	32511	7EFFh	overrange	$D = 27648 \cdot \frac{I}{20}$ $I = D \cdot \frac{20}{27648}$
	20mA	27648	6C00h	nominal range	
	10mA	13824	3600h		
	0mA	0	0000h		
	-3.52mA	-4864	ED00h	underrange	
0 ... 20mA Siemens S5 format (41h)	25.00mA	20480	5000h	overrange	$D = 16384 \cdot \frac{I}{20}$ $I = D \cdot \frac{20}{16384}$
	20mA	16384	4000h	nominal range	
	10mA	8192	2000h		
	0mA	0	0000h		
	-4,00mA	-3277	F333h	underrange	
4 ... 20mA Siemens S7 format (30h)	22.81mA	32511	7EFFh	overrange	$D = 27648 \cdot \frac{I-4}{16}$ $I = D \cdot \frac{16}{27648} + 4$
	20mA	27648	6C00h	nominal range	
	12mA	13824	3600h		
	4mA	0	0000h		
	1.19mA	-4864	ED00h	underrange	
4 ... 20mA Siemens S5 format (40h)	24.00mA	20480	5000h	overrange	$D = 16384 \cdot \frac{I-4}{16}$ $I = D \cdot \frac{16}{16384} + 4$
	20mA	16384	4000h	nominal range	
	12mA	8192	2000h		
	4mA	0	0000h		
	0.8mA	-3277	F333h	underrange	

3.6.3 Diagnostic data

So this module does not support diagnostic interrupt functions, the diagnostics data serve for information about this module. On error the corresponding channel LED of the module is activated and the error is registered in the diagnostics data.

The following errors are listed in the diagnostics data:

- Error in project engineering / parameterization
- Measuring range overflow
- Measuring range underflow

DS - Record set for access via CPU, PROFIBUS and PROFINET. The access happens by DS 01h. Additionally the first 4 bytes may be accessed by DS 00h.

IX - Index for access via CANopen. The access happens by IX 2F01h. Additionally the first 4 bytes may be accessed by IX 2F00h.

SX - Subindex for access via EtherCAT with Index 5005h.

More can be found in the according manual of your bus coupler.

Name	Bytes	Function	Default	DS	IX	SX
ERR_A	1	Diagnostic	00h	01h	2F01h	02h
MODTYP	1	Module information	15h			03h
ERR_C	1	reserved	00h			04h
ERR_D	1	Diagnostic	00h			05h
CHTYP	1	Channel type	71h			06h
NUMBIT	1	Number diagnostic bits per channel	08h			07h
NUMCH	1	Number of channels of a module	02h			08h
CHERR	1	Channel error	00h			09h
CH0ERR	1	Channel-specific error channel 0	00h			0Ah
CH1ERR	1	Channel-specific error channel 1	00h			0Bh
CH2ERR... CH7ERR	6	reserved	00h			0Ch ... 11h
DIAG_US	4	µs ticker	00h			13h

031-1BB40 - AI 2x12Bit 0(4)...20mA > Diagnostic data

ERR_A Diagnostic

Byte	Bit 7 ... 0
0	<ul style="list-style-type: none"> ■ Bit 0: set at module failure ■ Bit 1: set at internal error ■ Bit 2: set at external error ■ Bit 3: set at channel error ■ Bit 4: set at external auxiliary supply missing ■ Bit 6 ... 5: reserved ■ Bit 7: set at error in parameterization

MODTYP Module information

Byte	Bit 7 ... 0
0	<ul style="list-style-type: none"> ■ Bit 3 ... 0: module class <ul style="list-style-type: none"> – 0101b analog module ■ Bit 4: set at channel information present ■ Bit 7 ... 5: reserved

ERR_D Diagnostic

Byte	Bit 7 ... 0
0	<ul style="list-style-type: none"> ■ Bit 2 ... 0: reserved ■ Bit 3: set at internal diagnostics buffer overflow ■ Bit 4: set at internal communication error ■ Bit 7 ... 5: reserved

CHTYP Channel type

Byte	Bit 7 ... 0
0	<ul style="list-style-type: none"> ■ Bit 6 ... 0: Channel type <ul style="list-style-type: none"> – 70h: Digital input – 71h: Analog input – 72h: Digital output – 73h: Analog output – 74h: Analog input/output – 76h: Counter ■ Bit 7: reserved

NUMBIT Diagnostic bits

Byte	Bit 7 ... 0
0	Number of diagnostic bits per channel (here 08h)

NUMCH Channels

Byte	Bit 7 ... 0
0	Number of channels of a module (here 02h)

CHERR Channel error

Byte	Bit 7 ... 0
0	<ul style="list-style-type: none"> ■ Bit 0: set at error in channel group 0 ■ Bit 1: set at error in channel group 1 ■ Bit 7 ... 2: reserved

CH0ERR / CH1ERR
Channel-specific

Byte	Bit 7 ... 0
0	Channel-specific error channel x: <ul style="list-style-type: none"> ■ Bit 0: set at configuring/parameter assignment error ■ Bit 5 ... 1: reserved ■ Bit 6: set at measuring range underflow ■ Bit 7: set at measuring range overflow

CH2ERR ... CH7ERR
reserved

Byte	Bit 7 ... 0
0	reserved

DIAG_US μ s ticker

Byte	Bit 7 ... 0
0...3	Value of the μ s ticker at the moment of the diagnostic

 μ s ticker

In the System SLIO module there is a timer (μ s ticker). With PowerON the timer starts counting with 0. After $2^{32}-1\mu$ s the timer starts with 0 again.

3.7 031-1BB60 - AI 2x12Bit 0(4)...20mA - Sensor

Properties

The electronic module has 2 inputs with parameterizable functions. The channels of the module are isolated to the backplane bus.

- 2 analog inputs
- Integrated sensor supply
- Suited for sensors with 0(4) ... 20mA with external supply
- Diagnostics function
- 12bit resolution

Structure

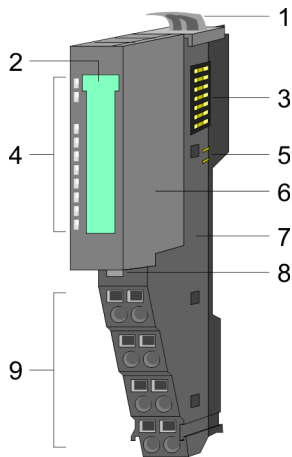

- 1 Locking lever terminal module
- 2 Labeling strip
- 3 Backplane bus
- 4 LED status indication
- 5 DC 24V power section supply
- 6 Electronic module
- 7 Terminal module
- 8 Locking lever electronic module
- 9 Terminal

Status indication

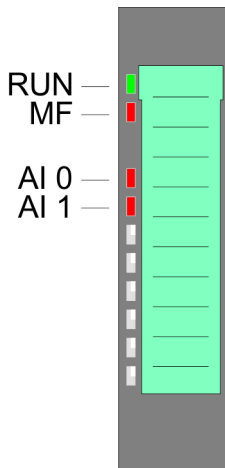

RUN	MF	AI x	Description
■ green	■ red	■ red	
■	<input type="checkbox"/>	X	Bus communication is OK Module status is OK
■	■	X	Bus communication is OK Module status reports an error
<input type="checkbox"/>	■	X	Bus communication is not possible Module status reports an error
<input type="checkbox"/>	<input type="checkbox"/>	X	Error at bus power supply
X	▣ 2Hz	X	Error in configuration ↗ <i>Chap. 2.8 'Trouble shooting - LEDs' page 30</i>
■	<input type="checkbox"/>	■	Error channel x <ul style="list-style-type: none"> ■ Signal leaves measuring range ■ Error in parameterization

not relevant: X



If the terminal module is not yet wired, when the module is power supplied the AI x LEDs get on due to the default parameterization 4 ... 20mA.

Pin assignment

For wires with a cross section of 0.08mm² up to 1.5mm².

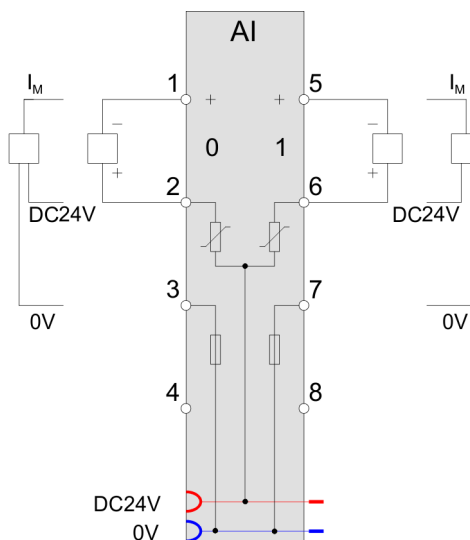
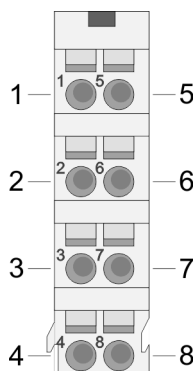

Pos.	Function	Type	Description
1	+AI 0	I	+ Channel 0
2	DC 24V	O	DC 24V for sensor Channel 0
3	0V	O	Ground for sensor (with 3 wire measurement)
4	---	---	not connected
5	+AI 0	I	+ Channel 0
6	DC 24V	O	DC 24V for sensor Channel 1
7	0V	O	Ground for sensor (with 3 wire measurement)
8	---	---	not connected

I: Input, O: Output

In-/Output area

At CPU, PROFIBUS and PROFINET the input respectively output area is embedded to the corresponding address area.

IX - Index for access via CANopen with s = Subindex, depends on number and type of analog modules

SX - Subindex for access via EtherCAT with Index 6000h + EtherCAT-Slot

More can be found in the according manual of your bus coupler.

Input area

Addr.	Name	Bytes	Function	IX	SX
+0	AI 0	2	Analog value channel 0	6401h/s	01h
+2	AI 1	2	Analog value channel 1	6401h/s+1	02h

Output area

No byte of the output area is used by the module.

3.7.1 Technical data

Order no.	031-1BB60
Type	SM 031
Module ID	0407 15C3
Current consumption/power loss	
Current consumption from backplane bus	50 mA
Power loss	0.7 W
Technical data analog inputs	
Number of inputs	2
Cable length, shielded	200 m
Rated load voltage	DC 24 V
Current consumption from load voltage L+ (without load)	15 mA
Voltage inputs	-
Min. input resistance (voltage range)	-
Input voltage ranges	-
Operational limit of voltage ranges	-
Operational limit of voltage ranges with SFU	-
Basic error limit voltage ranges	-
Basic error limit voltage ranges with SFU	-
Destruction limit voltage	-
Current inputs	✓
Max. input resistance (current range)	110 Ω
Input current ranges	0 mA ... +20 mA +4 mA ... +20 mA
Operational limit of current ranges	+/-0.5%
Operational limit of current ranges with SFU	-
Basic error limit current ranges	+/-0.3%
Radical error limit current ranges with SFU	-
Destruction limit current inputs (voltage)	max. 24V
Destruction limit current inputs (electrical current)	max. 40mA
Resistance inputs	-
Resistance ranges	-
Operational limit of resistor ranges	-
Operational limit of resistor ranges with SFU	-
Basic error limit	-
Basic error limit with SFU	-
Destruction limit resistance inputs	-

Order no.	031-1BB60
Resistance thermometer inputs	-
Resistance thermometer ranges	-
Operational limit of resistance thermometer ranges	-
Operational limit of resistance thermometer ranges with SFU	-
Basic error limit thermoresistor ranges	-
Basic error limit thermoresistor ranges with SFU	-
Destruction limit resistance thermometer inputs	-
Thermocouple inputs	-
Thermocouple ranges	-
Operational limit of thermocouple ranges	-
Operational limit of thermocouple ranges with SFU	-
Basic error limit thermoelement ranges	-
Basic error limit thermoelement ranges with SFU	-
Destruction limit thermocouple inputs	-
Programmable temperature compensation	-
External temperature compensation	-
Internal temperature compensation	-
Temperature error internal compensation	-
Technical unit of temperature measurement	-
Resolution in bit	12
Measurement principle	successive approximation
Basic conversion time	2 ms all channels
Noise suppression for frequency	>50dB at 50Hz (UCM<2V)
Status information, alarms, diagnostics	
Status display	yes
Interrupts	no
Process alarm	no
Diagnostic interrupt	no
Diagnostic functions	yes
Diagnostics information read-out	possible
Module state	green LED
Module error display	red LED
Channel error display	red LED per channel
Isolation	
Between channels	-

031-1BB60 - AI 2x12Bit 0(4)...20mA - Sensor > Technical data

Order no.	031-1BB60
Between channels of groups to	-
Between channels and backplane bus	✓
Between channels and power supply	-
Max. potential difference between circuits	-
Max. potential difference between inputs (U _{cm})	-
Max. potential difference between Mana and Mintern (U _{iso})	-
Max. potential difference between inputs and Mana (U _{cm})	-
Max. potential difference between inputs and Mintern (U _{iso})	DC 75 V/ AC 50 V
Max. potential difference between Mintern and outputs	-
Insulation tested with	DC 500 V
Technical data encoder supply	
Number of outputs	2
Output voltage (typ)	L+ (-250 mV)
Output voltage (rated value)	50 mA
Short-circuit protection	Multifuse 0.1 A
Binding of potential	Field voltage DC 24V
Datasizes	
Input bytes	4
Output bytes	0
Parameter bytes	6
Diagnostic bytes	20
Housing	
Material	PPE / PPE GF10
Mounting	Profile rail 35 mm
Mechanical data	
Dimensions (WxHxD)	12.9 mm x 109 mm x 76.5 mm
Net weight	58 g
Weight including accessories	58 g
Gross weight	72 g
Environmental conditions	
Operating temperature	0 °C to 60 °C
Storage temperature	-25 °C to 70 °C
Certifications	
UL certification	yes
KC certification	yes

SFU - Interference frequency suppression

3.7.2 Parameter data

DS - Record set for access via CPU, PROFIBUS and PROFINET

IX - Index for access via CANopen

SX - Subindex for access via EtherCAT with Index 3100h + EtherCAT-Slot

More can be found in the according manual of your bus coupler.

Name	Bytes	Function	Default	DS	IX	SX
CH0FN	1	Function number channel 0	30h	80h	3100h	01h
CH1FN	1	Function number channel 1	30h	81h	3101h	02h

CHxFN Function number channel x

In the following there are the measuring ranges with corresponding function number listed, which were supported by the analog module. With FFh the corresponding channel is deactivated. The formulas listed here allow you to transform an evaluated measuring value (digital value) to a value assigned to the measuring range (analog value) and vice versa.

0(4) ... 20mA

Meas. range (funct. no.)	Current (I)	Decimal (D)	Hex	Range	Formulas
0 ... 20mA Siemens S7 format (31h)	23.52mA	32511	7EFFh	overrange	$D = 27648 \cdot \frac{I}{20}$ $I = D \cdot \frac{20}{27648}$
	20mA	27648	6C00h	nominal range	
	10mA	13824	3600h		
	0mA	0	0000h		
	-3.52mA	-4864	ED00h	underrange	
0 ... 20mA Siemens S5 format (41h)	25.00mA	20480	5000h	overrange	$D = 16384 \cdot \frac{I}{20}$ $I = D \cdot \frac{20}{16384}$
	20mA	16384	4000h	nominal range	
	10mA	8192	2000h		
	0mA	0	0000h		
	-4,00mA	-3277	F333h	underrange	
4 ... 20mA Siemens S7 format (30h)	22.81mA	32511	7EFFh	overrange	$D = 27648 \cdot \frac{I-4}{16}$ $I = D \cdot \frac{16}{27648} + 4$
	20mA	27648	6C00h	nominal range	
	12mA	13824	3600h		
	4mA	0	0000h		
	1.19mA	-4864	ED00h	underrange	
4 ... 20mA Siemens S5 format (40h)	24.00mA	20480	5000h	overrange	$D = 16384 \cdot \frac{I-4}{16}$ $I = D \cdot \frac{16}{16384} + 4$
	20mA	16384	4000h	nominal range	
	12mA	8192	2000h		
	4mA	0	0000h		
	0.8mA	-3277	F333h	underrange	

3.7.3 Diagnostic data

So this module does not support diagnostic interrupt functions, the diagnostics data serve for information about this module. On error the corresponding channel LED of the module is activated and the error is registered in the diagnostics data.

The following errors are listed in the diagnostics data:

- Error in project engineering / parameterization
- Measuring range overflow
- Measuring range underflow

DS - Record set for access via CPU, PROFIBUS and PROFINET. The access happens by DS 01h. Additionally the first 4 bytes may be accessed by DS 00h.

IX - Index for access via CANopen. The access happens by IX 2F01h. Additionally the first 4 bytes may be accessed by IX 2F00h.

SX - Subindex for access via EtherCAT with Index 5005h.

More can be found in the according manual of your bus coupler.

Name	Bytes	Function	Default	DS	IX	SX
ERR_A	1	Diagnostic	00h	01h	2F01h	02h
MODTYP	1	Module information	15h			03h
ERR_C	1	reserved	00h			04h
ERR_D	1	Diagnostic	00h			05h
CHTYP	1	Channel type	71h			06h
NUMBIT	1	Number diagnostic bits per channel	08h			07h
NUMCH	1	Number of channels of a module	02h			08h
CHERR	1	Channel error	00h			09h
CH0ERR	1	Channel-specific error channel 0	00h			0Ah
CH1ERR	1	Channel-specific error channel 1	00h			0Bh
CH2ERR... CH7ERR	6	reserved	00h			0Ch ... 11h
DIAG_US	4	µs ticker	00h			13h

ERR_A Diagnostic

Byte	Bit 7 ... 0
0	<ul style="list-style-type: none"> ■ Bit 0: set at module failure ■ Bit 1: set at internal error ■ Bit 2: set at external error ■ Bit 3: set at channel error ■ Bit 4: set at external auxiliary supply missing ■ Bit 6 ... 5: reserved ■ Bit 7: set at error in parameterization

MODTYP Module information

Byte	Bit 7 ... 0
0	<ul style="list-style-type: none"> ■ Bit 3 ... 0: module class <ul style="list-style-type: none"> – 0101b analog module ■ Bit 4: set at channel information present ■ Bit 7 ... 5: reserved

ERR_D Diagnostic

Byte	Bit 7 ... 0
0	<ul style="list-style-type: none"> ■ Bit 2 ... 0: reserved ■ Bit 3: set at internal diagnostics buffer overflow ■ Bit 4: set at internal communication error ■ Bit 7 ... 5: reserved

CHTYP Channel type

Byte	Bit 7 ... 0
0	<ul style="list-style-type: none"> ■ Bit 6 ... 0: Channel type <ul style="list-style-type: none"> – 70h: Digital input – 71h: Analog input – 72h: Digital output – 73h: Analog output – 74h: Analog input/-output – 76h: Counter ■ Bit 7: reserved

NUMBIT Diagnostic bits

Byte	Bit 7 ... 0
0	Number of diagnostic bits per channel (here 08h)

NUMCH Channels

Byte	Bit 7 ... 0
0	Number of channels of a module (here 02h)

CHERR Channel error

Byte	Bit 7 ... 0
0	<ul style="list-style-type: none"> ■ Bit 0: set at error in channel group 0 ■ Bit 1: set at error in channel group 1 ■ Bit 7 ... 2: reserved

**CH0ERR / CH1ERR
Channel-specific**

Byte	Bit 7 ... 0
0	Channel-specific error channel x: <ul style="list-style-type: none"> ■ Bit 0: set at configuring/parameter assignment error ■ Bit 5 ... 1: reserved ■ Bit 6: set at measuring range underflow ■ Bit 7: set at measuring range overflow

**CH2ERR ... CH7ERR
reserved**

Byte	Bit 7 ... 0
0	reserved

DIAG_US μ s ticker

Byte	Bit 7 ... 0
0...3	Value of the μ s ticker at the moment of the diagnostic

 μ s ticker

In the System SLIO module there is a timer (μ s ticker). With PowerON the timer starts counting with 0. After $2^{32}-1\mu$ s the timer starts with 0 again.

3.8 031-1BB70 - AI 2x12Bit ±10V

Properties

The electronic module has 2 inputs with parameterizable functions. The channels of the module are electrically isolated from the backplane bus. In addition, the channels are isolated to the DC 24V power supply by means of DC/DC converter.

- 2 analog inputs
- Suited for sensors with ±10V, 0 ... 10V
- Diagnostics function
- 12bit resolution

Structure

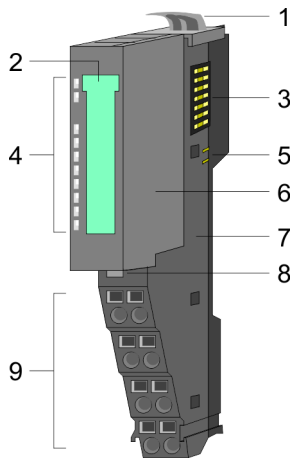

- 1 Locking lever terminal module
- 2 Labeling strip
- 3 Backplane bus
- 4 LED status indication
- 5 DC 24V power section supply
- 6 Electronic module
- 7 Terminal module
- 8 Locking lever electronic module
- 9 Terminal

Status indication

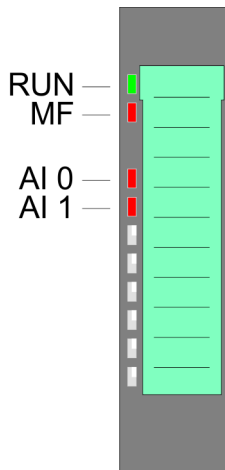

RUN	MF	AI x	Description
<input checked="" type="checkbox"/> green	<input checked="" type="checkbox"/> red	<input checked="" type="checkbox"/> red	
<input checked="" type="checkbox"/>	<input type="checkbox"/>	X	Bus communication is OK Module status is OK
<input checked="" type="checkbox"/>	<input checked="" type="checkbox"/>	X	Bus communication is OK Module status reports an error
<input type="checkbox"/>	<input checked="" type="checkbox"/>	X	Bus communication is not possible Module status reports an error
<input type="checkbox"/>	<input type="checkbox"/>	X	Error at bus power supply
X	<input checked="" type="checkbox"/> 2Hz	X	Error in configuration ↪ <i>Chap. 2.8 'Trouble shooting - LEDs' page 30</i>
<input checked="" type="checkbox"/>	<input type="checkbox"/>	<input checked="" type="checkbox"/>	Error channel x <ul style="list-style-type: none"> ■ Signal leaves measuring range ■ Error in parameterization
not relevant: X			

Pin assignment

For wires with a cross section of 0.08mm² up to 1.5mm².

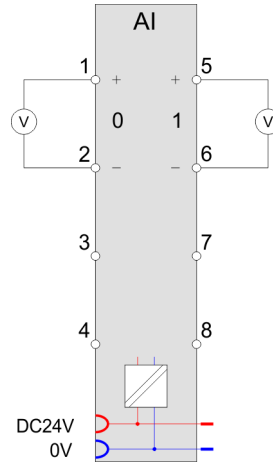
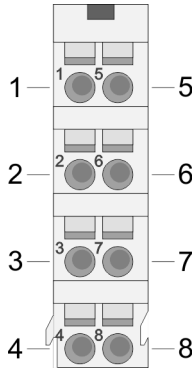

Pos.	Function	Type	Description
1	+AI 0	I	+ Channel 0
2	-AI 0	I	Ground Channel 0
3	---	---	not connected
4	---	---	not connected
5	+AI 1	I	+ Channel 1
6	-AI 1	I	Ground Channel 1
7	---	---	not connected
8	---	---	not connected

I: Input

In-/Output area

At CPU, PROFIBUS and PROFINET the input respectively output area is embedded to the corresponding address area.

IX - Index for access via CANopen with s = Subindex, depends on number and type of analog modules

SX - Subindex for access via EtherCAT with Index 6000h + EtherCAT-Slot

More can be found in the according manual of your bus coupler.

Input area

Addr.	Name	Bytes	Function	IX	SX
+0	AI 0	2	Analog value channel 0	6401h/s	01h
+2	AI 1	2	Analog value channel 1	6401h/s+1	02h

Output area

No byte of the output area is used by the module.

3.8.1 Technical data

Order no.	031-1BB70
Type	SM 031
Module ID	0408 15C3
Current consumption/power loss	
Current consumption from backplane bus	50 mA
Power loss	0.5 W
Technical data analog inputs	
Number of inputs	2
Cable length, shielded	200 m
Rated load voltage	DC 24 V
Current consumption from load voltage L+ (without load)	15 mA
Voltage inputs	✓
Min. input resistance (voltage range)	100 k Ω
Input voltage ranges	-10 V ... +10 V 0 V ... +10 V
Operational limit of voltage ranges	+/-0.3%
Operational limit of voltage ranges with SFU	-
Basic error limit voltage ranges	+/-0.2%
Basic error limit voltage ranges with SFU	-
Destruction limit voltage	max. 30V
Current inputs	-
Max. input resistance (current range)	-
Input current ranges	-
Operational limit of current ranges	-
Operational limit of current ranges with SFU	-
Basic error limit current ranges	-
Radical error limit current ranges with SFU	-
Destruction limit current inputs (voltage)	-
Destruction limit current inputs (electrical current)	-
Resistance inputs	-
Resistance ranges	-
Operational limit of resistor ranges	-
Operational limit of resistor ranges with SFU	-
Basic error limit	-
Basic error limit with SFU	-
Destruction limit resistance inputs	-

031-1BB70 - AI 2x12Bit $\pm 10V$ > Technical data

Order no.	031-1BB70
Resistance thermometer inputs	-
Resistance thermometer ranges	-
Operational limit of resistance thermometer ranges	-
Operational limit of resistance thermometer ranges with SFU	-
Basic error limit thermoresistor ranges	-
Basic error limit thermoresistor ranges with SFU	-
Destruction limit resistance thermometer inputs	-
Thermocouple inputs	-
Thermocouple ranges	-
Operational limit of thermocouple ranges	-
Operational limit of thermocouple ranges with SFU	-
Basic error limit thermoelement ranges	-
Basic error limit thermoelement ranges with SFU	-
Destruction limit thermocouple inputs	-
Programmable temperature compensation	-
External temperature compensation	-
Internal temperature compensation	-
Temperature error internal compensation	-
Technical unit of temperature measurement	-
Resolution in bit	12
Measurement principle	successive approximation
Basic conversion time	2 ms all channels
Noise suppression for frequency	>50dB at 50Hz (UCM<2V)
Status information, alarms, diagnostics	
Status display	yes
Interrupts	no
Process alarm	no
Diagnostic interrupt	no
Diagnostic functions	yes
Diagnostics information read-out	possible
Module state	green LED
Module error display	red LED
Channel error display	red LED per channel
Isolation	
Between channels	-

Order no.	031-1BB70
Between channels of groups to	-
Between channels and backplane bus	✓
Between channels and power supply	✓
Max. potential difference between circuits	-
Max. potential difference between inputs (Ucm)	DC 2 V
Max. potential difference between Mana and Mintern (Uiso)	-
Max. potential difference between inputs and Mana (Ucm)	-
Max. potential difference between inputs and Mintern (Uiso)	DC 75 V/ AC 50 V
Max. potential difference between Mintern and outputs	-
Insulation tested with	DC 500 V
Datasizes	
Input bytes	4
Output bytes	0
Parameter bytes	6
Diagnostic bytes	20
Housing	
Material	PPE / PPE GF10
Mounting	Profile rail 35 mm
Mechanical data	
Dimensions (WxHxD)	12.9 mm x 109 mm x 76.5 mm
Net weight	60 g
Weight including accessories	60 g
Gross weight	74 g
Environmental conditions	
Operating temperature	0 °C to 60 °C
Storage temperature	-25 °C to 70 °C
Certifications	
UL certification	yes
KC certification	yes

SFU - Interference frequency suppression

3.8.2 Parameter data

DS - Record set for access via CPU, PROFIBUS and PROFINET

IX - Index for access via CANopen

SX - Subindex for access via EtherCAT with Index 3100h + EtherCAT-Slot

More can be found in the according manual of your bus coupler.

Name	Bytes	Function	Default	DS	IX	SX
CH0FN	1	Function number channel 0	12h	80h	3100h	01h
CH1FN	1	Function number channel 1	12h	81h	3101h	02h

CHxFN Function number channel x

In the following there are the measuring ranges with function number listed, which were supported by the analog module. With FFh the corresponding channel is deactivated. The formulas listed here allow you to transform an evaluated measuring value (digital value) to a value assigned to the measuring range (analog value) and vice versa.

±10V

Meas. range (funct. no.)	Voltage (U)	Decimal (D)	Hex	Range	Formulas
±10V Siemens S7 format (12h)	11.76V	32511	7EFFh	overrange	$D = 27648 \cdot \frac{U}{10}$ $U = D \cdot \frac{10}{27648}$
	10V	27648	6C00h	nominal range	
	5V	13824	3600h		
	0V	0	0000h		
	-5V	-13824	CA00h		
	-10V	-27648	9400h		
	-11.76V	-32512	8100h	underrange	
±10V Siemens S5 format (22h)	12.5V	20480	5000h	overrange	$D = 16384 \cdot \frac{U}{10}$ $U = D \cdot \frac{10}{16384}$
	10V	16384	4000h	nominal range	
	5V	8192	2000h		
	0V	0	0000h		
	-5V	-8192	E000h		
	-10V	-16384	C000h		
	-12.5V	-20480	B000h	underrange	

0 ... 10V

Meas. range (funct. no.)	Voltage (U)	Decimal (D)	Hex	Range	Formulas
0 ... 10V Siemens S7 format (10h)	11.76V	32511	7EFFh	overrange	$D = 27648 \cdot \frac{U}{10}$ $U = D \cdot \frac{10}{27648}$
	10V	27648	6C00h	nominal range	
	5V	13824	3600h		
	0V	0	0000h		
	-1.76V	-4864	ED00h	underrange	
0 ... 10V Siemens S5 format (20h)	12.5V	20480	5000h	overrange	$D = 16384 \cdot \frac{U}{10}$ $U = D \cdot \frac{10}{16384}$
	10V	16384	4000h	nominal range	
	5V	8192	2000h		
	0V	0	0000h		
	-2V	-3277	F333h	underrange	

3.8.3 Diagnostic data

This module does not support diagnostic interrupt functions, the diagnostics data serve for information about this module. On error the corresponding channel LED of the module is activated and the error is registered in the diagnostics data.

The following errors are listed in the diagnostics data:

- Error in project engineering / parameterization
- Measuring range overflow
- Measuring range underflow

DS - Record set for access via CPU, PROFIBUS and PROFINET. The access happens by DS 01h. Additionally the first 4 bytes may be accessed by DS 00h.

IX - Index for access via CANopen. The access happens by IX 2F01h. Additionally the first 4 bytes may be accessed by IX 2F00h.

SX - Subindex for access via EtherCAT with Index 5005h.

More can be found in the according manual of your bus coupler.

Name	Bytes	Function	Default	DS	IX	SX
ERR_A	1	Diagnostic	00h	01h	2F01h	02h
MODTYP	1	Module information	15h			03h
ERR_C	1	reserved	00h			04h
ERR_D	1	Diagnostic	00h			05h
CHTYP	1	Channel type	71h			06h
NUMBIT	1	Number diagnostic bits per channel	08h			07h
NUMCH	1	Number of channels of a module	02h			08h
CHERR	1	Channel error	00h			09h

031-1BB70 - AI 2x12Bit ±10V > Diagnostic data

Name	Bytes	Function	Default	DS	IX	SX
CH0ERR	1	Channel-specific error channel 0	00h			0Ah
CH1ERR	1	Channel-specific error channel 1	00h			0Bh
CH2ERR... CH7ERR	6	reserved	00h			0Ch ... 11h
DIAG_US	4	µs ticker	00h			13h

ERR_A Diagnostic

Byte	Bit 7 ... 0
0	<ul style="list-style-type: none"> ■ Bit 0: set at module failure ■ Bit 1: set at internal error ■ Bit 2: set at external error ■ Bit 3: set at channel error ■ Bit 4: set at external auxiliary supply missing ■ Bit 6 ... 5: reserved ■ Bit 7: set at error in parameterization

MODTYP Module information

Byte	Bit 7 ... 0
0	<ul style="list-style-type: none"> ■ Bit 3 ... 0: module class <ul style="list-style-type: none"> – 0101b analog module ■ Bit 4: set at channel information present ■ Bit 7 ... 5: reserved

ERR_D Diagnostic

Byte	Bit 7 ... 0
0	<ul style="list-style-type: none"> ■ Bit 2 ... 0: reserved ■ Bit 3: set at internal diagnostics buffer overflow ■ Bit 4: set at internal communication error ■ Bit 7 ... 5: reserved

CHTYP Channel type

Byte	Bit 7 ... 0
0	<ul style="list-style-type: none"> ■ Bit 6 ... 0: Channel type <ul style="list-style-type: none"> – 70h: Digital input – 71h: Analog input – 72h: Digital output – 73h: Analog output – 74h: Analog input/-output – 76h: Counter ■ Bit 7: reserved

NUMBIT Diagnostic bits

Byte	Bit 7 ... 0
0	Number of diagnostic bits per channel (here 08h)

NUMCH Channels

Byte	Bit 7 ... 0
0	Number of channels of a module (here 02h)

CHERR Channel error

Byte	Bit 7 ... 0
0	<ul style="list-style-type: none"> ■ Bit 0: set at error in channel group 0 ■ Bit 1: set at error in channel group 1 ■ Bit 7 ... 2: reserved

**CH0ERR / CH1ERR
Channel-specific**

Byte	Bit 7 ... 0
0	Channel-specific error channel x: <ul style="list-style-type: none"> ■ Bit 0: set at configuring/parameter assignment error ■ Bit 5 ... 1: reserved ■ Bit 6: set at measuring range underflow ■ Bit 7: set at measuring range overflow

**CH2ERR ... CH7ERR
reserved**

Byte	Bit 7 ... 0
0	reserved

DIAG_US μs ticker

Byte	Bit 7 ... 0
0...3	Value of the μs ticker at the moment of the diagnostic

 μs ticker

In the System SLIO module there is a timer (μs ticker). With PowerON the timer starts counting with 0. After $2^{32}-1\mu s$ the timer starts with 0 again.

3.9 031-1BB90 - AI 2x16Bit TC

Properties

The electronic module has 2 inputs for temperature and voltage measuring with parameterizable functions. The channels of the module are isolated to the backplane bus.

- 2 analog inputs
- Suited for sensors with type J, K, N, R, S, T, B, C, E, L and for voltage measuring ± 80mV
- Interrupt and diagnostics function
- 16bit resolution
- Internal temperature compensation
- High potential gradient of DC140V/AC60V between the inputs

Structure

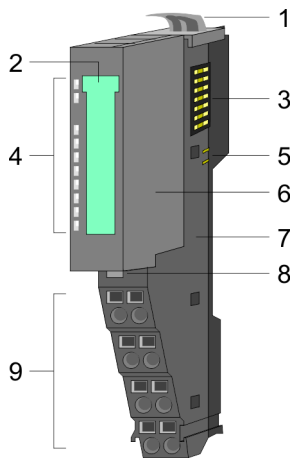

- 1 Locking lever terminal module
- 2 Labeling strip
- 3 Backplane bus
- 4 LED status indication
- 5 DC 24V power section supply
- 6 Electronic module
- 7 Terminal module
- 8 Locking lever electronic module
- 9 Terminal

Status indication

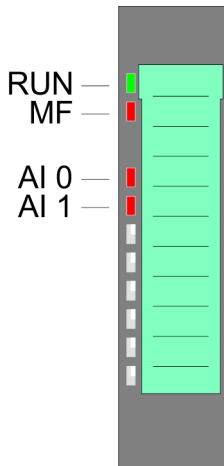

RUN ■ green	MF ■ red	AI x ■ red	Description
■	□	X	Bus communication is OK Module status is OK
■	■	X	Bus communication is OK Module status reports an error
□	■	X	Bus communication is not possible Module status reports an error
□	□	X	Error at bus power supply
X	▣ 2Hz	X	Error in configuration Chap. 2.8 'Trouble shooting - LEDs' page 30
■	□	■	Error channel x <ul style="list-style-type: none"> ■ Signal leaves measuring range ■ Error in parameterization ■ Wire break (if parameterized)
not relevant: X			

Pin assignment

For wires with a cross section of 0.08mm² up to 1.5mm².

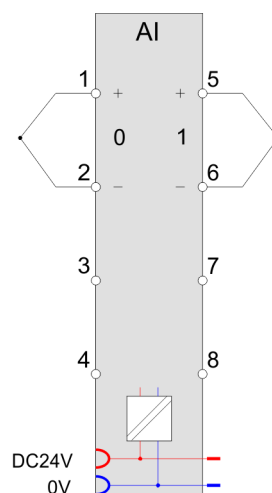
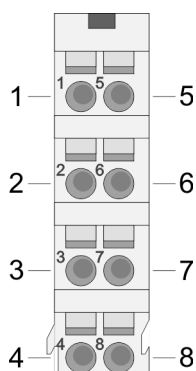

Pos.	Function	Type	Description
1	+TC 0	I	+ Channel 0
2	-TC 0	I	Ground Channel 0
3	---	---	not connected
4	---	---	not connected
5	+TC 1	I	+ Channel 1
6	-TC 1	I	Ground Channel 1
7	---	---	not connected
8	---	---	not connected

I: Input

**CAUTION!**

Please consider that the electronic module AI 2x16Bit TC may exclusively be used together with the terminal module 001-0AA20!



*Please take care of the correct polarity when installing the sensors!
Please install short circuits at non-used inputs by connecting the positive contact with the channel ground of the according channel.*

Supplementation to the installation guidelines

To avoid variations in temperature within the module, which may affect the accuracy of the measurement, you should consider the following points when assembling:

- Do not arrange the module directly apart from a power module with a high feeding current.
- Do not install the module at the end of a line.
- The module should be in a static condition, i.e. the temperature should be as constant as possible in the environment of your module (closed switchgear cabinet free from air draught).
- The accuracy is reached after approx. 30 minutes after entering the static condition.

In-/Output area

At CPU, PROFIBUS and PROFINET the input respectively output area is embedded to the corresponding address area.

IX - Index for access via CANopen with s = Subindex, depends on number and type of analog modules

SX - Subindex for access via EtherCAT with Index 6000h + EtherCAT-Slot

More can be found in the according manual of your bus coupler.

Input area

Addr.	Name	Bytes	Function	IX	SX
+0	AI 0	2	Analog value channel 0	6401h/s	01h
+2	AI 1	2	Analog value channel 1	6401h/s+1	02h

Output area

No byte of the output area is used by the module.

3.9.1 Technical data

Order no.	031-1BB90
Type	SM 031
Module ID	0403 1543
Current consumption/power loss	
Current consumption from backplane bus	85 mA
Power loss	1.1 W
Technical data analog inputs	
Number of inputs	2
Cable length, shielded	200 m
Rated load voltage	DC 24 V
Current consumption from load voltage L+ (without load)	30 mA
Voltage inputs	-
Min. input resistance (voltage range)	10 MΩ
Input voltage ranges	-80 mV ... +80 mV
Operational limit of voltage ranges	±0.3%
Operational limit of voltage ranges with SFU	±0.1%
Basic error limit voltage ranges	±0.25%
Basic error limit voltage ranges with SFU	±0.05%
Destruction limit voltage	max. 20V
Current inputs	-
Max. input resistance (current range)	-
Input current ranges	-
Operational limit of current ranges	-
Operational limit of current ranges with SFU	-
Basic error limit current ranges	-
Radical error limit current ranges with SFU	-
Destruction limit current inputs (voltage)	-
Destruction limit current inputs (electrical current)	-
Resistance inputs	-
Resistance ranges	-
Operational limit of resistor ranges	-
Operational limit of resistor ranges with SFU	-
Basic error limit	-
Basic error limit with SFU	-
Destruction limit resistance inputs	-
Resistance thermometer inputs	-

Order no.	031-1BB90
Resistance thermometer ranges	-
Operational limit of resistance thermometer ranges	-
Operational limit of resistance thermometer ranges with SFU	-
Basic error limit thermoresistor ranges	-
Basic error limit thermoresistor ranges with SFU	-
Destruction limit resistance thermometer inputs	-
Thermocouple inputs	✓
Thermocouple ranges	type B type C type E type J type K type L type N type R type S type T
Operational limit of thermocouple ranges	Type E, L, T, J, K, N: $\pm 2.5K$ / Type B, C, R, S: $\pm 8.0K$
Operational limit of thermocouple ranges with SFU	Type E, L, T, J, K, N: $\pm 1.5K$ / Type B, C, R, S: $\pm 4.0K$
Basic error limit thermoelement ranges	Type E, L, T, J, K, N: $\pm 2.0K$ / Type B, C, R, S: $\pm 7.0K$
Basic error limit thermoelement ranges with SFU	Type E, L, T, J, K, N: $\pm 1.0K$ / Type B, C, R, S: $\pm 3.0K$
Destruction limit thermocouple inputs	max. 20V
Programmable temperature compensation	✓
External temperature compensation	✓
Internal temperature compensation	✓
Temperature error internal compensation	1 K
Technical unit of temperature measurement	°C, °F, K
Resolution in bit	16
Measurement principle	Sigma-Delta
Basic conversion time	4.2...324.1 ms (50 Hz) 3.8...270.5 ms (60 Hz) per channel
Noise suppression for frequency	>90dB at 50Hz (UCM<10V)
Status information, alarms, diagnostics	
Status display	yes
Interrupts	yes
Process alarm	yes, parameterizable
Diagnostic interrupt	yes, parameterizable

Order no.	031-1BB90
Diagnostic functions	yes
Diagnostics information read-out	possible
Module state	green LED
Module error display	red LED
Channel error display	red LED per channel
Isolation	
Between channels	-
Between channels of groups to	-
Between channels and backplane bus	✓
Between channels and power supply	-
Max. potential difference between circuits	-
Max. potential difference between inputs (Ucm)	DC 75 V/ AC 50 V
Max. potential difference between Mana and Mintern (Uiso)	-
Max. potential difference between inputs and Mana (Ucm)	-
Max. potential difference between inputs and Mintern (Uiso)	DC 75 V/ AC 50 V
Max. potential difference between Mintern and outputs	-
Insulation tested with	DC 500 V
Datasizes	
Input bytes	4
Output bytes	0
Parameter bytes	22
Diagnostic bytes	20
Housing	
Material	PPE / PPE GF10
Mounting	Profile rail 35 mm
Mechanical data	
Dimensions (WxHxD)	12.9 mm x 109 mm x 76.5 mm
Net weight	58 g
Weight including accessories	58 g
Gross weight	72 g
Environmental conditions	
Operating temperature	0 °C to 60 °C
Storage temperature	-25 °C to 70 °C
Certifications	

Order no.	031-1BB90
UL certification	yes
KC certification	yes

SFU - Interference frequency suppression

The indicated error limits are valid starting from the following temperatures:

- Thermoelement type T: -200 °C
- Thermoelement type K: -100 °C
- Thermoelement type B: +700 °C
- Thermoelement type N: -150 °C
- Thermoelement type E: -150 °C
- Thermoelement type R: +200 °C
- Thermoelement type S: +100 °C
- Thermoelement type J: -100 °C

3.9.2 Parameter data

DS - Record set for access via CPU, PROFIBUS and PROFINET

IX - Index for access via CANopen

SX - Subindex for access via EtherCAT with Index 3100h + EtherCAT-Slot

More can be found in the according manual of your bus coupler.

Name	Bytes	Function	Default	DS	IX	SX
DIAG_EN	1	Diagnostics*	00h	00h	3100h	01h
WIBRK_EN	1	Wire break recognition*	00h	00h	3101h	02h
LIMIT_EN	1	Limit value monitoring*	00h	00h	3102h	03h
RES3	1	reserved*	00h	00h	3103h	04h
TEMPCNF	1	Temperature system	00h	01h	3104h	05h
SUPR	1	Interference frequency suppression (SFU)	02h	01h	3105h	06h
CH0FN	1	Function number channel 0	C1h	80h	3106h	07h
CH0FO	1	Function option channel 0	02h	80h	3107h	08h
CH0UL	2	Upper limit value channel 0	7FFFh	80h	3108h...3109h	09h
CH0LL	2	Lower limit value channel 0	8000h	80h	310Ah...310Bh	0Ah
CH1FN	1	Function number channel 1	C1h	81h	310Ch	0Bh
CH1FO	1	Function option channel 1	02h	81h	310Dh	0Ch
CH1UL	2	Upper limit value channel 1	7FFFh	81h	310Eh...310Fh	0Dh
CH1LL	2	Lower limit value channel 1	8000h	81h	3110h...3111h	0Eh

* This record set may only be transferred at STOP state.

DIAG_EN Diagnostic interrupt

Byte	Bit 7 ... 0
0	<ul style="list-style-type: none"> ■ Diagnostic interrupt <ul style="list-style-type: none"> – 00h: disabled – 40h: enabled

■ Here you can enable respectively disable the diagnostic interrupt.

WIBRK_EN
Wire break recognition

Byte	Bit 7 ... 0
0	<ul style="list-style-type: none"> ■ Bit 0: Wire break recognition channel 0 (1: on) ■ Bit 1: Wire break recognition channel 1 (1: on) ■ Bit 7 ... 2: reserved



Due to the high sensitivity of the inputs, unused inputs should be deactivated in the parametrization. Due to the high input impedance, open inputs can be influenced by adjacent channels or due to the measuring method during wire break detection. Since the entire measuring range moves in the mV range, open-loop inputs can already cause measuring range overshoots.

LIMIT_EN
Limit value monitoring

Byte	Bit 7 ... 0
0	<ul style="list-style-type: none"> ■ Bit 0: Limit value monitoring channel 0 (1: on) ■ Bit 1: Limit value monitoring channel 1 (1: on) ■ Bit 7 ... 2: reserved

TEMPCNF
Temperature system

Byte	Bit 7 ... 0
0	<ul style="list-style-type: none"> ■ Bit 0, 1: Temperature system <ul style="list-style-type: none"> – 00: °C – 01: °F – 10: K ■ Bit 7 ... 2: reserved

**SUPR Interference
frequency suppression
(SFU)**

Byte	Bit 7 ... 0
0	<ul style="list-style-type: none"> ■ Bit 0, 1: Interference frequency suppression <ul style="list-style-type: none"> – 01: 60Hz – 10: 50Hz ■ Bit 7 ... 2: reserved

**CHxFN Function number
channel x**

In the following there are the measuring ranges with corresponding function number listed, which were supported by the analog module.

With FFh the corresponding channel is deactivated.

Voltage

-80 ... 80mV

Meas. range (funct. no.)	Voltage (U)	Decimal (D)	Hex	Range	Formulas
-80 ... 80mV Siemens S7 format (11h)	94.07mV	32511	7EFFh	overrange	$D = 27648 \cdot \frac{U}{80}$ $U = D \cdot \frac{80}{27648}$
	80mV	27648	6C00h	nominal range	
	0V	0	0000h		
	-80mV	-27648	9400h		
	-94.07mV	-32512	8100h	underrange	
-80 ... 80mV Siemens S5 format (21h)	100mV	20480	5000h	overrange	$D = 16384 \cdot \frac{U}{80}$ $U = D \cdot \frac{80}{16384}$
	80mV	16384	4000h	nominal range	
	0V	0	0000h		
	-80mV	-16384	C000h		
	-100mV	-20480	B000h	underrange	

Temperature

Measuring range (funct. no.)	Measuring value in °C (0.1°C/digit)	Measuring value in °F (0.1°F/digit)	Measuring value in K (0.1K/digit)	Range
Type J: [Fe-Cu-Ni IEC] -210 ... +1200°C -346 ... 2192°F 63.2 ... 1473.2K (B0h: ext. comp. 0°C) (C0h: int. comp. 0°C)	+14500	26420	17232	overrange
	-2100 ... +12000	-3460 ... 21920	632 ... 14732	nominal range
	---	---	---	underrange
Type K: [Ni-Cr-Ni] -270 ... +1372°C -454 ... 2501.6°F 0 ... 1645.2K (B1h: ext. comp. 0°C) (C1h: int. comp. 0°C)	+16220	29516	18952	overrange
	-2700 ... +13720	-4540 ... 25016	0 ... 16452	nominal range
	---	---	---	underrange
Type N: [Ni-Cr-Si] -270 ... +1300°C -454 ... 2372°F 0 ... 1573.2K (B2h: ext. comp. 0°C)	+15500	28220	18232	overrange
	-2700 ... +13000	-4540 ... 23720	0 ... 15732	nominal range
	---	---	---	underrange

031-1BB90 - AI 2x16Bit TC > Parameter data

Measuring range (funct. no.)	Measuring value in °C (0.1°C/digit)	Measuring value in °F (0.1°F/digit)	Measuring value in K (0.1K/digit)	Range
(C2h: int. comp. 0°C)	---	---	---	underrange
Type R: [PtRh-Pt] -50 ... +1769°C -58 ... 3216.2°F 223.2 ... 2042.2K (B3h: ext. comp. 0°C) (C3h: int. comp. 0°C)	+20190 -500 ... +17690 -1700	32766 -580 ... 32162 -2740	22922 2232 ... 20422 1032	overrange nominal range underrange
Type S: [PtRh-Pt] -50 ... +1769°C -58 ... 3216.2°F 223.2 ... 2042.2K (B4h: ext. comp. 0°C) (C4h: int. comp. 0°C)	+20190 -500 ... +17690 -1700	32766 -580 ... 32162 -2740	22922 2232 ... 20422 1032	overrange nominal range underrange
Type T: [Cu-Cu-Ni] -270 ... +400°C -454 ... 752°F 3.2 ... 673.2K (B5h: ext. comp. 0°C) (C5h: int. comp. 0°C)	+5400 -2700 ... +4000 ---	10040 -4540 ... 7520 ---	8132 32 ... 6732 ---	overrange nominal range underrange
Type B: [PtRh-PtRh] 0 ... +1820°C 32 ... 2786.5°F 273.2 ... 2093.2K (B6h: ext. comp. 0°C) (C6h: int. comp. 0°C)	+20700 0 ... +18200 -1200	32766 320 ... 27865 -1840	23432 2732 ... 20932 1532	overrange nominal range underrange
Type C: [WRe5-WRe26] 0 ... +2315°C 32 ... 2786.5°F 273.2 ... 2093.2K (B7h: ext. comp. 0°C) (C7h: int. comp. 0°C)	+25000 0 ... +23150 -1200	32766 320 ... 27865 -1840	23432 2732 ... 20932 1532	overrange nominal range underrange
Type E:	+12000	21920	14732	overrange

Measuring range (funct. no.)	Measuring value in °C (0.1°C/digit)	Measuring value in °F (0.1°F/digit)	Measuring value in K (0.1K/digit)	Range
[Ni-Cr - Cu-Ni] -270 ... +1000°C -454 ... 1832°F 0 ... 1273.2K (B8h: ext. comp. 0°C) (C8h: int. comp. 0°C)	-2700 ... +10000	-4540 ... 18320	0 ... 12732	nominal range
	---	---	---	underrange
Type L: [Fe-Cu-Ni] -200 ... +900°C -328 ... 1652°F 73.2 ... 1173.2K (B9h: ext. comp. 0°C) (C9h: int. comp. 0°C)	+11500	21020	14232	overrange
	-2000 ... +9000	-3280 ... 16520	732 ... 11732	nominal range
	---	---	---	underrange

CHxFO Function option channel x

Depending on the Interference frequency suppression for each channel the transducer velocity may be set.

Code*	Velocity (in ms) / channel at interference frequency suppression	
	50Hz	60Hz
00h*	324.1	270.5
01h*	164.2	137.2
02h*	84.2	70.5
03h	44.1	37.2
04h	24.2	20.5
05h	14.2	12.2
06h	9.2	8.0
07h	6.6	5.9
08h	4.2	3.8

*) For Code 00h, 01h and 02h the tolerances of the technical data "with interference frequency suppression" are valid.

CHxUL / CHxLL Channel x

For each channel an *upper* and a *lower limit* may be defined. Here only values of the nominal range may be preset, otherwise you receive a parameterization error. By presetting 7FFFh for the upper respectively 8000h for the lower limit value the corresponding limit is deactivated. As soon as the measuring value is beyond the limits and the limit value monitoring is activated, a process interrupt is initialized.

3.9.3 Diagnostics and interrupt

Event	Process interrupt	Diagnostics interrupt	parameterizable
Error in project engineering/ parameterization	-	X	-
Wire break	-	X	X
Measuring range overflow	-	X	-
Measuring range underflow	-	X	-
Limit overflow	X	-	X
Limit underflow	X	-	X
Diagnostic buffer overflow	-	X	-
Communication error	-	X	-
Process interrupt lost	-	X	-

Process interrupt

So you may react to asynchronous events, there is the possibility to activate a process interrupt. A process interrupt interrupts the linear program sequence and jumps depending on the master system to a corresponding Interrupt routine. Here you can react to the process interrupt accordingly.

With CANopen the process interrupt data is transferred via an emergency telegram.

Operating with CPU, PROFIBUS and PROFINET the process interrupt data were transferred via diagnostics telegram.

SX - Subindex for access via EtherCAT with Index 5000h

More can be found in the according manual of your bus coupler.

Name	Bytes	Function	Default	SX
PRIT_OL	1	Upper limit overflow channel x	00h	02h
PRIT_UL	1	Lower limit underflow channel x	00h	03h
PRIT_US	2	µs-Ticker	00h	04h (high byte) 05h (low byte)

PRIT_OL Limit overflow

Byte	Bit 7 ... 0
0	Bit 0: Limit overflow channel 0 Bit 1: Limit overflow channel 1 Bit 7 ... 2: reserved

PRIT_UL Limit underflow

Byte	Bit 7 ... 0
0	Bit 0: Limit underflow channel 0 Bit 1: Limit underflow channel 1 Bit 7 ... 2: reserved

PRIT_US μ s ticker

Byte	Bit 7 ... 0
0 ... 1	16bit μ s value at the moment of the interrupt

 μ s ticker

In the SLIO module there is a 32 bit timer (μ s ticker). With PowerON the timer starts counting with 0. After $2^{32}-1\mu$ s the timer starts with 0 again. PRIT_US represents the lower 2 byte of the μ s ticker value ($0 \dots 2^{16}-1$).

Diagnostic data

Via the parameterization you may activate a diagnostic interrupt for the module. With a diagnostics interrupt the module serves for diagnostics data for diagnostic interrupt_{incoming}. As soon as the reason for releasing a diagnostic interrupt is no longer present, the diagnostic interrupt_{going} automatically takes place. All events of a channel between diagnostic interrupt_{incoming} and diagnostic interrupt_{going} are not stored and get lost. Within this time window (1. diagnostic interrupt_{incoming} until last diagnostic interrupt_{going}) the MF-LED of the module is on.

DS - Record set for access via CPU, PROFIBUS and PROFINET. The access happens by DS 01h. Additionally the first 4 bytes may be accessed by DS 00h.

IX - Index for access via CANopen. The access happens by IX 2F01h. Additionally the first 4 bytes may be accessed by IX 2F00h.

SX - Subindex for access via EtherCAT with Index 5005h.

More can be found in the according manual of your bus coupler.

Name	Bytes	Function	Default	DS	IX	SX
ERR_A	1	Diagnostic	00h	01h	2F01h	02h
MODTYP	1	Module information	15h			03h
RES2	1	reserved	00h			04h
ERR_D	1	Diagnostic	00h			05h
CHTYP	1	Channel type	71h			06h
NUMBIT	1	Number diagnostic bits per channel	08h			07h
NUMCH	1	Number of channels of a module	02h			08h
CHERR	1	Channel error	00h			09h
CH0ERR	1	Channel-specific error channel 0	00h			0Ah
CH1ERR	1	Channel-specific error channel 1	00h			0Bh
CH2ERR... CH7ERR	6	reserved	00h			0Ch ... 11h
DIAG_US	4	μ s ticker	00h			13h

ERR_A Diagnostic

Byte	Bit 7 ... 0
0	<ul style="list-style-type: none"> ■ Bit 0: set at module failure ■ Bit 1: set at internal error ■ Bit 2: set at external error ■ Bit 3: set at channel error ■ Bit 4: set at external auxiliary supply missing ■ Bit 6 ... 5: reserved ■ Bit 7: set at error in parameterization

MODTYP Module information

Byte	Bit 7 ... 0
0	<ul style="list-style-type: none"> ■ Bit 3 ... 0: module class <ul style="list-style-type: none"> – 0101b analog module ■ Bit 4: set at channel information present ■ Bit 7 ... 5: reserved

ERR_D Diagnostic

Byte	Bit 7 ... 0
0	<ul style="list-style-type: none"> ■ Bit 2 ... 0: reserved ■ Bit 3: set at internal diagnostics buffer overflow ■ Bit 4: set at internal communication error ■ Bit 5: reserved ■ Bit 6: set at process interrupt lost ■ Bit 7: reserved

CHTYP Channel type

Byte	Bit 7 ... 0
0	<ul style="list-style-type: none"> ■ Bit 6 ... 0: Channel type <ul style="list-style-type: none"> – 70h: Digital input – 71h: Analog input – 72h: Digital output – 73h: Analog output – 74h: Analog input/-output – 76h: Counter ■ Bit 7: reserved

NUMBIT Diagnostic bits

Byte	Bit 7 ... 0
0	Number of diagnostic bits per channel (here 08h)

NUMCH Channels

Byte	Bit 7 ... 0
0	Number of channels of a module (here 02h)

CHERR Channel error

Byte	Bit 7 ... 0
0	<ul style="list-style-type: none"> ■ Bit 0: set at error in channel group 0 ■ Bit 1: set at error in channel group 1 ■ Bit 7 ... 2: reserved

**CH0ERR / CH1ERR
Channel-specific**

Byte	Bit 7 ... 0
0	Channel-specific error: Channel x: <ul style="list-style-type: none"> ■ Bit 0: set at project engineering/parameterization error ■ Bit 3 ... 1: reserved ■ Bit 4: set at wire break ■ Bit 5: set at process interrupt lost ■ Bit 6: set at measuring range underflow ■ Bit 7: set at measuring range overflow

**CH2ERR ... CH7ERR
reserved**

Byte	Bit 7 ... 0
0	reserved

DIAG_US μ s ticker

Byte	Bit 7 ... 0
0...3	Value of the μ s ticker at the moment of the diagnostic

 μ s ticker

In the System SLIO module there is a timer (μ s ticker). With PowerON the timer starts counting with 0. After $2^{32}-1\mu$ s the timer starts with 0 again.

3.10 031-1BD30 - AI 4x12Bit 0...10V

Properties

The electronic module has 4 inputs with parameterizable functions. The channels of the module are electrically isolated from the backplane bus. In addition, the channels are isolated to the DC 24V power supply by means of DC/DC converter.

- 4 analog inputs
- Suited for sensors with 0 ... 10V
- Diagnostics function
- 12bit resolution

Structure

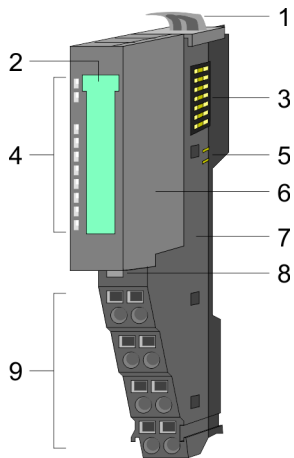

- 1 Locking lever terminal module
- 2 Labeling strip
- 3 Backplane bus
- 4 LED status indication
- 5 DC 24V power section supply
- 6 Electronic module
- 7 Terminal module
- 8 Locking lever electronic module
- 9 Terminal

Status indication

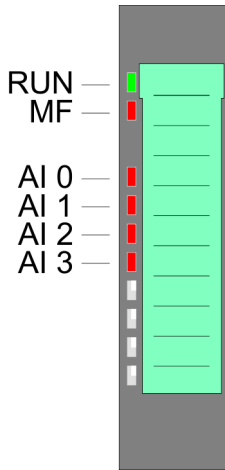

RUN	MF	AI x	Description
■ green	■ red	■ red	
■	<input type="checkbox"/>	X	Bus communication is OK Module status is OK
■	■	X	Bus communication is OK Module status reports an error
<input type="checkbox"/>	■	X	Bus communication is not possible Module status reports an error
<input type="checkbox"/>	<input type="checkbox"/>	X	Error at bus power supply
X	▣ 2Hz	X	Error in configuration ↗ <i>Chap. 2.8 'Trouble shooting - LEDs' page 30</i>
■	<input type="checkbox"/>	■	Error channel x <ul style="list-style-type: none"> ■ Signal leaves measuring range ■ Error in parameterization
not relevant: X			

Pin assignment

For wires with a cross section of 0.08mm² up to 1.5mm².

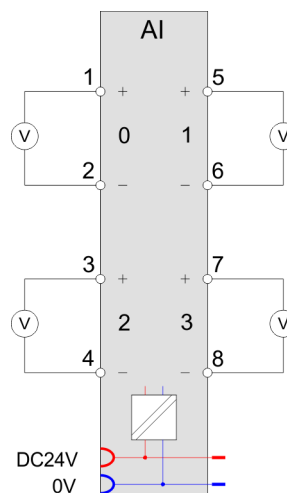
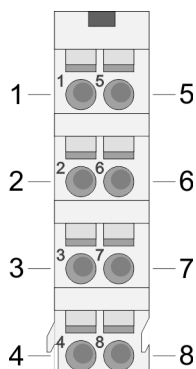

Pos.	Function	Type	Description
1	+AI 0	I	+ Channel 0
2	-AI 0	I	Ground Channel 0
3	+AI 2	I	+ Channel 2
4	-AI 2	I	Ground Channel 2
5	+AI 1	I	+ Channel 1
6	-AI 1	I	Ground Channel 1
7	+AI 3	I	+ Channel 3
8	-AI 3	I	Ground Channel 3

I: Input

In-/Output area

At CPU, PROFIBUS and PROFINET the input respectively output area is embedded to the corresponding address area.

IX - Index for access via CANopen with s = Subindex, depends on number and type of analog modules

SX - Subindex for access via EtherCAT with Index 6000h + EtherCAT-Slot

More can be found in the according manual of your bus coupler.

Input area

Addr.	Name	Bytes	Function	IX	SX
+0	AI 0	2	Analog value channel 0	6401h/s	01h
+2	AI 1	2	Analog value channel 1	6401h/s+1	02h
+4	AI 2	2	Analog value channel 2	6401h/s+2	03h
+6	AI 3	2	Analog value channel 3	6401h/s+3	04h

Output area

No byte of the output area is used by the module.

3.10.1 Technical data

Order no.	031-1BD30
Type	SM 031
Module ID	0404 15C4
Current consumption/power loss	
Current consumption from backplane bus	75 mA
Power loss	0.7 W
Technical data analog inputs	
Number of inputs	4
Cable length, shielded	200 m
Rated load voltage	DC 24 V
Current consumption from load voltage L+ (without load)	15 mA
Voltage inputs	✓
Min. input resistance (voltage range)	100 kΩ
Input voltage ranges	0 V ... +10 V
Operational limit of voltage ranges	+/-0.3%
Operational limit of voltage ranges with SFU	-
Basic error limit voltage ranges	+/-0.2%
Basic error limit voltage ranges with SFU	-
Destruction limit voltage	max. 30V
Current inputs	-
Max. input resistance (current range)	-
Input current ranges	-
Operational limit of current ranges	-
Operational limit of current ranges with SFU	-
Basic error limit current ranges	-
Radical error limit current ranges with SFU	-
Destruction limit current inputs (voltage)	-
Destruction limit current inputs (electrical current)	-
Resistance inputs	-
Resistance ranges	-
Operational limit of resistor ranges	-
Operational limit of resistor ranges with SFU	-
Basic error limit	-
Basic error limit with SFU	-
Destruction limit resistance inputs	-
Resistance thermometer inputs	-

Order no.	031-1BD30
Resistance thermometer ranges	-
Operational limit of resistance thermometer ranges	-
Operational limit of resistance thermometer ranges with SFU	-
Basic error limit thermoresistor ranges	-
Basic error limit thermoresistor ranges with SFU	-
Destruction limit resistance thermometer inputs	-
Thermocouple inputs	-
Thermocouple ranges	-
Operational limit of thermocouple ranges	-
Operational limit of thermocouple ranges with SFU	-
Basic error limit thermoelement ranges	-
Basic error limit thermoelement ranges with SFU	-
Destruction limit thermocouple inputs	-
Programmable temperature compensation	-
External temperature compensation	-
Internal temperature compensation	-
Temperature error internal compensation	-
Technical unit of temperature measurement	-
Resolution in bit	12
Measurement principle	successive approximation
Basic conversion time	4 ms all channels
Noise suppression for frequency	>50dB at 50Hz (UCM<2V)
Status information, alarms, diagnostics	
Status display	yes
Interrupts	no
Process alarm	no
Diagnostic interrupt	no
Diagnostic functions	yes
Diagnostics information read-out	possible
Module state	green LED
Module error display	red LED
Channel error display	red LED per channel
Isolation	
Between channels	-
Between channels of groups to	-

031-1BD30 - AI 4x12Bit 0...10V > Technical data

Order no.	031-1BD30
Between channels and backplane bus	✓
Between channels and power supply	✓
Max. potential difference between circuits	-
Max. potential difference between inputs (Ucm)	DC 2 V
Max. potential difference between Mana and Mintern (Uiso)	-
Max. potential difference between inputs and Mana (Ucm)	-
Max. potential difference between inputs and Mintern (Uiso)	DC 75 V/ AC 50 V
Max. potential difference between Mintern and outputs	-
Insulation tested with	DC 500 V
Datasizes	
Input bytes	8
Output bytes	0
Parameter bytes	8
Diagnostic bytes	20
Housing	
Material	PPE / PPE GF10
Mounting	Profile rail 35 mm
Mechanical data	
Dimensions (WxHxD)	12.9 mm x 109 mm x 76.5 mm
Net weight	59 g
Weight including accessories	59 g
Gross weight	74 g
Environmental conditions	
Operating temperature	0 °C to 60 °C
Storage temperature	-25 °C to 70 °C
Certifications	
UL certification	yes
KC certification	yes

SFU - Interference frequency suppression

3.10.2 Parameter data

DS - Record set for access via CPU, PROFIBUS and PROFINET

IX - Index for access via CANopen

SX - Subindex for access via EtherCAT with Index 3100h + EtherCAT-Slot

More can be found in the according manual of your bus coupler.

Name	Bytes	Function	Default	DS	IX	SX
CH0FN	1	Function number channel 0	10h	80h	3100h	01h
CH1FN	1	Function number channel 1	10h	81h	3101h	02h
CH2FN	1	Function number channel 2	10h	82h	3102h	03h
CH3FN	1	Function number channel 3	10h	83h	3103h	04h

CHxFN Function number channel x

In the following there are the measuring ranges with corresponding function number listed, which were supported by the analog module. With FFh the corresponding channel is deactivated. The formulas listed here allow you to transform an evaluated measuring value (digital value) to a value assigned to the measuring range (analog value) and vice versa.

0 ... 10V

Meas. range (funct. no.)	Voltage (U)	Decimal (D)	Hex	Range	Formulas
0 ... 10V Siemens S7 format (10h)	11.76V	32511	7EFFh	overrange	$D = 27648 \cdot \frac{U}{10}$ $U = D \cdot \frac{10}{27648}$
	10V	27648	6C00h	nominal range	
	5V	13824	3600h		
	0V	0	0000h		
	-1.76V	-4864	ED00h	underrange	
0 ... 10V Siemens S5 format (20h)	12.5V	20480	5000h	overrange	$D = 16384 \cdot \frac{U}{10}$ $U = D \cdot \frac{10}{16384}$
	10V	16384	4000h	nominal range	
	5V	8192	2000h		
	0V	0	0000h		
	-2V	-3277	F333h	underrange	

3.10.3 Diagnostic data

So this module does not support diagnostic interrupt functions, the diagnostics data serve for information about this module. On error the corresponding channel LED of the module is activated and the error is registered in the diagnostics data.

The following errors are listed in the diagnostics data:

- Error in project engineering / parameterization
- Measuring range overflow
- Measuring range underflow

DS - Record set for access via CPU, PROFIBUS and PROFINET. The access happens by DS 01h. Additionally the first 4 bytes may be accessed by DS 00h.

IX - Index for access via CANopen. The access happens by IX 2F01h. Additionally the first 4 bytes may be accessed by IX 2F00h.

SX - Subindex for access via EtherCAT with Index 5005h.

More can be found in the according manual of your bus coupler.

Name	Bytes	Function	Default	DS	IX	SX
ERR_A	1	Diagnostic	00h	01h	2F01h	02h
MODTYP	1	Module information	15h			03h
ERR_C	1	reserved	00h			04h
ERR_D	1	Diagnostic	00h			05h
CHTYP	1	Channel type	71h			06h
NUMBIT	1	Number diagnostic bits per channel	08h			07h
NUMCH	1	Number of channels of a module	04h			08h
CHERR	1	Channel error	00h			09h
CH0ERR	1	Channel-specific error channel 0	00h			0Ah
CH1ERR	1	Channel-specific error channel 1	00h			0Bh
CH2ERR	1	Channel-specific error channel 2	00h			0Ch
CH3ERR	1	Channel-specific error channel 3	00h			0Dh
CH4ERR...CH7ERR	4	reserved	00h			0Eh ... 11h
DIAG_US	4	µs ticker	00h			13h

ERR_A Diagnostic

Byte	Bit 7 ... 0
0	<ul style="list-style-type: none"> ■ Bit 0: set at module failure ■ Bit 1: set at internal error ■ Bit 2: set at external error ■ Bit 3: set at channel error ■ Bit 4: set at external auxiliary supply missing ■ Bit 6 ... 5: reserved ■ Bit 7: set at error in parameterization

MODTYP Module information

Byte	Bit 7 ... 0
0	<ul style="list-style-type: none"> ■ Bit 3 ... 0: module class <ul style="list-style-type: none"> – 0101b analog module ■ Bit 4: set at channel information present ■ Bit 7 ... 5: reserved

ERR_D Diagnostic

Byte	Bit 7 ... 0
0	<ul style="list-style-type: none"> ■ Bit 2 ... 0: reserved ■ Bit 3: set at internal diagnostics buffer overflow ■ Bit 4: set at internal communication error ■ Bit 7 ... 5: reserved

CHTYP Channel type

Byte	Bit 7 ... 0
0	<ul style="list-style-type: none"> ■ Bit 6 ... 0: Channel type <ul style="list-style-type: none"> – 70h: Digital input – 71h: Analog input – 72h: Digital output – 73h: Analog output – 74h: Analog input/output – 76h: Counter ■ Bit 7: reserved

NUMBIT Diagnostic bits

Byte	Bit 7 ... 0
0	Number of diagnostic bits per channel (here 08h)

NUMCH Channels

Byte	Bit 7 ... 0
0	Number of channels of a module (here 04h)

CHERR Channel error

Byte	Bit 7 ... 0
0	<ul style="list-style-type: none"> ■ Bit 0: set at error in channel group 0 ■ Bit 1: set at error in channel group 1 ■ Bit 2: set at error in channel group 2 ■ Bit 3: set at error in channel group 3 ■ Bit 7 ... 4: reserved

CH0ERR ... CH3ERR Channel-specific

Byte	Bit 7 ... 0
0	Channel-specific error channel x: <ul style="list-style-type: none"> ■ Bit 0: set at configuring/parameter assignment error ■ Bit 5 ... 1: reserved ■ Bit 6: set at measuring range underflow ■ Bit 7: set at measuring range overflow

031-1BD30 - AI 4x12Bit 0...10V > Diagnostic data

CH4ERR ... CH7ERR
reserved

Byte	Bit 7 ... 0
0	reserved

DIAG_US μ s ticker

Byte	Bit 7 ... 0
0...3	Value of the μ s ticker at the moment of the diagnostic

μ s ticker

In the System SLIO module there is a timer (μ s ticker). With PowerON the timer starts counting with 0. After $2^{32}-1\mu$ s the timer starts with 0 again.

3.11 031-1BD40 - AI 4x12Bit 0(4)...20mA

Properties

The electronic module has 4 inputs with parameterizable functions. The channels of the module are electrically isolated from the backplane bus. In addition, the channels are isolated to the DC 24V power supply by means of DC/DC converter.

- 4 analog inputs
- Suited for sensors with 0 ... 20mA;
4 ... 20mA with external supply
- Diagnostics function
- 12bit resolution

Structure

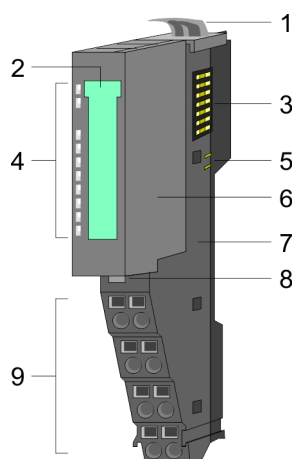

- 1 Locking lever terminal module
- 2 Labeling strip
- 3 Backplane bus
- 4 LED status indication
- 5 DC 24V power section supply
- 6 Electronic module
- 7 Terminal module
- 8 Locking lever electronic module
- 9 Terminal

Status indication

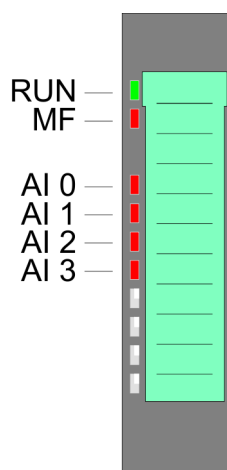

RUN	MF	AI x	Description
<input checked="" type="checkbox"/> green	<input checked="" type="checkbox"/> red	<input checked="" type="checkbox"/> red	
<input checked="" type="checkbox"/>	<input type="checkbox"/>	X	Bus communication is OK Module status is OK
<input checked="" type="checkbox"/>	<input checked="" type="checkbox"/>	X	Bus communication is OK Module status reports an error
<input type="checkbox"/>	<input checked="" type="checkbox"/>	X	Bus communication is not possible Module status reports an error
<input type="checkbox"/>	<input type="checkbox"/>	X	Error at bus power supply
X	<input checked="" type="checkbox"/> 2Hz	X	Error in configuration Chap. 2.8 'Trouble shooting - LEDs' page 30
<input checked="" type="checkbox"/>	<input type="checkbox"/>	<input checked="" type="checkbox"/>	Error channel x <ul style="list-style-type: none"> ■ Signal leaves measuring range ■ Error in parameterization
not relevant: X			

Pin assignment

For wires with a cross section of 0.08mm² up to 1.5mm².

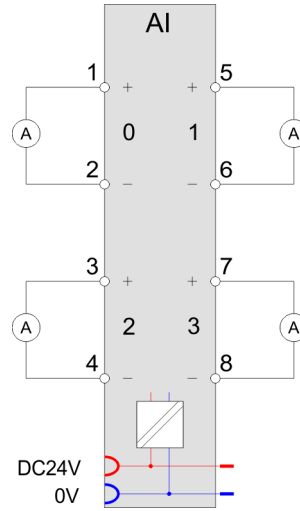
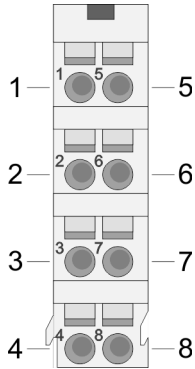

I: Input

Pos.	Function	Type	Description
1	+AI 0	I	+ Channel 0
2	-AI 0	I	Ground Channel 0
3	+AI 2	I	+ Channel 2
4	-AI 2	I	Ground Channel 2
5	+AI 1	I	+ Channel 1
6	-AI 1	I	Ground Channel 1
7	+AI 3	I	+ Channel 3
8	-AI 3	I	Ground Channel 3

I: Input



If a 2wire measuring transducer is used, you have to connect in line an external power supply.

In-/Output area

At CPU, PROFIBUS and PROFINET the input respectively output area is embedded to the corresponding address area.

IX - Index for access via CANopen with s = Subindex, depends on number and type of analog modules

SX - Subindex for access via EtherCAT with Index 6000h + EtherCAT-Slot

More can be found in the according manual of your bus coupler.

Input area

Addr.	Name	Bytes	Function	IX	SX
+0	AI 0	2	Analog value channel 0	6401h/s	01h
+2	AI 1	2	Analog value channel 1	6401h/s+1	02h

Addr.	Name	Bytes	Function	IX	SX
+4	AI 2	2	Analog value channel 2	6401h/s+2	03h
+6	AI 3	2	Analog value channel 3	6401h/s+3	04h

Output area

No byte of the output area is used by the module.

3.11.1 Technical data

Order no.	031-1BD40
Type	SM 031
Module ID	0405 15C4
Current consumption/power loss	
Current consumption from backplane bus	75 mA
Power loss	0.7 W
Technical data analog inputs	
Number of inputs	4
Cable length, shielded	200 m
Rated load voltage	DC 24 V
Current consumption from load voltage L+ (without load)	15 mA
Voltage inputs	-
Min. input resistance (voltage range)	-
Input voltage ranges	-
Operational limit of voltage ranges	-
Operational limit of voltage ranges with SFU	-
Basic error limit voltage ranges	-
Basic error limit voltage ranges with SFU	-
Destruction limit voltage	-
Current inputs	✓
Max. input resistance (current range)	110 Ω
Input current ranges	0 mA ... +20 mA +4 mA ... +20 mA
Operational limit of current ranges	+/-0.3% ... +/-0.5%
Operational limit of current ranges with SFU	-
Basic error limit current ranges	+/-0.2% ... +/-0.3%
Radical error limit current ranges with SFU	-
Destruction limit current inputs (voltage)	max. 24V
Destruction limit current inputs (electrical current)	max. 40mA

031-1BD40 - AI 4x12Bit 0(4)...20mA > Technical data

Order no.	031-1BD40
Resistance inputs	-
Resistance ranges	-
Operational limit of resistor ranges	-
Operational limit of resistor ranges with SFU	-
Basic error limit	-
Basic error limit with SFU	-
Destruction limit resistance inputs	-
Resistance thermometer inputs	-
Resistance thermometer ranges	-
Operational limit of resistance thermometer ranges	-
Operational limit of resistance thermometer ranges with SFU	-
Basic error limit thermoresistor ranges	-
Basic error limit thermoresistor ranges with SFU	-
Destruction limit resistance thermometer inputs	-
Thermocouple inputs	-
Thermocouple ranges	-
Operational limit of thermocouple ranges	-
Operational limit of thermocouple ranges with SFU	-
Basic error limit thermoelement ranges	-
Basic error limit thermoelement ranges with SFU	-
Destruction limit thermocouple inputs	-
Programmable temperature compensation	-
External temperature compensation	-
Internal temperature compensation	-
Temperature error internal compensation	-
Technical unit of temperature measurement	-
Resolution in bit	12
Measurement principle	successive approximation
Basic conversion time	4 ms all channels
Noise suppression for frequency	>50dB at 50Hz (UCM<2V)
Status information, alarms, diagnostics	
Status display	yes
Interrupts	no
Process alarm	no
Diagnostic interrupt	no

Order no.	031-1BD40
Diagnostic functions	yes
Diagnostics information read-out	possible
Module state	green LED
Module error display	red LED
Channel error display	red LED per channel
Isolation	
Between channels	-
Between channels of groups to	-
Between channels and backplane bus	✓
Between channels and power supply	✓
Max. potential difference between circuits	-
Max. potential difference between inputs (Ucm)	DC 2 V
Max. potential difference between Mana and Mintern (Uiso)	-
Max. potential difference between inputs and Mana (Ucm)	-
Max. potential difference between inputs and Mintern (Uiso)	DC 75 V/ AC 50 V
Max. potential difference between Mintern and outputs	-
Insulation tested with	DC 500 V
Datasizes	
Input bytes	8
Output bytes	0
Parameter bytes	8
Diagnostic bytes	20
Housing	
Material	PPE / PPE GF10
Mounting	Profile rail 35 mm
Mechanical data	
Dimensions (WxHxD)	12.9 mm x 109 mm x 76.5 mm
Net weight	60 g
Weight including accessories	60 g
Gross weight	75 g
Environmental conditions	
Operating temperature	0 °C to 60 °C
Storage temperature	-25 °C to 70 °C
Certifications	

031-1BD40 - AI 4x12Bit 0(4)...20mA > Parameter data

Order no.	031-1BD40
UL certification	yes
KC certification	yes

SFU - Interference frequency suppression

3.11.2 Parameter data

DS - Record set for access via CPU, PROFIBUS and PROFINET

IX - Index for access via CANopen

SX - Subindex for access via EtherCAT with Index 3100h + EtherCAT-Slot

More can be found in the according manual of your bus coupler.

Name	Bytes	Function	Default	DS	IX	SX
CH0FN	1	Function number channel 0	31h	80h	3100h	01h
CH1FN	1	Function number channel 1	31h	81h	3101h	02h
CH2FN	1	Function number channel 2	31h	82h	3102h	03h
CH3FN	1	Function number channel 3	31h	83h	3103h	04h

CHxFN Function number channel x

In the following there are the measuring ranges with corresponding function number listed, which were supported by the analog module. With FFh the corresponding channel is deactivated. The formulas listed here allow you to transform an evaluated measuring value (digital value) to a value assigned to the measuring range (analog value) and vice versa.

0(4) ... 20mA

Meas. range (funct. no.)	Current (I)	Decimal (D)	Hex	Range	Formulas
0 ... 20mA Siemens S7 format (31h)	23.52mA	32511	7EFFh	overrange	$D = 27648 \cdot \frac{I}{20}$ $I = D \cdot \frac{20}{27648}$
	20mA	27648	6C00h	nominal range	
	10mA	13824	3600h		
	0mA	0	0000h		
	-3.52mA	-4864	ED00h	underrange	
0 ... 20mA Siemens S5 format (41h)	25.00mA	20480	5000h	overrange	$D = 16384 \cdot \frac{I}{20}$ $I = D \cdot \frac{20}{16384}$
	20mA	16384	4000h	nominal range	
	10mA	8192	2000h		
	0mA	0	0000h		
	-4,00mA	-3277	F333h	underrange	
4 ... 20mA Siemens S7 format (30h)	22.81mA	32511	7EFFh	overrange	$D = 27648 \cdot \frac{I-4}{16}$ $I = D \cdot \frac{16}{27648} + 4$
	20mA	27648	6C00h	nominal range	
	12mA	13824	3600h		
	4mA	0	0000h		
	1.19mA	-4864	ED00h	underrange	
4 ... 20mA Siemens S5 format (40h)	24.00mA	20480	5000h	overrange	$D = 16384 \cdot \frac{I-4}{16}$ $I = D \cdot \frac{16}{16384} + 4$
	20mA	16384	4000h	nominal range	
	12mA	8192	2000h		
	4mA	0	0000h		
	0.8mA	-3277	F333h	underrange	

3.11.3 Diagnostic data

So this module does not support diagnostic interrupt functions, the diagnostics data serve for information about this module. On error the corresponding channel LED of the module is activated and the error is registered in the diagnostics data.

The following errors are listed in the diagnostics data:

- Error in project engineering / parameterization
- Measuring range overflow
- Measuring range underflow

DS - Record set for access via CPU, PROFIBUS and PROFINET. The access happens by DS 01h. Additionally the first 4 bytes may be accessed by DS 00h.

IX - Index for access via CANopen. The access happens by IX 2F01h. Additionally the first 4 bytes may be accessed by IX 2F00h.

SX - Subindex for access via EtherCAT with Index 5005h.

More can be found in the according manual of your bus coupler.

031-1BD40 - AI 4x12Bit 0(4)...20mA > Diagnostic data

Name	Bytes	Function	Default	DS	IX	SX
ERR_A	1	Diagnostic	00h	01h	2F01h	02h
MODTYP	1	Module information	15h			03h
ERR_C	1	reserved	00h			04h
ERR_D	1	Diagnostic	00h			05h
CHTYP	1	Channel type	71h			06h
NUMBIT	1	Number diagnostic bits per channel	08h			07h
NUMCH	1	Number of channels of a module	04h			08h
CHERR	1	Channel error	00h			09h
CH0ERR	1	Channel-specific error channel 0	00h			0Ah
CH1ERR	1	Channel-specific error channel 1	00h			0Bh
CH2ERR	1	Channel-specific error channel 2	00h			0Ch
CH3ERR	1	Channel-specific error channel 3	00h			0Dh
CH4ERR ... CH7ERR	4	reserved	00h			0Eh ... 11h
DIAG_US	4	µs-Ticker	00h			13h

ERR_A Diagnostic

Byte	Bit 7 ... 0
0	<ul style="list-style-type: none"> ■ Bit 0: set at module failure ■ Bit 1: reserved ■ Bit 2: set at external error ■ Bit 3: set at channel error ■ Bit 4: set at external auxiliary supply missing ■ Bit 6 ... 5: reserved ■ Bit 7: set at error in parameterization

MODTYP Module information

Byte	Bit 7 ... 0
0	<ul style="list-style-type: none"> ■ Bit 3 ... 0: module class <ul style="list-style-type: none"> – 0101b analog module ■ Bit 4: set at channel information present ■ Bit 7 ... 5: reserved

ERR_D Diagnostic

Byte	Bit 7 ... 0
0	<ul style="list-style-type: none"> ■ Bit 2 ... 0: reserved ■ Bit 3: set at internal diagnostics buffer overflow ■ Bit 4: set at internal communication error ■ Bit 7 ... 5: reserved

CHTYP Channel type

Byte	Bit 7 ... 0
0	<ul style="list-style-type: none"> ■ Bit 6 ... 0: Channel type <ul style="list-style-type: none"> – 70h: Digital input – 71h: Analog input – 72h: Digital output – 73h: Analog output – 74h: Analog input/-output – 76h: Counter ■ Bit 7: reserved

NUMBIT Diagnostic bits

Byte	Bit 7 ... 0
0	Number of diagnostic bits per channel (here 08h)

NUMCH Channels

Byte	Bit 7 ... 0
0	Number of channels of a module (here 04h)

CHERR Channel error

Byte	Bit 7 ... 0
0	<ul style="list-style-type: none"> ■ Bit 0: set at error in channel group 0 ■ Bit 1: set at error in channel group 1 ■ Bit 2: set at error in channel group 2 ■ Bit 3: set at error in channel group 3 ■ Bit 7 ... 4: reserved

**CH0ERR ... CH3ERR
Channel-specific**

Byte	Bit 7 ... 0
0	Channel-specific error channel x: <ul style="list-style-type: none"> ■ Bit 0: set at configuring/parameter assignment error ■ Bit 5 ... 1: reserved ■ Bit 6: set at measuring range underflow ■ Bit 7: set at measuring range overflow

**CH4ERR ... CH7ERR
reserved**

Byte	Bit 7 ... 0
0	reserved

031-1BD40 - AI 4x12Bit 0(4)...20mA > Diagnostic data

DIAG_US μ s ticker

Byte	Bit 7 ... 0
0...3	Value of the μ s ticker at the moment of the diagnostic

 μ s ticker

In the System SLIO module there is a timer (μ s ticker). With PowerON the timer starts counting with 0. After $2^{32}-1\mu$ s the timer starts with 0 again.

3.12 031-1BD70 - AI 4x12Bit ±10V

Properties

The electronic module has 4 inputs with parameterizable functions. The channels of the module are electrically isolated from the backplane bus. In addition, the channels are isolated to the DC 24V power supply by means of DC/DC converter.

- 4 analog inputs
- Suited for sensors with ±10V, 0 ... 10V
- Diagnostics function
- 12bit resolution

Structure

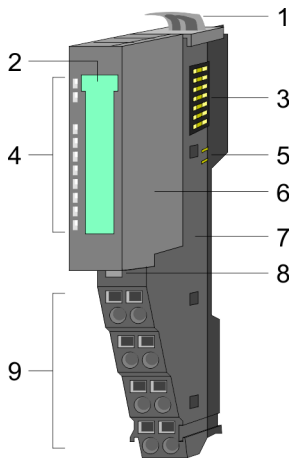

- 1 Locking lever terminal module
- 2 Labeling strip
- 3 Backplane bus
- 4 LED status indication
- 5 DC 24V power section supply
- 6 Electronic module
- 7 Terminal module
- 8 Locking lever electronic module
- 9 Terminal

Status indication

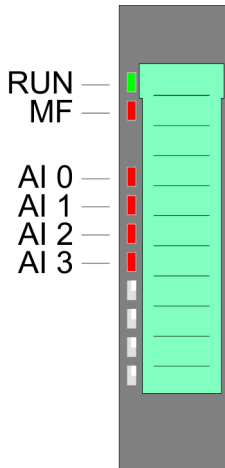

RUN	MF	AI x	Description
<input checked="" type="checkbox"/> green	<input checked="" type="checkbox"/> red	<input checked="" type="checkbox"/> red	
<input checked="" type="checkbox"/>	<input type="checkbox"/>	X	Bus communication is OK Module status is OK
<input checked="" type="checkbox"/>	<input checked="" type="checkbox"/>	X	Bus communication is OK Module status reports an error
<input type="checkbox"/>	<input checked="" type="checkbox"/>	X	Bus communication is not possible Module status reports an error
<input type="checkbox"/>	<input type="checkbox"/>	X	Error at bus power supply
X	<input checked="" type="checkbox"/> 2Hz	X	Error in configuration ↗ <i>Chap. 2.8 'Trouble shooting - LEDs' page 30</i>
<input checked="" type="checkbox"/>	<input type="checkbox"/>	<input checked="" type="checkbox"/>	Error channel x <ul style="list-style-type: none"> ■ Signal leaves measuring range ■ Error in parameterization
not relevant: X			

Pin assignment

For wires with a cross section of 0.08mm² up to 1.5mm².

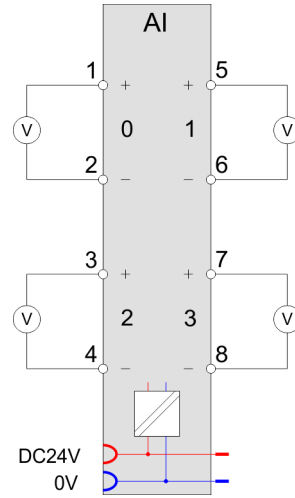
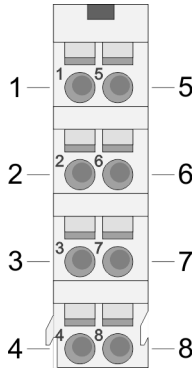

Pos.	Function	Type	Description
1	+AI 0	I	+ Channel 0
2	-AI 0	I	Ground Channel 0
3	+AI 2	I	+ Channel 2
4	-AI 2	I	Ground Channel 2
5	+AI 1	I	+ Channel 1
6	-AI 1	I	Ground Channel 1
7	+AI 3	I	+ Channel 3
8	-AI 3	I	Ground Channel 3

I: Input

In-/Output area

At CPU, PROFIBUS and PROFINET the input respectively output area is embedded to the corresponding address area.

IX - Index for access via CANopen with s = Subindex, depends on number and type of analog modules

SX - Subindex for access via EtherCAT with Index 6000h + EtherCAT-Slot

More can be found in the according manual of your bus coupler.

Input area

Addr.	Name	Bytes	Function	IX	SX
+0	AI 0	2	Analog value channel 0	6401h/s	01h
+2	AI 1	2	Analog value channel 1	6401h/s+1	02h
+4	AI 2	2	Analog value channel 2	6401h/s+2	03h
+6	AI 3	2	Analog value channel 3	6401h/s+3	04h

Output area

No byte of the output area is used by the module.

3.12.1 Technical data

Order no.	031-1BD70
Type	SM 031
Module ID	0409 15C4
Current consumption/power loss	
Current consumption from backplane bus	55 mA
Power loss	0.5 W
Technical data analog inputs	
Number of inputs	4
Cable length, shielded	200 m
Rated load voltage	DC 24 V
Current consumption from load voltage L+ (without load)	15 mA
Voltage inputs	✓
Min. input resistance (voltage range)	100 k Ω
Input voltage ranges	-10 V ... +10 V 0 V ... +10 V
Operational limit of voltage ranges	+/-0.3%
Operational limit of voltage ranges with SFU	-
Basic error limit voltage ranges	+/-0.2%
Basic error limit voltage ranges with SFU	-
Destruction limit voltage	max. 30V
Current inputs	-
Max. input resistance (current range)	-
Input current ranges	-
Operational limit of current ranges	-
Operational limit of current ranges with SFU	-
Basic error limit current ranges	-
Radical error limit current ranges with SFU	-
Destruction limit current inputs (voltage)	-
Destruction limit current inputs (electrical current)	-
Resistance inputs	-
Resistance ranges	-
Operational limit of resistor ranges	-
Operational limit of resistor ranges with SFU	-
Basic error limit	-
Basic error limit with SFU	-
Destruction limit resistance inputs	-

031-1BD70 - AI 4x12Bit $\pm 10V$ > Technical data

Order no.	031-1BD70
Resistance thermometer inputs	-
Resistance thermometer ranges	-
Operational limit of resistance thermometer ranges	-
Operational limit of resistance thermometer ranges with SFU	-
Basic error limit thermoresistor ranges	-
Basic error limit thermoresistor ranges with SFU	-
Destruction limit resistance thermometer inputs	-
Thermocouple inputs	-
Thermocouple ranges	-
Operational limit of thermocouple ranges	-
Operational limit of thermocouple ranges with SFU	-
Basic error limit thermoelement ranges	-
Basic error limit thermoelement ranges with SFU	-
Destruction limit thermocouple inputs	-
Programmable temperature compensation	-
External temperature compensation	-
Internal temperature compensation	-
Temperature error internal compensation	-
Technical unit of temperature measurement	-
Resolution in bit	12
Measurement principle	successive approximation
Basic conversion time	4 ms all channels
Noise suppression for frequency	>50dB at 50Hz (UCM<2V)
Status information, alarms, diagnostics	
Status display	yes
Interrupts	no
Process alarm	no
Diagnostic interrupt	no
Diagnostic functions	yes
Diagnostics information read-out	possible
Module state	green LED
Module error display	red LED
Channel error display	red LED per channel
Isolation	
Between channels	-

Order no.	031-1BD70
Between channels of groups to	-
Between channels and backplane bus	✓
Between channels and power supply	✓
Max. potential difference between circuits	-
Max. potential difference between inputs (Ucm)	DC 2 V
Max. potential difference between Mana and Mintern (Uiso)	-
Max. potential difference between inputs and Mana (Ucm)	-
Max. potential difference between inputs and Mintern (Uiso)	DC 75 V/ AC 50 V
Max. potential difference between Mintern and outputs	-
Insulation tested with	DC 500 V
Datasizes	
Input bytes	8
Output bytes	0
Parameter bytes	8
Diagnostic bytes	20
Housing	
Material	PPE / PPE GF10
Mounting	Profile rail 35 mm
Mechanical data	
Dimensions (WxHxD)	12.9 mm x 109 mm x 76.5 mm
Net weight	60 g
Weight including accessories	60 g
Gross weight	75 g
Environmental conditions	
Operating temperature	0 °C to 60 °C
Storage temperature	-25 °C to 70 °C
Certifications	
UL certification	yes
KC certification	yes

SFU - Interference frequency suppression

3.12.2 Parameter data

DS - Record set for access via CPU, PROFIBUS and PROFINET

IX - Index for access via CANopen

SX - Subindex for access via EtherCAT with Index 3100h + EtherCAT-Slot

More can be found in the according manual of your bus coupler.

Name	Bytes	Function	Default	DS	IX	SX
CH0FN	1	Function number channel 0	12h	80h	3100h	01h
CH1FN	1	Function number channel 1	12h	81h	3101h	02h
CH2FN	1	Function number channel 2	12h	82h	3102h	03h
CH3FN	1	Function number channel 3	12h	83h	3103h	04h

CHxFN Function number channel x

In the following there are the measuring ranges with corresponding function number listed, which were supported by the analog module. With FFh the corresponding channel is deactivated. The formulas listed here allow you to transform an evaluated measuring value (digital value) to a value assigned to the measuring range (analog value) and vice versa.

±10V

Meas. range (funct. no.)	Voltage (U)	Decimal (D)	Hex	Range	Formulas
±10V Siemens S7 format (12h)	11.76V	32511	7EFFh	overrange	$D = 27648 \cdot \frac{U}{10}$ $U = D \cdot \frac{10}{27648}$
	10V	27648	6C00h	nominal range	
	5V	13824	3600h		
	0V	0	0000h		
	-5V	-13824	CA00h		
	-10V	-27648	9400h	underrange	
	-11.76V	-32512	8100h		
±10V Siemens S5 format (22h)	12.5V	20480	5000h	overrange	$D = 16384 \cdot \frac{U}{10}$ $U = D \cdot \frac{10}{16384}$
	10V	16384	4000h	nominal range	
	5V	8192	2000h		
	0V	0	0000h		
	-5V	-8192	E000h		
	-10V	-16384	C000h		
	-12.5V	-20480	B000h		

0 ... 10V

Meas. range (funct. no.)	Voltage (U)	Decimal (D)	Hex	Range	Formulas
0 ... 10V Siemens S7 format (10h)	11.76V	32511	7EFFh	overrange	$D = 27648 \cdot \frac{U}{10}$ $U = D \cdot \frac{10}{27648}$
	10V	27648	6C00h	nominal range	
	5V	13824	3600h		
	0V	0	0000h		
	-1.76V	-4864	ED00h	underrange	
0 ... 10V Siemens S5 format (20h)	12.5V	20480	5000h	overrange	$D = 16384 \cdot \frac{U}{10}$ $U = D \cdot \frac{10}{16384}$
	10V	16384	4000h	nominal range	
	5V	8192	2000h		
	0V	0	0000h		
	-2V	-3277	F333h	underrange	

3.12.3 Diagnostic data

So this module does not support diagnostic interrupt functions, the diagnostics data serve for information about this module. On error the corresponding channel LED of the module is activated and the error is registered in the diagnostics data.

The following errors are listed in the diagnostics data:

- Error in project engineering / parameterization
- Measuring range overflow
- Measuring range underflow

DS - Record set for access via CPU, PROFIBUS and PROFINET. The access happens by DS 01h. Additionally the first 4 bytes may be accessed by DS 00h.

IX - Index for access via CANopen. The access happens by IX 2F01h. Additionally the first 4 bytes may be accessed by IX 2F00h.

SX - Subindex for access via EtherCAT with Index 5005h.

More can be found in the according manual of your bus coupler.

Name	Bytes	Function	Default	DS	IX	SX
ERR_A	1	Diagnostic	00h	01h	2F01h	02h
MODTYP	1	Module information	15h			03h
ERR_C	1	reserved	00h			04h
ERR_D	1	Diagnostic	00h			05h
CHTYP	1	Channel type	71h			06h
NUMBIT	1	Number diagnostic bits per channel	08h			07h
NUMCH	1	Number of channels of a module	04h			08h
CHERR	1	Channel error	00h			09h

031-1BD70 - AI 4x12Bit ±10V > Diagnostic data

Name	Bytes	Function	Default	DS	IX	SX
CH0ERR	1	Channel-specific error channel 0	00h			0Ah
CH1ERR	1	Channel-specific error channel 1	00h			0Bh
CH2ERR	1	Channel-specific error channel 2	00h			0Ch
CH3ERR	1	Channel-specific error channel 3	00h			0Dh
CH4ERR...CH7ERR	4	reserved	00h			0Eh ... 11h
DIAG_US	4	µs ticker	00h			13h

ERR_A Diagnostic

Byte	Bit 7 ... 0
0	<ul style="list-style-type: none"> ■ Bit 0: set at module failure ■ Bit 1: set at internal error ■ Bit 2: set at external error ■ Bit 3: set at channel error ■ Bit 4: set at external auxiliary supply missing ■ Bit 6 ... 5: reserved ■ Bit 7: set at error in parameterization

MODTYP Module information

Byte	Bit 7 ... 0
0	<ul style="list-style-type: none"> ■ Bit 3 ... 0: module class <ul style="list-style-type: none"> – 0101b analog module ■ Bit 4: set at channel information present ■ Bit 7 ... 5: reserved

ERR_D Diagnostic

Byte	Bit 7 ... 0
0	<ul style="list-style-type: none"> ■ Bit 2 ... 0: reserved ■ Bit 3: set at internal diagnostics buffer overflow ■ Bit 4: set at internal communication error ■ Bit 7 ... 5: reserved

CHTYP Channel type

Byte	Bit 7 ... 0
0	<ul style="list-style-type: none"> ■ Bit 6 ... 0: Channel type <ul style="list-style-type: none"> – 70h: Digital input – 71h: Analog input – 72h: Digital output – 73h: Analog output – 74h: Analog input/output – 76h: Counter ■ Bit 7: reserved

NUMBIT Diagnostic bits

Byte	Bit 7 ... 0
0	Number of diagnostic bits per channel (here 08h)

NUMCH Channels

Byte	Bit 7 ... 0
0	Number of channels of a module (here 04h)

CHERR Channel error

Byte	Bit 7 ... 0
0	<ul style="list-style-type: none"> ■ Bit 0: set at error in channel group 0 ■ Bit 1: set at error in channel group 1 ■ Bit 2: set at error in channel group 2 ■ Bit 3: set at error in channel group 3 ■ Bit 7 ... 4: reserved

**CH0ERR ... CH3ERR
Channel-specific**

Byte	Bit 7 ... 0
0	Channel-specific error channel x: <ul style="list-style-type: none"> ■ Bit 0: set at configuring/parameter assignment error ■ Bit 5 ... 1: reserved ■ Bit 6: set at measuring range underflow ■ Bit 7: set at measuring range overflow

**CH4ERR ... CH7ERR
reserved**

Byte	Bit 7 ... 0
0	reserved

DIAG_US μ s ticker

Byte	Bit 7 ... 0
0...3	Value of the μ s ticker at the moment of the diagnostic

 μ s ticker

In the System SLIO module there is a timer (μ s ticker). With PowerON the timer starts counting with 0. After $2^{32}-1\mu$ s the timer starts with 0 again.

3.13 031-1BD80 - AI 4x16Bit R/RTD

Properties

The electronic module has 4 inputs for resistance measurement with parameterizable functions. The channels of the module are isolated to the backplane bus.

- 4 analog inputs
- Suited for resistance-type sensors 0 ... 3000Ω and resistance temperature sensors Pt100, Pt1000, NI100, NI120 and NI1000
- Resistance measurement with 2, 3 and 4 wire (3 and 4 wire only via channel 0 respectively 1)
- Interrupt and diagnostics function
- 16bit resolution

Structure

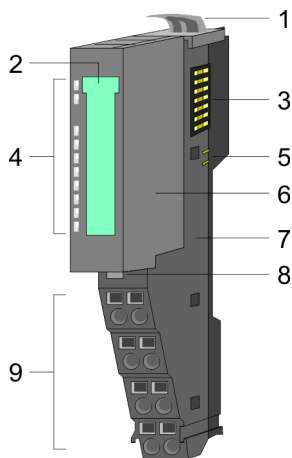

- 1 Locking lever terminal module
- 2 Labeling strip
- 3 Backplane bus
- 4 LED status indication
- 5 DC 24V power section supply
- 6 Electronic module
- 7 Terminal module
- 8 Locking lever electronic module
- 9 Terminal

Status indication

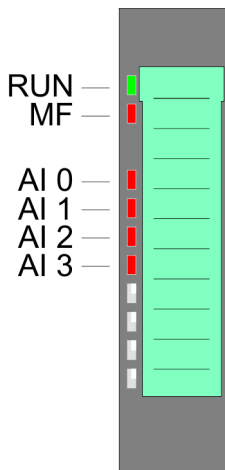

RUN	MF	AI x	Description
■ green	■ red	■ red	
■	<input type="checkbox"/>	X	Bus communication is OK Module status is OK
■	■	X	Bus communication is OK Module status reports an error
<input type="checkbox"/>	■	X	Bus communication is not possible Module status reports an error
<input type="checkbox"/>	<input type="checkbox"/>	X	Error at bus power supply
X	▣ 2Hz	X	Error in configuration ↗ <i>Chap. 2.8 'Trouble shooting - LEDs' page 30</i>
■	<input type="checkbox"/>	■	Error channel x <ul style="list-style-type: none"> ■ Signal leaves measuring range ■ Error in parameterization ■ Wire break (if parameterized)

not relevant: X

Pin assignment

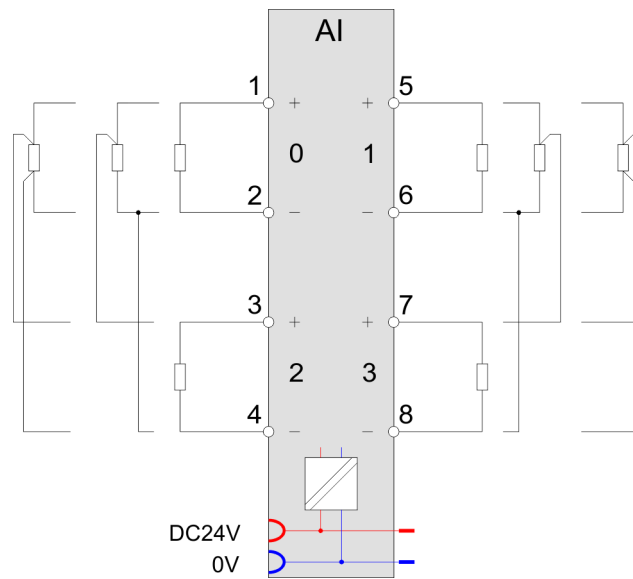
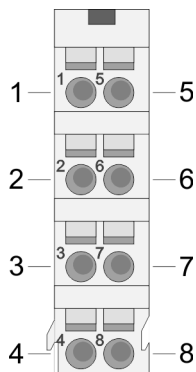
For wires with a cross section of 0.08mm² up to 1.5mm².

Pos.	Function	Type	Description
1	+AI 0	I	+ Channel 0
2	-AI 0	I	Ground Channel 0
3	+AI 2	I	+ Channel 2
4	-AI 2	I	Ground Channel 2
5	+AI 1	I	+ Channel 1
6	-AI 1	I	Ground Channel 1
7	+AI 3	I	+ Channel 3
8	-AI 3	I	Ground Channel 3

I: Input

2, 3, 4 wire measurement

At the pin assignment above you can see how the sensors are to be connected at 2, 3 respectively 4 wire measurement.

- With every channel a 2 wire measurement may be performed.
- 3 wire measurement is only possible via the channels 0 and 1.
 - Please consider with 3 wire measurement that the corresponding channel is always deactivated in the parametrization. The corresponding channel of channel 0 is channel 2 and of channel 1 is channel 3. Not used channels must always be de-activated in the parametrization.
- 4 wire measurement is only possible via the channels 0 and 1.
 - The measurement current for channel 0 is applied at pin 1 and 2. The measurement for channel 0 happens at pin 3 and 4. The analog value for channel 0 is represented in input word 0.
 - The measurement current for channel 1 is applied at pin 5 and 6. The measurement for channel 1 happens at pin 7 and 8. The analog value for channel 1 is represented in input word 1.
 - Please consider with 4 wire measurement that the corresponding channel is always deactivated in the parametrization. The corresponding channel of channel 0 is channel 2 and of channel 1 is channel 3. Not used channels must always be de-activated in the parametrization.

In-/Output area

At CPU, PROFIBUS and PROFINET the input respectively output area is embedded to the corresponding address area.

IX - Index for access via CANopen with s = Subindex, depends on number and type of analog modules

SX - Subindex for access via EtherCAT with Index 6000h + EtherCAT-Slot

More can be found in the according manual of your bus coupler.

Input area

Addr.	Name	Bytes	Function	IX	SX
+0	AI 0	2	Analog value channel 0	6401h/s	01h
+2	AI 1	2	Analog value channel 1	6401h/s+1	02h
+4	AI 2	2	Analog value channel 2	6401h/s+2	03h
+6	AI 3	2	Analog value channel 3	6401h/s+3	04h

Output area

No byte of the output area is used by the module.

3.13.1 Technical data

Order no.	031-1BD80
Type	SM 031
Module ID	0406 1544
Current consumption/power loss	
Current consumption from backplane bus	85 mA
Power loss	1 W
Technical data analog inputs	
Number of inputs	4
Cable length, shielded	200 m
Rated load voltage	DC 24 V
Current consumption from load voltage L+ (without load)	30 mA
Voltage inputs	-
Min. input resistance (voltage range)	-
Input voltage ranges	-
Operational limit of voltage ranges	-
Operational limit of voltage ranges with SFU	-
Basic error limit voltage ranges	-
Basic error limit voltage ranges with SFU	-
Destruction limit voltage	-
Current inputs	-
Max. input resistance (current range)	-
Input current ranges	-
Operational limit of current ranges	-
Operational limit of current ranges with SFU	-
Basic error limit current ranges	-
Radical error limit current ranges with SFU	-
Destruction limit current inputs (voltage)	-
Destruction limit current inputs (electrical current)	-
Resistance inputs	✓
Resistance ranges	0 ... 60 Ohm 0 ... 600 Ohm 0 ... 3000 Ohm
Operational limit of resistor ranges	+/- 0.4 %
Operational limit of resistor ranges with SFU	+/- 0,2 %
Basic error limit	+/- 0.2 %
Basic error limit with SFU	+/- 0,1 %

Order no.	031-1BD80
Destruction limit resistance inputs	max. 24V
Resistance thermometer inputs	✓
Resistance thermometer ranges	Pt100 Pt1000 Ni100 Ni120 Ni1000
Operational limit of resistance thermometer ranges	+/- 0.4 %
Operational limit of resistance thermometer ranges with SFU	+/- 0,2 %
Basic error limit thermoresistor ranges	+/- 0.2 %
Basic error limit thermoresistor ranges with SFU	+/- 0,1 %
Destruction limit resistance thermometer inputs	max. 24V
Thermocouple inputs	-
Thermocouple ranges	-
Operational limit of thermocouple ranges	-
Operational limit of thermocouple ranges with SFU	-
Basic error limit thermoelement ranges	-
Basic error limit thermoelement ranges with SFU	-
Destruction limit thermocouple inputs	-
Programmable temperature compensation	-
External temperature compensation	-
Internal temperature compensation	-
Temperature error internal compensation	-
Technical unit of temperature measurement	°C, °F, K
Resolution in bit	16
Measurement principle	Sigma-Delta
Basic conversion time	4.2...324.1 ms (50 Hz) 3.8...270.5 ms (60 Hz) per channel
Noise suppression for frequency	>80dB at 50Hz (UCM<6V)
Status information, alarms, diagnostics	
Status display	yes
Interrupts	yes, parameterizable
Process alarm	yes, parameterizable
Diagnostic interrupt	yes, parameterizable
Diagnostic functions	yes
Diagnostics information read-out	possible
Module state	green LED

Order no.	031-1BD80
Module error display	red LED
Channel error display	red LED per channel
Isolation	
Between channels	-
Between channels of groups to	-
Between channels and backplane bus	✓
Between channels and power supply	-
Max. potential difference between circuits	-
Max. potential difference between inputs (Ucm)	DC 6 V
Max. potential difference between Mana and Mintern (Uiso)	-
Max. potential difference between inputs and Mana (Ucm)	-
Max. potential difference between inputs and Mintern (Uiso)	DC 75 V/ AC 50 V
Max. potential difference between Mintern and outputs	-
Insulation tested with	DC 500 V
Technical data encoder supply	
Number of outputs	-
Output voltage (typ)	-
Output voltage (rated value)	-
Short-circuit protection	-
Binding of potential	-
Datasizes	
Input bytes	8
Output bytes	0
Parameter bytes	34
Diagnostic bytes	20
Housing	
Material	PPE / PPE GF10
Mounting	Profile rail 35 mm
Mechanical data	
Dimensions (WxHxD)	12.9 mm x 109 mm x 76.5 mm
Net weight	61 g
Weight including accessories	61 g
Gross weight	75 g
Environmental conditions	
Operating temperature	0 °C to 60 °C

031-1BD80 - AI 4x16Bit R/RTD > Technical data

Order no.	031-1BD80
Storage temperature	-25 °C to 70 °C
Certifications	
UL certification	yes
KC certification	yes

SFU - Interference frequency suppression

3.13.2 Parameter data

DS - Record set for access via CPU, PROFIBUS and PROFINET

IX - Index for access via CANopen

SX - Subindex for access via EtherCAT with Index 3100h + EtherCAT-Slot

More can be found in the according manual of your bus coupler.

Name	Bytes	Function	Default	DS	IX	SX
DIAG_EN	1	Diagnostics ¹	00h	00h	3100h	01h
WIBRK_EN	1	Wire break recognition ¹	00h	00h	3101h	02h
LIMIT_EN	1	Limit value monitoring ¹	00h	00h	3102h	03h
RES3	1	reserved	00h	00h	3103h	04h
TEMPCNF	1	Temperature system	00h	01h	3104h	05h
SUPR	1	Interference frequency suppression (SFU)	02h	01h	3105h	06h
CH0FN	1	Function number channel 0	50h	80h	3106h	07h
CH0FO	1	Function option channel 0	00h	80h	3107h	08h
CH0UL	2	Upper limit value channel 0	7FFFh	80h	3108h...3109h	09h
CH0LL	2	Lower limit value channel 0	8000h	80h	310Ah...310Bh	0Ah
CH1FN	1	Function number channel 1	50h	81h	310Ch	0Bh
CH1FO	1	Function option channel 1	00h	81h	310Dh	0Ch
CH1UL	2	Upper limit value channel 1	7FFFh	81h	310Eh...310Fh	0Dh
CH1LL	2	Lower limit value channel 1	8000h	81h	3110h...3111h	0Eh
CH2FN	1	Function number channel 2	50h ²	82h	3112h	0Fh
CH2FO	1	Function option channel 2	00h	82h	3113h	10h
CH2UL	2	Upper limit value channel 2	7FFFh	82h	3114h...3115h	11h
CH2LL	2	Lower limit value channel 2	8000h	82h	3116h...3117h	12h
CH3FN	1	Function number channel 3	50h ²	83h	3118h	13h
CH3FO	1	Function option channel 3	00h	83h	3119h	14h
CH3UL	2	Upper limit value channel 3	7FFFh	83h	311Ah...311Bh	15h
CH3LL	2	Lower limit value channel 3	8000h	83h	311Ch...311Dh	16h

1) This record set may only be transferred at STOP state.

2) with 2 channel operation FFh

DIAG_EN Diagnostic interrupt

Byte	Bit 7 ... 0
0	<ul style="list-style-type: none"> ■ Diagnostic interrupt <ul style="list-style-type: none"> – 00h: disabled – 40h: enabled

■ Here you can enable respectively disable the diagnostic interrupt.

WIBRK_EN Wire break recognition

Byte	Bit 7 ... 0
0	<ul style="list-style-type: none"> ■ Bit 0: Wire break recognition channel 0 (1: on) ■ Bit 1: Wire break recognition channel 1 (1: on) ■ Bit 2: Wire break recognition channel 2 (1: on) ■ Bit 3: Wire break recognition channel 3 (1: on) ■ Bit 7 ... 4: reserved

LIMIT_EN Limit value monitoring

Byte	Bit 7 ... 0
0	<ul style="list-style-type: none"> ■ Bit 0: Limit value monitoring channel 0 (1: on) ■ Bit 1: Limit value monitoring channel 1 (1: on) ■ Bit 2: Limit value monitoring channel 2 (1: on) ■ Bit 3: Limit value monitoring channel 3 (1: on) ■ Bit 7 ... 4: reserved

TEMPCNF Temperature system

Byte	Bit 7 ... 0
0	<ul style="list-style-type: none"> ■ Bit 0, 1: Temperature system <ul style="list-style-type: none"> – 00: °C – 01: °F – 10: K ■ Bit 7 ... 2: reserved

SUPR Interference frequency suppression (SFU)

Byte	Bit 7 ... 0
0	<ul style="list-style-type: none"> ■ Bit 0, 1: Interference frequency suppression <ul style="list-style-type: none"> – 01: 60Hz – 10: 50Hz ■ Bit 7 ... 2: reserved

CHxFN Function number channel x

In the following there are the measuring ranges with corresponding function number listed, which were supported by the analog module. With FFh the corresponding channel is deactivated.

Measuring range (funct. no.)	Measuring value	Signal range	Range
2 wire: PT100 (50h)	+1000°C	+10000	overrange
	-200 ... +850°C	-2000 ... +8500	nominal range
	-243°C	-2430	underrange

Measuring range (funct. no.)	Measuring value	Signal range	Range
2 wire: PT1000 (51h)	+1000°C	+10000	overrange
	-200 ... +850°C	-2000 ... +8500	nominal range
	-243°C	-2430	underrange
2 wire: NI100 (52h)	+295°C	+2950	overrange
	-60 ... +250°C	-600 ... +2500	nominal range
	-105°C	-1050	underrange
2 wire: NI1000 (53h)	+295°C	+2950	overrange
	-60 ... +250°C	-600 ... +2500	nominal range
	-105°C	-1050	underrange
2 wire: NI120 (54h)	+300°C	+3000	overrange
	-80 ... +260°C	-800 ... +2600	nominal range
	-110°C	-1100	underrange
3 wire: PT100 (58h)	+1000°C	+10000	overrange
	-200 ... +850°C	-2000 ... +8500	nominal range
	-243°C	-2430	underrange
3 wire: PT1000 (59h)	+1000°C	+10000	overrange
	-200 ... +850°C	-2000 ... +8500	nominal range
	-243°C	-2430	underrange
3 wire: NI100 (5Ah)	+295°C	+2950	overrange
	-60 ... +250°C	-600 ... +2500	nominal range
	-105°C	-1050	underrange
3 wire: NI1000 (5Bh)	+295°C	+2950	overrange
	-60 ... +250°C	-600 ... +2500	nominal range
	-105°C	-1050	underrange
3 wire: NI120 (5Ch)	+300°C	+3000	overrange
	-80 ... +260°C	-800 ... +2600	nominal range
	-110°C	-1100	underrange
4 wire: PT100 (60h)	+1000°C	+10000	overrange
	-200 ... +850°C	-2000 ... +8500	nominal range
	-243°C	-2430	underrange
4 wire: PT1000 (61h)	+1000°C	+10000	overrange
	-200 ... +850°C	-2000 ... +8500	nominal range
	-243°C	-2430	underrange
4 wire: NI100 (62h)	+295°C	+2950	overrange
	-60 ... +250°C	-600 ... +2500	nominal range

Measuring range (funct. no.)	Measuring value	Signal range	Range
	-105°C	-1050	underrange
4 wire: NI1000 (63h)	+295°C	+2950	overrange
	-60 ... +250°C	-600 ... +2500	nominal range
	-105°C	-1050	underrange
4 wire: NI120 (64h)	+300°C	+3000	overrange
	-80 ... +260°C	-800 ... +2600	nominal range
	-110°C	-1100	underrange
2 wire: 0 ... 60Ω (70h)	---	---	overrange
	0 ... 60Ω	0 ... 32767	nominal range
	---	---	underrange
2 wire: 0 ... 600Ω (71h)	---	---	overrange
	0 ... 600Ω	0 ... 32767	nominal range
	---	---	underrange
2 wire: 0 ... 3000Ω (72h)	---	---	overrange
	0 ... 3000Ω	0 ... 32767	nominal range
	---	---	underrange
3 wire: 0 ... 60Ω (78h)	---	---	overrange
	0 ... 60Ω	0 ... 32767	nominal range
	---	---	underrange
3 wire: 0 ... 600Ω (79h)	---	---	overrange
	0 ... 600Ω	0 ... 32767	nominal range
	---	---	underrange
3 wire: 0 ... 3000Ω (7Ah)	---	---	overrange
	0 ... 3000Ω	0 ... 32767	nominal range
	---	---	underrange
4 wire: 0 ... 60Ω (80h)	---	---	overrange
	0 ... 60Ω	0 ... 32767	nominal range
	---	---	underrange
4 wire: 0 ... 600Ω (81h)	---	---	overrange
	0 ... 600Ω	0 ... 32767	nominal range
	---	---	underrange
4 wire: 0 ... 3000Ω (82h)	---	---	overrange
	0 ... 3000Ω	0 ... 32767	nominal range
	---	---	underrange
2 wire: 0 ... 60Ω	---	---	overrange

Measuring range (funct. no.)	Measuring value	Signal range	Range
(90h)	0 ... 60Ω	0 ... 6000	nominal range
	---	---	underrange
2 wire: 0 ... 600Ω (91h)	---	---	overrange
	0 ... 600Ω	0 ... 6000	nominal range
2 wire: 0 ... 3000Ω (92h)	---	---	underrange
	0 ... 3000Ω	0 ... 30000	nominal range
3 wire: 0 ... 60Ω (98h)	---	---	underrange
	0 ... 60Ω	0 ... 6000	nominal range
3 wire: 0 ... 600Ω (99h)	---	---	overrange
	0 ... 600Ω	0 ... 6000	nominal range
3 wire: 0 ... 3000Ω (9Ah)	---	---	underrange
	0 ... 3000Ω	0 ... 30000	nominal range
4 wire: 0 ... 60Ω (A0h)	---	---	overrange
	0 ... 60Ω	0 ... 6000	nominal range
4 wire: 0 ... 600Ω (A1h)	---	---	underrange
	0 ... 600Ω	0 ... 6000	nominal range
4 wire: 0 ... 3000Ω (A2h)	---	---	underrange
	0 ... 3000Ω	0 ... 30000	nominal range
2 wire: 0 ... 60Ω (D0h)	---	---	overrange
	70.55Ω	32511	overrange
2 wire: 0 ... 600Ω (D1h)	0 ... 60Ω	0 ... 27648	nominal range
	---	---	underrange
2 wire: 0 ... 3000Ω (D2h)	705.5Ω	32511	overrange
	0 ... 600Ω	0 ... 27648	nominal range
2 wire: 0 ... 3000Ω (D2h)	---	---	underrange
	3528Ω	32511	overrange
2 wire: 0 ... 3000Ω (D2h)	0 ... 3000Ω	0 ... 27648	nominal range
	---	---	underrange

Measuring range (funct. no.)	Measuring value	Signal range	Range
3 wire: 0 ... 60Ω (D8h)	70.55Ω	32511	overrange
	0 ... 60Ω	0 ... 27648	nominal range
	---	---	underrange
3 wire: 0 ... 600Ω (D9h)	705.5Ω	32511	overrange
	0 ... 600Ω	0 ... 27648	nominal range
	---	---	underrange
3 wire: 0 ... 3000Ω (DAh)	3528Ω	32511	overrange
	0 ... 3000Ω	0 ... 27648	nominal range
	---	---	underrange
4 wire: 0 ... 60Ω (E0h)	70.55Ω	32511	overrange
	0 ... 60Ω	0 ... 27648	nominal range
	---	---	underrange
4 wire: 0 ... 600Ω (E1h)	705.5Ω	32511	overrange
	0 ... 600Ω	0 ... 27648	nominal range
	---	---	underrange
4 wire: 0 ... 3000Ω (E2h)	3528Ω	32511	overrange
	0 ... 3000Ω	0 ... 27648	nominal range
	---	---	underrange

CHxFO Function option channel x

Depending on the Interference frequency suppression for each channel the transducer velocity may be set.

Code*	Velocity (in ms) / channel at Interference frequency suppression	
	50Hz	60Hz
00h*	324.1	270.5
01h*	164.2	137.2
02h*	84.2	70.5
03h	44.1	37.2
04h	24.2	20.5
05h	14.2	12.2
06h	9.2	8.0
07h	6.6	5.9
08h	4.2	3.8

*) For Code 00h, 01h and 02h the tolerances of the technical data "with interference frequency suppression" are valid.

- CHxUL / CHxLL channel x** For each channel an *upper* and a *lower limit* may be defined. Here only values of the nominal range may be preset, otherwise you receive a parameterization error. By presetting 7FFFh for the upper respectively 8000h for the lower limit value the corresponding limit is deactivated.
- As soon as the measuring value is beyond the limits and the limit value monitoring is activated, a process interrupt is initialized.

3.13.3 Diagnostics and interrupt

Event	Process interrupt	Diagnostics interrupt	parameterizable
Error in project engineering/ parameterization	-	X	-
Wire break	-	X	X
Measuring range overflow	-	X	-
Measuring range underflow	-	X	-
Limit overflow	X	-	X
Limit underflow	X	-	X
Diagnostic buffer overflow	-	X	-
Communication error	-	X	-
Process interrupt lost	-	X	-

Process interrupt

So you may react to asynchronous events, there is the possibility to activate a process interrupt. A process interrupt interrupts the linear program sequence and jumps depending on the master system to a corresponding Interrupt routine. Here you can react to the process interrupt accordingly.

With CANopen the process interrupt data is transferred via an emergency telegram.

Operating with CPU, PROFIBUS and PROFINET the process interrupt data were transferred via diagnostics telegram.

SX - Subindex for access via EtherCAT with Index 5000h

More can be found in the according manual of your bus coupler.

Name	Bytes	Function	Default	SX
PRIT_OL	1	Upper limit overflow channel x	00h	02h
PRIT_UL	1	Lower limit underflow channel x	00h	03h
PRIT_US	2	µs-Ticker	00h	04h (high byte) 05h (low byte)

PRIT_OL Limit overflow

Byte	Bit 7 ... 0
0	Bit 0: Limit overflow channel 0 Bit 1: Limit overflow channel 1 Bit 7 ... 4: reserved

PRIT_UL Limit underflow

Byte	Bit 7 ... 0
0	Bit 0: Limit underflow channel 0 Bit 1: Limit underflow channel 1 Bit 7 ... 4: reserved

PRIT_US μ s ticker

Byte	Bit 7 ... 0
0 ... 1	16bit μ s value at the moment of the interrupt

μ s ticker

In the SLIO module there is a 32 bit timer (μ s ticker). With PowerON the timer starts counting with 0. After $2^{32}-1\mu$ s the timer starts with 0 again. PRIT_US represents the lower 2 byte of the μ s ticker value ($0 \dots 2^{16}-1$).

Diagnostic data

Via the parameterization you may activate a diagnostic interrupt for the module. With a diagnostics interrupt the module serves for diagnostics data for diagnostic interrupt_{incoming}. As soon as the reason for releasing a diagnostic interrupt is no longer present, the diagnostic interrupt_{going} automatically takes place. All events of a channel between diagnostic interrupt_{incoming} and diagnostic interrupt_{going} are not stored and get lost. Within this time window (1. diagnostic interrupt_{incoming} until last diagnostic interrupt_{going}) the MF-LED of the module is on.

DS - Record set for access via CPU, PROFIBUS and PROFINET. The access happens by DS 01h. Additionally the first 4 bytes may be accessed by DS 00h.

IX - Index for access via CANopen. The access happens by IX 2F01h. Additionally the first 4 bytes may be accessed by IX 2F00h.

SX - Subindex for access via EtherCAT with Index 5005h.

More can be found in the according manual of your bus coupler.

Name	Bytes	Function	Default	DS	IX	SX
ERR_A	1	Diagnostic	00h	01h	2F01h	02h
MODTYP	1	Module information	15h			03h
ERR_C	1	reserved	00h			04h
ERR_D	1	Diagnostic	00h			05h
CHTYP	1	Channel type	71h			06h
NUMBIT	1	Number diagnostic bits per channel	08h			07h
NUMCH	1	Number of channels of a module	04h			08h
CHERR	1	Channel error	00h			09h
CH0ERR	1	Channel-specific error channel 0	00h			0Ah

Name	Bytes	Function	Default	DS	IX	SX
CH1ERR	1	Channel-specific error channel 1	00h			0Bh
CH2ERR	1	Channel-specific error channel 2	00h			0Ch
CH3ERR	1	Channel-specific error channel 3	00h			0Dh
CH4ERR... CH7ERR	4	reserved	00h			0Eh...11h
DIAG_US	4	µs ticker	00h			13h

ERR_A Diagnostic

Byte	Bit 7 ... 0
0	<ul style="list-style-type: none"> ■ Bit 0: set at module failure ■ Bit 1: set at internal error ■ Bit 2: set at external error ■ Bit 3: set at channel error ■ Bit 4: set at external auxiliary supply missing ■ Bit 6 ... 5: reserved ■ Bit 7: set at error in parameterization

MODTYP Module information

Byte	Bit 7 ... 0
0	<ul style="list-style-type: none"> ■ Bit 3 ... 0: module class <ul style="list-style-type: none"> – 0101b analog module ■ Bit 4: set at channel information present ■ Bit 7 ... 5: reserved

ERR_D Diagnose

Byte	Bit 7 ... 0
0	<ul style="list-style-type: none"> ■ Bit 2 ... 0: reserved ■ Bit 3: set at internal diagnostics buffer overflow ■ Bit 4: set at internal communication error ■ Bit 5: reserved ■ Bit 6: set at process interrupt lost ■ Bit 7: reserved

CHTYP Channel type

Byte	Bit 7 ... 0
0	<ul style="list-style-type: none"> ■ Bit 6 ... 0: Channel type <ul style="list-style-type: none"> – 70h: Digital input – 71h: Analog input – 72h: Digital output – 73h: Analog output – 74h: Analog input/-output – 76h: Counter ■ Bit 7: reserved

NUMBIT Diagnostic bits

Byte	Bit 7 ... 0
0	Number of diagnostic bits per channel (here 08h)

NUMCH Channels

Byte	Bit 7 ... 0
0	Number of channels of a module (here 04h)

CHERR Channel error

Byte	Bit 7 ... 0
0	<ul style="list-style-type: none"> ■ Bit 0: set at error in channel group 0 ■ Bit 1: set at error in channel group 1 ■ Bit 2: set at error in channel group 2 ■ Bit 3: set at error in channel group 3 ■ Bit 7 ... 4: reserved

**CH0ERR/CH3ERR
Channel-specific**

Byte	Bit 7 ... 0
0	Channel-specific error: channel x: <ul style="list-style-type: none"> ■ Bit 0: set at error in project engineering/parameterization ■ Bit 3 ... 1: reserved ■ Bit 4: set at wire break ■ Bit 5: set at process interrupt lost ■ Bit 6: set at measuring range underflow ■ Bit 7: set at measuring range overflow

**CH4ERR ... CH7ERR
reserved**

Byte	Bit 7 ... 0
0	reserved

DIAG_US μ s ticker

Byte	Bit 7 ... 0
0...3	Value of the μ s ticker at the moment of the diagnostic

 μ s ticker

In the System SLIO module there is a timer (μ s ticker). With PowerON the timer starts counting with 0. After $2^{32}-1\mu$ s the timer starts with 0 again.

3.14 031-1BF60 - AI 8x12Bit 0(4)...20mA

Properties

The electronic module has 8 inputs with parameterizable functions. The channels of the module are isolated to the backplane bus.

- 8 analog single ended inputs (reference potential 0V)
- Suited for sensors with 0(4) ... 20mA with external supply
- Interference frequency suppression parameterizable (50/60Hz)
- Diagnostics function
- 12bit resolution

Structure

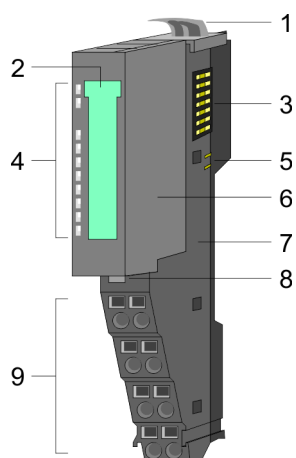

- 1 Locking lever terminal module
- 2 Labeling strip
- 3 Backplane bus
- 4 LED status indication
- 5 DC 24V power section supply
- 6 Electronic module
- 7 Terminal module
- 8 Locking lever electronic module
- 9 Terminal

Status indication

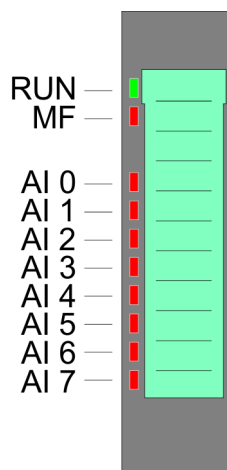

RUN	MF	AI x	Description
<input checked="" type="checkbox"/> green	<input checked="" type="checkbox"/> red	<input checked="" type="checkbox"/> red	
<input checked="" type="checkbox"/>	<input type="checkbox"/>	X	Bus communication is OK Module status is OK
<input checked="" type="checkbox"/>	<input checked="" type="checkbox"/>	X	Bus communication is OK Module status reports an error
<input type="checkbox"/>	<input checked="" type="checkbox"/>	X	Bus communication is not possible Module status reports an error
<input type="checkbox"/>	<input type="checkbox"/>	X	Error at bus power supply
X	<input checked="" type="checkbox"/> 2Hz	X	Error in configuration Chap. 2.8 'Trouble shooting - LEDs' page 30
<input checked="" type="checkbox"/>	<input type="checkbox"/>	<input checked="" type="checkbox"/>	Error channel x <ul style="list-style-type: none"> ■ Signal leaves measuring range ■ Error in parameterization
not relevant: X			

Pin assignment

For wires with a cross section of 0.08mm² up to 1.5mm².

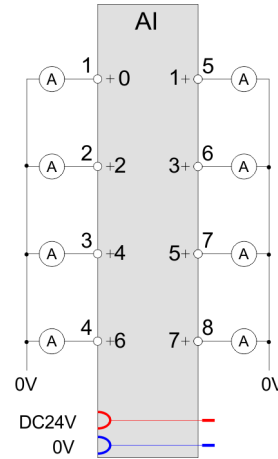
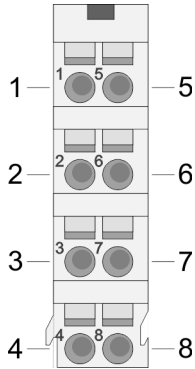

Pos.	Function	Type	Description
1	+AI 0	I	+ Channel 0
2	+AI 2	I	+ Channel 2
3	+AI 4	I	+ Channel 4
4	+AI 6	I	+ Channel 6
5	+AI 1	I	+ Channel 1
6	+AI 3	I	+ Channel 3
7	+AI 5	I	+ Channel 5
8	+AI 7	I	+ Channel 7

I: Input

In-/Output area

At CPU, PROFIBUS and PROFINET the input respectively output area is embedded to the corresponding address area.

IX - Index for access via CANopen with s = Subindex, depends on number and type of analog modules

SX - Subindex for access via EtherCAT with Index 6000h + EtherCAT-Slot

More can be found in the according manual of your bus coupler.

Input area

Addr.	Name	Bytes	Function	IX	SX
+0	AI 0	2	Analog value channel 0	6401h/s	01h
+2	AI 1	2	Analog value channel 1	6401h/s+1	02h
+4	AI 2	2	Analog value channel 2	6401h/s+2	03h
+6	AI 3	2	Analog value channel 3	6401h/s+3	04h
+8	AI 4	2	Analog value channel 4	6401h/s+4	05h
+10	AI 5	2	Analog value channel 5	6401h/s+5	06h

Addr.	Name	Bytes	Function	IX	SX
+12	AI 6	2	Analog value channel 6	6401h/s+6	07h
+14	AI 7	2	Analog value channel 7	6401h/s+7	08h

Output area

No byte of the output area is used by the module.

3.14.1 Technical data

Order no.	031-1BF60
Type	SM 031
Module ID	0416 15C5
Current consumption/power loss	
Current consumption from backplane bus	70 mA
Power loss	1 W
Technical data analog inputs	
Number of inputs	8
Cable length, shielded	200 m
Rated load voltage	DC 24 V
Current consumption from load voltage L+ (without load)	20 mA
Voltage inputs	-
Min. input resistance (voltage range)	-
Input voltage ranges	-
Operational limit of voltage ranges	-
Operational limit of voltage ranges with SFU	-
Basic error limit voltage ranges	-
Basic error limit voltage ranges with SFU	-
Destruction limit voltage	-
Current inputs	✓
Max. input resistance (current range)	60 Ω
Input current ranges	0 mA ... +20 mA +4 mA ... +20 mA
Operational limit of current ranges	+/-0.5%
Operational limit of current ranges with SFU	-
Basic error limit current ranges	+/-0.3%
Radical error limit current ranges with SFU	-
Destruction limit current inputs (voltage)	max. 30V
Destruction limit current inputs (electrical current)	max. 40mA

031-1BF60 - AI 8x12Bit 0(4)...20mA > Technical data

Order no.	031-1BF60
Resistance inputs	-
Resistance ranges	-
Operational limit of resistor ranges	-
Operational limit of resistor ranges with SFU	-
Basic error limit	-
Basic error limit with SFU	-
Destruction limit resistance inputs	-
Resistance thermometer inputs	-
Resistance thermometer ranges	-
Operational limit of resistance thermometer ranges	-
Operational limit of resistance thermometer ranges with SFU	-
Basic error limit thermoresistor ranges	-
Basic error limit thermoresistor ranges with SFU	-
Destruction limit resistance thermometer inputs	-
Thermocouple inputs	-
Thermocouple ranges	-
Operational limit of thermocouple ranges	-
Operational limit of thermocouple ranges with SFU	-
Basic error limit thermoelement ranges	-
Basic error limit thermoelement ranges with SFU	-
Destruction limit thermocouple inputs	-
Programmable temperature compensation	-
External temperature compensation	-
Internal temperature compensation	-
Temperature error internal compensation	-
Technical unit of temperature measurement	-
Resolution in bit	12
Measurement principle	successive approximation
Basic conversion time	2 ms all channels
Noise suppression for frequency	>50dB at 50Hz (UCM<2V)
Status information, alarms, diagnostics	
Status display	yes
Interrupts	no
Process alarm	no
Diagnostic interrupt	no

Order no.	031-1BF60
Diagnostic functions	yes
Diagnostics information read-out	possible
Module state	green LED
Module error display	red LED
Channel error display	red LED per channel
Isolation	
Between channels	-
Between channels of groups to	-
Between channels and backplane bus	✓
Between channels and power supply	-
Max. potential difference between circuits	-
Max. potential difference between inputs (Ucm)	-
Max. potential difference between Mana and Mintern (Uiso)	-
Max. potential difference between inputs and Mana (Ucm)	-
Max. potential difference between inputs and Mintern (Uiso)	DC 75 V/ AC 50 V
Max. potential difference between Mintern and outputs	-
Insulation tested with	DC 500 V
Technical data encoder supply	
Number of outputs	-
Output voltage (typ)	-
Output voltage (rated value)	-
Short-circuit protection	-
Binding of potential	-
Datasizes	
Input bytes	16
Output bytes	0
Parameter bytes	14
Diagnostic bytes	20
Housing	
Material	PPE / PPE GF10
Mounting	Profile rail 35 mm
Mechanical data	
Dimensions (WxHxD)	12.9 mm x 109 mm x 76.5 mm
Net weight	58 g
Weight including accessories	58 g

031-1BF60 - AI 8x12Bit 0(4)...20mA > Parameter data

Order no.	031-1BF60
Gross weight	73 g
Environmental conditions	
Operating temperature	0 °C to 60 °C
Storage temperature	-25 °C to 70 °C
Certifications	
UL certification	yes
KC certification	yes

SFU - Interference frequency suppression

3.14.2 Parameter data

DS - Record set for access via CPU, PROFIBUS and PROFINET

IX - Index for access via CANopen

SX - Subindex for access via EtherCAT with Index 3100h + EtherCAT-Slot

More can be found in the according manual of your bus coupler.

Name	Bytes	Function	Default	DS	IX	SX
SUPR	2	Interference frequency suppression (SFU)	0000h	01h	3100h, 3101h	01h
CH0FN	1	Function number channel 0	31h	80h	3102h	02h
CH1FN	1	Function number channel 1	31h	81h	3103h	03h
CH2FN	1	Function number channel 2	31h	82h	3104h	04h
CH3FN	1	Function number channel 3	31h	83h	3105h	05h
CH4FN	1	Function number channel 4	31h	84h	3106h	06h
CH5FN	1	Function number channel 5	31h	85h	3107h	07h
CH6FN	1	Function number channel 6	31h	86h	3108h	08h
CH7FN	1	Function number channel 7	31h	87h	3109h	09h

SUPR Interference frequency suppression (SFU)

Byte	Bit 15 ... 0
0	<ul style="list-style-type: none"> ■ Bit 0, 1: Interference frequency suppression channel 0 ■ Bit 2, 3: Interference frequency suppression channel 1 ■ Bit 4, 5: Interference frequency suppression channel 2 ■ Bit 6, 7: Interference frequency suppression channel 3 ■ Bit 8, 9: Interference frequency suppression channel 4 ■ Bit 10, 11: Interference frequency suppression channel 5 ■ Bit 12, 13: Interference frequency suppression channel 6 ■ Bit 14, 15: Interference frequency suppression channel 7 <ul style="list-style-type: none"> – 00: deactivated – 01: 60Hz – 10: 50Hz

CHxFN Function number channel x

In the following there are the measuring ranges with corresponding function number listed, which were supported by the analog module. With FFh the corresponding channel is deactivated. The formulas listed here allow you to transform an evaluated measuring value (digital value) to a value assigned to the measuring range (analog value) and vice versa.

0(4) ... 20mA

Meas. range (funct. no.)	Current (I)	Decimal (D)	Hex	Range	Formulas
0 ... 20mA Siemens S7 format (31h)	23.52mA	32511	7EFFh	overrange	$D = 27648 \cdot \frac{I}{20}$ $I = D \cdot \frac{20}{27648}$
	20mA	27648	6C00h	nominal range	
	10mA	13824	3600h		
	0mA	0	0000h		
	-3.52mA	-4864	ED00h	underrange	
0 ... 20mA Siemens S5 format (41h)	25.00mA	20480	5000h	overrange	$D = 16384 \cdot \frac{I}{20}$ $I = D \cdot \frac{20}{16384}$
	20mA	16384	4000h	nominal range	
	10mA	8192	2000h		
	0mA	0	0000h		
	-4,00mA	-3277	F333h	underrange	
4 ... 20mA Siemens S7 format (30h)	22.81mA	32511	7EFFh	overrange	$D = 27648 \cdot \frac{I-4}{16}$ $I = D \cdot \frac{16}{27648} + 4$
	20mA	27648	6C00h	nominal range	
	12mA	13824	3600h		
	4mA	0	0000h		
	1.19mA	-4864	ED00h	underrange	
4 ... 20mA Siemens S5 format (40h)	24.00mA	20480	5000h	overrange	$D = 16384 \cdot \frac{I-4}{16}$ $I = D \cdot \frac{16}{16384} + 4$
	20mA	16384	4000h	nominal range	
	12mA	8192	2000h		
	4mA	0	0000h		
	0.8mA	-3277	F333h	underrange	

3.14.3 Diagnostic data

So this module does not support diagnostic interrupt functions, the diagnostics data serve for information about this module. On error the corresponding channel LED of the module is activated and the error is registered in the diagnostics data.

The following errors are listed in the diagnostics data:

- Error in project engineering / parameterization
- Measuring range overflow
- Measuring range underflow

DS - Record set for access via CPU, PROFIBUS and PROFINET. The access happens by DS 01h. Additionally the first 4 bytes may be accessed by DS 00h.

IX - Index for access via CANopen. The access happens by IX 2F01h. Additionally the first 4 bytes may be accessed by IX 2F00h.

SX - Subindex for access via EtherCAT with Index 5005h.

More can be found in the according manual of your bus coupler.

Name	Bytes	Function	Default	DS	IX	SX
ERR_A	1	Diagnostic	00h	01h	2F01h	02h
MODTYP	1	Module information	15h			03h
ERR_C	1	reserved	00h			04h
ERR_D	1	Diagnostic	00h			05h
CHTYP	1	Channel type	71h			06h
NUMBIT	1	Number diagnostic bits per channel	08h			07h
NUMCH	1	Number of channels of a module	08h			08h
CHERR	1	Channel error	00h			09h
CH0ERR	1	Channel-specific error channel 0	00h			0Ah
CH1ERR	1	Channel-specific error channel 1	00h			0Bh
CH2ERR	1	Channel-specific error channel 2	00h			0Ch
CH3ERR	1	Channel-specific error channel 3	00h			0Dh
CH4ERR	1	Channel-specific error channel 4	00h			0Eh
CH5ERR	1	Channel-specific error channel 5	00h			0Fh
CH6ERR	1	Channel-specific error channel 6	00h			10h
CH7ERR	1	Channel-specific error channel 7	00h			11h
DIAG_US	4	µs ticker	00h			13h

ERR_A Diagnostic

Byte	Bit 7 ... 0
0	<ul style="list-style-type: none"> ■ Bit 0: set at module failure ■ Bit 1: set at internal error ■ Bit 2: set at external error ■ Bit 3: set at channel error ■ Bit 4: set at external auxiliary supply missing ■ Bit 6 ... 5: reserved ■ Bit 7: set at error in parameterization

MODTYP Module information

Byte	Bit 7 ... 0
0	<ul style="list-style-type: none"> ■ Bit 3 ... 0: module class <ul style="list-style-type: none"> – 0101b analog module ■ Bit 4: set at channel information present ■ Bit 7 ... 5: reserved

ERR_D Diagnostic

Byte	Bit 7 ... 0
0	<ul style="list-style-type: none"> ■ Bit 3 ... 0: reserved ■ Bit 4: set at internal communication error ■ Bit 7 ... 5: reserved

CHTYP Channel type

Byte	Bit 7 ... 0
0	<ul style="list-style-type: none"> ■ Bit 6 ... 0: Channel type <ul style="list-style-type: none"> – 70h: Digital input – 71h: Analog input – 72h: Digital output – 73h: Analog output – 74h: Analog input/output – 76h: Counter ■ Bit 7: reserved

NUMBIT Diagnostic bits

Byte	Bit 7 ... 0
0	Number of diagnostic bits per channel (here 08h)

NUMCH Channels

Byte	Bit 7 ... 0
0	Number of channels of a module (here 08h)

031-1BF60 - AI 8x12Bit 0(4)...20mA > Diagnostic data

CHERR Channel error

Byte	Bit 7 ... 0
0	<ul style="list-style-type: none"> ■ Bit 0: set at error in channel 0 ■ Bit 1: set at error in channel 1 ■ Bit 2: set at error in channel 2 ■ Bit 3: set at error in channel 3 ■ Bit 4: set at error in channel 4 ■ Bit 5: set at error in channel 5 ■ Bit 6: set at error in channel 6 ■ Bit 7: set at error in channel 7

**CH0ERR ... CH7ERR
Channel-specific**

Byte	Bit 7 ... 0
0	Channel-specific error channel x: <ul style="list-style-type: none"> ■ Bit 0: set at configuring-/parameter assignment error ■ Bit 5 ... 1: reserved ■ Bit 6: set at measuring range underflow ■ Bit 7: set at measuring range overflow

DIAG_US μ s ticker

Byte	Bit 7 ... 0
0...3	Value of the μ s ticker at the moment of the diagnostic

 μ s ticker

In the System SLIO module there is a timer (μ s ticker). With PowerON the timer starts counting with 0. After $2^{32}-1\mu$ s the timer starts with 0 again.

3.15 031-1BF74 - AI 8x12Bit ±10V

Properties

The electronic module has 8 inputs with parameterizable functions. The channels of the module are electrically isolated from the backplane bus.

- 8 analog single ended inputs (reference potential 0V)
- Suited for sensors with ±10V, 0 ... 10V with external supply
- Interference frequency suppression parameterizable (50/60Hz)
- Diagnostics function
- 12bit resolution

Structure

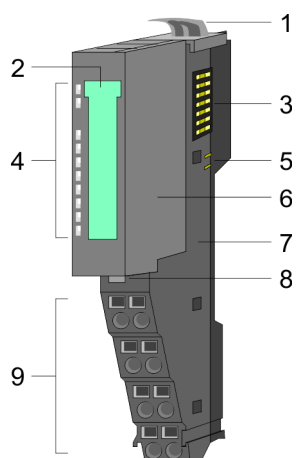

- 1 Locking lever terminal module
- 2 Labeling strip
- 3 Backplane bus
- 4 LED status indication
- 5 DC 24V power section supply
- 6 Electronic module
- 7 Terminal module
- 8 Locking lever electronic module
- 9 Terminal

Status indication

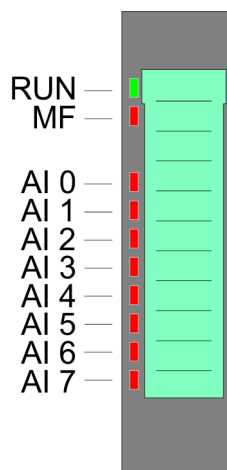

RUN	MF	AI x	Description
<input checked="" type="checkbox"/> green	<input checked="" type="checkbox"/> red	<input checked="" type="checkbox"/> red	
<input checked="" type="checkbox"/>	<input type="checkbox"/>	X	Bus communication is OK Module status is OK
<input checked="" type="checkbox"/>	<input checked="" type="checkbox"/>	X	Bus communication is OK Module status reports an error
<input type="checkbox"/>	<input checked="" type="checkbox"/>	X	Bus communication is not possible Module status reports an error
<input type="checkbox"/>	<input type="checkbox"/>	X	Error at bus power supply
X	<input checked="" type="checkbox"/> 2Hz	X	Error in configuration ↗ <i>Chap. 2.8 'Trouble shooting - LEDs' page 30</i>
<input checked="" type="checkbox"/>	<input type="checkbox"/>	<input checked="" type="checkbox"/>	Error channel x <ul style="list-style-type: none"> ■ Signal leaves measuring range ■ Error in parameterization
not relevant: X			

031-1BF74 - AI 8x12Bit ±10V

Pin assignment

For wires with a cross section of 0.08mm² up to 1.5mm².

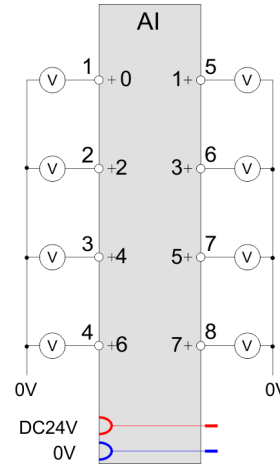
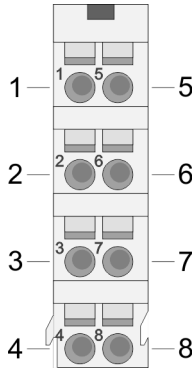

Pos.	Function	Type	Description
1	+AI 0	I	+ Channel 0
2	+AI 2	I	+ Channel 2
3	+AI 4	I	+ Channel 4
4	+AI 6	I	+ Channel 6
5	+AI 1	I	+ Channel 1
6	+AI 3	I	+ Channel 3
7	+AI 5	I	+ Channel 5
8	+AI 7	I	+ Channel 7

I: Input

In-/Output area

At CPU, PROFIBUS and PROFINET the input respectively output area is embedded to the corresponding address area.

IX - Index for access via CANopen with s = Subindex, depends on number and type of analog modules

SX - Subindex for access via EtherCAT with Index 6000h + EtherCAT-Slot

More can be found in the according manual of your bus coupler.

Input area

Addr.	Name	Bytes	Function	IX	SX
+0	AI 0	2	Analog value channel 0	6401h/s	01h
+2	AI 1	2	Analog value channel 1	6401h/s+1	02h
+4	AI 2	2	Analog value channel 2	6401h/s+2	03h
+6	AI 3	2	Analog value channel 3	6401h/s+3	04h
+8	AI 4	2	Analog value channel 4	6401h/s+4	05h
+10	AI 5	2	Analog value channel 5	6401h/s+5	06h

Addr.	Name	Bytes	Function	IX	SX
+12	AI 6	2	Analog value channel 6	6401h/s+6	07h
+14	AI 7	2	Analog value channel 7	6401h/s+7	08h

Output area

No byte of the output area is used by the module.

3.15.1 Technical data

Order no.	031-1BF74
Type	SM 031
Module ID	0415 15C5
Current consumption/power loss	
Current consumption from backplane bus	70 mA
Power loss	0.8 W
Technical data analog inputs	
Number of inputs	8
Cable length, shielded	200 m
Rated load voltage	DC 24 V
Current consumption from load voltage L+ (without load)	20 mA
Voltage inputs	✓
Min. input resistance (voltage range)	100 k Ω
Input voltage ranges	0 V ... +10 V -10 V ... +10 V
Operational limit of voltage ranges	-
Operational limit of voltage ranges with SFU	-
Basic error limit voltage ranges	-
Basic error limit voltage ranges with SFU	-
Destruction limit voltage	max. 30V
Current inputs	-
Max. input resistance (current range)	-
Input current ranges	-
Operational limit of current ranges	-
Operational limit of current ranges with SFU	-
Basic error limit current ranges	-
Radical error limit current ranges with SFU	-
Destruction limit current inputs (voltage)	-
Destruction limit current inputs (electrical current)	-

031-1BF74 - AI 8x12Bit $\pm 10V$ > Technical data

Order no.	031-1BF74
Resistance inputs	-
Resistance ranges	-
Operational limit of resistor ranges	-
Operational limit of resistor ranges with SFU	-
Basic error limit	-
Basic error limit with SFU	-
Destruction limit resistance inputs	-
Resistance thermometer inputs	-
Resistance thermometer ranges	-
Operational limit of resistance thermometer ranges	-
Operational limit of resistance thermometer ranges with SFU	-
Basic error limit thermoresistor ranges	-
Basic error limit thermoresistor ranges with SFU	-
Destruction limit resistance thermometer inputs	-
Thermocouple inputs	-
Thermocouple ranges	-
Operational limit of thermocouple ranges	-
Operational limit of thermocouple ranges with SFU	-
Basic error limit thermoelement ranges	-
Basic error limit thermoelement ranges with SFU	-
Destruction limit thermocouple inputs	-
Programmable temperature compensation	-
External temperature compensation	-
Internal temperature compensation	-
Temperature error internal compensation	-
Technical unit of temperature measurement	-
Resolution in bit	12
Measurement principle	successive approximation
Basic conversion time	1 ms all channels
Noise suppression for frequency	>50dB at 50Hz (UCM<2V)
Status information, alarms, diagnostics	
Status display	yes
Interrupts	no
Process alarm	no
Diagnostic interrupt	no

Order no.	031-1BF74
Diagnostic functions	yes
Diagnostics information read-out	possible
Module state	green LED
Module error display	red LED
Channel error display	red LED per channel
Isolation	
Between channels	-
Between channels of groups to	-
Between channels and backplane bus	✓
Between channels and power supply	-
Max. potential difference between circuits	-
Max. potential difference between inputs (Ucm)	-
Max. potential difference between Mana and Mintern (Uiso)	-
Max. potential difference between inputs and Mana (Ucm)	-
Max. potential difference between inputs and Mintern (Uiso)	DC 75 V/ AC 50 V
Max. potential difference between Mintern and outputs	-
Insulation tested with	DC 500 V
Technical data encoder supply	
Number of outputs	-
Output voltage (typ)	-
Output voltage (rated value)	-
Short-circuit protection	-
Binding of potential	-
Datasizes	
Input bytes	16
Output bytes	0
Parameter bytes	14
Diagnostic bytes	20
Housing	
Material	PPE / PPE GF10
Mounting	Profile rail 35 mm
Mechanical data	
Dimensions (WxHxD)	12.9 mm x 109 mm x 76.5 mm
Net weight	57 g
Weight including accessories	57 g

031-1BF74 - AI 8x12Bit $\pm 10V$ > Parameter data

Order no.	031-1BF74
Gross weight	72 g
Environmental conditions	
Operating temperature	0 °C to 60 °C
Storage temperature	-25 °C to 70 °C
Certifications	
UL certification	yes
KC certification	yes

SFU - Interference frequency suppression

3.15.2 Parameter data

DS - Record set for access via CPU, PROFIBUS and PROFINET

IX - Index for access via CANopen

SX - Subindex for access via EtherCAT with Index 3100h + EtherCAT-Slot

More can be found in the according manual of your bus coupler.

Name	Bytes	Function	Default	DS	IX	SX
SUPR	2	Interference frequency suppression (SFU)	0000h	01h	3100h, 3101h	01h
CH0FN	1	Function number channel 0	12h	80h	3102h	02h
CH1FN	1	Function number channel 1	12h	81h	3103h	03h
CH2FN	1	Function number channel 2	12h	82h	3104h	04h
CH3FN	1	Function number channel 3	12h	83h	3105h	05h
CH4FN	1	Function number channel 4	12h	84h	3106h	06h
CH5FN	1	Function number channel 5	12h	85h	3107h	07h
CH6FN	1	Function number channel 6	12h	86h	3108h	08h
CH7FN	1	Function number channel 7	12h	87h	3109h	09h

SUPR Interference frequency suppression (SFU)

Byte	Bit 15 ... 0
0	<ul style="list-style-type: none"> ■ Bit 0, 1: Interference frequency suppression channel 0 ■ Bit 2, 3: Interference frequency suppression channel 1 ■ Bit 4, 5: Interference frequency suppression channel 2 ■ Bit 6, 7: Interference frequency suppression channel 3 ■ Bit 8, 9: Interference frequency suppression channel 4 ■ Bit 10, 11: Interference frequency suppression channel 5 ■ Bit 12, 13: Interference frequency suppression channel 6 ■ Bit 14, 15: Interference frequency suppression channel 7 <ul style="list-style-type: none"> – 00: deactivated – 01: 60Hz – 10: 50Hz

CHxFN Function number channel x

In the following there are the measuring ranges with corresponding function number listed, which were supported by the analog module. With FFh the corresponding channel is deactivated. The formulas listed here allow you to transform an evaluated measuring value (digital value) to a value assigned to the measuring range (analog value) and vice versa.

±10V

Meas. range (funct. no.)	Voltage (U)	Decimal (D)	Hex	Range	Formulas
±10V Siemens S7 format (12h)	11.76V	32511	7EFFh	overrange	$D = 27648 \cdot \frac{U}{10}$ $U = D \cdot \frac{10}{27648}$
	10V	27648	6C00h	nominal range	
	5V	13824	3600h		
	0V	0	0000h		
	-5V	-13824	CA00h		
	-10V	-27648	9400h	underrange	
	-11.76V	-32512	8100h		
±10V Siemens S5 format (22h)	12.5V	20480	5000h	overrange	$D = 16384 \cdot \frac{U}{10}$ $U = D \cdot \frac{10}{16384}$
	10V	16384	4000h	nominal range	
	5V	8192	2000h		
	0V	0	0000h		
	-5V	-8192	E000h		
	-10V	-16384	C000h		
	-12.5V	-20480	B000h		

0 ... 10V

Meas. range (funct. no.)	Voltage (U)	Decimal (D)	Hex	Range	Formulas
0 ... 10V Siemens S7 format (10h)	11.76V	32511	7EFFh	overrange	$D = 27648 \cdot \frac{U}{10}$ $U = D \cdot \frac{10}{27648}$
	10V	27648	6C00h	nominal range	
	5V	13824	3600h		
	0V	0	0000h		
	-1.76V	-4864	ED00h	underrange	
0 ... 10V Siemens S5 format (20h)	12.5V	20480	5000h	overrange	$D = 16384 \cdot \frac{U}{10}$ $U = D \cdot \frac{10}{16384}$
	10V	16384	4000h	nominal range	
	5V	8192	2000h		
	0V	0	0000h		
	-2V	-3277	F333h	underrange	

3.15.3 Diagnostic data

So this module does not support diagnostic interrupt functions, the diagnostics data serve for information about this module. On error the corresponding channel LED of the module is activated and the error is registered in the diagnostics data.

The following errors are listed in the diagnostics data:

- Error in project engineering / parameterization
- Measuring range overflow
- Measuring range underflow

DS - Record set for access via CPU, PROFIBUS and PROFINET. The access happens by DS 01h. Additionally the first 4 bytes may be accessed by DS 00h.

IX - Index for access via CANopen. The access happens by IX 2F01h. Additionally the first 4 bytes may be accessed by IX 2F00h.

SX - Subindex for access via EtherCAT with Index 5005h.

More can be found in the according manual of your bus coupler.

Name	Bytes	Function	Default	DS	IX	SX
ERR_A	1	Diagnostic	00h	01h	2F01h	02h
MODTYP	1	Module information	15h			03h
ERR_C	1	reserved	00h			04h
ERR_D	1	Diagnostic	00h			05h
CHTYP	1	Channel type	71h			06h
NUMBIT	1	Number diagnostic bits per channel	08h			07h
NUMCH	1	Number of channels of a module	08h			08h
CHERR	1	Channel error	00h			09h

Name	Bytes	Function	Default	DS	IX	SX
CH0ERR	1	Channel-specific error channel 0	00h			0Ah
CH1ERR	1	Channel-specific error channel 1	00h			0Bh
CH2ERR	1	Channel-specific error channel 2	00h			0Ch
CH3ERR	1	Channel-specific error channel 3	00h			0Dh
CH4ERR	1	Channel-specific error channel 4	00h			0Eh
CH5ERR	1	Channel-specific error channel 5	00h			0Fh
CH6ERR	1	Channel-specific error channel 6	00h			10h
CH7ERR	1	Channel-specific error channel 7	00h			11h
DIAG_US	4	μ s ticker	00h			13h

ERR_A Diagnostic

Byte	Bit 7 ... 0
0	<ul style="list-style-type: none"> ■ Bit 0: set at module failure ■ Bit 1: set at internal error ■ Bit 2: set at external error ■ Bit 3: set at channel error ■ Bit 4: set at external auxiliary supply missing ■ Bit 6 ... 5: reserved ■ Bit 7: set at error in parameterization

MODTYP Module information

Byte	Bit 7 ... 0
0	<ul style="list-style-type: none"> ■ Bit 3 ... 0: module class <ul style="list-style-type: none"> – 0101b analog module ■ Bit 4: set at channel information present ■ Bit 7 ... 5: reserved

ERR_D Diagnostic

Byte	Bit 7 ... 0
0	<ul style="list-style-type: none"> ■ Bit 3 ... 0: reserved ■ Bit 4: set at internal communication error ■ Bit 7 ... 5: reserved

CHTYP Channel type

Byte	Bit 7 ... 0
0	<ul style="list-style-type: none"> ■ Bit 6 ... 0: Channel type <ul style="list-style-type: none"> – 70h: Digital input – 71h: Analog input – 72h: Digital output – 73h: Analog output – 74h: Analog input/output – 76h: Counter ■ Bit 7: reserved

031-1BF74 - AI 8x12Bit $\pm 10V$ > Diagnostic data**NUMBIT Diagnostic bits**

Byte	Bit 7 ... 0
0	Number of diagnostic bits per channel (here 08h)

NUMCH Channels

Byte	Bit 7 ... 0
0	Number of channels of a module (here 08h)

CHERR Channel error

Byte	Bit 7 ... 0
0	<ul style="list-style-type: none"> ■ Bit 0: set at error in channel 0 ■ Bit 1: set at error in channel 1 ■ Bit 2: set at error in channel 2 ■ Bit 3: set at error in channel 3 ■ Bit 4: set at error in channel 4 ■ Bit 5: set at error in channel 5 ■ Bit 6: set at error in channel 6 ■ Bit 7: set at error in channel 7

**CH0ERR ... CH7ERR
Channel-specific**

Byte	Bit 7 ... 0
0	Channel-specific error channel x: <ul style="list-style-type: none"> ■ Bit 0: set at configuring-/parameter assignment error ■ Bit 5 ... 1: reserved ■ Bit 6: set at measuring range underflow ■ Bit 7: set at measuring range overflow

DIAG_US μ s ticker

Byte	Bit 7 ... 0
0...3	Value of the μ s ticker at the moment of the diagnostic

 μ s ticker

In the System SLIO module there is a timer (μ s ticker). With PowerON the timer starts counting with 0. After $2^{32}-1\mu$ s the timer starts with 0 again.

3.16 031-1CA20 - AI 1x16(24)Bit Strain gauge (DMS)

Properties

The electronic module has one channel and is suited to connect it to a strain gauge DMS sensor in load cells, force transducer and torque measuring shaft. The module has a configurable input filter and supports diagnostic interrupt.

- 1-channel for connecting a full bridge
- Absolute accuracy (basic error $\pm 0.1\%$)
- Manual calibration (zero and load adjustment)
- Configurable self-calibration (offset and gain error)
- Fast measurement by high signal bandwidth (ADC with 4 kHz limit frequency)
- Parametrizable IIR filter (300 μ s - 3.6s or dynamic)
- Parametrizable 50/60 Hz rejection
- Programmable power supply for the load cell(s) / full bridge(s)
- Parallel operation of load cells possible
- Diagnostic function
- 16bit resolution (24bit internal)

Structure

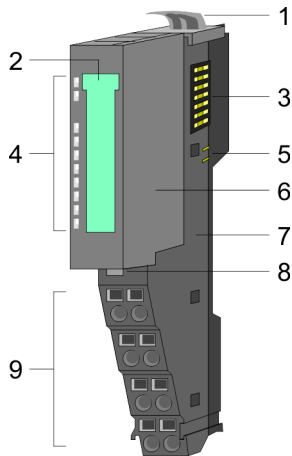

- 1 Locking lever terminal module
- 2 Labeling strip
- 3 Backplane bus
- 4 LED status indication
- 5 DC 24V power section supply
- 6 Electronic module
- 7 Terminal module
- 8 Locking lever electronic module
- 9 Terminal

Status indication

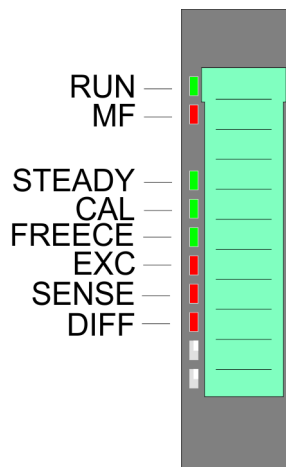

RUN	MF	Description
<input checked="" type="checkbox"/> green	<input checked="" type="checkbox"/> red	
<input checked="" type="checkbox"/>	<input type="checkbox"/>	Bus communication is OK Module status is OK
<input checked="" type="checkbox"/>	<input checked="" type="checkbox"/>	Bus communication is OK Module status reports an error
<input type="checkbox"/>	<input checked="" type="checkbox"/>	Bus communication is not possible Module status reports an error
<input type="checkbox"/>	<input type="checkbox"/>	Error at bus power supply
X	<input checked="" type="checkbox"/> 2Hz	Error in configuration Chap. 2.8 'Trouble shooting - LEDs' page 30
not relevant: X		

031-1CA20 - AI 1x16(24)Bit Strain gauge (DMS)

STEADY ■ green	CAL ■ green	FREEZE ■ green	EXC ■ red	SENSE ■ red	DIFF ■ red	Description
■	X	X	X	X	X	On in <i>Steady State</i> .
X	■	X	X	X	X	On at active self-calibration
X	X	■	X	X	X	On at activated <i>Input-Freeze</i> .
X	X	X	■	X	X	On at short circuit respectively over- load of the excitation voltage.
X	X	X	X	■	X	On at overrange of the excitation voltage
X	X	X	X	X	■	On at overrange of the differential voltage
not relevant: X						

Pin assignment

For wires with a core cross-section of 0.08mm² up to 1.5mm².

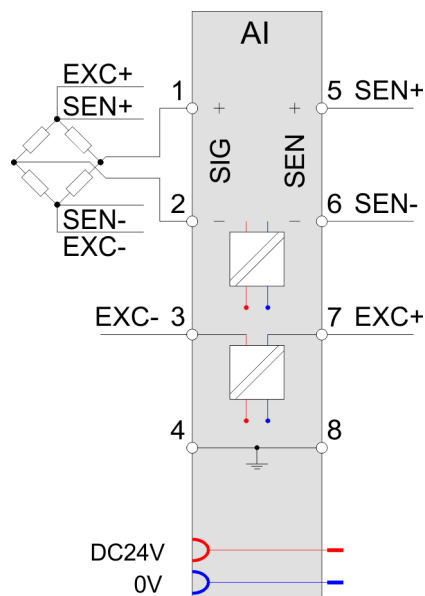
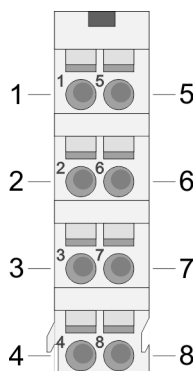

Pos.	Function	Type	Description
1	SIG+	I	+ Signal of the differential voltage U_{SIG} of the measuring bridge
2	SIG-	I	- Signal of the differential voltage U_{SIG} of the measuring bridge
3	EXC-	O	- Signal of the excitation voltage U_{EXC}
4	Shield	---	Connection for cable shield
5	SEN+	I	+ Sensor of the excitation voltage U_{SEN}
6	SEN-	I	- Sensor of the excitation voltage U_{SEN}
7	EXC+	O	+ Signal of the excitation voltage U_{EXC}
8	Shield	---	Connection for cable shield

O: Output, I: Input



Please always use the excitation voltage U_{EXC} of the module! The connection of sensors with external power supply is not possible.

3.16.1 Connection variants

6 wire measurement

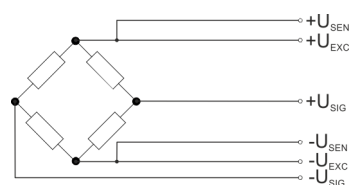

The following table shows the properties of the sensors, which can be used with the 6 wire measurement.

Sensor properties

Excitation voltage U_{EXC}	Bridge resistance R_B			
	120Ω	350Ω	700Ω	1000Ω
2.5V	X	X	X	X
5V	X	X	X	X
7.5V	X	X	X	X
10V	X	X	X	X
12V	X	X	X	X

4 wire measurement

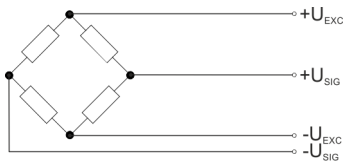

With the 4 wire measurement the U_{SEN} pins are not connected. With this operating mode there is an internal connection between U_{EXC} and U_{SEN} .

The following table shows the properties of the sensors, which can be used with the 4 wire measurement.

Sensor properties

Excitation voltage U_{EXC}	Bridge resistance R_B			
	120Ω	350Ω	700Ω	1000Ω
2.5V	X	X	X	X
5V	X	X	X	X
7.5V	X	X	X	X
10V	X	X	X	X
12V	X	X	X	X

Parallel connection

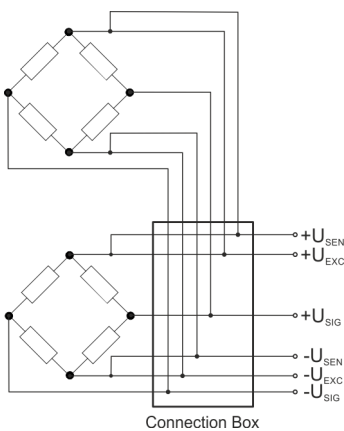

Normally large mechanical loads are divided to multiple strain gauge DMS load cells and these parallel connected via a connection box to the strain gauge DMS module. Please consider that the load cells are aligned together for this operating mode and approved by the manufacturer. And the current feed capacity of the transducer electronic should not be overloaded. The current feed capacity is derived from the number of parallel-connected load cells, excitation voltage U_{EXC} and the bridge resistance.

Depending on the excitation voltage U_{EXC} , I_{EXC} may not exceed a maximum current:

- 2.5V: maximum current 120mA
- 5V: maximum current 120mA
- 7.5V: maximum current 100mA
- 10V: maximum current 90mA
- 12V: maximum current 80mA

For the calculation of I_{EXC} the following formula is used:

$$I_{EXC} = \frac{U_{EXC}}{\frac{R_B}{n}}$$

I_{EXC} Supply current
 U_{EXC} Excitation voltage
 R_B Bridge resistance
 n Number of parallel connections

The following tables show the properties of the sensors for e.g. 2 respectively 3 parallel connected load cells.

Example

2 parallel	Bridge resistance R_B			
Excitation voltage U_{EXC}	60Ω	175Ω	350Ω	500Ω
2.5V	X	X	X	X
5V	X	X	X	X
7.5V	not possible	X	X	X
10V	not possible	X	X	X
12V	not possible	X	X	X

3 parallel	Bridge resistance R_B			
Excitation voltage U_{EXC}	40Ω	116.7Ω	233.3Ω	333.3Ω
2.5V	X	X	X	X
5V	not possible	X	X	X
7.5V	not possible	X	X	X
10V	not possible	X	X	X
12V	not possible	not possible	X	X



To connect your sensors please always use shielded cables!

Please always use the excitation voltage U_{EXC} of the module! The connection of sensors with external power supply is not possible.

3.16.2 In-/Output area

In-/Output area

At CPU, PROFIBUS and PROFINET the input respectively output area is embedded to the corresponding address area.

IX - Index for access via CANopen with s = Subindex, depends on number and type of analog modules

SX - Subindex for access via EtherCAT with Index 6000h/7000h + EtherCAT-Slot

More can be found in the according manual of your bus coupler.

Input area

Addr.	Name	Bytes	Function	IX	SX
+0	DMS_VAL	4	Measured value	5470h/s	01h
+3	DMS_STAT	1	Status	5471h/s	02h

DMS_VAL measured value (weight value)

	Byte 0								Byte 1							
Bit number	31	30	29	28	27	26	25	24	23	22	21	20	19	18	17	16
Significance	SG	2 ³⁰	2 ²⁹	2 ²⁸	2 ²⁷	2 ²⁶	2 ²⁵	2 ²⁴	2 ²³	2 ²²	2 ²¹	2 ²⁰	2 ¹⁹	2 ¹⁸	2 ¹⁷	2 ¹⁶
31Bit+SG	SG	Measured value ...														

	Byte 2								Byte 3							
Bit number	15	14	13	12	11	10	9	8	7	6	5	4	3	2	1	0
Significance	2 ¹⁵	2 ¹⁴	2 ¹³	2 ¹²	2 ¹¹	2 ¹⁰	2 ⁹	2 ⁸	2 ⁷	2 ⁶	2 ⁵	2 ⁴	2 ³	2 ²	2 ¹	2 ⁰
31Bit+SG	... Measured value															

DMS_STAT Status

Addr.	Name	Bytes	Function
+3	DMS_STAT	1	<ul style="list-style-type: none"> ■ Status byte <ul style="list-style-type: none"> – Bit 0: 1 = <i>Input Freeze</i> active – Bit 1: 1 = <i>Steady State</i> active * – Bit 2: 1 = Self-calibration is running * – Bit 3: 1 = Tara was changed – Bit 4: 1 = Error in adjustment – Bit 5: 1 = Adjustment was changed – Bit 6: reserved – Bit 7: 1 = Zero balance respectively reference point set

*) These status bits are set by internal event of the module.

- Input Freeze
 - In the activated state no measurement values are passed to the digital filter.
 - As long as the command bit is set, this bit remains set.
- Steady State
 - As soon as a measured value is longer than the time *SSW* within the tolerance window *SST*, in the status word the *Steady State* bit is set.
 - As soon as this condition is not true, the last measured value is first used, the comparison timer restarted and the bit is reset.
 - The values *SSW* and *SST* can be specified by the parametrization. ↪ *Chap. 3.16.5 'Parameter data' page 186*
- Self calibration
 - As long as the self calibration is active, this bit is set.
 - During the self calibration there are two reference values internally measured and based on this the internal offset & factor are calculated.
 - With the self calibration the internal offset and gain error may be compensated.
 - The calibration interval *CI* can be preset by the parametrization.

- Tara
 - When setting or clearing the tare value, this bit is set.
 - As long as the corresponding command bit is set, this bit remains set.
- Adjustment
 - When you save or delete the adjustment data, this bit is set.
 - As long as the corresponding command bit is set, this bit remains set.
- Zero balance respectively reference point
 - When setting the zero balance respectively reference point this bit is set.
 - As long as the corresponding command bit is set, this bit remains set.

Output area

Addr.	Name	Bytes	Function	IX	SX
+0	DMS_CMD	1	Command byte	5670h/s	01h

DMS_CMD

Addr.	Name	Bytes	Function
+0	DMS_CMD	1	<ul style="list-style-type: none"> ■ Command byte Each set bit in DMS_CMD is acknowledged by a bit in DMS_STAT. <ul style="list-style-type: none"> – Bit 0: Activate <i>Input Freeze</i> → DMS_STAT bit 0: active – Bit 1: Store adjustment → DMS_STAT bit 5: active – Bit 2: Delete adjustment → DMS_STAT bit 5: active – Bit 3: Set <i>Tara</i> → DMS_STAT bit 3: active – Bit 4: Delete <i>Tara</i> → DMS_STAT bit 3: active – Bit 5: reserved – Bit 6: Set zero point → DMS_STAT bit 7: active – Bit 7: Set reference point → DMS_STAT bit 7: active

- Input Freeze
 - In the activated state no measurement values are passed to the digital filter.
 - By a brief activation of *Input Freeze* pulses, e.g. caused by a filling procedure can be prevented, which would override the filter unnecessarily.
 - The status of *Input Freeze* can be determined at any time via bit 0 of DMS_STAT.
- Adjustment
 - Store adjustment: Used to store the adjustment data when loaded with the reference weight.
 - Delete adjustment: Used to delete the adjustment data.
 - With both commands bit 5 of DMS_STAT is set. In case of error bit 4 is set.
- Tara
 - Set Tara: The current value is taken as tara.
 - Delete Tara: Tara is reset to 0.
 - With both commands bit 3 of DMS_STAT is set.
- Zero balance respectively reference point
 - Both commands are used for user adjustment and on both commands bit 7 of DMS_STAT is set.
 - Set zero balance: Used to set the balance to 0 when operated without load.
 - Set reference point: Used to adjust the balance when it is loaded with a reference weight.

3.16.3 Technical data

Order no.	031-1CA20
Type	SM 031
Module ID	0841 1809
Current consumption/power loss	
Current consumption from backplane bus	55 mA
Power loss	1 W
Technical data strain gauge DMS inputs	
Number of inputs	1
Cable length, shielded	200 m
Rated load voltage	DC 24 V
Reverse polarity protection of rated load voltage	✓
Current consumption from load voltage L+ (without load)	18 mA
Relative accuracy according to self-calibration	+/-0.01%
Operational limit Usense	+/-0.2%
Operational limit Usig	+/-0.2%
Basic error limit Usense	+/-0.1%
Basic error limit Usig	+/-0.1%
Destruction limit voltage	max. 12V
External bridge supply possible	-
Internal bridge supply possible	✓
Configurable bridge supply	2.5V / max. 120mA 5V / max. 120mA 7.5V / max. 100mA 10V / max. 90mA 12V / max. 80mA
Resolution in bit	24
Measurement principle	successive approximation
Basic conversion time	1ms cycle, 10ms...330ms depending on the filter
Input filter Hardware	Low pass 10kHz 3rd order
Input filter software	Dynamic IIR filter configurable IIR filter 0.1Hz...1000Hz configurable FIR filter 50Hz/60Hz
Initial data size	4 Byte
Data for selection of the strain gauge DMS sensor	
Bridge supply voltage EXC	0...12V
Bridge differential voltage SIG	+/-29mV
Rated output	0.5...4mV/V

Order no.	031-1CA20
4 wire connection possible	✓
6 wire connection possible	✓
Possible bridge configuration	symmetric full bridge
Status information, alarms, diagnostics	
Status display	yes
Interrupts	yes, parameterizable
Process alarm	no
Diagnostic interrupt	yes, parameterizable
Diagnostic functions	yes
Diagnostics information read-out	possible
Module state	yes
Module error display	red LED
Channel error display	red LED
Isolation	
Between channels	-
Between channels of groups to	-
Between channels and backplane bus	✓
Between channels and power supply	-
Max. potential difference between circuits	-
Max. potential difference between inputs (Ucm)	-
Max. potential difference between Mana and Mintern (Uiso)	-
Max. potential difference between inputs and Mana (Ucm)	-
Max. potential difference between inputs and Mintern (Uiso)	DC 75 V/ AC 50 V
Max. potential difference between Mintern and outputs	-
Insulation tested with	DC 500 V
Datasizes	
Input bytes	5
Output bytes	1
Parameter bytes	30
Diagnostic bytes	20
Housing	
Material	PC / PPE GF10
Mounting	Profile rail 35 mm
Mechanical data	
Dimensions (WxHxD)	12.9 mm x 109 mm x 76.5 mm

031-1CA20 - AI 1x16(24)Bit Strain gauge (DMS) > Technical data

Order no.	031-1CA20
Net weight	64 g
Weight including accessories	64 g
Gross weight	78 g
Environmental conditions	
Operating temperature	0 °C to 60 °C
Storage temperature	-25 °C to 70 °C
Certifications	
UL certification	yes
KC certification	in preparation

3.16.4 Functionality

3.16.4.1 Basics - Strain gauge DMS

Strain gauge DMS

Strain gauge DMS are fixed directly on a body or part of a sensor and serve for the following possibilities:

- Measurement of strains, compressions or torsions
- Measurement of forces and movements

There are the following strain gauge DMS types:

- electrical strain gauge DMS
 - An *electrical strain gauge DMS* consists of a carrier material (e.g. stretchable plastic film) with applied metal film. From this a grid of electrically conductive resistive material is created. During the measurement the behavior is used, that e.g. at the elongation of a metallic conductor resistance its length increases and its diameter decreases. Here the electrical resistance increases proportionally.
- optical strain gauge DMS
 - An *optical strain gauge DMS* consists of a fibre used as a sensor, with a laser-applied grid in the fibre. During the measurement the behavior is used, that with mechanical load the optical properties of the sensor are changed. Light is passed with a certain wavelength into the sensor. Depending on the deformation of the laser-applied grid of the sensor, a part of the light is reflected and evaluated with a suitable sensor (interrogator).

Characteristics of an strain gauge DMS

- Nominal load
 - Maximum permissible load for normal operation.
 - The *nominal load* is preset unit-free.
- Rated output
 - The rated output is a measure of the sensitivity of the resistance bridge in dependence of the used excitation voltage.
 - A typical value for a full bridge is 2mV/V, this means at nominal load with an excitation voltage of 12V the bridge differential voltage is ±24mV.
 - The common area is 0.5...4mV/V, depending on the bridge and sensor type.

3.16.4.2 Function

Measurement

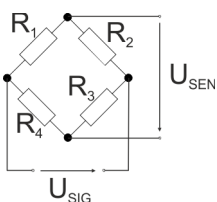

To get a weight value a power supply is applied to the bridge circuit and a differential voltage (U_{SIG}) and excitation voltage (U_{SEN}) are measured. The principle of measurement is based on that the differential voltage U_{SIG} of the bridge changes with a deformation. Thus, a relative weight value is calculated by the difference of the both voltages U_{SIG} and U_{SEN} , which are measured at the same time. The resulting difference is converted to a weight value and stored as process data in the input area.

Weight value determination

With the exception of *differential* and *excitation voltage* the remaining values are to be preset by the parametrization. The resulting weight value Y is determined within the module via the following formulas:

$$Y_R = \frac{U_{SIG}}{U_{SEN}} \cdot RO$$

- Y_R Relative value
- U_{SIG} Measured differential voltage of the measuring bridge
- U_{SEN} Measured excitation voltage
- RO Rated output

031-1CA20 - AI 1x16(24)Bit Strain gauge (DMS) > Parameter data

$$Y_A = Y_R \cdot NL \cdot SF$$

Y_A Absolute value
 Y_R Relative value
 NL Nominal load
 SF Scale factor

$$Y = Y_A \cdot GN + TA$$

Y Resulting weight value
 Y_A Absolute value
 GN Gain
 TA Tara

3.16.5 Parameter data

DS - Record set for access via CPU, PROFIBUS and PROFINET

IX - Index for access via CANopen

SX - Subindex for access via EtherCAT with Index 3100h + EtherCAT-Slot

More can be found in the according manual of your bus coupler.

Parameters

Due to the extensive parameter data you can use up to 8 of these modules with a PROFIBUS slave system.

Name	Bytes	Function	Default	DS	IX	SX
DIAG_EN	1	Diagnostic interrupt *	00h	00h	3100h	01h
UEXC	1	Excitation voltage *	00h	01h	3101h	02h
CAL	2	Calibration interval *	0000	01h	3102h	03h
MEAS	1	Measurement method	23h	80h	3104h	04h
FILT	1	Filter selection	00h	80h	3105h	05h
DFCT	2	Dynamic filter change time	10h	80h	3106h	06h
DFD	2	Dynamic filter delta	20h	80h	3108h	07h
RO	2	Rated output	4E20h	80h	310Ah	08h
ZB	2	Zero balance	0000h	80h	310Ch	09h
GN	2	Gain	1000h	80h	310Eh	0Ah
TA	2	Tara	0000h	80h	3110h	0Bh
NL	2	Nominal load	0002h	80h	3112h	0Ch
SF	2	Scale factor	03E8h	80h	3114h	0Dh
SST	2	Steady state tolerance	0005h	80h	3116h	0Eh
SSW	2	Steady state window	03E8h	80h	3118h	0Fh
RL	4	Reference load	00000100	80h	311Ah	10h

*) This record set may only be transferred at STOP state.

DIAG_EN Diagnostic interrupt

Byte	Bit 7 ... 0
0	<ul style="list-style-type: none"> ■ Diagnostic interrupt <ul style="list-style-type: none"> – 00h: disable – 40h: enable

- Here you activate respectively de-activate the diagnostic function.

UEXC select power supply

Byte	Bit 7 ... 0
0	<ul style="list-style-type: none"> ■ Power supply <ul style="list-style-type: none"> – 00h: 2.5V – 01h: 5V – 02h: 7.5V – 03h: 10V – 04h: 12V

- Here you can specify the power supply for the excitation voltage U_{EXC} , which the module provides via the pins EXC+ und EXC-.



Please always use the excitation voltage U of the module_{EXC}! The connection of strain gauge DMS sensors with external power supply is not possible.

CAL Calibration interval

Byte	Bit 7 ... 0
0...1	<ul style="list-style-type: none"> ■ Interval for the calibration. <ul style="list-style-type: none"> – Calibration interval as 100ms value – 00h: de-activates the calibration

- By setting a calibration interval as 100ms value, the self-calibration is always performed after this time.
- With the self-calibration the internal offset and gain error may be compensated.
- There is always the entire signal path including all passive components checked.
- During self-calibration, the CAL LED is on and the measured value is frozen.
- 00h de-activates the calibration.

MEAS Measurement method

Byte	Bit 7 ... 0
0	<ul style="list-style-type: none"> ■ Measurement method <ul style="list-style-type: none"> – 23h: 6 wire measurement – 25h: 4 wire measurement – FFh: de-activated

- Here you can choose between 4 and 6 wire measurement respectively disable the measurement.

FILT Filter selection

Byte	Bit 7 ... 0
0	<ul style="list-style-type: none"> ■ Filter selection <ul style="list-style-type: none"> – 00h: Filter de-activated – 01h: Activate dynamic IIR filter – 02h: IIR1 – 03h: IIR2 – 04h: IIR3 – 05h: IIR4 – 06h: IIR5 – 07h: IIR6 – 08h: IIR7 – 09h: IIR8 – 0Ah: FIR 50Hz – 0Bh: FIR 60Hz

Filter functions

- FIR 50/60 Hz
 - Suppression of mains frequency interference
- Dynamic IIR filter
 - automatic selection
 - Filter selection dependent on the current weight change
- Static IIR filter
 - De-activation respectively fix setting of a filter level (IIR1...IIR8)

DFCT Dynamic Filter Change Time

Byte	Bit 7 ... 0
0...1	Sampling rate for filter change-over in ms

- Here you can specify the time for re-evaluation for the filter change-over in ms.

Dynamic filter delta

Byte	Bit 7 ... 0
0...1	Limit value for filter change-over

- Here you can specify the limit value for the filter change-over.

RO Rated output

Byte	Bit 7 ... 0
0...1	Rated output in 0.0001mV/V

- Here you can specify the rated output in 0.0001mV/V. Information to the rated output can be found in the data sheet of you force transducer.

ZB Zero balance

Byte	Bit 7 ... 0
0...1	Zero balance in 0.0001mV/V

- Here you can specify the zero balance as 0.0001mV/V value. Information to the zero balance can be found in the data sheet of you force transducer.

GN Gain

Byte	Bit 7 ... 0
0...1	Gain for user scaling of the output value

- Here you can specify a factor as 2^{-12} value. The factor is multiplied with the output value.

TA Tara

Byte	Bit 7 ... 0
0...1	User offset for the output value

- Here you can specify an offset as 2^{-12} value. The offset is added to the determined output value.

NL Nominal load

Byte	Bit 7 ... 0
0...1	Nominal load of the force transducer

- Here you can specify the nominal load of the force transducer unit-free. Information to nominal load can be found in the data sheet of you force transducer.

SF Scale factor

Byte	Bit 7 ... 0
0...1	Scale factor for the nominal load

- Here you can specify the scale factor for the nominal load, such as to convert kg to g.
 - Example: Nominal load in kg and scale factor 1000 (03E8h) results display in g.

SST Steady state tolerance

Byte	Bit 7 ... 0
0...1	Tolerance for <i>Steady State</i>

- Here you can specify a tolerance window for the state *Steady State*. This is specified as a deviation of the scaled nominal load.
 - Example: With a rated load in kg and scaling factor of 1000 (03E8h) you must specify the value 0005h to set a tolerance window of 5g.

SSW Steady state window

Byte	Bit 7 ... 0
0...1	Time interval for <i>Steady State</i> in ms

- Here you can specify a time interval for the setting of the *Steady State* bit (DMS_STAT-Bit 1).
- If the measured value is within the tolerance window SST longer than the time interval SSW, then bit 1 of the status word DMS_STAT is set.

RL Reference load

Byte	Bit 7 ... 0
0...3	Reference load for the calibration

- Here you can specify the reference load for the calibration unit-free. The reference load must be at least 20% of the *Nominal load* NL.

3.16.6 Deployment of the filter functions

Overview

The module has the following filter functions, which can be activated via the parametrization:

- FIR 50/60 Hz
- Dynamic IIR filter
- Static IIR filter

FIR 50/60 Hz

In the parametrization via FILT you can specify the filter *FIR 50 Hz* respectively *FIR 60 Hz*. These filters act as notch filters. Notch filters generate a notch at the configured frequency and the multiples thereof (zeros/notches) in the frequency response. They attenuate these frequencies in the amplitude. When filters are used, they influence the conversion time of your module. The higher the filter frequency, the faster the conversion time. This can be used for the suppression of mains frequency interferences.

Dynamic IIR filter

- By activation of the dynamic IIR filter in the FILT parameter, dependent on the current weight change, it is automatically switched between 8 different filters. The aim here is to obtain a filter with the best possible damping, which must lead to stable measuring values. The *Dynamic IIR filter* acts as 1. order low-pass filter and has the following properties:
 - If there is a rapid change of the input value, it is switched-over to the next lower filter (e.g. IIR1→IIR2). In this way the load changes are less precise, but it is faster recognized.
 - If there is a small change in the measured value, it is switched-over to the next higher filter (e.g. IIR2→IIR1), so you will get a higher precision.
 - With the IIR1 filter you get the lowest noise suppression and the most unstable measured value.
 - With the IIR8 filter you get the highest noise suppression and the most stable measured value.
 - The reevaluation, which can lead to a modification of the filter levels, takes place in a fixed interval, which can be specified via parameter *DFCT* in ms.

Filter level	Limit frequency	Filter constant	Rise time 10-90% [s] (typ.)
02h: IIR1	1000	$a_0 = 0.5$	0.0003
03h: IIR2	500Hz	$a_0 = 0.25$	0.0008
04h: IIR3	125Hz	$a_0 = 62.5 \times 10^{-3}$	0.0035
05h: IIR4	30Hz	$a_0 = 15.6 \times 10^{-3}$	0.014
06h: IIR5	8Hz	$a_0 = 3.91 \times 10^{-3}$	0.056
07h: IIR6	2Hz	$a_0 = 977 \times 10^{-6}$	0.225
08h: IIR7	0.5Hz	$a_0 = 244 \times 10^{-6}$	0.9
09h: IIR8	0.1Hz	$a_0 = 61.0 \times 10^{-6}$	3.6



Prevent overriding the filter

By a brief activation of Input Freeze in the command byte *DMS_CMD* pulses, e.g. caused by a filling procedure can be prevented, which would override the filter unnecessarily. As soon as Input Freeze is activated, no measurement values are passed to the digital filter.

Static IIR filter

Via the FILT parameter you can de-activate the filter function or you can specify a fix filter level (IIR1...IIR8).

3.16.7 Calibration**Proceeding**

Please use for the calibration the software filter IR8 (slow). The following steps are necessary for the calibration:

1. ➤ Specify in the parametrization the *Reference load* RL. The *Reference load* must be at least 20% of the *Nominal load*.
2. ➤ Operate the balance without load.
3. ➤ As soon as a stable value is shown, bit 6 (set zero point) in the command byte *DMS_CMD* is to set.
4. ➤ Apply the balance with the reference load. As soon as a stable value is shown, bit 7 (set reference point) in the command byte *DMS_CMD* is to set.
5. ➤ Set bit 1 (store adjustment) in the command byte *DMS_CMD*.
 - ⇒ As soon as the adjustment data were stored successfully, the module measures with these parameters. The adjustment data remain even after a power loss condition and can be deleted (delete adjustment) via bit 2. The adjustment data can be rewritten only every 120 seconds.

3.16.8 Steady state detection**Functionality**

- If the measured value is within the range of values *SST* longer than the the time interval *SSW*, then bit 1 (steady state active) of the status word *DMS_STAT* is set. The current measured value is used as the starting point for the range of values and the steady state timer is started. ↪ *'DMS_STAT Status' page 180*
- If the measured value remains within *SST* over the period *SSW*, the steady-state bit is set.
- If the tolerance range *SST* is exceeded, the last measured value is used as starting point and the time is newly started.
- The values *SSW* and *SST* can be specified by the parametrization. ↪ *Chap. 3.16.5 'Parameter data' page 186*

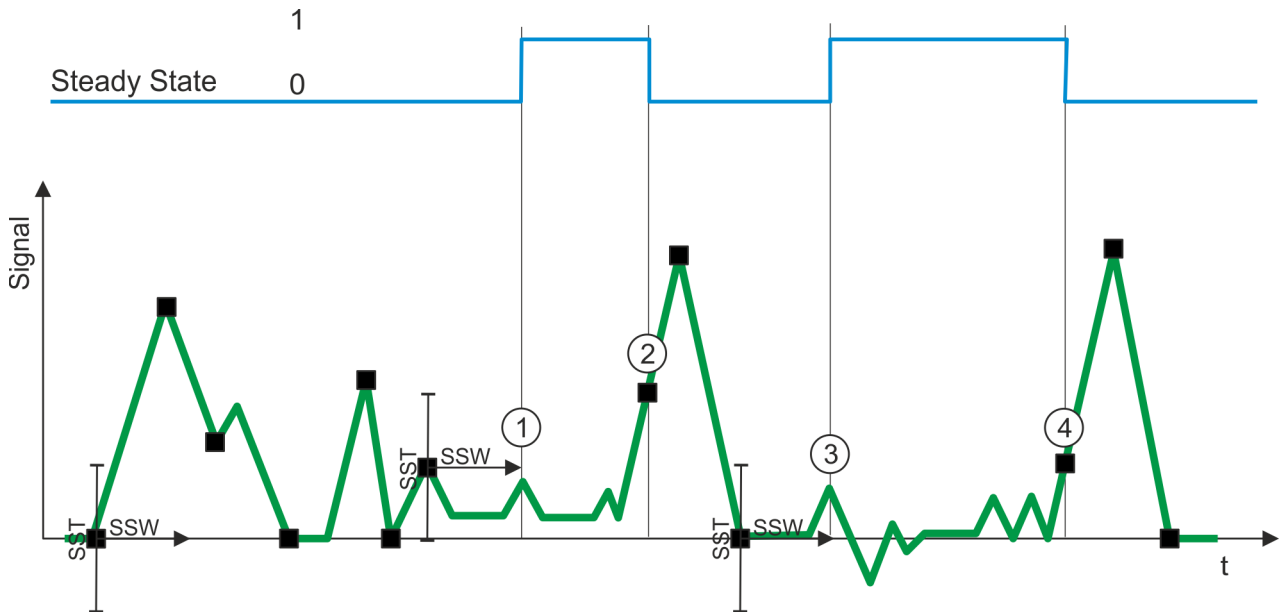

- Starting point of the SSW timer is newly started. Only when the measured signal is longer than the time SSW within the range of values SST, steady state is set.
- [1] SSW timer has expired and the measured signal is within the range of values → Steady state bit is set.
- [2] Measured signal exceeds the range of values → Steady state bit is reset.
- [3] SSW timer has expired and the measured signal is within the range of values → Steady state bit is set.
- [4] Measured signal exceeds the range of values → Steady state bit is reset.

3.16.9 Diagnostics

Diagnostic data

Via the parameterization you may activate a diagnostic interrupt for the module. With a diagnostics interrupt the module serves for diagnostics data for diagnostic interrupt_{incoming}. As soon as the reason for releasing a diagnostic interrupt is no longer present, the diagnostic interrupt_{going} automatically takes place. All events of a channel between diagnostic interrupt_{incoming} and diagnostic interrupt_{going} are not stored and get lost. Within this time window (1. diagnostic interrupt_{incoming} until last diagnostic interrupt_{going}) the MF-LED of the module is on.

The following events can cause a diagnostic interrupt:

- External auxiliary supply is missing
- Internal diagnostic puffer overflow
- Internal communication error
- Project engineering/parametrization error
- Measuring range underflow
- Measuring range overerflow

DS - Record set for access via CPU, PROFIBUS and PROFINET. The access happens by DS 01h. Additionally the first 4 bytes may be accessed by DS 00h.

IX - Index for access via CANopen. The access happens by IX 2F01h. Additionally the first 4 bytes may be accessed by IX 2F00h.

SX - Subindex for access via EtherCAT with Index 5005h.

More can be found in the according manual of your bus coupler.

Name	Bytes	Function	Default	DS	IX	SX
ERR_A	1	Diagnostic	00h	01h	2F01h	02h
MODTYP	1	Module information	15h			03h
ERR_C	1	reserved	00h			04h
ERR_D	1	Diagnostic	00h			05h
CHTYP	1	Channel type	71h			06h
NUMBIT	1	Number diagnostic bits per channel	08h			07h
NUMCH	1	Number of channels of a module	01h			08h
CHERR	1	Channel error	00h			09h
CHxERR	8	Channel-specific error channel x	00h			0Ah...11h
DIAG_US	4	µs ticker	00h			13h

ERR_A Diagnostic

Byte	Bit 7 ... 0
0	<ul style="list-style-type: none"> ■ Bit 0: set at module failure ■ Bit 1: reserved ■ Bit 2: set at external error ■ Bit 3: set at channel error ■ Bit 4: set at external auxiliary supply missing ■ Bit 6 ... 5: reserved ■ Bit 7: set at error in parameterization

MODTYP Module information

Byte	Bit 7 ... 0
0	<ul style="list-style-type: none"> ■ Bit 3 ... 0: module class <ul style="list-style-type: none"> – 0101b analog module ■ Bit 4: set at channel information present ■ Bit 7 ... 5: reserved

ERR_C reserved

Byte	Bit 7 ... 0
0	reserved

ERR_D Diagnostic

Byte	Bit 7 ... 0
0	<ul style="list-style-type: none"> ■ Bit 2 ... 0: reserved ■ Bit 3: set at internal diagnostics buffer overflow ■ Bit 4: set at internal communication error ■ Bit 7 ... 5: reserved

CHTYP Channel type

Byte	Bit 7 ... 0
0	<ul style="list-style-type: none"> ■ Bit 6 ... 0: Channel type <ul style="list-style-type: none"> – 70h: Digital input – 71h: Analog input – 72h: Digital output – 73h: Analog output – 74h: Analog input/-output – 76h: Counter ■ Bit 7: reserved

NUMBIT Diagnostic bits

Byte	Bit 7 ... 0
0	Number of diagnostic bits per channel (here 08h)

NUMCH Channels

Byte	Bit 7 ... 0
0	Number of channels of the module (here 01h)

CHERR Channel error

Byte	Bit 7 ... 0
0	<ul style="list-style-type: none"> ■ Bit 0: set at error in channel 0

CHxERR Channel-specific

Byte	Bit 7 ... 0
0	Channel-specific error channel 0 <ul style="list-style-type: none"> ■ Bit 0: set at project engineering respectively parametrization error ■ Bit 2...1: reserved ■ Bit 3: set at short circuit of excitation voltage U_{EXC} ■ Bit 5...4: reserved ■ Bit 6: set at measuring range underflow ■ Bit 7: set at measuring range overflow
1...7	reserved

DIAG_US μ s ticker

Byte	Bit 7 ... 0
0...3	Value of the μ s ticker at the moment of the diagnostic

 μ s ticker

In the System SLIO module there is a timer (μ s ticker). With PowerON the timer starts counting with 0. After $2^{32}-1\mu$ s the timer starts with 0 again.

3.17 031-1CB30 - AI 2x16Bit 0...10V

Properties

The electronic module has 2 inputs with parameterizable functions. The channels of the module are electrically isolated from the backplane bus. In addition, the channels are isolated to the DC 24V power supply by means of DC/DC converter.

- 2 analog inputs
- Suited for sensors with 0 ... 10V
- Interrupt and diagnostics function
- Interference frequency suppression parameterizable (50/60Hz)
- 16bit resolution

Structure

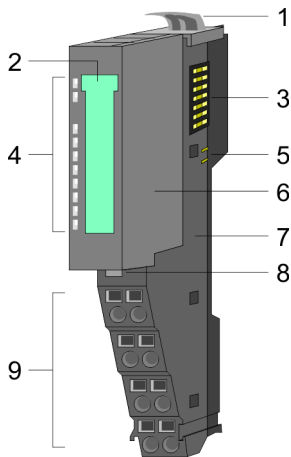

- 1 Locking lever terminal module
- 2 Labeling strip
- 3 Backplane bus
- 4 LED status indication
- 5 DC 24V power section supply
- 6 Electronic module
- 7 Terminal module
- 8 Locking lever electronic module
- 9 Terminal

Status indication

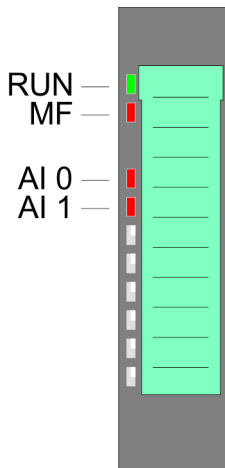

RUN ■ green	MF ■ red	AI x ■ red	Description
■	□	X	Bus communication is OK Module status is OK
■	■	X	Bus communication is OK Module status reports an error
□	■	X	Bus communication is not possible Module status reports an error
□	□	X	Error at bus power supply
X	▣ 2Hz	X	Error in configuration ↗ <i>Chap. 2.8 'Trouble shooting - LEDs' page 30</i>
■	□	■	Error channel x <ul style="list-style-type: none"> ■ Signal leaves measuring range ■ Error in parameterization
not relevant: X			

Pin assignment

For wires with a cross section of 0.08mm² up to 1.5mm².

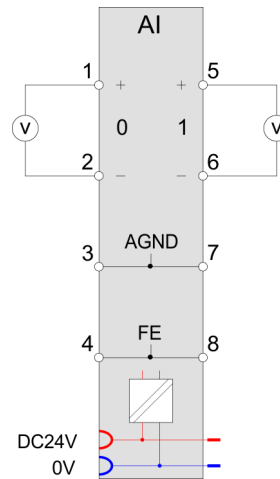
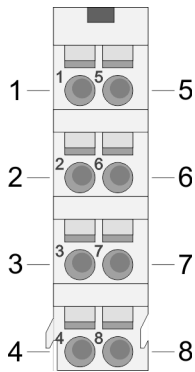

Pos.	Function	Type	Description
1	+AI 0	I	+ Channel 0
2	-AI 0	I	Ground Channel 0
3	AGND	I	Reference potential for differential-mode input
4	FE	I	Functional ground for cable shield (an additional shield bus carrier is not necessary)
5	+AI 1	I	+ Channel 1
6	-AI 1	I	Ground Channel 1
7	AGND	I	Reference potential for differential-mode input
8	FE	I	Functional ground for cable shield (an additional shield bus carrier is not necessary)

I: Input

In-/Output area

At CPU, PROFIBUS and PROFINET the input respectively output area is embedded to the corresponding address area.

IX - Index for access via CANopen with s = Subindex, depends on number and type of analog modules

SX - Subindex for access via EtherCAT with Index 6000h + EtherCAT-Slot

More can be found in the according manual of your bus coupler.

Input area

Addr.	Name	Bytes	Function	IX	SX
+0	AI 0	2	Analog value channel 0	6401h/s	01h
+2	AI 1	2	Analog value channel 1	6401h/s+1	02h

Output area No byte of the output area is used by the module.

3.17.1 Technical data

Order no.	031-1CB30
Type	SM 031
Module ID	040A 1543
Current consumption/power loss	
Current consumption from backplane bus	60 mA
Power loss	0.8 W
Technical data analog inputs	
Number of inputs	2
Cable length, shielded	200 m
Rated load voltage	DC 24 V
Current consumption from load voltage L+ (without load)	20 mA
Voltage inputs	✓
Min. input resistance (voltage range)	200 kΩ
Input voltage ranges	0 V ... +10 V
Operational limit of voltage ranges	+/-0.2%
Operational limit of voltage ranges with SFU	-
Basic error limit voltage ranges	+/-0.1%
Basic error limit voltage ranges with SFU	-
Destruction limit voltage	max. 30V
Current inputs	-
Max. input resistance (current range)	-
Input current ranges	-
Operational limit of current ranges	-
Operational limit of current ranges with SFU	-
Basic error limit current ranges	-
Radical error limit current ranges with SFU	-
Destruction limit current inputs (voltage)	-
Destruction limit current inputs (electrical current)	-
Resistance inputs	-
Resistance ranges	-
Operational limit of resistor ranges	-
Operational limit of resistor ranges with SFU	-
Basic error limit	-
Basic error limit with SFU	-

Order no.	031-1CB30
Destruction limit resistance inputs	-
Resistance thermometer inputs	-
Resistance thermometer ranges	-
Operational limit of resistance thermometer ranges	-
Operational limit of resistance thermometer ranges with SFU	-
Basic error limit thermoresistor ranges	-
Basic error limit thermoresistor ranges with SFU	-
Destruction limit resistance thermometer inputs	-
Thermocouple inputs	-
Thermocouple ranges	-
Operational limit of thermocouple ranges	-
Operational limit of thermocouple ranges with SFU	-
Basic error limit thermoelement ranges	-
Basic error limit thermoelement ranges with SFU	-
Destruction limit thermocouple inputs	-
Programmable temperature compensation	-
External temperature compensation	-
Internal temperature compensation	-
Temperature error internal compensation	-
Technical unit of temperature measurement	-
Resolution in bit	16
Measurement principle	successive approximation
Basic conversion time	240 µs all channels
Noise suppression for frequency	>80dB at 50Hz (UCM<9V)
Status information, alarms, diagnostics	
Status display	yes
Interrupts	yes, parameterizable
Process alarm	yes, parameterizable
Diagnostic interrupt	yes, parameterizable
Diagnostic functions	yes
Diagnostics information read-out	possible
Module state	green LED
Module error display	red LED
Channel error display	red LED per channel
Isolation	

Order no.	031-1CB30
Between channels	-
Between channels of groups to	-
Between channels and backplane bus	✓
Between channels and power supply	✓
Max. potential difference between circuits	-
Max. potential difference between inputs (Ucm)	DC 9 V
Max. potential difference between Mana and Mintern (Uiso)	-
Max. potential difference between inputs and Mana (Ucm)	DC 1 V
Max. potential difference between inputs and Mintern (Uiso)	DC 75 V/ AC 50 V
Max. potential difference between Mintern and outputs	-
Insulation tested with	DC 500 V
Datasizes	
Input bytes	4
Output bytes	0
Parameter bytes	20
Diagnostic bytes	20
Housing	
Material	PPE / PPE GF10
Mounting	Profile rail 35 mm
Mechanical data	
Dimensions (WxHxD)	12.9 mm x 109 mm x 76.5 mm
Net weight	60 g
Weight including accessories	60 g
Gross weight	75 g
Environmental conditions	
Operating temperature	0 °C to 60 °C
Storage temperature	-25 °C to 70 °C
Certifications	
UL certification	yes
KC certification	yes

SFU - Interference frequency suppression

3.17.2 Parameter data

DS - Record set for access via CPU, PROFIBUS and PROFINET

IX - Index for access via CANopen

SX - Subindex for access via EtherCAT with Index 3100h + EtherCAT-Slot

More can be found in the according manual of your bus coupler.

Name	Bytes	Function	Default	DS	IX	SX
DIAG	1	Diagnostics*	00h	00h	3100h	01h
RES1	1	reserved*	00h	00h	3101h	02h
LIMIT_EN	1	Limit value monitoring*	00h	00h	3102h	03h
SUPR	1	Interference frequency suppression (SFU)	00h	01h	3103h	04h
CH0FN	1	Function number channel 0	10h	80h	3104h	05h
RES7	1	reserved	00h	80h	3105h	06h
CH0UL	2	Upper limit value channel 0	7FFFh	80h	3106h...3107h	07h
CH0LL	2	Lower limit value channel 0	8000h	80h	3108h...3109h	08h
CH1FN	1	Function number channel 1	10h	81h	310Ah	09h
RES13	1	reserved	00h	81h	310Bh	0Ah
CH1UL	2	Upper limit value channel 1	7FFFh	81h	310Ch...310Dh	0Bh
CH1LL	2	Lower limit value channel 1	8000h	81h	310Eh...310Fh	0Ch

* This record set may only be transferred at STOP state.

DIAG_EN Diagnostic interrupt

Byte	Bit 7 ... 0
0	<ul style="list-style-type: none"> ■ Diagnostic interrupt <ul style="list-style-type: none"> – 00h: disabled – 40h: enabled

■ Here you can enable respectively disable the diagnostic interrupt.

LIMIT_EN Limit value monitoring

Byte	Bit 7 ... 0
0	<ul style="list-style-type: none"> ■ Bit 0: Limit value monitoring channel 0 (1: on) ■ Bit 1: Limit value monitoring channel 1 (1: on) ■ Bit 7 ... 2: reserved

SUPR Interference frequency suppression (SFU)

Byte	Bit 7 ... 0
0	<ul style="list-style-type: none"> ■ Bit 1, 0: Interference frequency suppression channel 0 <ul style="list-style-type: none"> – 00: deaktiviert – 01: 60Hz – 10: 50Hz ■ Bit 3, 2: Interference frequency suppression channel 1 <ul style="list-style-type: none"> – 00: deaktiviert – 01: 60Hz – 10: 50Hz ■ Bit 7 ... 4: reserved

CHxFN Function number channel x

In the following there are the measuring ranges with function number listed, which were supported by the analog module. With FFh the corresponding channel is deactivated. The formulas listed here allow you to transform an evaluated measuring value (digital value) to a value assigned to the measuring range (analog value) and vice versa.

0 ... 10V

Meas. range (funct. no.)	Voltage (U)	Decimal (D)	Hex	Range	Formulas
0 ... 10V Siemens S7 format (10h)	11.76V	32511	7EFFh	overrange	$D = 27648 \cdot \frac{U}{10}$ $U = D \cdot \frac{10}{27648}$
	10V	27648	6C00h	nominal range	
	5V	13824	3600h		
	0V	0	0000h		
	-1.76V	-4864	ED00h	underrange	
0 ... 10V Siemens S5 format (20h)	12.5V	20480	5000h	overrange	$D = 16384 \cdot \frac{U}{10}$ $U = D \cdot \frac{10}{16384}$
	10V	16384	4000h	nominal range	
	5V	8192	2000h		
	0V	0	0000h		
	-2V	-3277	F333h	underrange	

CHxUL CHxLL Upper limit value Lower limit value channel x

For each channel an *upper* and a *lower limit* may be defined. Here only values of the nominal range may be preset, otherwise you receive a parameterization error. By presetting 7FFFh for the upper respectively 8000h for the lower limit value the corresponding limit is deactivated. As soon as the measuring value is beyond the limits and the limit value monitoring is activated, a process interrupt is initialized.

3.17.3 Diagnostics and interrupt

Event	Process interrupt	Diagnostics interrupt	parameterizable
Error in project engineering/ parameterization	-	X	-
Measuring range overflow	-	X	-
Measuring range underflow	-	X	-
Limit overflow	X	-	X
Limit underflow	X	-	X
Diagnostic buffer overflow	-	X	-
Communication error	-	X	-
Process interrupt lost	-	X	-

Process interrupt

So you may react to asynchronous events, there is the possibility to activate a process interrupt. A process interrupt interrupts the linear program sequence and jumps depending on the master system to a corresponding Interrupt routine. Here you can react to the process interrupt accordingly.

With CANopen the process interrupt data is transferred via an emergency telegram.

Operating with CPU, PROFIBUS and PROFINET the process interrupt data were transferred via diagnostics telegram.

SX - Subindex for access via EtherCAT with Index 5000h

More can be found in the according manual of your bus coupler.

Name	Bytes	Function	Default	SX
PRIT_OL	1	Upper limit overflow channel x	00h	02h
PRIT_UL	1	Lower limit underflow channel x	00h	03h
PRIT_US	2	µs-Ticker	00h	04h (high byte) 05h (low byte)

PRIT_OL Limit overflow

Byte	Bit 7 ... 0
0	<ul style="list-style-type: none"> ■ Bit 0: Limit overflow channel 0 ■ Bit 1: Limit overflow channel 1 ■ Bit 7 ... 2: reserved

PRIT_UL Limit underflow

Byte	Bit 7 ... 0
0	<ul style="list-style-type: none"> ■ Bit 0: Limit underflow channel 0 ■ Bit 1: Limit underflow channel 1 ■ Bit 7 ... 2: reserved

PRIT_US μ s ticker

Byte	Bit 7 ... 0
0 ... 1	Value of the μ s ticker at the moment of the diagnostic.

 μ s ticker

In the SLIO module there is a 32 bit timer (μ s ticker). With PowerON the timer starts counting with 0. After $2^{32}-1\mu$ s the timer starts with 0 again. PRIT_US represents the lower 2 byte of the μ s ticker value (0 ... $2^{16}-1$).

Diagnostic data

Via the parameterization you may activate a diagnostic interrupt for the module. With a diagnostics interrupt the module serves for diagnostics data for diagnostic interrupt_{incoming}. As soon as the reason for releasing a diagnostic interrupt is no longer present, the diagnostic interrupt_{going} automatically takes place. All events of a channel between diagnostic interrupt_{incoming} and diagnostic interrupt_{going} are not stored and get lost. Within this time window (1. diagnostic interrupt_{incoming} until last diagnostic interrupt_{going}) the MF-LED of the module is on.

The following errors are listed in the diagnostics data:

- Error in project engineering / parameterization
- Measuring range overflow
- Measuring range underflow
- Process interrupt lost
- Power supply failed

DS - Record set for access via CPU, PROFIBUS and PROFINET. The access happens by DS 01h. Additionally the first 4 bytes may be accessed by DS 00h.

IX - Index for access via CANopen. The access happens by IX 2F01h. Additionally the first 4 bytes may be accessed by IX 2F00h.

SX - Subindex for access via EtherCAT with Index 5005h.

More can be found in the according manual of your bus coupler.

Name	Bytes	Function	Default	DS	IX	SX
ERR_A	1	Diagnostic	00h	01h	2F01h	02h
MODTYP	1	Module information	15h			03h
ERR_C	1	reserved	00h			04h
ERR_D	1	Diagnostic	00h			05h
CHTYP	1	Channel type	71h			06h
NUMBIT	1	Number diagnostic bits per channel	08h			07h
NUMCH	1	Number of channels of a module	02h			08h
CHERR	1	Channel error	00h			09h
CH0ERR	1	Channel-specific error channel 0	00h			0Ah
CH1ERR	1	Channel-specific error channel 1	00h			0Bh
CH2ERR... CH7ERR	6	reserved	00h			0Ch ... 11h
DIAG_US	4	μ s ticker	00h			13h

ERR_A Diagnostic

Byte	Bit 7 ... 0
0	<ul style="list-style-type: none"> ■ Bit 0: set at module failure ■ Bit 1: set at internal error ■ Bit 2: set at external error ■ Bit 3: set at channel error ■ Bit 4: set at external auxiliary supply missing ■ Bit 6 ... 5: reserved ■ Bit 7: set at error in parameterization

MODTYP Module information

Byte	Bit 7 ... 0
0	<ul style="list-style-type: none"> ■ Bit 3 ... 0: module class <ul style="list-style-type: none"> – 0101b analog module ■ Bit 4: set at channel information present ■ Bit 7 ... 5: reserved

ERR_D Diagnostic

Byte	Bit 7 ... 0
0	<ul style="list-style-type: none"> ■ Bit 2 ... 0: reserved ■ Bit 3: set at internal diagnostics buffer overflow ■ Bit 4: set at internal communication error ■ Bit 5: reserved ■ Bit 6: set at process interrupt lost ■ Bit 7: reserved

CHTYP Channel type

Byte	Bit 7 ... 0
0	<ul style="list-style-type: none"> ■ Bit 6 ... 0: Channel type <ul style="list-style-type: none"> – 70h: Digital input – 71h: Analog input – 72h: Digital output – 73h: Analog output – 74h: Analog input/-output – 76h: Counter ■ Bit 7: reserved

NUMBIT Diagnostic bits

Byte	Bit 7 ... 0
0	Number of diagnostic bits per channel (here 08h)

NUMCH Channels

Byte	Bit 7 ... 0
0	Number of channels of a module (here 02h)

CHERR Channel error

Byte	Bit 7 ... 0
0	<ul style="list-style-type: none"> ■ Bit 0: set at error in channel group 0 ■ Bit 1: set at error in channel group 1 ■ Bit 7 ... 2: reserved

**CH0ERR CH1ERR
Channel-specific**

Byte	Bit 7 ... 0
0	Channel-specific error channel x: <ul style="list-style-type: none"> ■ Bit 0: set at configuring/parameter assignment error ■ Bit 4 ... 1: reserved ■ Bit 5: set at process interrupt lost ■ Bit 6: set at measuring range underflow ■ Bit 7: set at measuring range overflow

DIAG_US μ s ticker

Byte	Bit 7 ... 0
0...3	Value of the μ s ticker at the moment of the diagnostic

 μ s ticker

In the System SLIO module there is a timer (μ s ticker). With PowerON the timer starts counting with 0. After $2^{32}-1\mu$ s the timer starts with 0 again.

3.18 031-1CB40 - AI 2x16Bit 0(4)...20mA

Properties

The electronic module has 2 inputs with parameterizable functions. The channels of the module are electrically isolated from the backplane bus. In addition, the channels are isolated to the DC 24V power supply by means of DC/DC converter.

- 2 analog inputs
- Suited for sensors with 0 ... 20mA;
4 ... 20mA with external supply
- Interrupt and diagnostics function
- Interference frequency suppression parameterizable (50/60Hz)
- 16bit resolution

Structure

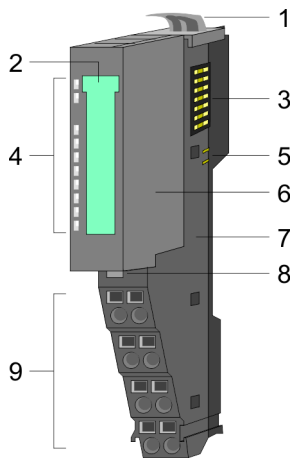

- 1 Locking lever terminal module
- 2 Labeling strip
- 3 Backplane bus
- 4 LED status indication
- 5 DC 24V power section supply
- 6 Electronic module
- 7 Terminal module
- 8 Locking lever electronic module
- 9 Terminal

Status indication

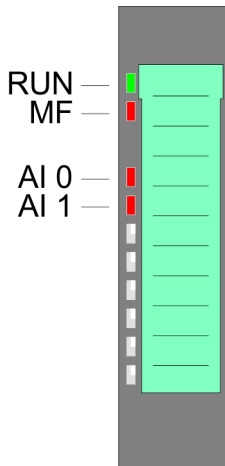

RUN	MF	AI x	Description
■ green	■ red	■ red	
■	<input type="checkbox"/>	X	Bus communication is OK Module status is OK
■	■	X	Bus communication is OK Module status reports an error
<input type="checkbox"/>	■	X	Bus communication is not possible Module status reports an error
<input type="checkbox"/>	<input type="checkbox"/>	X	Error at bus power supply
X	▣ 2Hz	X	Error in configuration Chap. 2.8 'Trouble shooting - LEDs' page 30
■	<input type="checkbox"/>	■	Error channel x <ul style="list-style-type: none"> ■ Signal leaves measuring range ■ Error in parameterization
not relevant: X			

Pin assignment

For wires with a cross section of 0.08mm² up to 1.5mm².

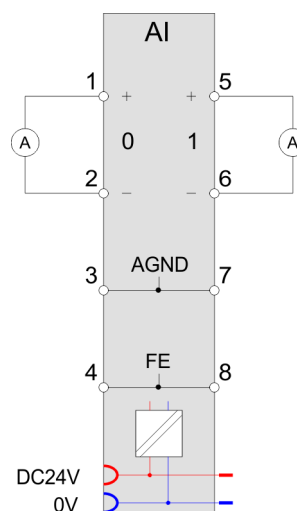
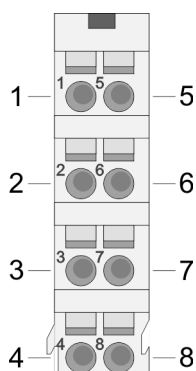

Pos.	Function	Type	Description
1	+AI 0	I	+ Channel 0
2	-AI 0	I	Ground Channel 0
3	AGND	I	Reference potential for differential-mode input
4	FE	I	Functional ground for cable shield (an additional shield bus carrier is not necessary)
5	+AI 1	I	+ Channel 1
6	-AI 1	I	Ground Channel 1
7	AGND	I	Reference potential for differential-mode input
8	FE	I	Functional ground for cable shield (an additional shield bus carrier is not necessary)

I: Input



If a 2wire measuring transducer is used, you have to connect in line an external power supply.

In-/Output area

At CPU, PROFIBUS and PROFINET the input respectively output area is embedded to the corresponding address area.

IX - Index for access via CANopen with s = Subindex, depends on number and type of analog modules

SX - Subindex for access via EtherCAT with Index 6000h + EtherCAT-Slot

More can be found in the according manual of your bus coupler.

Input area

Addr.	Name	Bytes	Function	IX	SX
+0	AI 0	2	Analog value channel 0	6401h/s	01h
+2	AI 1	2	Analog value channel 1	6401h/s+1	02h

Output area

No byte of the output area is used by the module.

3.18.1 Technical data

Order no.	031-1CB40
Type	SM 031
Module ID	040B 1543
Current consumption/power loss	
Current consumption from backplane bus	60 mA
Power loss	0.7 W
Technical data analog inputs	
Number of inputs	2
Cable length, shielded	200 m
Rated load voltage	DC 24 V
Current consumption from load voltage L+ (without load)	15 mA
Voltage inputs	-
Min. input resistance (voltage range)	-
Input voltage ranges	-
Operational limit of voltage ranges	-
Operational limit of voltage ranges with SFU	-
Basic error limit voltage ranges	-
Basic error limit voltage ranges with SFU	-
Destruction limit voltage	-
Current inputs	✓
Max. input resistance (current range)	60 Ω
Input current ranges	0 mA ... +20 mA +4 mA ... +20 mA
Operational limit of current ranges	+/-0.2%
Operational limit of current ranges with SFU	-
Basic error limit current ranges	+/-0.1%
Radical error limit current ranges with SFU	-
Destruction limit current inputs (voltage)	max. 24V
Destruction limit current inputs (electrical current)	max. 40mA

Order no.	031-1CB40
Resistance inputs	-
Resistance ranges	-
Operational limit of resistor ranges	-
Operational limit of resistor ranges with SFU	-
Basic error limit	-
Basic error limit with SFU	-
Destruction limit resistance inputs	-
Resistance thermometer inputs	-
Resistance thermometer ranges	-
Operational limit of resistance thermometer ranges	-
Operational limit of resistance thermometer ranges with SFU	-
Basic error limit thermoresistor ranges	-
Basic error limit thermoresistor ranges with SFU	-
Destruction limit resistance thermometer inputs	-
Thermocouple inputs	-
Thermocouple ranges	-
Operational limit of thermocouple ranges	-
Operational limit of thermocouple ranges with SFU	-
Basic error limit thermoelement ranges	-
Basic error limit thermoelement ranges with SFU	-
Destruction limit thermocouple inputs	-
Programmable temperature compensation	-
External temperature compensation	-
Internal temperature compensation	-
Temperature error internal compensation	-
Technical unit of temperature measurement	-
Resolution in bit	16
Measurement principle	successive approximation
Basic conversion time	240 µs all channels
Noise suppression for frequency	>80dB (UCM<4V)
Status information, alarms, diagnostics	
Status display	yes
Interrupts	yes, parameterizable
Process alarm	yes, parameterizable
Diagnostic interrupt	yes, parameterizable

031-1CB40 - AI 2x16Bit 0(4)...20mA > Technical data

Order no.	031-1CB40
Diagnostic functions	yes
Diagnostics information read-out	possible
Module state	green LED
Module error display	red LED
Channel error display	red LED per channel
Isolation	
Between channels	-
Between channels of groups to	-
Between channels and backplane bus	✓
Between channels and power supply	✓
Max. potential difference between circuits	-
Max. potential difference between inputs (Ucm)	DC 4 V
Max. potential difference between Mana and Mintern (Uiso)	-
Max. potential difference between inputs and Mana (Ucm)	DC 3 V
Max. potential difference between inputs and Mintern (Uiso)	DC 75 V/ AC 50 V
Max. potential difference between Mintern and outputs	-
Insulation tested with	DC 500 V
Datasizes	
Input bytes	4
Output bytes	0
Parameter bytes	20
Diagnostic bytes	20
Housing	
Material	PPE / PPE GF10
Mounting	Profile rail 35 mm
Mechanical data	
Dimensions (WxHxD)	12.9 mm x 109 mm x 76.5 mm
Net weight	60 g
Weight including accessories	60 g
Gross weight	74 g
Environmental conditions	
Operating temperature	0 °C to 60 °C
Storage temperature	-25 °C to 70 °C
Certifications	

Order no.	031-1CB40
UL certification	yes
KC certification	yes

SFU - Interference frequency suppression

3.18.2 Parameter data

DS - Record set for access via CPU, PROFIBUS and PROFINET

IX - Index for access via CANopen

SX - Subindex for access via EtherCAT with Index 3100h + EtherCAT-Slot

More can be found in the according manual of your bus coupler.

Name	Bytes	Function	Default	DS	IX	SX
DIAG_EN	1	Diagnostics*	00h	00h	3100h	01h
RES1	1	reserved*	00h	00h	3101h	02h
LIMIT_EN	1	Limit value monitoring*	00h	00h	3102h	03h
SUPR	1	Interference frequency suppression (SFU)	00h	01h	3103h	04h
CH0FN	1	Function number channel 0	31h	80h	3104h	05h
RES7	1	reserved	00h	80h	3105h	06h
CH0UL	2	Upper limit value channel 0	7FFFh	80h	3106h...3107h	07h
CH0LL	2	Lower limit value channel 0	8000h	80h	3108h...3109h	08h
CH1FN	1	Function number channel 1	31h	81h	310Ah	09h
RES13	1	reserved	00h	81h	310Bh	0Ah
CH1UL	2	Upper limit value channel 1	7FFFh	81h	310Ch...310Dh	0Bh
CH1LL	2	Lower limit value channel 1	8000h	81h	310Eh...310Fh	0Ch

* This record set may only be transferred at STOP state.

DIAG_EN Diagnostic interrupt

Byte	Bit 7 ... 0
0	<ul style="list-style-type: none"> ■ Diagnostic interrupt <ul style="list-style-type: none"> – 00h: disabled – 40h: enabled

■ Here you can enable respectively disable the diagnostic interrupt.

LIMIT_EN Limit value monitoring

Byte	Bit 7 ... 0
0	<ul style="list-style-type: none"> ■ Bit 0: Limit value monitoring channel 0 (1: on) ■ Bit 1: Limit value monitoring channel 1 (1: on) ■ Bit 7 ... 2: reserved

SUPR Interference frequency suppression (SFU)

Byte	Bit 7 ... 0
0	<ul style="list-style-type: none"> ■ Bit 1, 0: Interference frequency suppression channel 0 <ul style="list-style-type: none"> – 00: deaktiviert – 01: 60Hz – 10: 50Hz ■ Bit 3, 2: Interference frequency suppression channel 1 <ul style="list-style-type: none"> – 00: deaktiviert – 01: 60Hz – 10: 50Hz ■ Bit 7 ... 4: reserved

CHxFN Function number channel x

In the following there are the measuring ranges with corresponding function number listed, which were supported by the analog module. With FFh the corresponding channel is deactivated. The formulas listed here allow you to transform an evaluated measuring value (digital value) to a value assigned to the measuring range (analog value) and vice versa.

0(4) ... 20mA

Meas. range (funct. no.)	Current (I)	Decimal (D)	Hex	Range	Formulas
0 ... 20mA Siemens S7 format (31h)	23.52mA	32511	7EFFh	overrange	$D = 27648 \cdot \frac{I}{20}$ $I = D \cdot \frac{20}{27648}$
	20mA	27648	6C00h	nominal range	
	10mA	13824	3600h		
	0mA	0	0000h		
	-3.52mA	-4864	ED00h	underrange	
0 ... 20mA Siemens S5 format (41h)	25.00mA	20480	5000h	overrange	$D = 16384 \cdot \frac{I}{20}$ $I = D \cdot \frac{20}{16384}$
	20mA	16384	4000h	nominal range	
	10mA	8192	2000h		
	0mA	0	0000h		
	-4,00mA	-3277	F333h	underrange	
4 ... 20mA Siemens S7 format (30h)	22.81mA	32511	7EFFh	overrange	$D = 27648 \cdot \frac{I-4}{16}$ $I = D \cdot \frac{16}{27648} + 4$
	20mA	27648	6C00h	nominal range	
	12mA	13824	3600h		
	4mA	0	0000h		
	1.19mA	-4864	ED00h	underrange	
4 ... 20mA Siemens S5 format (40h)	24.00mA	20480	5000h	overrange	$D = 16384 \cdot \frac{I-4}{16}$ $I = D \cdot \frac{16}{16384} + 4$
	20mA	16384	4000h	nominal range	
	12mA	8192	2000h		
	4mA	0	0000h		
	0.8mA	-3277	F333h	underrange	

CHxUL CHxLL Upper limit value Lower limit value channel x

For each channel an *upper* and a *lower limit* may be defined. Here only values of the nominal range may be preset, otherwise you receive a parameterization error. By presetting 7FFFh for the upper respectively 8000h for the lower limit value the corresponding limit is deactivated. As soon as the measuring value is beyond the limits and the limit value monitoring is activated, a process interrupt is initialized.

3.18.3 Diagnostics and interrupt

Event	Process interrupt	Diagnostics interrupt	parameterizable
Error in project engineering/parameterization	-	X	-
Measuring range overflow	-	X	-
Measuring range underflow	-	X	-
Limit overflow	X	-	X
Limit underflow	X	-	X
Diagnostic buffer overflow	-	X	-
Communication error	-	X	-
Process interrupt lost	-	X	-

Process interrupt

So you may react to asynchronous events, there is the possibility to activate a process interrupt. A process interrupt interrupts the linear program sequence and jumps depending on the master system to a corresponding Interrupt routine. Here you can react to the process interrupt accordingly.

With CANopen the process interrupt data a transferred via an emergency telegram.

Operating with CPU, PROFIBUS and PROFINET the process interrupt data were transferred via diagnostics telegram.

SX - Subindex for access via EtherCAT with Index 5000h

More can be found in the according manual of your bus coupler.

Name	Bytes	Function	Default	SX
PRIT_OL	1	Upper limit overflow channel x	00h	02h
PRIT_UL	1	Lower limit underflow channel x	00h	03h
PRIT_US	2	µs-Ticker	00h	04h (high byte) 05h (low byte)

PRIT_OL Limit overflow

Byte	Bit 7 ... 0
0	<ul style="list-style-type: none"> ■ Bit 0: Limit overflow channel 0 ■ Bit 1: Limit overflow channel 1 ■ Bit 7 ... 2: reserved

PRIT_UL Limit underflow

Byte	Bit 7 ... 0
0	<ul style="list-style-type: none"> ■ Bit 0: Limit underflow channel 0 ■ Bit 1: Limit underflow channel 1 ■ Bit 7 ... 2: reserved

PRIT_US μ s ticker

Byte	Bit 7 ... 0
0 ... 1	Value of the μ s ticker at the moment of the diagnostic.

PRIT_US μ s ticker

In the SLIO module there is a 32 bit timer (μ s ticker). With PowerON the timer starts counting with 0. After 232-1 μ s the timer starts with 0 again. PRIT_US represents the lower 2 byte of the μ s ticker value (0 ... 2¹⁶-1).

Diagnostic data

Via the parameterization you may activate a diagnostic interrupt for the module. With a diagnostics interrupt the module serves for diagnostics data for diagnostic interrupt_{incoming}. As soon as the reason for releasing a diagnostic interrupt is no longer present, the diagnostic interrupt_{going} automatically takes place. All events of a channel between diagnostic interrupt_{incoming} and diagnostic interrupt_{going} are not stored and get lost. Within this time window (1. diagnostic interrupt_{incoming} until last diagnostic interrupt_{going}) the MF-LED of the module is on.

The following errors are listed in the diagnostics data:

- Error in project engineering / parameterization
- Measuring range overflow
- Measuring range underflow
- Process interrupt lost
- Power supply failed

DS - Record set for access via CPU, PROFIBUS and PROFINET. The access happens by DS 01h. Additionally the first 4 bytes may be accessed by DS 00h.

IX - Index for access via CANopen. The access happens by IX 2F01h. Additionally the first 4 bytes may be accessed by IX 2F00h.

SX - Subindex for access via EtherCAT with Index 5005h.

More can be found in the according manual of your bus coupler.

Name	Bytes	Function	Default	DS	IX	SX
ERR_A	1	Diagnostic	00h	01h	2F01h	02h
MODTYP	1	Module information	15h			03h
ERR_C	1	reserved	00h			04h
ERR_D	1	Diagnostic	00h			05h
CHTYP	1	Channel type	71h			06h
NUMBIT	1	Number diagnostic bits per channel	08h			07h
NUMCH	1	Number of channels of a module	02h			08h

031-1CB40 - AI 2x16Bit 0(4)...20mA > Diagnostics and interrupt

Name	Bytes	Function	Default	DS	IX	SX
CHERR	1	Channel error	00h			09h
CH0ERR	1	Channel-specific error channel 0	00h			0Ah
CH1ERR	1	Channel-specific error channel 1	00h			0Bh
CH2ERR...CH7 ERR	6	reserved	00h			0Ch ... 11h
DIAG_US	4	µs ticker	00h			13h

ERR_A Diagnostic

Byte	Bit 7 ... 0
0	<ul style="list-style-type: none"> ■ Bit 0: set at module failure ■ Bit 1: set at internal error ■ Bit 2: set at external error ■ Bit 3: set at channel error ■ Bit 4: set at external auxiliary supply missing ■ Bit 6 ... 5: reserved ■ Bit 7: set at error in parameterization

MODTYP Module information

Byte	Bit 7 ... 0
0	<ul style="list-style-type: none"> ■ Bit 3 ... 0: module class <ul style="list-style-type: none"> – 0101b analog module ■ Bit 4: set at channel information present ■ Bit 7 ... 5: reserved

ERR_D Diagnostic

Byte	Bit 7 ... 0
0	<ul style="list-style-type: none"> ■ Bit 2 ... 0: reserved ■ Bit 3: set at internal diagnostics buffer overflow ■ Bit 4: set at internal communication error ■ Bit 5: reserved ■ Bit 6: set at process interrupt lost ■ Bit 7: reserved

CHTYP Channel type

Byte	Bit 7 ... 0
0	<ul style="list-style-type: none"> ■ Bit 6 ... 0: Channel type <ul style="list-style-type: none"> – 70h: Digital input – 71h: Analog input – 72h: Digital output – 73h: Analog output – 74h: Analog input/output – 76h: Counter ■ Bit 7: reserved

NUMBIT Diagnostic bits

Byte	Bit 7 ... 0
0	Number of diagnostic bits per channel (here 08h)

NUMCH Channels

Byte	Bit 7 ... 0
0	Number of channels of a module (here 02h)

CHERR Channel error

Byte	Bit 7 ... 0
0	<ul style="list-style-type: none"> ■ Bit 0: set at error in channel group 0 ■ Bit 1: set at error in channel group 1 ■ Bit 7 ... 2: reserved

**CH0ERR CH1ERR
Channel-specific**

Byte	Bit 7 ... 0
0	Channel-specific error channel x: <ul style="list-style-type: none"> ■ Bit 0: set at configuring/parameter assignment error ■ Bit 4 ... 1: reserved ■ Bit 5: set at process interrupt lost ■ Bit 6: set at measuring range underflow ■ Bit 7: set at measuring range overflow

**CH2ERR ... CH7ERR
reserved**

Byte	Bit 7 ... 0
0	reserved

DIAG_US μ s ticker

Byte	Bit 7 ... 0
0...3	Value of the μ s ticker at the moment of the diagnostic

 μ s ticker

In the System SLIO module there is a timer (μ s ticker). With PowerON the timer starts counting with 0. After $2^{32}-1\mu$ s the timer starts with 0 again.

3.19 031-1CB70 - AI 2x16Bit ±10V

Properties

The electronic module has 2 inputs with parameterizable functions. The channels of the module are electrically isolated from the backplane bus. In addition, the channels are isolated to the DC 24V power supply by means of DC/DC converter.

- 2 analog inputs
- Suited for sensors with ±10V, 0 ... 10V
- Interrupt and diagnostics function
- Interference frequency suppression parameterizable (50/60Hz)
- 16bit resolution

Structure

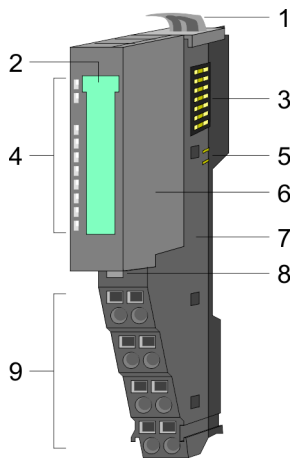

- 1 Locking lever terminal module
- 2 Labeling strip
- 3 Backplane bus
- 4 LED status indication
- 5 DC 24V power section supply
- 6 Electronic module
- 7 Terminal module
- 8 Locking lever electronic module
- 9 Terminal

Status indication

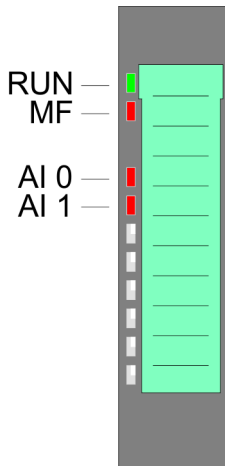

RUN	MF	AI x	Description
■ green	■ red	■ red	
■	<input type="checkbox"/>	X	Bus communication is OK Module status is OK
■	■	X	Bus communication is OK Module status reports an error
<input type="checkbox"/>	■	X	Bus communication is not possible Module status reports an error
<input type="checkbox"/>	<input type="checkbox"/>	X	Error at bus power supply
X	▣ 2Hz	X	Error in configuration Chap. 2.8 'Trouble shooting - LEDs' page 30
■	<input type="checkbox"/>	■	Error channel x <ul style="list-style-type: none"> ■ Signal leaves measuring range ■ Error in parameterization
not relevant: X			

Pin assignment

For wires with a cross section of 0.08mm² up to 1.5mm².

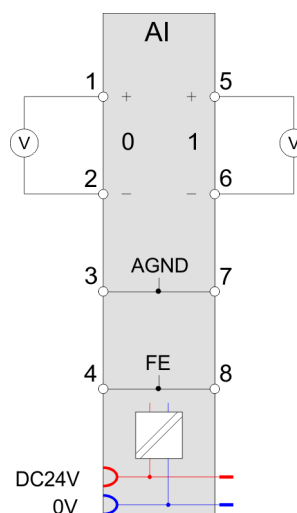
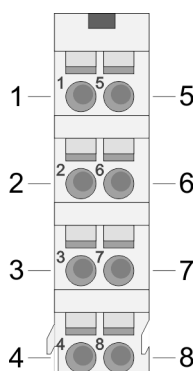

Pos.	Function	Type	Description
1	+AI 0	I	+ Channel 0
2	-AI 0	I	Ground Channel 0
3	AGND	I	Reference potential for differential-mode input
4	FE	I	Functional ground for cable shield (an additional shield bus carrier is not necessary)
5	+AI 1	I	+ Channel 1
6	-AI 1	I	Ground Channel 1
7	AGND	I	Reference potential for differential-mode input
8	FE	I	Functional ground for cable shield (an additional shield bus carrier is not necessary)

I: Input

In-/Output area

At CPU, PROFIBUS and PROFINET the input respectively output area is embedded to the corresponding address area.

IX - Index for access via CANopen with s = Subindex, depends on number and type of analog modules

SX - Subindex for access via EtherCAT with Index 6000h + EtherCAT-Slot

More can be found in the according manual of your bus coupler.

Input area

Addr.	Name	Bytes	Function	IX	SX
+0	AI 0	2	Analog value channel 0	6401h/s	01h
+2	AI 1	2	Analog value channel 1	6401h/s+1	02h

Output area No byte of the output area is used by the module.

3.19.1 Technical data

Order no.	031-1CB70
Type	SM 031
Module ID	040C 1543
Current consumption/power loss	
Current consumption from backplane bus	60 mA
Power loss	0.8 W
Technical data analog inputs	
Number of inputs	2
Cable length, shielded	200 m
Rated load voltage	DC 24 V
Current consumption from load voltage L+ (without load)	20 mA
Voltage inputs	✓
Min. input resistance (voltage range)	200 k Ω
Input voltage ranges	-10 V ... +10 V 0 V ... +10 V
Operational limit of voltage ranges	+/-0.2%
Operational limit of voltage ranges with SFU	-
Basic error limit voltage ranges	+/-0.1%
Basic error limit voltage ranges with SFU	-
Destruction limit voltage	max. 30V
Current inputs	-
Max. input resistance (current range)	-
Input current ranges	-
Operational limit of current ranges	-
Operational limit of current ranges with SFU	-
Basic error limit current ranges	-
Radical error limit current ranges with SFU	-
Destruction limit current inputs (voltage)	-
Destruction limit current inputs (electrical current)	-
Resistance inputs	-
Resistance ranges	-
Operational limit of resistor ranges	-
Operational limit of resistor ranges with SFU	-
Basic error limit	-

Order no.	031-1CB70
Basic error limit with SFU	-
Destruction limit resistance inputs	-
Resistance thermometer inputs	-
Resistance thermometer ranges	-
Operational limit of resistance thermometer ranges	-
Operational limit of resistance thermometer ranges with SFU	-
Basic error limit thermoresistor ranges	-
Basic error limit thermoresistor ranges with SFU	-
Destruction limit resistance thermometer inputs	-
Thermocouple inputs	-
Thermocouple ranges	-
Operational limit of thermocouple ranges	-
Operational limit of thermocouple ranges with SFU	-
Basic error limit thermoelement ranges	-
Basic error limit thermoelement ranges with SFU	-
Destruction limit thermocouple inputs	-
Programmable temperature compensation	-
External temperature compensation	-
Internal temperature compensation	-
Temperature error internal compensation	-
Technical unit of temperature measurement	-
Resolution in bit	16
Measurement principle	successive approximation
Basic conversion time	240 μs all channels
Noise suppression for frequency	>80dB at 50Hz (UCM<9V)
Status information, alarms, diagnostics	
Status display	yes
Interrupts	yes, parameterizable
Process alarm	yes, parameterizable
Diagnostic interrupt	yes, parameterizable
Diagnostic functions	yes
Diagnostics information read-out	possible
Module state	green LED
Module error display	red LED
Channel error display	red LED per channel

031-1CB70 - AI 2x16Bit $\pm 10V$ > Technical data

Order no.	031-1CB70
Isolation	
Between channels	-
Between channels of groups to	-
Between channels and backplane bus	✓
Between channels and power supply	✓
Max. potential difference between circuits	-
Max. potential difference between inputs (Ucm)	DC 9 V
Max. potential difference between Mana and Mintern (Uiso)	-
Max. potential difference between inputs and Mana (Ucm)	DC 1 V
Max. potential difference between inputs and Mintern (Uiso)	DC 75 V/ AC 50 V
Max. potential difference between Mintern and outputs	-
Insulation tested with	DC 500 V
Datasizes	
Input bytes	4
Output bytes	0
Parameter bytes	20
Diagnostic bytes	20
Housing	
Material	PPE / PPE GF10
Mounting	Profile rail 35 mm
Mechanical data	
Dimensions (WxHxD)	12.9 mm x 109 mm x 76.5 mm
Net weight	61 g
Weight including accessories	61 g
Gross weight	75 g
Environmental conditions	
Operating temperature	0 °C to 60 °C
Storage temperature	-25 °C to 70 °C
Certifications	
UL certification	yes
KC certification	yes

SFU - Interference frequency suppression

3.19.2 Parameter data

DS - Record set for access via CPU, PROFIBUS and PROFINET

IX - Index for access via CANopen

SX - Subindex for access via EtherCAT with Index 3100h + EtherCAT-Slot

More can be found in the according manual of your bus coupler.

Name	Bytes	Function	Default	DS	IX	SX
DIAG_EN	1	Diagnostics*	00h	00h	3100h	01h
RES1	1	reserved*	00h	00h	3101h	02h
LIMIT_EN	1	Limit value monitoring*	00h	00h	3102h	03h
SUPR	1	Interference frequency suppression (SFU)	00h	01h	3103h	04h
CH0FN	1	Function number channel 0	12h	80h	3104h	05h
RES7	1	reserved	00h	80h	3105h	06h
CH0UL	2	Upper limit value channel 0	7FFFh	80h	3106h...3107h	07h
CH0LL	2	Lower limit value channel 0	8000h	80h	3108h...3109h	08h
CH1FN	1	Function number channel 1	12h	81h	310Ah	09h
RES13	1	reserved	00h	81h	310Bh	0Ah
CH1UL	2	Upper limit value channel 1	7FFFh	81h	310Ch...310Dh	0Bh
CH1LL	2	Lower limit value channel 1	8000h	81h	310Eh...310Fh	0Ch

* This record set may only be transferred at STOP state.

DIAG_EN Diagnostic interrupt

Byte	Bit 7 ... 0
0	<ul style="list-style-type: none"> ■ Diagnostic interrupt <ul style="list-style-type: none"> – 00h: disabled – 40h: enabled

- Here you can enable respectively disable the diagnostic interrupt.

LIMIT_EN Limit value monitoring

Byte	Bit 7 ... 0
0	<ul style="list-style-type: none"> ■ Bit 0: Limit value monitoring channel 0 (1: on) ■ Bit 1: Limit value monitoring channel 1 (1: on) ■ Bit 7 ... 2: reserved

SUPR Interference frequency suppression (SFU)

Byte	Bit 7 ... 0
0	<ul style="list-style-type: none"> ■ Bit 1, 0: Interference frequency suppression channel 0 <ul style="list-style-type: none"> – 00: deactivated – 01: 60Hz – 10: 50Hz ■ Bit 3, 2: Interference frequency suppression channel 1 <ul style="list-style-type: none"> – 00: deactivated – 01: 60Hz – 10: 50Hz ■ Bit 7 ... 4: reserved

CHxFN Function number channel x

In the following there are the measuring ranges with function number listed, which were supported by the analog module. With FFh the corresponding channel is deactivated. The formulas listed here allow you to transform an evaluated measuring value (digital value) to a value assigned to the measuring range (analog value) and vice versa.

±10V

Meas. range (funct. no.)	Voltage (U)	Decimal (D)	Hex	Range	Formulas
±10V Siemens S7 format (12h)	11.76V	32511	7EFFh	overrange	$D = 27648 \cdot \frac{U}{10}$ $U = D \cdot \frac{10}{27648}$
	10V	27648	6C00h	nominal range	
	5V	13824	3600h		
	0V	0	0000h		
	-5V	-13824	CA00h	underrange	
	-10V	-27648	9400h		
	-11.76V	-32512	8100h		
±10V Siemens S5 format (22h)	12.5V	20480	5000h	overrange	$D = 16384 \cdot \frac{U}{10}$ $U = D \cdot \frac{10}{16384}$
	10V	16384	4000h	nominal range	
	5V	8192	2000h		
	0V	0	0000h		
	-5V	-8192	E000h	underrange	
	-10V	-16384	C000h		
	-12.5V	-20480	B000h		

0 ... 10V

Meas. range (funct. no.)	Voltage (U)	Decimal (D)	Hex	Range	Formulas
0 ... 10V Siemens S7 format (10h)	11.76V	32511	7EFFh	overrange	$D = 27648 \cdot \frac{U}{10}$ $U = D \cdot \frac{10}{27648}$
	10V	27648	6C00h	nominal range	
	5V	13824	3600h		
	0V	0	0000h		
	-1.76V	-4864	ED00h	underrange	
0 ... 10V Siemens S5 format (20h)	12.5V	20480	5000h	overrange	$D = 16384 \cdot \frac{U}{10}$ $U = D \cdot \frac{10}{16384}$
	10V	16384	4000h	nominal range	
	5V	8192	2000h		
	0V	0	0000h		
	-2V	-3277	F333h	underrange	

**CHxUL / CHxLL Upper
limit value Lower limit
value channel x**

For each channel an *upper* and a *lower limit* may be defined. Here only values of the nominal range may be preset, otherwise you receive a parameterization error. By presetting 7FFFh for the upper respectively 8000h for the lower limit value the corresponding limit is deactivated. As soon as the measuring value is beyond the limits and the limit value monitoring is activated, a process interrupt is initialized.

3.19.3 Diagnostics and interrupt

Event	Process interrupt	Diagnostics interrupt	parameterizable
Error in project engineering/parameterization	-	X	-
Measuring range overflow	-	X	-
Measuring range underflow	-	X	-
Limit overflow	X	-	X
Limit underflow	X	-	X
Diagnostic buffer overflow	-	X	-
Communication error	-	X	-
Process interrupt lost	-	X	-

Process interrupt

So you may react to asynchronous events, there is the possibility to activate a process interrupt. A process interrupt interrupts the linear program sequence and jumps depending on the master system to a corresponding Interrupt routine. Here you can react to the process interrupt accordingly.

With CANopen the process interrupt data a transferred via an emergency telegram.

Operating with CPU, PROFIBUS and PROFINET the process interrupt data were transferred via diagnostics telegram.

SX - Subindex for access via EtherCAT with Index 5000h

More can be found in the according manual of your bus coupler.

Name	Bytes	Function	Default	SX
PRIT_OL	1	Upper limit overflow channel x	00h	02h
PRIT_UL	1	Lower limit underflow channel x	00h	03h
PRIT_US	2	µs-Ticker	00h	04h (high byte) 05h (low byte)

PRIT_OL Limit overflow

Byte	Bit 7 ... 0
0	<ul style="list-style-type: none"> ■ Bit 0: Limit overflow channel 0 ■ Bit 1: Limit overflow channel 1 ■ Bit 7 ... 2: reserved

PRIT_UL Limit underflow

Byte	Bit 7 ... 0
0	<ul style="list-style-type: none"> ■ Bit 0: Limit underflow channel 0 ■ Bit 1: Limit underflow channel 1 ■ Bit 7 ... 2: reserved

PRIT_US μ s ticker

Byte	Bit 7 ... 0
0 ... 1	Value of the μ s ticker at the moment of the diagnostic.

 μ s-ticker

In the SLIO module there is a 32 bit timer (μ s ticker). With PowerON the timer starts counting with 0. After $2^{32}-1\mu$ s the timer starts with 0 again. PRIT_US represents the lower 2 byte of the μ s ticker value (0 ... $2^{16}-1$).

Diagnostic data

Via the parameterization you may activate a diagnostic interrupt for the module. With a diagnostics interrupt the module serves for diagnostics data for diagnostic interrupt_{incoming}. As soon as the reason for releasing a diagnostic interrupt is no longer present, the diagnostic interrupt_{going} automatically takes place. All events of a channel between diagnostic interrupt_{incoming} and diagnostic interrupt_{going} are not stored and get lost. Within this time window (1. diagnostic interrupt_{incoming} until last diagnostic interrupt_{going}) the MF-LED of the module is on.

The following errors are listed in the diagnostics data:

- Error in project engineering / parameterization
- Measuring range overflow
- Measuring range underflow
- Process interrupt lost
- Power supply failed

DS - Record set for access via CPU, PROFIBUS and PROFINET. The access happens by DS 01h. Additionally the first 4 bytes may be accessed by DS 00h.

IX - Index for access via CANopen. The access happens by IX 2F01h. Additionally the first 4 bytes may be accessed by IX 2F00h.

SX - Subindex for access via EtherCAT with Index 5005h.

More can be found in the according manual of your bus coupler.

Name	Bytes	Function	Default	DS	IX	SX
ERR_A	1	Diagnostic	00h	01h	2F01h	02h
MODTYP	1	Module information	15h			03h
ERR_C	1	reserved	00h			04h
ERR_D	1	Diagnostic	00h			05h
CHTYP	1	Channel type	71h			06h
NUMBIT	1	Number diagnostic bits per channel	08h			07h
NUMCH	1	Number of channels of a module	02h			08h
CHERR	1	Channel error	00h			09h
CH0ERR	1	Channel-specific error channel 0	00h			0Ah
CH1ERR	1	Channel-specific error channel 1	00h			0Bh
CH2ERR... CH7ERR	6	reserved	00h			0Ch ... 11h
DIAG_US	4	μ s ticker	00h			13h

ERR_A Diagnostic

Byte	Bit 7 ... 0
0	<ul style="list-style-type: none"> ■ Bit 0: set at module failure ■ Bit 1: set at internal error ■ Bit 2: set at external error ■ Bit 3: set at channel error ■ Bit 4: set at external auxiliary supply missing ■ Bit 6 ... 5: reserved ■ Bit 7: set at error in parameterization

MODTYP Module information

Byte	Bit 7 ... 0
0	<ul style="list-style-type: none"> ■ Bit 3 ... 0: module class <ul style="list-style-type: none"> – 0101b analog module ■ Bit 4: set at channel information present ■ Bit 7 ... 5: reserved

ERR_D Diagnostic

Byte	Bit 7 ... 0
0	<ul style="list-style-type: none"> ■ Bit 2 ... 0: reserved ■ Bit 3: set at internal diagnostics buffer overflow ■ Bit 4: set at internal communication error ■ Bit 5: reserved ■ Bit 6: set at process interrupt lost ■ Bit 7: reserved

CHTYP Channel type

Byte	Bit 7 ... 0
0	<ul style="list-style-type: none"> ■ Bit 6 ... 0: Channel type <ul style="list-style-type: none"> – 70h: Digital input – 71h: Analog input – 72h: Digital output – 73h: Analog output – 74h: Analog input/-output – 76h: Counter ■ Bit 7: reserved

NUMBIT Diagnostic bits

Byte	Bit 7 ... 0
0	Number of diagnostic bits per channel (here 08h)

NUMCH Channels

Byte	Bit 7 ... 0
0	Number of channels of a module (here 02h)

CHERR Channel error

Byte	Bit 7 ... 0
0	<ul style="list-style-type: none"> ■ Bit 0: set at error in channel group 0 ■ Bit 1: set at error in channel group 1 ■ Bit 7 ... 2: reserved

**CH0ERR/CH1ERR
Channel-specific**

Byte	Bit 7 ... 0
0	Channel-specific error channel x: <ul style="list-style-type: none"> ■ Bit 0: set at configuring/parameter assignment error ■ Bit 4 ... 1: reserved ■ Bit 5: set at process interrupt lost ■ Bit 6: set at measuring range underflow ■ Bit 7: set at measuring range overflow

**CH2ERR ... CH7ERR
reserved**

Byte	Bit 7 ... 0
0	reserved

DIAG_US μs ticker

Byte	Bit 7 ... 0
0...3	Value of the μs ticker at the moment of the diagnostic

μs ticker

In the System SLIO module there is a timer (μs ticker). With PowerON the timer starts counting with 0. After $2^{32}-1\mu\text{s}$ the timer starts with 0 again.

3.20 031-1CD30 - AI 4x16Bit 0...10V

Properties

The electronic module has 4 inputs with parameterizable functions. The channels of the module are electrically isolated from the backplane bus. In addition, the channels are isolated to the DC 24V power supply by means of DC/DC converter.

- 4 analog inputs
- Suited for sensors with 0 ... 10V
- Interrupt and diagnostics function
- Interference frequency suppression parameterizable (50/60Hz)
- 16bit resolution
- ↗ *Chap. 3.21 '031-1CD35 - AI 4x16Bit 0...10V' page 241* with limited parameter set

Structure

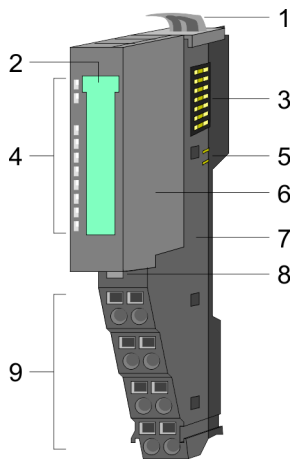

- 1 Locking lever terminal module
- 2 Labeling strip
- 3 Backplane bus
- 4 LED status indication
- 5 DC 24V power section supply
- 6 Electronic module
- 7 Terminal module
- 8 Locking lever electronic module
- 9 Terminal

Status indication

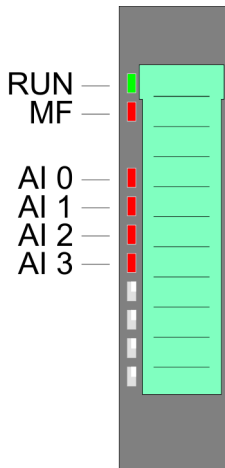

RUN ■ green	MF ■ red	AI x ■ red	Description
■	□	X	Bus communication is OK Module status is OK
■	■	X	Bus communication is OK Module status reports an error
□	■	X	Bus communication is not possible Module status reports an error
□	□	X	Error at bus power supply
X	▣ 2Hz	X	Error in configuration ↗ <i>Chap. 2.8 'Trouble shooting - LEDs' page 30</i>
■	□	■	Error channel x <ul style="list-style-type: none"> ■ Signal leaves measuring range ■ Error in parameterization
not relevant: X			

Pin assignment

For wires with a cross section of 0.08mm² up to 1.5mm².

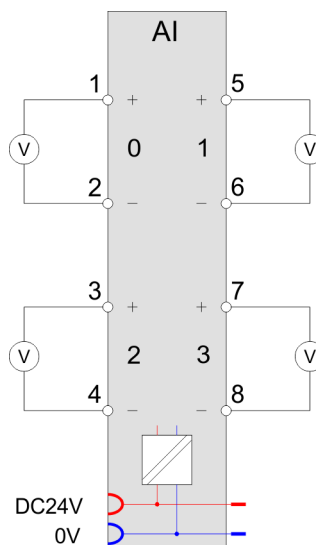
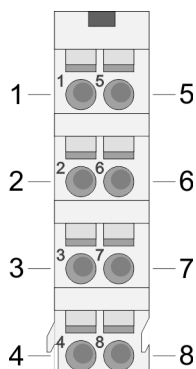

Pos.	Function	Type	Description
1	+AI 0	I	+ Channel 0
2	-AI 0	I	Ground Channel 0
3	+AI 2	I	+ Channel 2
4	-AI 2	I	Ground Channel 2
5	+AI 1	I	+ Channel 1
6	-AI 1	I	Ground Channel 1
7	+AI 3	I	+ Channel 3
8	-AI 3	I	Ground Channel 3

I: Input

In-/Output area

At CPU, PROFIBUS and PROFINET the input respectively output area is embedded to the corresponding address area.

IX - Index for access via CANopen with s = Subindex, depends on number and type of analog modules

SX - Subindex for access via EtherCAT with Index 6000h + EtherCAT-Slot

More can be found in the according manual of your bus coupler.

Input area

Addr.	Name	Bytes	Function	IX	SX
+0	AI 0	2	Analog value channel 0	6401h/s	01h
+2	AI 1	2	Analog value channel 1	6401h/s+1	02h
+4	AI 2	2	Analog value channel 2	6401h/s+2	03h
+6	AI 3	2	Analog value channel 3	6401h/s+3	04h

Output area No byte of the output area is used by the module.

3.20.1 Technical data

Order no.	031-1CD30
Type	SM 031
Module ID	040D 1544
Current consumption/power loss	
Current consumption from backplane bus	65 mA
Power loss	0.9 W
Technical data analog inputs	
Number of inputs	4
Cable length, shielded	200 m
Rated load voltage	DC 24 V
Current consumption from load voltage L+ (without load)	25 mA
Voltage inputs	✓
Min. input resistance (voltage range)	200 kΩ
Input voltage ranges	0 V ... +10 V
Operational limit of voltage ranges	+/-0.2%
Operational limit of voltage ranges with SFU	-
Basic error limit voltage ranges	+/-0.1%
Basic error limit voltage ranges with SFU	-
Destruction limit voltage	max. 30V
Current inputs	-
Max. input resistance (current range)	-
Input current ranges	-
Operational limit of current ranges	-
Operational limit of current ranges with SFU	-
Basic error limit current ranges	-
Radical error limit current ranges with SFU	-
Destruction limit current inputs (voltage)	-
Destruction limit current inputs (electrical current)	-
Resistance inputs	-
Resistance ranges	-
Operational limit of resistor ranges	-
Operational limit of resistor ranges with SFU	-
Basic error limit	-
Basic error limit with SFU	-

Order no.	031-1CD30
Destruction limit resistance inputs	-
Resistance thermometer inputs	-
Resistance thermometer ranges	-
Operational limit of resistance thermometer ranges	-
Operational limit of resistance thermometer ranges with SFU	-
Basic error limit thermoresistor ranges	-
Basic error limit thermoresistor ranges with SFU	-
Destruction limit resistance thermometer inputs	-
Thermocouple inputs	-
Thermocouple ranges	-
Operational limit of thermocouple ranges	-
Operational limit of thermocouple ranges with SFU	-
Basic error limit thermoelement ranges	-
Basic error limit thermoelement ranges with SFU	-
Destruction limit thermocouple inputs	-
Programmable temperature compensation	-
External temperature compensation	-
Internal temperature compensation	-
Temperature error internal compensation	-
Technical unit of temperature measurement	-
Resolution in bit	16
Measurement principle	successive approximation
Basic conversion time	480 µs all channels
Noise suppression for frequency	>80dB at 50Hz (UCM<9V)
Status information, alarms, diagnostics	
Status display	yes
Interrupts	yes, parameterizable
Process alarm	yes, parameterizable
Diagnostic interrupt	yes, parameterizable
Diagnostic functions	yes
Diagnostics information read-out	possible
Module state	green LED
Module error display	red LED
Channel error display	red LED per channel
Isolation	

031-1CD30 - AI 4x16Bit 0...10V > Technical data

Order no.	031-1CD30
Between channels	-
Between channels of groups to	-
Between channels and backplane bus	✓
Between channels and power supply	✓
Max. potential difference between circuits	-
Max. potential difference between inputs (Ucm)	DC 9 V
Max. potential difference between Mana and Mintern (Uiso)	-
Max. potential difference between inputs and Mana (Ucm)	-
Max. potential difference between inputs and Mintern (Uiso)	DC 75 V/ AC 50 V
Max. potential difference between Mintern and outputs	-
Insulation tested with	DC 500 V
Datasizes	
Input bytes	8
Output bytes	0
Parameter bytes	32
Diagnostic bytes	20
Housing	
Material	PPE / PPE GF10
Mounting	Profile rail 35 mm
Mechanical data	
Dimensions (WxHxD)	12.9 mm x 109 mm x 76.5 mm
Net weight	61 g
Weight including accessories	61 g
Gross weight	75 g
Environmental conditions	
Operating temperature	0 °C to 60 °C
Storage temperature	-25 °C to 70 °C
Certifications	
UL certification	yes
KC certification	yes

SFU - Interference frequency suppression

3.20.2 Parameter data

DS - Record set for access via CPU, PROFIBUS and PROFINET

IX - Index for access via CANopen

SX - Subindex for access via EtherCAT with Index 3100h + EtherCAT-Slot

More can be found in the according manual of your bus coupler.

Name	Bytes	Function	Default	DS	IX	SX
DIAG_EN	1	Diagnostics*	00h	00h	3100h	01h
RES1	1	reserved*	00h	00h	3101h	02h
LIMIT_EN	1	Limit value monitoring*	00h	00h	3102h	03h
SUPR	1	Interference frequency suppression (SFU)	00h	01h	3103h	04h
CH0FN	1	Function number channel 0	10h	80h	3104h	05h
RES7	1	reserved	00h	80h	3105h	06h
CH0UL	2	Upper limit value channel 0	7FFFh	80h	3106h...3107h	07h
CH0LL	2	Lower limit value channel 0	8000h	80h	3108h...3109h	08h
CH1FN	1	Function number channel 1	10h	81h	310Ah	09h
RES13	1	reserved	00h	81h	310Bh	0Ah
CH1UL	2	Upper limit value channel 1	7FFFh	81h	310Ch...310Dh	0Bh
CH1LL	2	Lower limit value channel 1	8000h	81h	310Eh...310Fh	0Ch
CH2FN	1	Function number channel 2	10h	82h	3110h	0Dh
RES19	1	reserved	00h	82h	3111h	0Eh
CH2UL	2	Upper limit value channel 2	7FFFh	82h	3112h...3113h	0Fh
CH2LL	2	Lower limit value channel 2	8000h	82h	3114h...3115h	10h
CH3FN	1	Function number channel 3	10h	83h	3116h	11h
RES25	1	reserved	00h	83h	3117h	12h
CH3UL	2	Upper limit value channel 3	7FFFh	83h	3118h...3119h	13h
CH3LL	2	Lower limit value channel 3	8000h	83h	311Ah...311Bh	14h

* This record set may only be transferred at STOP state.

DIAG_EN Diagnostic interrupt

Byte	Bit 7 ... 0
0	<ul style="list-style-type: none"> ■ Diagnostic interrupt <ul style="list-style-type: none"> – 00h: disabled – 40h: enabled

■ Here you can enable respectively disable the diagnostic interrupt.

LIMIT_EN Limit value monitoring

Byte	Bit 7 ... 0
0	<ul style="list-style-type: none"> ■ Bit 0: Limit value monitoring channel 0 (1: on) ■ Bit 1: Limit value monitoring channel 1 (1: on) ■ Bit 2: Limit value monitoring channel 2 (1: on) ■ Bit 3: Limit value monitoring channel 3 (1: on) ■ Bit 7 ... 4: reserved

SUPR Interference frequency suppression (SFU)

Byte	Bit 7 ... 0
0	<ul style="list-style-type: none"> ■ Bit 1, 0: Interference frequency suppression channel 0 ■ Bit 3, 2: Interference frequency suppression channel 1 ■ Bit 5, 4: Interference frequency suppression channel 2 ■ Bit 7, 6: Interference frequency suppression channel 3 <ul style="list-style-type: none"> – 00: deactivated – 01: 60Hz – 10: 50Hz <p>e.g.: 10101010: all channels frequency suppression 50Hz</p>

CHxFN Function number channel x

In the following there are the measuring ranges with corresponding function number listed, which were supported by the analog module. With FFh the corresponding channel is deactivated. The formulas listed here allow you to transform an evaluated measuring value (digital value) to a value assigned to the measuring range (analog value) and vice versa.

0 ... 10V

Meas. range (funct. no.)	Voltage (U)	Decimal (D)	Hex	Range	Formulas
0 ... 10V Siemens S7 format (10h)	11.76V	32511	7EFFh	overrange	$D = 27648 \cdot \frac{U}{10}$ $U = D \cdot \frac{10}{27648}$
	10V	27648	6C00h	nominal range	
	5V	13824	3600h		
	0V	0	0000h		
0 ... 10V Siemens S5 format (20h)	-1.76V	-4864	ED00h	underrange	$D = 16384 \cdot \frac{U}{10}$ $U = D \cdot \frac{10}{16384}$
	12.5V	20480	5000h	overrange	
	10V	16384	4000h	nominal range	
	5V	8192	2000h		
	0V	0	0000h		
	-2V	-3277	F333h	underrange	

CHxUL CHxLL Upper limit value Lower limit value channel x

For each channel an *upper* and a *lower limit* may be defined. Here only values of the nominal range may be preset, otherwise you receive a parameterization error. By presetting 7FFFh for the upper respectively 8000h for the lower limit value the corresponding limit is deactivated. As soon as the measuring value is beyond the limits and the limit value monitoring is activated, a process interrupt is initialized.

3.20.3 Diagnostics and interrupt

Event	Process interrupt	Diagnostics interrupt	parameterizable
Error in project engineering/parameterization	-	X	-
Measuring range overflow	-	X	-
Measuring range underflow	-	X	-
Limit overflow	X	-	X
Limit underflow	X	-	X
Diagnostic buffer overflow	-	X	-
Communication error	-	X	-
Process interrupt lost	-	X	-

Process interrupt

So you may react to asynchronous events, there is the possibility to activate a process interrupt. A process interrupt interrupts the linear program sequence and jumps depending on the master system to a corresponding Interrupt routine. Here you can react to the process interrupt accordingly.

With CANopen the process interrupt data a transferred via an emergency telegram.

Operating with CPU, PROFIBUS and PROFINET the process interrupt data were transferred via diagnostics telegram.

SX - Subindex for access via EtherCAT with Index 5000h

More can be found in the according manual of your bus coupler.

Name	Bytes	Function	Default	SX
PRIT_OL	1	Upper limit overflow channel x	00h	02h
PRIT_UL	1	Lower limit underflow channel x	00h	03h
PRIT_US	2	µs-Ticker	00h	04h (high byte) 05h (low byte)

PRIT_OL Limit overflow

Byte	Bit 7 ... 0
0	<ul style="list-style-type: none"> ■ Bit 0: Limit overflow channel 0 ■ Bit 1: Limit overflow channel 1 ■ Bit 2: Limit overflow channel 2 ■ Bit 3: Limit overflow channel 3 ■ Bit 7 ... 4: reserved

PRIT_UL Limit underflow

Byte	Bit 7 ... 0
0	<ul style="list-style-type: none"> ■ Bit 0: Limit underflow channel 0 ■ Bit 1: Limit underflow channel 1 ■ Bit 2: Limit underflow channel 2 ■ Bit 3: Limit underflow channel 3 ■ Bit 7 ... 4: reserved

PRIT_US μ s ticker

Byte	Bit 7 ... 0
0 ... 1	Value of the μ s ticker at the moment of the diagnostic.

μ s ticker

In the SLIO module there is a 32 bit timer (μ s ticker). With PowerON the timer starts counting with 0. After $2^{32}-1\mu$ s the timer starts with 0 again. PRIT_US represents the lower 2 byte of the μ s ticker value ($0 \dots 2^{16}-1$).

Diagnostic data

Via the parameterization you may activate a diagnostic interrupt for the module. With a diagnostics interrupt the module serves for diagnostics data for diagnostic interrupt_{incoming}. As soon as the reason for releasing a diagnostic interrupt is no longer present, the diagnostic interrupt_{going} automatically takes place. All events of a channel between diagnostic interrupt_{incoming} and diagnostic interrupt_{going} are not stored and get lost. Within this time window (1. diagnostic interrupt_{incoming} until last diagnostic interrupt_{going}) the MF-LED of the module is on.

The following errors are listed in the diagnostics data:

- Error in project engineering / parameterization
- Measuring range overflow
- Measuring range underflow
- Process interrupt lost
- Power supply failed

DS - Record set for access via CPU, PROFIBUS and PROFINET. The access happens by DS 01h. Additionally the first 4 bytes may be accessed by DS 00h.

IX - Index for access via CANopen. The access happens by IX 2F01h. Additionally the first 4 bytes may be accessed by IX 2F00h.

SX - Subindex for access via EtherCAT with Index 5005h.

More can be found in the according manual of your bus coupler.

Name	Bytes	Function	Default	DS	IX	SX
ERR_A	1	Diagnostic	00h	01h	2F01h	02h
MODTYP	1	Module information	15h			03h
ERR_C	1	reserved	00h			04h
ERR_D	1	Diagnostic	00h			05h
CHTYP	1	Channel type	71h			06h
NUMBIT	1	Number diagnostic bits per channel	08h			07h

Name	Bytes	Function	Default	DS	IX	SX
NUMCH	1	Number of channels of a module	04h			08h
CHERR	1	Channel error	00h			09h
CH0ERR	1	Channel-specific error channel 0	00h			0Ah
CH1ERR	1	Channel-specific error channel 1	00h			0Bh
CH2ERR	1	Channel-specific error channel 2	00h			0Ch
CH3ERR	1	Channel-specific error channel 3	00h			0Dh
CH4ERR...CH7ERR	4	reserved	00h			0Eh ... 11h
DIAG_US	4	µs ticker	00h			13h

ERR_A Diagnostic

Byte	Bit 7 ... 0
0	<ul style="list-style-type: none"> ■ Bit 0: set at module failure ■ Bit 1: set at internal error ■ Bit 2: set at external error ■ Bit 3: set at channel error ■ Bit 4: set at external auxiliary supply missing ■ Bit 6 ... 5: reserved ■ Bit 7: set at error in parameterization

MODTYP Module information

Byte	Bit 7 ... 0
0	<ul style="list-style-type: none"> ■ Bit 3 ... 0: module class <ul style="list-style-type: none"> – 0101b analog module ■ Bit 4: set at channel information present ■ Bit 7 ... 5: reserved

ERR_D Diagnostic

Byte	Bit 7 ... 0
0	<ul style="list-style-type: none"> ■ Bit 2 ... 0: reserved ■ Bit 3: set at internal diagnostics buffer overflow ■ Bit 4: set at internal communication error ■ Bit 5: reserved ■ Bit 6: set at process interrupt lost ■ Bit 7: reserved

CHTYP Channel type

Byte	Bit 7 ... 0
0	<ul style="list-style-type: none"> ■ Bit 6 ... 0: Channel type <ul style="list-style-type: none"> – 70h: Digital input – 71h: Analog input – 72h: Digital output – 73h: Analog output – 74h: Analog input/-output – 76h: Counter ■ Bit 7: reserved

NUMBIT Diagnostic bits

Byte	Bit 7 ... 0
0	Number of diagnostic bits per channel (here 08h)

NUMCH Channels

Byte	Bit 7 ... 0
0	Number of channels of a module (here 04h)

CHERR Channel error

Byte	Bit 7 ... 0
0	<ul style="list-style-type: none"> ■ Bit 0: set at error in channel group 0 ■ Bit 1: set at error in channel group 1 ■ Bit 2: set at error in channel group 2 ■ Bit 3: set at error in channel group 3 ■ Bit 7 ... 4: reserved

**CH0ERR ... CH3ERR
Channel-specific**

Byte	Bit 7 ... 0
0	Channel-specific error channel x: <ul style="list-style-type: none"> ■ Bit 0: set at configuring/parameter assignment error ■ Bit 4 ... 1: reserved ■ Bit 5: set at process interrupt lost ■ Bit 6: set at measuring range underflow ■ Bit 7: set at measuring range overflow

**CH4ERR ... CH7ERR
reserved**

Byte	Bit 7 ... 0
0	reserved

DIAG_US μ s ticker

Byte	Bit 7 ... 0
0...3	Value of the μ s ticker at the moment of the diagnostic

 μ s ticker

In the System SLIO module there is a timer (μ s ticker). With PowerON the timer starts counting with 0. After $2^{32}-1\mu$ s the timer starts with 0 again.

3.21 031-1CD35 - AI 4x16Bit 0...10V

Properties

The electronic module has 4 inputs with parameterizable functions. The channels of the module are electrically isolated from the backplane bus. In addition, the channels are isolated to the DC 24V power supply by means of DC/DC converter.

- 4 analog inputs
- Suited for sensors with 0 ... 10V
- Diagnostics function
- Interference frequency suppression parameterizable (50/60Hz)
- 16bit resolution
- ↗ *Chap. 3.20 '031-1CD30 - AI 4x16Bit 0...10V' page 230* with extended parameter set

Structure

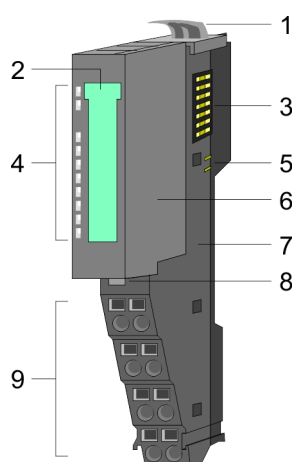

- 1 Locking lever terminal module
- 2 Labeling strip
- 3 Backplane bus
- 4 LED status indication
- 5 DC 24V power section supply
- 6 Electronic module
- 7 Terminal module
- 8 Locking lever electronic module
- 9 Terminal

Status indication

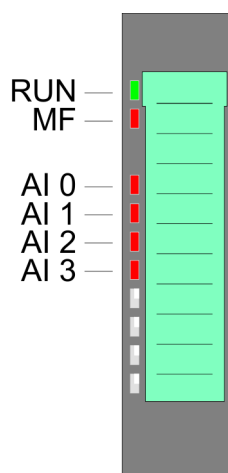

RUN	MF	AI x	Description
<input checked="" type="checkbox"/> green	<input checked="" type="checkbox"/> red	<input checked="" type="checkbox"/> red	
<input checked="" type="checkbox"/>	<input type="checkbox"/>	X	Bus communication is OK Module status is OK
<input checked="" type="checkbox"/>	<input checked="" type="checkbox"/>	X	Bus communication is OK Module status reports an error
<input type="checkbox"/>	<input checked="" type="checkbox"/>	X	Bus communication is not possible Module status reports an error
<input type="checkbox"/>	<input type="checkbox"/>	X	Error at bus power supply
X	<input checked="" type="checkbox"/> 2Hz	X	Error in configuration ↗ <i>Chap. 2.8 'Trouble shooting - LEDs' page 30</i>
<input checked="" type="checkbox"/>	<input type="checkbox"/>	<input checked="" type="checkbox"/>	Error channel x <ul style="list-style-type: none"> ■ Signal leaves measuring range ■ Error in parameterization
not relevant: X			

Pin assignment

For wires with a cross section of 0.08mm² up to 1.5mm².

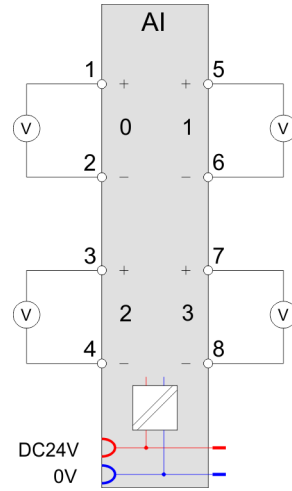
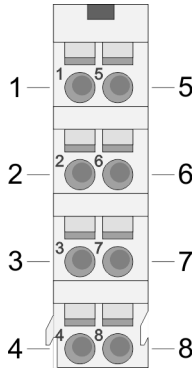

Pos.	Function	Type	Description
1	+AI 0	I	+ Channel 0
2	-AI 0	I	Ground Channel 0
3	+AI 2	I	+ Channel 2
4	-AI 2	I	Ground Channel 2
5	+AI 1	I	+ Channel 1
6	-AI 1	I	Ground Channel 1
7	+AI 3	I	+ Channel 3
8	-AI 3	I	Ground Channel 3

I: Input

In-/Output area

At CPU, PROFIBUS and PROFINET the input respectively output area is embedded to the corresponding address area.

IX - Index for access via CANopen with s = Subindex, depends on number and type of analog modules

SX - Subindex for access via EtherCAT with Index 6000h + EtherCAT-Slot

More can be found in the according manual of your bus coupler.

Input area

Addr.	Name	Bytes	Function	IX	SX
+0	AI 0	2	Analog value channel 0	6401h/s	01h
+2	AI 1	2	Analog value channel 1	6401h/s+1	02h
+4	AI 2	2	Analog value channel 2	6401h/s+2	03h
+6	AI 3	2	Analog value channel 3	6401h/s+3	04h

Output area

No byte of the output area is used by the module.

3.21.1 Technical data

Order no.	031-1CD35
Type	SM 031
Module ID	0413 15C4
Current consumption/power loss	
Current consumption from backplane bus	65 mA
Power loss	0.9 W
Technical data analog inputs	
Number of inputs	4
Cable length, shielded	200 m
Rated load voltage	DC 24 V
Current consumption from load voltage L+ (without load)	25 mA
Voltage inputs	✓
Min. input resistance (voltage range)	200 kΩ
Input voltage ranges	0 V ... +10 V
Operational limit of voltage ranges	+/-0.2%
Operational limit of voltage ranges with SFU	-
Basic error limit voltage ranges	+/-0.1%
Basic error limit voltage ranges with SFU	-
Destruction limit voltage	max. 30V
Current inputs	-
Max. input resistance (current range)	-
Input current ranges	-
Operational limit of current ranges	-
Operational limit of current ranges with SFU	-
Basic error limit current ranges	-
Radical error limit current ranges with SFU	-
Destruction limit current inputs (voltage)	-
Destruction limit current inputs (electrical current)	-
Resistance inputs	-
Resistance ranges	-
Operational limit of resistor ranges	-
Operational limit of resistor ranges with SFU	-
Basic error limit	-
Basic error limit with SFU	-
Destruction limit resistance inputs	-
Resistance thermometer inputs	-

Order no.	031-1CD35
Resistance thermometer ranges	-
Operational limit of resistance thermometer ranges	-
Operational limit of resistance thermometer ranges with SFU	-
Basic error limit thermoresistor ranges	-
Basic error limit thermoresistor ranges with SFU	-
Destruction limit resistance thermometer inputs	-
Thermocouple inputs	-
Thermocouple ranges	-
Operational limit of thermocouple ranges	-
Operational limit of thermocouple ranges with SFU	-
Basic error limit thermoelement ranges	-
Basic error limit thermoelement ranges with SFU	-
Destruction limit thermocouple inputs	-
Programmable temperature compensation	-
External temperature compensation	-
Internal temperature compensation	-
Temperature error internal compensation	-
Technical unit of temperature measurement	-
Resolution in bit	16
Measurement principle	successive approximation
Basic conversion time	480 µs all channels
Noise suppression for frequency	>80dB at 50Hz (UCM<9V)
Status information, alarms, diagnostics	
Status display	yes
Interrupts	no
Process alarm	no
Diagnostic interrupt	no
Diagnostic functions	yes
Diagnostics information read-out	possible
Module state	green LED
Module error display	red LED
Channel error display	red LED per channel
Isolation	
Between channels	-
Between channels of groups to	-

Order no.	031-1CD35
Between channels and backplane bus	✓
Between channels and power supply	✓
Max. potential difference between circuits	-
Max. potential difference between inputs (Ucm)	DC 9 V
Max. potential difference between Mana and Mintern (Uiso)	-
Max. potential difference between inputs and Mana (Ucm)	-
Max. potential difference between inputs and Mintern (Uiso)	DC 75 V/ AC 50 V
Max. potential difference between Mintern and outputs	-
Insulation tested with	DC 500 V
Technical data encoder supply	
Number of outputs	-
Output voltage (typ)	-
Output voltage (rated value)	-
Short-circuit protection	-
Binding of potential	-
Datasizes	
Input bytes	8
Output bytes	0
Parameter bytes	9
Diagnostic bytes	20
Housing	
Material	PPE / PPE GF10
Mounting	Profile rail 35 mm
Mechanical data	
Dimensions (WxHxD)	12.9 mm x 109 mm x 76.5 mm
Net weight	61 g
Weight including accessories	61 g
Gross weight	75 g
Environmental conditions	
Operating temperature	0 °C to 60 °C
Storage temperature	-25 °C to 70 °C
Certifications	
UL certification	yes
KC certification	yes

SFU - Interference frequency suppression

3.21.2 Parameter data

DS - Record set for access via CPU, PROFIBUS and PROFINET

IX - Index for access via CANopen

SX - Subindex for access via EtherCAT with Index 3100h + EtherCAT-Slot

More can be found in the according manual of your bus coupler.

Name	Bytes	Function	Default	DS	IX	SX
SUPR	1	Interference frequency suppression	00h	01h	3100h	01h
CH0FN	1	Function number channel 0	10h	80h	3101h	02h
CH1FN	1	Function number channel 1	10h	81h	3102h	03h
CH2FN	1	Function number channel 2	10h	82h	3103h	04h
CH3FN	1	Function number channel 3	10h	83h	3104h	05h

SUPR Interference frequency suppression (SFU)

Byte	Bit 7 ... 0
0	<ul style="list-style-type: none"> ■ Bit 1, 0: Interference frequency suppression channel 0 ■ Bit 3, 2: Interference frequency suppression channel 1 ■ Bit 5, 4: Interference frequency suppression channel 2 ■ Bit 7, 6: Interference frequency suppression channel 3 <ul style="list-style-type: none"> – 00: deactivated – 01: 60Hz – 10: 50Hz <p>e.g.: 10101010: all channels frequency suppression 50Hz</p>

CHxFN Function number channel x

In the following there are the measuring ranges with corresponding function number listed, which were supported by the analog module. With FFh the corresponding channel is deactivated. The formulas listed here allow you to transform an evaluated measuring value (digital value) to a value assigned to the measuring range (analog value) and vice versa.

0 ... 10V

Meas. range (funct. no.)	Voltage (U)	Decimal (D)	Hex	Range	Formulas
0 ... 10V Siemens S7 format (10h)	11.76V	32511	7EFFh	overrange	$D = 27648 \cdot \frac{U}{10}$ $U = D \cdot \frac{10}{27648}$
	10V	27648	6C00h	nominal range	
	5V	13824	3600h		
	0V	0	0000h		
	-1.76V	-4864	ED00h	underrange	
0 ... 10V Siemens S5 format (20h)	12.5V	20480	5000h	overrange	$D = 16384 \cdot \frac{U}{10}$ $U = D \cdot \frac{10}{16384}$
	10V	16384	4000h	nominal range	
	5V	8192	2000h		
	0V	0	0000h		
	-2V	-3277	F333h	underrange	

3.21.3 Diagnostic data

So this module does not support diagnostic interrupt functions, the diagnostics data serve for information about this module. On error the corresponding channel LED of the module is activated and the error is registered in the diagnostics data.

The following errors are listed in the diagnostics data:

- Error in project engineering / parameterization
- Measuring range overflow
- Measuring range underflow
- Power supply failed

DS - Record set for access via CPU, PROFIBUS and PROFINET. The access happens by DS 01h. Additionally the first 4 bytes may be accessed by DS 00h.

IX - Index for access via CANopen. The access happens by IX 2F01h. Additionally the first 4 bytes may be accessed by IX 2F00h.

SX - Subindex for access via EtherCAT with Index 5005h.

More can be found in the according manual of your bus coupler.

Name	Bytes	Function	Default	DS	IX	SX
ERR_A	1	Diagnostic	00h	01h	2F01h	02h
MODTYP	1	Module information	15h			03h
ERR_C	1	reserved	00h			04h
ERR_D	1	Diagnostic	00h			05h
CHTYP	1	Channel type	71h			06h
NUMBIT	1	Number diagnostic bits per channel	08h			07h
NUMCH	1	Number of channels of a module	04h			08h

031-1CD35 - AI 4x16Bit 0...10V > Diagnostic data

Name	Bytes	Function	Default	DS	IX	SX
CHERR	1	Channel error	00h			09h
CH0ERR	1	Channel-specific error channel 0	00h			0Ah
CH1ERR	1	Channel-specific error channel 1	00h			0Bh
CH2ERR	1	Channel-specific error channel 2	00h			0Ch
CH3ERR	1	Channel-specific error channel 3	00h			0Dh
CH4ERR...CH7ERR	4	reserved	00h			0Eh ... 11h
DIAG_US	4	µs ticker	00h			13h

ERR_A Diagnostic

Byte	Bit 7 ... 0
0	<ul style="list-style-type: none"> ■ Bit 0: set at module failure ■ Bit 1: set at internal error ■ Bit 2: set at external error ■ Bit 3: set at channel error ■ Bit 4: set at external auxiliary supply missing ■ Bit 6 ... 5: reserved ■ Bit 7: set at error in parameterization

MODTYP Module information

Byte	Bit 7 ... 0
0	<ul style="list-style-type: none"> ■ Bit 3 ... 0: module class <ul style="list-style-type: none"> – 0101b analog module ■ Bit 4: set at channel information present ■ Bit 7 ... 5: reserved

CHTYP Channel type

Byte	Bit 7 ... 0
0	<ul style="list-style-type: none"> ■ Bit 6 ... 0: Channel type <ul style="list-style-type: none"> – 70h: Digital input – 71h: Analog input – 72h: Digital output – 73h: Analog output – 74h: Analog input/output – 76h: Counter ■ Bit 7: reserved

NUMBIT Diagnostic bits

Byte	Bit 7 ... 0
0	Number of diagnostic bits per channel (here 08h)

NUMCH Channels

Byte	Bit 7 ... 0
0	Number of channels of a module (here 04h)

CHERR Channel error

Byte	Bit 7 ... 0
0	<ul style="list-style-type: none"> ■ Bit 0: set at error in channel group 0 ■ Bit 1: set at error in channel group 1 ■ Bit 2: set at error in channel group 2 ■ Bit 3: set at error in channel group 3 ■ Bit 7 ... 4: reserved

**CH0ERR ... CH3ERR
Channel-specific**

Byte	Bit 7 ... 0
0	Channel-specific error channel x: <ul style="list-style-type: none"> ■ Bit 0: set at configuring/parameter assignment error ■ Bit 5 ... 1: reserved ■ Bit 6: set at measuring range underflow ■ Bit 7: set at measuring range overflow

**CH4ERR ... CH7ERR
reserved**

Byte	Bit 7 ... 0
0	reserved

DIAG_US μ s ticker

Byte	Bit 7 ... 0
0...3	Value of the μ s ticker at the moment of the diagnostic

 μ s ticker

In the System SLIO module there is a timer (μ s ticker). With PowerON the timer starts counting with 0. After $2^{32}-1\mu$ s the timer starts with 0 again.

3.22 031-1CD40 - AI 4x16Bit 0(4)...20mA

Properties

The electronic module has 4 inputs with parameterizable functions. The channels of the module are electrically isolated from the backplane bus. In addition, the channels are isolated to the DC 24V power supply by means of DC/DC converter.

- 4 analog inputs
- Suited for sensors with 0 ... 20mA;
4 ... 20mA with external supply
- Interrupt and diagnostics function
- Interference frequency suppression parameterizable (50/60Hz)
- 16bit resolution
- ↗ *Chap. 3.23 '031-1CD45 - AI 4x16Bit 0(4)...20mA' page 263*
with limited parameter set

Structure

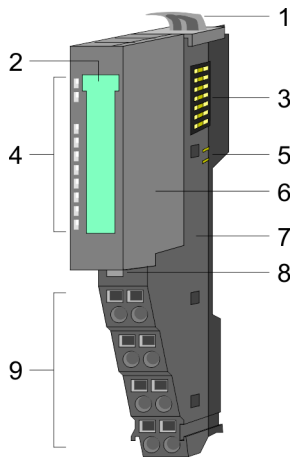

- 1 Locking lever terminal module
- 2 Labeling strip
- 3 Backplane bus
- 4 LED status indication
- 5 DC 24V power section supply
- 6 Electronic module
- 7 Terminal module
- 8 Locking lever electronic module
- 9 Terminal

Status indication

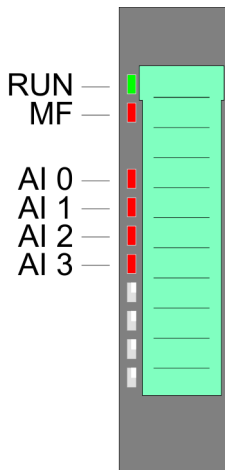

RUN	MF	AI x	Description
■ green	■ red	■ red	
■	<input type="checkbox"/>	X	Bus communication is OK Module status is OK
■	■	X	Bus communication is OK Module status reports an error
<input type="checkbox"/>	■	X	Bus communication is not possible Module status reports an error
<input type="checkbox"/>	<input type="checkbox"/>	X	Error at bus power supply
X	▣ 2Hz	X	Error in configuration ↗ <i>Chap. 2.8 'Trouble shooting - LEDs' page 30</i>
■	<input type="checkbox"/>	■	Error channel x <ul style="list-style-type: none"> ■ Signal leaves measuring range ■ Error in parameterization
not relevant: X			

Pin assignment

For wires with a cross section of 0.08mm² up to 1.5mm².

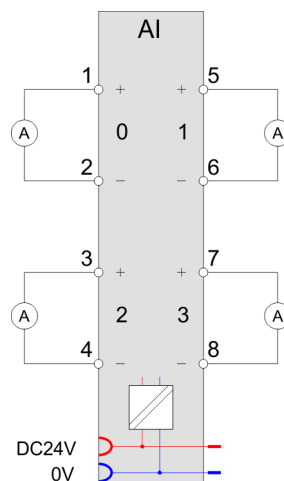
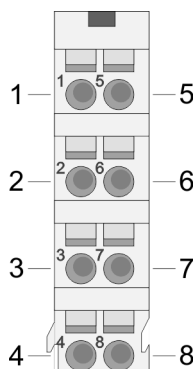

Pos.	Function	Type	Description
1	+AI 0	I	+ Channel 0
2	-AI 0	I	Ground Channel 0
3	+AI 2	I	+ Channel 2
4	-AI 2	I	Ground Channel 2
5	+AI 1	I	+ Channel 1
6	-AI 1	I	Ground Channel 1
7	+AI 3	I	+ Channel 3
8	-AI 3	I	Ground Channel 3

I: Input



If a 2wire measuring transducer is used, you have to connect in line an external power supply.

In-/Output area

At CPU, PROFIBUS and PROFINET the input respectively output area is embedded to the corresponding address area.

IX - Index for access via CANopen with s = Subindex, depends on number and type of analog modules

SX - Subindex for access via EtherCAT with Index 6000h + EtherCAT-Slot

More can be found in the according manual of your bus coupler.

Input area

Addr.	Name	Bytes	Function	IX	SX
+0	AI 0	2	Analog value channel 0	6401h/s	01h
+2	AI 1	2	Analog value channel 1	6401h/s+1	02h

031-1CD40 - AI 4x16Bit 0(4)...20mA > Technical data

Addr.	Name	Bytes	Function	IX	SX
+4	AI 2	2	Analog value channel 2	6401h/s+2	03h
+6	AI 3	2	Analog value channel 3	6401h/s+3	04h

Output area

No byte of the output area is used by the module.

3.22.1 Technical data

Order no.	031-1CD40
Type	SM 031
Module ID	0412 1544
Current consumption/power loss	
Current consumption from backplane bus	65 mA
Power loss	0.8 W
Technical data analog inputs	
Number of inputs	4
Cable length, shielded	200 m
Rated load voltage	DC 24 V
Current consumption from load voltage L+ (without load)	20 mA
Voltage inputs	-
Min. input resistance (voltage range)	-
Input voltage ranges	-
Operational limit of voltage ranges	-
Operational limit of voltage ranges with SFU	-
Basic error limit voltage ranges	-
Basic error limit voltage ranges with SFU	-
Destruction limit voltage	-
Current inputs	✓
Max. input resistance (current range)	60 Ω
Input current ranges	0 mA ... +20 mA +4 mA ... +20 mA
Operational limit of current ranges	+/-0.2%
Operational limit of current ranges with SFU	-
Basic error limit current ranges	+/-0.1%
Radical error limit current ranges with SFU	-
Destruction limit current inputs (voltage)	max. 24V
Destruction limit current inputs (electrical current)	max. 40mA

Order no.	031-1CD40
Resistance inputs	-
Resistance ranges	-
Operational limit of resistor ranges	-
Operational limit of resistor ranges with SFU	-
Basic error limit	-
Basic error limit with SFU	-
Destruction limit resistance inputs	-
Resistance thermometer inputs	-
Resistance thermometer ranges	-
Operational limit of resistance thermometer ranges	-
Operational limit of resistance thermometer ranges with SFU	-
Basic error limit thermoresistor ranges	-
Basic error limit thermoresistor ranges with SFU	-
Destruction limit resistance thermometer inputs	-
Thermocouple inputs	-
Thermocouple ranges	-
Operational limit of thermocouple ranges	-
Operational limit of thermocouple ranges with SFU	-
Basic error limit thermoelement ranges	-
Basic error limit thermoelement ranges with SFU	-
Destruction limit thermocouple inputs	-
Programmable temperature compensation	-
External temperature compensation	-
Internal temperature compensation	-
Temperature error internal compensation	-
Technical unit of temperature measurement	-
Resolution in bit	16
Measurement principle	successive approximation
Basic conversion time	240 µs all channels
Noise suppression for frequency	>80dB (UCM<4V)
Status information, alarms, diagnostics	
Status display	yes
Interrupts	yes, parameterizable
Process alarm	yes, parameterizable
Diagnostic interrupt	yes, parameterizable

031-1CD40 - AI 4x16Bit 0(4)...20mA > Technical data

Order no.	031-1CD40
Diagnostic functions	yes
Diagnostics information read-out	possible
Module state	green LED
Module error display	red LED
Channel error display	red LED per channel
Isolation	
Between channels	-
Between channels of groups to	-
Between channels and backplane bus	✓
Between channels and power supply	✓
Max. potential difference between circuits	-
Max. potential difference between inputs (Ucm)	DC 4 V
Max. potential difference between Mana and Mintern (Uiso)	-
Max. potential difference between inputs and Mana (Ucm)	-
Max. potential difference between inputs and Mintern (Uiso)	DC 75 V/ AC 50 V
Max. potential difference between Mintern and outputs	-
Insulation tested with	DC 500 V
Datasizes	
Input bytes	8
Output bytes	0
Parameter bytes	32
Diagnostic bytes	20
Housing	
Material	PPE / PPE GF10
Mounting	Profile rail 35 mm
Mechanical data	
Dimensions (WxHxD)	12.9 mm x 109 mm x 76.5 mm
Net weight	60 g
Weight including accessories	60 g
Gross weight	74 g
Environmental conditions	
Operating temperature	0 °C to 60 °C
Storage temperature	-25 °C to 70 °C
Certifications	

Order no.	031-1CD40
UL certification	yes
KC certification	yes

SFU - Interference frequency suppression

3.22.2 Parameter data

DS - Record set for access via CPU, PROFIBUS and PROFINET

IX - Index for access via CANopen

SX - Subindex for access via EtherCAT with Index 3100h + EtherCAT-Slot

More can be found in the according manual of your bus coupler.

Name	Bytes	Function	Default	DS	IX	SX
DIAG_EN	1	Diagnostics*	00h	00h	3100h	01h
RES1	1	reserved*	00h	00h	3101h	02h
LIMIT_EN	1	Limit value monitoring*	00h	00h	3102h	03h
SUPR	1	Interference frequency suppression (SFU)	00h	01h	3103h	04h
CH0FN	1	Function number channel 0	31h	80h	3104h	05h
RES7	1	reserved	00h	80h	3105h	06h
CH0UL	2	Upper limit value channel 0	7FFFh	80h	3106h...3107h	07h
CH0LL	2	Lower limit value channel 0	8000h	80h	3108h...3109h	08h
CH1FN	1	Function number channel 1	31h	81h	310Ah	09h
RES13	1	reserved	00h	81h	310Bh	0Ah
CH1UL	2	Upper limit value channel 1	7FFFh	81h	310Ch...310Dh	0Bh
CH1LL	2	Lower limit value channel 1	8000h	81h	310Eh...310Fh	0Ch
CH2FN	1	Function number channel 2	31h	82h	3110h	0Dh
RES19	1	reserved	00h	82h	3111h	0Eh
CH2UL	2	Upper limit value channel 2	7FFFh	82h	3112h...3113h	0Fh
CH2LL	2	Lower limit value channel 2	8000h	82h	3114h...3115h	10h
CH3FN	1	Function number channel 3	31h	83h	3116h	11h
RES25	1	reserved	00h	83h	3117h	12h
CH3UL	2	Upper limit value channel 3	7FFFh	83h	3118h...3119h	13h
CH3LL	2	Lower limit value channel 3	8000h	83h	311Ah...311Bh	14h

* This record set may only be transferred at STOP state.

DIAG_EN Diagnostic interrupt

Byte	Bit 7 ... 0
0	<ul style="list-style-type: none"> ■ Diagnostic interrupt <ul style="list-style-type: none"> – 00h: disabled – 40h: enabled

- Here you can enable respectively disable the diagnostic interrupt.

LIMIT_EN Limit value monitoring

Byte	Bit 7 ... 0
0	<ul style="list-style-type: none"> ■ Bit 0: Limit value monitoring channel 0 (1: on) ■ Bit 1: Limit value monitoring channel 1 (1: on) ■ Bit 2: Limit value monitoring channel 2 (1: on) ■ Bit 3: Limit value monitoring channel 3 (1: on) ■ Bit 7 ... 4: reserved

SUPR Interference frequency suppression (SFU)

Byte	Bit 7 ... 0
0	<ul style="list-style-type: none"> ■ Bit 1, 0: Interference frequency suppression channel 0 ■ Bit 3, 2: Interference frequency suppression channel 1 ■ Bit 5, 4: Interference frequency suppression channel 2 ■ Bit 7, 6: Interference frequency suppression channel 3 <ul style="list-style-type: none"> – 00: deactivated – 01: 60Hz – 10: 50Hz <p>e.g.: 10101010: all channels frequency suppression 50Hz</p>

CHxFN Function number channel x

In the following there are the measuring ranges with corresponding function number listed, which were supported by the analog module. With FFh the corresponding channel is deactivated. The formulas listed here allow you to transform an evaluated measuring value (digital value) to a value assigned to the measuring range (analog value) and vice versa.

0(4) ... 20mA

Meas. range (funct. no.)	Current (I)	Decimal (D)	Hex	Range	Formulas
0 ... 20mA Siemens S7 format (31h)	23.52mA	32511	7EFFh	overrange	$D = 27648 \cdot \frac{I}{20}$ $I = D \cdot \frac{20}{27648}$
	20mA	27648	6C00h	nominal range	
	10mA	13824	3600h		
	0mA	0	0000h		
	-3.52mA	-4864	ED00h	underrange	
0 ... 20mA Siemens S5 format (41h)	25.00mA	20480	5000h	overrange	$D = 16384 \cdot \frac{I}{20}$ $I = D \cdot \frac{20}{16384}$
	20mA	16384	4000h	nominal range	
	10mA	8192	2000h		
	0mA	0	0000h		
	-4,00mA	-3277	F333h	underrange	
4 ... 20mA Siemens S7 format (30h)	22.81mA	32511	7EFFh	overrange	$D = 27648 \cdot \frac{I-4}{16}$ $I = D \cdot \frac{16}{27648} + 4$
	20mA	27648	6C00h	nominal range	
	12mA	13824	3600h		
	4mA	0	0000h		
	1.19mA	-4864	ED00h	underrange	
4 ... 20mA Siemens S5 format (40h)	24.00mA	20480	5000h	overrange	$D = 16384 \cdot \frac{I-4}{16}$ $I = D \cdot \frac{16}{16384} + 4$
	20mA	16384	4000h	nominal range	
	12mA	8192	2000h		
	4mA	0	0000h		
	0.8mA	-3277	F333h	underrange	

**CHxUL CHxLL Upper limit
value Lower limit value
channel x**

For each channel an *upper* and a *lower limit* may be defined. Here only values of the nominal range may be preset, otherwise you receive a parameterization error. By presetting 7FFFh for the upper respectively 8000h for the lower limit value the corresponding limit is deactivated. As soon as the measuring value is beyond the limits and the limit value monitoring is activated, a process interrupt is initialized.

3.22.3 Diagnostics and interrupt

Event	Process interrupt	Diagnostics interrupt	parameterizable
Error in project engineering/ parameterization	-	X	-
Measuring range overflow	-	X	-
Measuring range underflow	-	X	-
Limit overflow	X	-	X
Limit underflow	X	-	X
Diagnostic buffer overflow	-	X	-
Communication error	-	X	-
Process interrupt lost	-	X	-

Process interrupt

So you may react to asynchronous events, there is the possibility to activate a process interrupt. A process interrupt interrupts the linear program sequence and jumps depending on the master system to a corresponding Interrupt routine. Here you can react to the process interrupt accordingly.

With CANopen the process interrupt data is transferred via an emergency telegram.

Operating with CPU, PROFIBUS and PROFINET the process interrupt data were transferred via diagnostics telegram.

SX - Subindex for access via EtherCAT with Index 5000h

More can be found in the according manual of your bus coupler.

Name	Bytes	Function	Default	SX
PRIT_OL	1	Upper limit overflow channel x	00h	02h
PRIT_UL	1	Lower limit underflow channel x	00h	03h
PRIT_US	2	µs-Ticker	00h	04h (high byte) 05h (low byte)

PRIT_OL Limit overflow

Byte	Bit 7 ... 0
0	<ul style="list-style-type: none"> ■ Bit 0: Limit overflow channel 0 ■ Bit 1: Limit overflow channel 1 ■ Bit 2: Limit overflow channel 2 ■ Bit 3: Limit overflow channel 3 ■ Bit 7 ... 4: reserved

PRIT_UL Limit underflow

Byte	Bit 7 ... 0
0	<ul style="list-style-type: none"> ■ Bit 0: Limit underflow channel 0 ■ Bit 1: Limit underflow channel 1 ■ Bit 2: Limit underflow channel 2 ■ Bit 3: Limit underflow channel 3 ■ Bit 7 ... 4: reserved

PRIT_US μ s ticker

Byte	Bit 7 ... 0
0 ... 1	Value of the μ s ticker at the moment of the diagnostic.

μ s ticker

In the SLIO module there is a 32 bit timer (μ s ticker). With PowerON the timer starts counting with 0. After $2^{32}-1\mu$ s the timer starts with 0 again. PRIT_US represents the lower 2 byte of the μ s ticker value ($0 \dots 2^{16}-1$).

Diagnostic data

Via the parameterization you may activate a diagnostic interrupt for the module. With a diagnostics interrupt the module serves for diagnostics data for diagnostic interrupt_{incoming}. As soon as the reason for releasing a diagnostic interrupt is no longer present, the diagnostic interrupt_{going} automatically takes place. All events of a channel between diagnostic interrupt_{incoming} and diagnostic interrupt_{going} are not stored and get lost. Within this time window (1. diagnostic interrupt_{incoming} until last diagnostic interrupt_{going}) the MF-LED of the module is on.

The following errors are listed in the diagnostics data:

- Error in project engineering / parameterization
- Measuring range overflow
- Measuring range underflow
- Process interrupt lost
- Power supply failed

DS - Record set for access via CPU, PROFIBUS and PROFINET. The access happens by DS 01h. Additionally the first 4 bytes may be accessed by DS 00h.

IX - Index for access via CANopen. The access happens by IX 2F01h. Additionally the first 4 bytes may be accessed by IX 2F00h.

SX - Subindex for access via EtherCAT with Index 5005h.

More can be found in the according manual of your bus coupler.

Name	Bytes	Function	Default	DS	IX	SX
ERR_A	1	Diagnostic	00h	01h	2F01h	02h
MODTYP	1	Module information	15h			03h
ERR_C	1	reserved	00h			04h
ERR_D	1	Diagnostic	00h			05h
CHTYP	1	Channel type	71h			06h
NUMBIT	1	Number diagnostic bits per channel	08h			07h

Name	Bytes	Function	Default	DS	IX	SX
NUMCH	1	Number of channels of a module	04h			08h
CHERR	1	Channel error	00h			09h
CH0ERR	1	Channel-specific error channel 0	00h			0Ah
CH1ERR	1	Channel-specific error channel 1	00h			0Bh
CH2ERR	1	Channel-specific error channel 2	00h			0Ch
CH3ERR	1	Channel-specific error channel 3	00h			0Dh
CH4ERR...CH7ERR	4	reserved	00h			0Eh ... 11h
DIAG_US	4	µs ticker	00h			13h

ERR_A Diagnostic

Byte	Bit 7 ... 0
0	<ul style="list-style-type: none"> ■ Bit 0: set at module failure ■ Bit 1: set at internal error ■ Bit 2: set at external error ■ Bit 3: set at channel error ■ Bit 4: set at external auxiliary supply missing ■ Bit 6 ... 5: reserved ■ Bit 7: set at error in parameterization

MODTYP Module information

Byte	Bit 7 ... 0
0	<ul style="list-style-type: none"> ■ Bit 3 ... 0: module class <ul style="list-style-type: none"> – 0101b analog module ■ Bit 4: set at channel information present ■ Bit 7 ... 5: reserved

ERR_D Diagnostic

Byte	Bit 7 ... 0
0	<ul style="list-style-type: none"> ■ Bit 2 ... 0: reserved ■ Bit 3: set at internal diagnostics buffer overflow ■ Bit 4: set at internal communication error ■ Bit 5: reserved ■ Bit 6: set at process interrupt lost ■ Bit 7: reserved

CHTYP Channel type

Byte	Bit 7 ... 0
0	<ul style="list-style-type: none"> ■ Bit 6 ... 0: Channel type <ul style="list-style-type: none"> – 70h: Digital input – 71h: Analog input – 72h: Digital output – 73h: Analog output – 74h: Analog input/-output – 76h: Counter ■ Bit 7: reserved

031-1CD40 - AI 4x16Bit 0(4)...20mA > Diagnostics and interrupt

NUMBIT Diagnostic bits

Byte	Bit 7 ... 0
0	Number of diagnostic bits per channel (here 08h)

NUMCH Channels

Byte	Bit 7 ... 0
0	Number of channels of a module (here 04h)

CHERR Channel error

Byte	Bit 7 ... 0
0	<ul style="list-style-type: none"> ■ Bit 0: set at error in channel group 0 ■ Bit 1: set at error in channel group 1 ■ Bit 2: set at error in channel group 2 ■ Bit 3: set at error in channel group 3 ■ Bit 7 ... 4: reserved

**CH0ERR ... CH3ERR
Channel-specific**

Byte	Bit 7 ... 0
0	Channel-specific error channel x: <ul style="list-style-type: none"> ■ Bit 0: set at configuring/parameter assignment error ■ Bit 4 ... 1: reserved ■ Bit 5: set at process interrupt lost ■ Bit 6: set at measuring range underflow ■ Bit 7: set at measuring range overflow

**CH4ERR ... CH7ERR
reserved**

Byte	Bit 7 ... 0
0	reserved

DIAG_US μ s ticker

Byte	Bit 7 ... 0
0...3	Value of the μ s ticker at the moment of the diagnostic

 μ s ticker

In the System SLIO module there is a timer (μ s ticker). With PowerON the timer starts counting with 0. After $2^{32}-1\mu$ s the timer starts with 0 again.

3.23 031-1CD45 - AI 4x16Bit 0(4)...20mA

Properties

The electronic module has 4 inputs with parameterizable functions. The channels of the module are electrically isolated from the backplane bus. In addition, the channels are isolated to the DC 24V power supply by means of DC/DC converter.

- 4 analog inputs
- Suited for sensors with 0 ... 20mA;
4 ... 20mA with external supply
- Diagnostics function
- Interference frequency suppression parameterizable (50/60Hz)
- 16bit resolution
- ↗ *Chap. 3.22 '031-1CD40 - AI 4x16Bit 0(4)...20mA' page 250* with extended parameter set

Structure

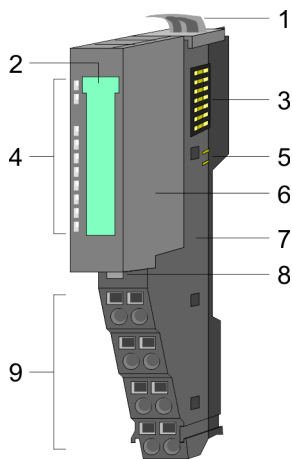

- 1 Locking lever terminal module
- 2 Labeling strip
- 3 Backplane bus
- 4 LED status indication
- 5 DC 24V power section supply
- 6 Electronic module
- 7 Terminal module
- 8 Locking lever electronic module
- 9 Terminal

Status indication

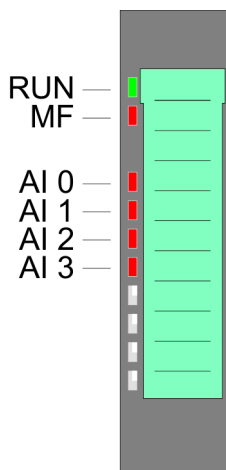

RUN	MF	AI x	Description
■ green	■ red	■ red	
■	<input type="checkbox"/>	X	Bus communication is OK Module status is OK
■	■	X	Bus communication is OK Module status reports an error
<input type="checkbox"/>	■	X	Bus communication is not possible Module status reports an error
<input type="checkbox"/>	<input type="checkbox"/>	X	Error at bus power supply
X	▣ 2Hz	X	Error in configuration ↗ <i>Chap. 2.8 'Trouble shooting - LEDs' page 30</i>
■	<input type="checkbox"/>	■	Error channel x <ul style="list-style-type: none"> ■ Signal leaves measuring range ■ Error in parameterization
not relevant: X			

031-1CD45 - AI 4x16Bit 0(4)...20mA

Pin assignment

For wires with a cross section of 0.08mm² up to 1.5mm².

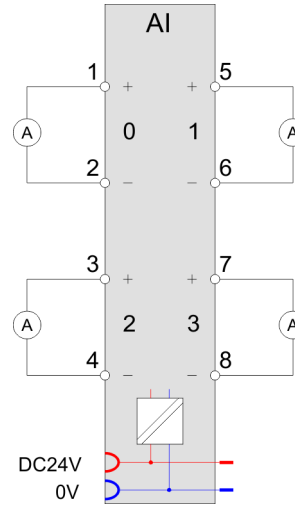
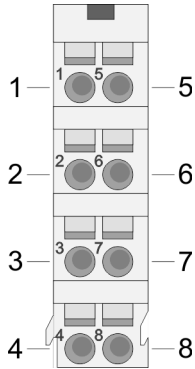

Pos.	Function	Type	Description
1	+AI 0	I	+ Channel 0
2	-AI 0	I	Ground Channel 0
3	+AI 2	I	+ Channel 2
4	-AI 2	I	Ground Channel 2
5	+AI 1	I	+ Channel 1
6	-AI 1	I	Ground Channel 1
7	+AI 3	I	+ Channel 3
8	-AI 3	I	Ground Channel 3

I: Input



If a 2wire measuring transducer is used, you have to connect in line an external power supply.

In-/Output area

At CPU, PROFIBUS and PROFINET the input respectively output area is embedded to the corresponding address area.

IX - Index for access via CANopen with s = Subindex, depends on number and type of analog modules

SX - Subindex for access via EtherCAT with Index 6000h + EtherCAT-Slot

More can be found in the according manual of your bus coupler.

Input area

Addr.	Name	Bytes	Function	IX	SX
+0	AI 0	2	Analog value channel 0	6401h/s	01h
+2	AI 1	2	Analog value channel 1	6401h/s+1	02h

Addr.	Name	Bytes	Function	IX	SX
+4	AI 2	2	Analog value channel 2	6401h/s+2	03h
+6	AI 3	2	Analog value channel 3	6401h/s+3	04h

Output area

No byte of the output area is used by the module.

3.23.1 Technical data

Order no.	031-1CD45
Type	SM 031
Module ID	0414 15C4
Current consumption/power loss	
Current consumption from backplane bus	65 mA
Power loss	0.8 W
Technical data analog inputs	
Number of inputs	4
Cable length, shielded	200 m
Rated load voltage	DC 24 V
Current consumption from load voltage L+ (without load)	20 mA
Voltage inputs	-
Min. input resistance (voltage range)	-
Input voltage ranges	-
Operational limit of voltage ranges	-
Operational limit of voltage ranges with SFU	-
Basic error limit voltage ranges	-
Basic error limit voltage ranges with SFU	-
Destruction limit voltage	-
Current inputs	✓
Max. input resistance (current range)	60 Ω
Input current ranges	0 mA ... +20 mA +4 mA ... +20 mA
Operational limit of current ranges	+/-0.2%
Operational limit of current ranges with SFU	-
Basic error limit current ranges	+/-0.1%
Radical error limit current ranges with SFU	-
Destruction limit current inputs (voltage)	max. 24V
Destruction limit current inputs (electrical current)	max. 40mA

031-1CD45 - AI 4x16Bit 0(4)...20mA > Technical data

Order no.	031-1CD45
Resistance inputs	-
Resistance ranges	-
Operational limit of resistor ranges	-
Operational limit of resistor ranges with SFU	-
Basic error limit	-
Basic error limit with SFU	-
Destruction limit resistance inputs	-
Resistance thermometer inputs	-
Resistance thermometer ranges	-
Operational limit of resistance thermometer ranges	-
Operational limit of resistance thermometer ranges with SFU	-
Basic error limit thermoresistor ranges	-
Basic error limit thermoresistor ranges with SFU	-
Destruction limit resistance thermometer inputs	-
Thermocouple inputs	-
Thermocouple ranges	-
Operational limit of thermocouple ranges	-
Operational limit of thermocouple ranges with SFU	-
Basic error limit thermoelement ranges	-
Basic error limit thermoelement ranges with SFU	-
Destruction limit thermocouple inputs	-
Programmable temperature compensation	-
External temperature compensation	-
Internal temperature compensation	-
Temperature error internal compensation	-
Technical unit of temperature measurement	-
Resolution in bit	16
Measurement principle	successive approximation
Basic conversion time	240 µs all channels
Noise suppression for frequency	>80dB (UCM<4V)
Status information, alarms, diagnostics	
Status display	yes
Interrupts	no
Process alarm	no
Diagnostic interrupt	no

Order no.	031-1CD45
Diagnostic functions	yes
Diagnostics information read-out	possible
Module state	green LED
Module error display	red LED
Channel error display	red LED per channel
Isolation	
Between channels	-
Between channels of groups to	-
Between channels and backplane bus	✓
Between channels and power supply	✓
Max. potential difference between circuits	-
Max. potential difference between inputs (Ucm)	DC 4 V
Max. potential difference between Mana and Mintern (Uiso)	-
Max. potential difference between inputs and Mana (Ucm)	-
Max. potential difference between inputs and Mintern (Uiso)	DC 75 V/ AC 50 V
Max. potential difference between Mintern and outputs	-
Insulation tested with	DC 500 V
Technical data encoder supply	
Number of outputs	-
Output voltage (typ)	-
Output voltage (rated value)	-
Short-circuit protection	-
Binding of potential	-
Datasizes	
Input bytes	8
Output bytes	0
Parameter bytes	9
Diagnostic bytes	20
Housing	
Material	PPE / PPE GF10
Mounting	Profile rail 35 mm
Mechanical data	
Dimensions (WxHxD)	12.9 mm x 109 mm x 76.5 mm
Net weight	60 g
Weight including accessories	60 g

031-1CD45 - AI 4x16Bit 0(4)...20mA > Parameter data

Order no.	031-1CD45
Gross weight	75 g
Environmental conditions	
Operating temperature	0 °C to 60 °C
Storage temperature	-25 °C to 70 °C
Certifications	
UL certification	yes
KC certification	yes

SFU - Interference frequency suppression

3.23.2 Parameter data

DS - Record set for access via CPU, PROFIBUS and PROFINET

IX - Index for access via CANopen

SX - Subindex for access via EtherCAT with Index 3100h + EtherCAT-Slot

More can be found in the according manual of your bus coupler.

Name	Bytes	Function	Default	DS	IX	SX
SUPR	1	Interference frequency suppression (SFU)	00h	01h	3100h	01h
CH0FN	1	Function number channel 0	31h	80h	3101h	02h
CH1FN	1	Function number channel 1	31h	81h	3102h	03h
CH2FN	1	Function number channel 2	31h	82h	3103h	04h
CH3FN	1	Function number channel 3	31h	83h	3104h	05h

SUPR Interference frequency suppression (SFU)

Byte	Bit 7 ... 0
0	<ul style="list-style-type: none"> ■ Bit 1, 0: Interference frequency suppression channel 0 ■ Bit 3, 2: Interference frequency suppression channel 1 ■ Bit 5, 4: Interference frequency suppression channel 2 ■ Bit 7, 6: Interference frequency suppression channel 3 – 00: deactivated – 01: 60Hz – 10: 50Hz <p>e.g.: 10101010: all channels frequency suppression 50Hz</p>

CHxFN Function number channel x

In the following there are the measuring ranges with corresponding function number listed, which were supported by the analog module. With FFh the corresponding channel is deactivated. The formulas listed here allow you to transform an evaluated measuring value (digital value) to a value assigned to the measuring range (analog value) and vice versa.

0(4) ... 20mA

Meas. range (funct. no.)	Current (I)	Decimal (D)	Hex	Range	Formulas
0 ... 20mA Siemens S7 format (31h)	23.52mA	32511	7EFFh	overrange	$D = 27648 \cdot \frac{I}{20}$ $I = D \cdot \frac{20}{27648}$
	20mA	27648	6C00h	nominal range	
	10mA	13824	3600h		
	0mA	0	0000h		
	-3.52mA	-4864	ED00h	underrange	
0 ... 20mA Siemens S5 format (41h)	25.00mA	20480	5000h	overrange	$D = 16384 \cdot \frac{I}{20}$ $I = D \cdot \frac{20}{16384}$
	20mA	16384	4000h	nominal range	
	10mA	8192	2000h		
	0mA	0	0000h		
	-4,00mA	-3277	F333h	underrange	
4 ... 20mA Siemens S7 format (30h)	22.81mA	32511	7EFFh	overrange	$D = 27648 \cdot \frac{I-4}{16}$ $I = D \cdot \frac{16}{27648} + 4$
	20mA	27648	6C00h	nominal range	
	12mA	13824	3600h		
	4mA	0	0000h		
	1.19mA	-4864	ED00h	underrange	
4 ... 20mA Siemens S5 format (40h)	24.00mA	20480	5000h	overrange	$D = 16384 \cdot \frac{I-4}{16}$ $I = D \cdot \frac{16}{16384} + 4$
	20mA	16384	4000h	nominal range	
	12mA	8192	2000h		
	4mA	0	0000h		
	0.8mA	-3277	F333h	underrange	

3.23.3 Diagnostic data

So this module does not support diagnostic interrupt functions, the diagnostics data serve for information about this module. On error the corresponding channel LED of the module is activated and the error is registered in the diagnostics data.

The following errors are listed in the diagnostics data:

- Error in project engineering / parameterization
- Measuring range overflow
- Measuring range underflow
- Power supply failed

DS - Record set for access via CPU, PROFIBUS and PROFINET. The access happens by DS 01h. Additionally the first 4 bytes may be accessed by DS 00h.

IX - Index for access via CANopen. The access happens by IX 2F01h. Additionally the first 4 bytes may be accessed by IX 2F00h.

SX - Subindex for access via EtherCAT with Index 5005h.

More can be found in the according manual of your bus coupler.

031-1CD45 - AI 4x16Bit 0(4)...20mA > Diagnostic data

Name	Bytes	Function	Default	DS	IX	SX
ERR_A	1	Diagnostic	00h	01h	2F01h	02h
MODTYP	1	Module information	15h			03h
ERR_C	1	reserved	00h			04h
ERR_D	1	Diagnostic	00h			05h
CHTYP	1	Channel type	71h			06h
NUMBIT	1	Number diagnostic bits per channel	08h			07h
NUMCH	1	Number of channels of a module	04h			08h
CHERR	1	Channel error	00h			09h
CH0ERR	1	Channel-specific error channel 0	00h			0Ah
CH1ERR	1	Channel-specific error channel 1	00h			0Bh
CH2ERR	1	Channel-specific error channel 2	00h			0Ch
CH3ERR	1	Channel-specific error channel 3	00h			0Dh
CH4ERR...CH7ERR	4	reserved	00h			0Eh ... 11h
DIAG_US	4	µs ticker	00h			13h

ERR_A Diagnostic

Byte	Bit 7 ... 0
0	<ul style="list-style-type: none"> ■ Bit 0: set at module failure ■ Bit 1: set at internal error ■ Bit 2: set at external error ■ Bit 3: set at channel error ■ Bit 4: set at external auxiliary supply missing ■ Bit 6 ... 5: reserved ■ Bit 7: set at error in parameterization

MODTYP Module information

Byte	Bit 7 ... 0
0	<ul style="list-style-type: none"> ■ Bit 3 ... 0: module class <ul style="list-style-type: none"> – 0101b analog module ■ Bit 4: set at channel information present ■ Bit 7 ... 5: reserved

ERR_D Diagnostic

Byte	Bit 7 ... 0
0	<ul style="list-style-type: none"> ■ Bit 2 ... 0: reserved ■ Bit 3: set at internal diagnostics buffer overflow ■ Bit 4: set at internal communication error ■ Bit 7 ... 5: reserved

CHTYP Channel type

Byte	Bit 7 ... 0
0	<ul style="list-style-type: none"> ■ Bit 6 ... 0: Channel type <ul style="list-style-type: none"> – 70h: Digital input – 71h: Analog input – 72h: Digital output – 73h: Analog output – 74h: Analog input/-output – 76h: Counter ■ Bit 7: reserved

NUMBIT Diagnostic bits

Byte	Bit 7 ... 0
0	Number of diagnostic bits per channel (here 08h)

NUMCH Channels

Byte	Bit 7 ... 0
0	Number of channels of a module (here 04h)

CHERR Channel error

Byte	Bit 7 ... 0
0	<ul style="list-style-type: none"> ■ Bit 0: set at error in channel group 0 ■ Bit 1: set at error in channel group 1 ■ Bit 2: set at error in channel group 2 ■ Bit 3: set at error in channel group 3 ■ Bit 7 ... 4: reserved

**CH0ERR ... CH3ERR
Channel-specific**

Byte	Bit 7 ... 0
0	Channel-specific error channel x: <ul style="list-style-type: none"> ■ Bit 0: set at configuring/parameter assignment error ■ Bit 5 ... 1: reserved ■ Bit 6: set at measuring range underflow ■ Bit 7: set at measuring range overflow

**CH4ERR ... CH7ERR
reserved**

Byte	Bit 7 ... 0
0	reserved

DIAG_US μ s ticker

Byte	Bit 7 ... 0
0...3	Value of the μ s ticker at the moment of the diagnostic

 μ s ticker

In the System SLIO module there is a timer (μ s ticker). With PowerON the timer starts counting with 0. After $2^{32}-1\mu$ s the timer starts with 0 again.

3.24 031-1CD70 - AI 4x16Bit ±10V

Properties

The electronic module has 4 inputs with parameterizable functions. The channels of the module are electrically isolated from the backplane bus. In addition, the channels are isolated to the DC 24V power supply by means of DC/DC converter.

- 4 analog inputs
- Suited for sensors with ±10V, 0 ... 10V
- Interrupt and diagnostics function
- Interference frequency suppression parameterizable (50/60Hz)
- 16bit resolution

Structure

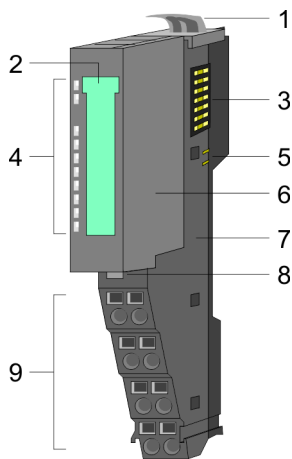

- 1 Locking lever terminal module
- 2 Labeling strip
- 3 Backplane bus
- 4 LED status indication
- 5 DC 24V power section supply
- 6 Electronic module
- 7 Terminal module
- 8 Locking lever electronic module
- 9 Terminal

Status indication

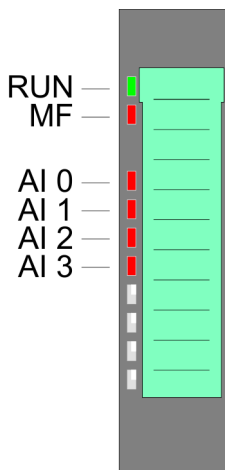

RUN	MF	AI x	Description
■ green	■ red	■ red	
■	<input type="checkbox"/>	X	Bus communication is OK Module status is OK
■	■	X	Bus communication is OK Module status reports an error
<input type="checkbox"/>	■	X	Bus communication is not possible Module status reports an error
<input type="checkbox"/>	<input type="checkbox"/>	X	Error at bus power supply
X	▣ 2Hz	X	Error in configuration Chap. 2.8 'Trouble shooting - LEDs' page 30
■	<input type="checkbox"/>	■	Error channel x <ul style="list-style-type: none"> ■ Signal leaves measuring range ■ Error in parameterization
not relevant: X			

Pin assignment

For wires with a cross section of 0.08mm² up to 1.5mm².

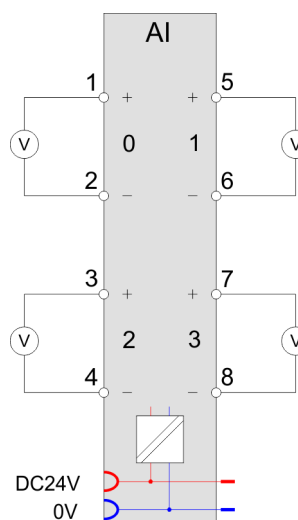
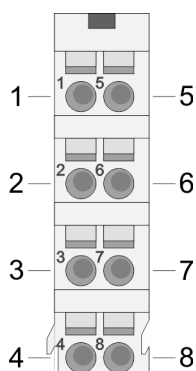

Pos.	Function	Type	Description
1	+AI 0	I	+ Channel 0
2	-AI 0	I	Ground Channel 0
3	+AI 2	I	+ Channel 2
4	-AI 2	I	Ground Channel 2
5	+AI 1	I	+ Channel 1
6	-AI 1	I	Ground Channel 1
7	+AI 3	I	+ Channel 3
8	-AI 3	I	Ground Channel 3

I: Input

In-/Output area

At CPU, PROFIBUS and PROFINET the input respectively output area is embedded to the corresponding address area.

IX - Index for access via CANopen with s = Subindex, depends on number and type of analog modules

SX - Subindex for access via EtherCAT with Index 6000h + EtherCAT-Slot

More can be found in the according manual of your bus coupler.

Input area

Addr.	Name	Bytes	Function	IX	SX
+0	AI 0	2	Analog value channel 0	6401h/s	01h
+2	AI 1	2	Analog value channel 1	6401h/s+1	02h
+4	AI 2	2	Analog value channel 2	6401h/s+2	03h
+6	AI 3	2	Analog value channel 3	6401h/s+3	04h

Output area

No byte of the output area is used by the module.

3.24.1 Technical data

Order no.	031-1CD70
Type	SM 031
Module ID	040E 1544
Current consumption/power loss	
Current consumption from backplane bus	65 mA
Power loss	0.9 W
Technical data analog inputs	
Number of inputs	4
Cable length, shielded	200 m
Rated load voltage	DC 24 V
Current consumption from load voltage L+ (without load)	25 mA
Voltage inputs	✓
Min. input resistance (voltage range)	200 k Ω
Input voltage ranges	-10 V ... +10 V 0 V ... +10 V
Operational limit of voltage ranges	+/-0.2%
Operational limit of voltage ranges with SFU	-
Basic error limit voltage ranges	+/-0.1%
Basic error limit voltage ranges with SFU	-
Destruction limit voltage	max. 30V
Current inputs	-
Max. input resistance (current range)	-
Input current ranges	-
Operational limit of current ranges	-
Operational limit of current ranges with SFU	-
Basic error limit current ranges	-
Radical error limit current ranges with SFU	-
Destruction limit current inputs (voltage)	-
Destruction limit current inputs (electrical current)	-
Resistance inputs	-
Resistance ranges	-
Operational limit of resistor ranges	-
Operational limit of resistor ranges with SFU	-
Basic error limit	-
Basic error limit with SFU	-
Destruction limit resistance inputs	-

Order no.	031-1CD70
Resistance thermometer inputs	-
Resistance thermometer ranges	-
Operational limit of resistance thermometer ranges	-
Operational limit of resistance thermometer ranges with SFU	-
Basic error limit thermoresistor ranges	-
Basic error limit thermoresistor ranges with SFU	-
Destruction limit resistance thermometer inputs	-
Thermocouple inputs	-
Thermocouple ranges	-
Operational limit of thermocouple ranges	-
Operational limit of thermocouple ranges with SFU	-
Basic error limit thermoelement ranges	-
Basic error limit thermoelement ranges with SFU	-
Destruction limit thermocouple inputs	-
Programmable temperature compensation	-
External temperature compensation	-
Internal temperature compensation	-
Temperature error internal compensation	-
Technical unit of temperature measurement	-
Resolution in bit	16
Measurement principle	successive approximation
Basic conversion time	480 μs all channels
Noise suppression for frequency	>80dB at 50Hz (UCM<35V)
Status information, alarms, diagnostics	
Status display	yes
Interrupts	yes, parameterizable
Process alarm	yes, parameterizable
Diagnostic interrupt	yes, parameterizable
Diagnostic functions	yes
Diagnostics information read-out	possible
Module state	green LED
Module error display	red LED
Channel error display	red LED per channel
Isolation	
Between channels	-

031-1CD70 - AI 4x16Bit $\pm 10V$ > Technical data

Order no.	031-1CD70
Between channels of groups to	-
Between channels and backplane bus	✓
Between channels and power supply	✓
Max. potential difference between circuits	-
Max. potential difference between inputs (Ucm)	DC 9 V
Max. potential difference between Mana and Mintern (Uiso)	-
Max. potential difference between inputs and Mana (Ucm)	-
Max. potential difference between inputs and Mintern (Uiso)	DC 75 V/ AC 50 V
Max. potential difference between Mintern and outputs	-
Insulation tested with	DC 500 V
Datasizes	
Input bytes	8
Output bytes	0
Parameter bytes	32
Diagnostic bytes	20
Housing	
Material	PPE / PPE GF10
Mounting	Profile rail 35 mm
Mechanical data	
Dimensions (WxHxD)	12.9 mm x 109 mm x 76.5 mm
Net weight	61 g
Weight including accessories	61 g
Gross weight	75 g
Environmental conditions	
Operating temperature	0 °C to 60 °C
Storage temperature	-25 °C to 70 °C
Certifications	
UL certification	yes
KC certification	yes

SFU - Interference frequency suppression

3.24.2 Parameter data

DS - Record set for access via CPU, PROFIBUS and PROFINET

IX - Index for access via CANopen

SX - Subindex for access via EtherCAT with Index 3100h + EtherCAT-Slot

More can be found in the according manual of your bus coupler.

Name	Bytes	Function	Default	DS	IX	SX
DIAG_EN	1	Diagnostics*	00h	00h	3100h	01h
RES1	1	reserved*	00h	00h	3101h	02h
LIMIT_EN	1	Limit value monitoring*	00h	00h	3102h	03h
SUPR	1	Interference frequency suppression (SFU)	00h	01h	3103h	04h
CH0FN	1	Function number channel 0	12h	80h	3104h	05h
RES7	1	reserved	00h	80h	3105h	06h
CH0UL	2	Upper limit value channel 0	7FFFh	80h	3106h...3107h	07h
CH0LL	2	Lower limit value channel 0	8000h	80h	3108h...3109h	08h
CH1FN	1	Function number channel 1	12h	81h	310Ah	09h
RES13	1	reserved	00h	81h	310Bh	0Ah
CH1UL	2	Upper limit value channel 1	7FFFh	81h	310Ch...310Dh	0Bh
CH1LL	2	Lower limit value channel 1	8000h	81h	310Eh...310Fh	0Ch
CH2FN	1	Function number channel 2	12h	82h	3110h	0Dh
RES19	1	reserved	00h	82h	3111h	0Eh
CH2UL	2	Upper limit value channel 2	7FFFh	82h	3112h...3113h	0Fh
CH2LL	2	Lower limit value channel 2	8000h	82h	3114h...3115h	10h
CH3FN	1	Function number channel 3	12h	83h	3116h	11h
RES25	1	reserved	00h	83h	3117h	12h
CH3UL	2	Upper limit value channel 3	7FFFh	83h	3118h...3119h	13h
CH3LL	2	Lower limit value channel 3	8000h	83h	311Ah...311Bh	14h

* This record set may only be transferred at STOP state.

DIAG_EN Diagnostic interrupt

Byte	Bit 7 ... 0
0	<ul style="list-style-type: none"> ■ Diagnostic interrupt <ul style="list-style-type: none"> – 00h: disabled – 40h: enabled

- Here you can enable respectively disable the diagnostic interrupt.

LIMIT_EN Limit value monitoring

Byte	Bit 7 ... 0
0	<ul style="list-style-type: none"> ■ Bit 0: Limit value monitoring channel 0 (1: on) ■ Bit 1: Limit value monitoring channel 1 (1: on) ■ Bit 2: Limit value monitoring channel 2 (1: on) ■ Bit 3: Limit value monitoring channel 3 (1: on) ■ Bit 7 ... 4: reserved

SUPR Interference frequency suppression (SFU)

Byte	Bit 7 ... 0
0	<ul style="list-style-type: none"> ■ Bit 1, 0: Interference frequency suppression channel 0 ■ Bit 3, 2: Interference frequency suppression channel 1 ■ Bit 5, 4: Interference frequency suppression channel 2 ■ Bit 7, 6: Interference frequency suppression channel 3 <ul style="list-style-type: none"> – 00: deactivated – 01: 60Hz – 10: 50Hz <p>e.g.: 10101010: all channels frequency suppression 50Hz</p>

CHxFN Function number channel x

In the following there are the measuring ranges with corresponding function number listed, which were supported by the analog module. With FFh the corresponding channel is deactivated. The formulas listed here allow you to transform an evaluated measuring value (digital value) to a value assigned to the measuring range (analog value) and vice versa.

±10V

Meas. range (funct. no.)	Voltage (U)	Decimal (D)	Hex	Range	Formulas
±10V Siemens S7 format (12h)	11.76V	32511	7EFFh	overrange	$D = 27648 \cdot \frac{U}{10}$ $U = D \cdot \frac{10}{27648}$
	10V	27648	6C00h	nominal range	
	5V	13824	3600h		
	0V	0	0000h		
	-5V	-13824	CA00h	underrange	
	-10V	-27648	9400h		
	-11.76V	-32512	8100h		
±10V Siemens S5 format (22h)	12.5V	20480	5000h	overrange	$D = 16384 \cdot \frac{U}{10}$ $U = D \cdot \frac{10}{16384}$
	10V	16384	4000h	nominal range	
	5V	8192	2000h		
	0V	0	0000h		
	-5V	-8192	E000h	underrange	
	-10V	-16384	C000h		
	-12.5V	-20480	B000h		

0 ... 10V

Meas. range (funct. no.)	Voltage (U)	Decimal (D)	Hex	Range	Formulas
0 ... 10V Siemens S7 format (10h)	11.76V	32511	7EFFh	overrange	$D = 27648 \cdot \frac{U}{10}$ $U = D \cdot \frac{10}{27648}$
	10V	27648	6C00h	nominal range	
	5V	13824	3600h		
	0V	0	0000h		
	-1.76V	-4864	ED00h	underrange	
0 ... 10V Siemens S5 format (20h)	12.5V	20480	5000h	overrange	$D = 16384 \cdot \frac{U}{10}$ $U = D \cdot \frac{10}{16384}$
	10V	16384	4000h	nominal range	
	5V	8192	2000h		
	0V	0	0000h		
	-2V	-3277	F333h	underrange	

CHxUL CHxLL Upper limit value Lower limit value channel x

For each channel an *upper* and a *lower limit* may be defined. Here only values of the nominal range may be preset, otherwise you receive a parameterization error. By presetting 7FFFh for the upper respectively 8000h for the lower limit value the corresponding limit is deactivated. As soon as the measuring value is beyond the limits and the limit value monitoring is activated, a process interrupt is initialized.

3.24.3 Diagnostics and interrupt

Event	Process interrupt	Diagnostics interrupt	parameterizable
Error in project engineering/ parameterization	-	X	-
Measuring range overflow	-	X	-
Measuring range underflow	-	X	-
Limit overflow	X	-	X
Limit underflow	X	-	X
Diagnostic buffer overflow	-	X	-
Communication error	-	X	-
Process interrupt lost	-	X	-

Process interrupt

So you may react to asynchronous events, there is the possibility to activate a process interrupt. A process interrupt interrupts the linear program sequence and jumps depending on the master system to a corresponding Interrupt routine. Here you can react to the process interrupt accordingly.

With CANopen the process interrupt data is transferred via an emergency telegram.

Operating with CPU, PROFIBUS and PROFINET the process interrupt data were transferred via diagnostics telegram.

SX - Subindex for access via EtherCAT with Index 5000h

More can be found in the according manual of your bus coupler.

Name	Bytes	Function	Default	SX
PRIT_OL	1	Upper limit overflow channel x	00h	02h
PRIT_UL	1	Lower limit underflow channel x	00h	03h
PRIT_US	2	µs-Ticker	00h	04h (high byte) 05h (low byte)

PRIT_OL Limit overflow

Byte	Bit 7 ... 0
0	<ul style="list-style-type: none"> ■ Bit 0: Limit overflow channel 0 ■ Bit 1: Limit overflow channel 1 ■ Bit 2: Limit overflow channel 2 ■ Bit 3: Limit overflow channel 3 ■ Bit 7 ... 4: reserved

PRIT_UL Limit underflow

Byte	Bit 7 ... 0
0	<ul style="list-style-type: none"> ■ Bit 0: Limit underflow channel 0 ■ Bit 1: Limit underflow channel 1 ■ Bit 2: Limit underflow channel 2 ■ Bit 3: Limit underflow channel 3 ■ Bit 7 ... 4: reserved

PRIT_US μ s ticker

Byte	Bit 7 ... 0
0 ... 1	Value of the μ s ticker at the moment of the diagnostic.

 μ s ticker

In the SLIO module there is a 32 bit timer (μ s ticker). With PowerON the timer starts counting with 0. After $2^{32}-1\mu$ s the timer starts with 0 again. PRIT_US represents the lower 2 byte of the μ s ticker value (0 ... $2^{16}-1$).

Diagnostic data

Via the parameterization you may activate a diagnostic interrupt for the module. With a diagnostics interrupt the module serves for diagnostics data for diagnostic interrupt_{incoming}. As soon as the reason for releasing a diagnostic interrupt is no longer present, the diagnostic interrupt_{going} automatically takes place. All events of a channel between diagnostic interrupt_{incoming} and diagnostic interrupt_{going} are not stored and get lost. Within this time window (1. diagnostic interrupt_{incoming} until last diagnostic interrupt_{going}) the MF-LED of the module is on.

The following errors are listed in the diagnostics data:

- Error in project engineering / parameterization
- Measuring range overflow
- Measuring range underflow
- Process interrupt lost
- Power supply failed

DS - Record set for access via CPU, PROFIBUS and PROFINET. The access happens by DS 01h. Additionally the first 4 bytes may be accessed by DS 00h.

IX - Index for access via CANopen. The access happens by IX 2F01h. Additionally the first 4 bytes may be accessed by IX 2F00h.

SX - Subindex for access via EtherCAT with Index 5005h.

More can be found in the according manual of your bus coupler.

Name	Bytes	Function	Default	DS	IX	SX
ERR_A	1	Diagnostic	00h	01h	2F01h	02h
MODTYP	1	Module information	15h			03h
ERR_C	1	reserved	00h			04h
ERR_D	1	Diagnostic	00h			05h
CHTYP	1	Channel type	71h			06h
NUMBIT	1	Number diagnostic bits per channel	08h			07h
NUMCH	1	Number of channels of a module	04h			08h
CHERR	1	Channel error	00h			09h
CH0ERR	1	Channel-specific error channel 0	00h			0Ah
CH1ERR	1	Channel-specific error channel 1	00h			0Bh
CH2ERR	1	Channel-specific error channel 2	00h			0Ch
CH3ERR	1	Channel-specific error channel 3	00h			0Dh

031-1CD70 - AI 4x16Bit ±10V > Diagnostics and interrupt

Name	Bytes	Function	Default	DS	IX	SX
CH4ERR...CH7ERR	4	reserved	00h			0Eh ... 11h
DIAG_US	4	µs ticker	00h			13h

ERR_A Diagnostic

Byte	Bit 7 ... 0
0	<ul style="list-style-type: none"> ■ Bit 0: set at module failure ■ Bit 1: set at internal error ■ Bit 2: set at external error ■ Bit 3: set at channel error ■ Bit 4: set at external auxiliary supply missing ■ Bit 6 ... 5: reserved ■ Bit 7: set at error in parameterization

MODTYP Module information

Byte	Bit 7 ... 0
0	<ul style="list-style-type: none"> ■ Bit 3 ... 0: module class <ul style="list-style-type: none"> – 0101b analog module ■ Bit 4: set at channel information present ■ Bit 7 ... 5: reserved

ERR_D Diagnostic

Byte	Bit 7 ... 0
0	<ul style="list-style-type: none"> ■ Bit 2 ... 0: reserved ■ Bit 3: set at internal diagnostics buffer overflow ■ Bit 4: set at internal communication error ■ Bit 5: reserved ■ Bit 6: set at process interrupt lost ■ Bit 7: reserved

CHTYP Channel type

Byte	Bit 7 ... 0
0	<ul style="list-style-type: none"> ■ Bit 6 ... 0: Channel type <ul style="list-style-type: none"> – 70h: Digital input – 71h: Analog input – 72h: Digital output – 73h: Analog output – 74h: Analog input/-output – 76h: Counter ■ Bit 7: reserved

NUMBIT Diagnostic bits

Byte	Bit 7 ... 0
0	Number of diagnostic bits per channel (here 08h)

NUMCH Channels

Byte	Bit 7 ... 0
0	Number of channels of a module (here 04h)

CHERR Channel error

Byte	Bit 7 ... 0
0	<ul style="list-style-type: none"> ■ Bit 0: set at error in channel group 0 ■ Bit 1: set at error in channel group 1 ■ Bit 2: set at error in channel group 2 ■ Bit 3: set at error in channel group 3 ■ Bit 7 ... 4: reserved

**CH0ERR ... CH3ERR
Channel-specific**

Byte	Bit 7 ... 0
0	Channel-specific error channel x: <ul style="list-style-type: none"> ■ Bit 0: set at configuring/parameter assignment error ■ Bit 4 ... 1: reserved ■ Bit 5: set at process interrupt lost ■ Bit 6: set at measuring range underflow ■ Bit 7: set at measuring range overflow

**CH4ERR ... CH7ERR
reserved**

Byte	Bit 7 ... 0
0	reserved

DIAG_US μ s ticker

Byte	Bit 7 ... 0
0...3	Value of the μ s ticker at the moment of the diagnostic

 μ s ticker

In the System SLIO module there is a timer (μ s ticker). With PowerON the timer starts counting with 0. After $2^{32}-1\mu$ s the timer starts with 0 again.

3.25 031-1LB90 - AI 2x16Bit TC

Properties

The electronic module has 2 inputs for temperature and voltage measuring with parameterizable functions. The channels of the module are isolated to the backplane bus.

- 2 analog inputs
- Suited for sensors with type J, K, N, R, S, T, B, C, E, L and for voltage measuring ± 80mV
- Diagnostics function
- 16bit resolution
- Internal temperature compensation
- High potential gradient of DC140V/AC60V between the inputs

Structure

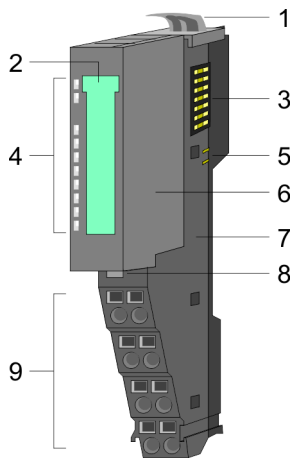

- 1 Locking lever terminal module
- 2 Labeling strip
- 3 Backplane bus
- 4 LED status indication
- 5 DC 24V power section supply
- 6 Electronic module
- 7 Terminal module
- 8 Locking lever electronic module
- 9 Terminal

Status indication

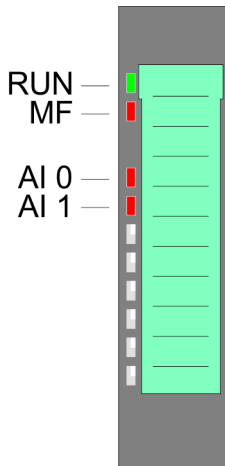

RUN	MF	AI x	Description
<input checked="" type="checkbox"/> green	<input checked="" type="checkbox"/> red	<input checked="" type="checkbox"/> red	
<input checked="" type="checkbox"/>	<input type="checkbox"/>	X	Bus communication is OK Module status is OK
<input checked="" type="checkbox"/>	<input checked="" type="checkbox"/>	X	Bus communication is OK Module status reports an error
<input type="checkbox"/>	<input checked="" type="checkbox"/>	X	Bus communication is not possible Module status reports an error
<input type="checkbox"/>	<input type="checkbox"/>	X	Error at bus power supply
X	<input checked="" type="checkbox"/> 2Hz	X	Error in configuration Chap. 2.8 'Trouble shooting - LEDs' page 30
<input checked="" type="checkbox"/>	<input type="checkbox"/>	<input checked="" type="checkbox"/>	Error channel x <ul style="list-style-type: none"> ■ Signal leaves measuring range ■ Error in parameterization ■ Wire break (if parameterized)
not relevant: X			

Pin assignment

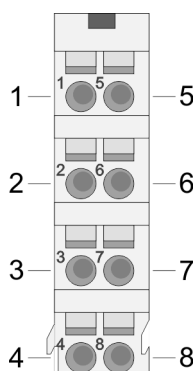

For wires with a cross section of 0.08mm² up to 1.5mm².

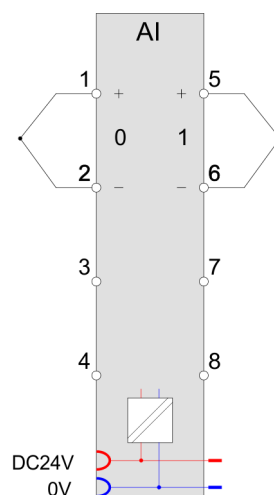

Pos.	Function	Type	Description
1	+TC 0	I	+ Channel 0
2	-TC 0	I	Ground Channel 0
3	---	---	not connected
4	---	---	not connected
5	+TC 1	I	+ Channel 1
6	-TC 1	I	Ground Channel 1
7	---	---	not connected
8	---	---	not connected

I: Input

**CAUTION!**

Please consider that the electronic module AI 2x16Bit TC may exclusively be used together with the terminal module 001-0AA20!



*Please take care of the correct polarity when installing the sensors!
Please install short circuits at non-used inputs by connecting the positive contact with the channel ground of the according channel.*

Supplementation to the installation guidelines

To avoid variations in temperature within the module, which may affect the accuracy of the measurement, you should consider the following points when assembling:

- Do not arrange the module directly apart from a power module with a high feeding current.
- Do not install the module at the end of a line.
- The module should be in a static condition, i.e. the temperature should be as constant as possible in the environment of your module (closed switchgear cabinet free from air draught).
- The accuracy is reached after approx. 30 minutes after entering the static condition.

In-/Output area

At CPU, PROFIBUS and PROFINET the input respectively output area is embedded to the corresponding address area.

IX - Index for access via CANopen with s = Subindex, depends on number and type of analog modules

SX - Subindex for access via EtherCAT with Index 6000h + EtherCAT-Slot

More can be found in the according manual of your bus coupler.

Input area

Addr.	Name	Bytes	Function	IX	SX
+0	AI 0	2	Analog value channel 0	6401h/s	01h
+2	AI 1	2	Analog value channel 1	6401h/s+1	02h

Output area

No byte of the output area is used by the module.

3.25.1 Technical data

Order no.	031-1LB90
Type	SM 031
Module ID	040F 1543
Current consumption/power loss	
Current consumption from backplane bus	55 mA
Power loss	1 W
Technical data analog inputs	
Number of inputs	2
Cable length, shielded	200 m
Rated load voltage	DC 24 V
Current consumption from load voltage L+ (without load)	30 mA
Voltage inputs	-
Min. input resistance (voltage range)	10 MΩ
Input voltage ranges	-80 mV ... +80 mV
Operational limit of voltage ranges	±0.3%
Operational limit of voltage ranges with SFU	±0.1%
Basic error limit voltage ranges	±0.25%
Basic error limit voltage ranges with SFU	±0.05%
Destruction limit voltage	max. 20V
Current inputs	-
Max. input resistance (current range)	-
Input current ranges	-
Operational limit of current ranges	-

Order no.	031-1LB90
Operational limit of current ranges with SFU	-
Basic error limit current ranges	-
Radical error limit current ranges with SFU	-
Destruction limit current inputs (voltage)	-
Destruction limit current inputs (electrical current)	-
Resistance inputs	-
Resistance ranges	-
Operational limit of resistor ranges	-
Operational limit of resistor ranges with SFU	-
Basic error limit	-
Basic error limit with SFU	-
Destruction limit resistance inputs	-
Resistance thermometer inputs	-
Resistance thermometer ranges	-
Operational limit of resistance thermometer ranges	-
Operational limit of resistance thermometer ranges with SFU	-
Basic error limit thermoresistor ranges	-
Basic error limit thermoresistor ranges with SFU	-
Destruction limit resistance thermometer inputs	-
Thermocouple inputs	✓
Thermocouple ranges	type B type C type E type J type K type L type N type R type S type T
Operational limit of thermocouple ranges	Type E, L, T, J, K, N: $\pm 2.5K$ / Type B, C, R, S: $\pm 8.0K$
Operational limit of thermocouple ranges with SFU	Type E, L, T, J, K, N: $\pm 1.5K$ / Type B, C, R, S: $\pm 4.0K$
Basic error limit thermoelement ranges	Type E, L, T, J, K, N: $\pm 2.0K$ / Type B, C, R, S: $\pm 7.0K$
Basic error limit thermoelement ranges with SFU	Type E, L, T, J, K, N: $\pm 1.0K$ / Type B, C, R, S: $\pm 3.0K$
Destruction limit thermocouple inputs	max. 20V
Programmable temperature compensation	✓

Order no.	031-1LB90
External temperature compensation	✓
Internal temperature compensation	✓
Temperature error internal compensation	1 K
Technical unit of temperature measurement	°C, °F, K
Resolution in bit	16
Measurement principle	Sigma-Delta
Basic conversion time	84.2 ms (50 Hz) 70.5 ms (60 Hz) per channel
Noise suppression for frequency	>90dB at 50Hz (UCM<10V)
Status information, alarms, diagnostics	
Status display	yes
Interrupts	yes
Process alarm	no
Diagnostic interrupt	yes, parameterizable
Diagnostic functions	yes
Diagnostics information read-out	possible
Module state	green LED
Module error display	red LED
Channel error display	red LED per channel
Isolation	
Between channels	-
Between channels of groups to	-
Between channels and backplane bus	✓
Between channels and power supply	-
Max. potential difference between circuits	-
Max. potential difference between inputs (Ucm)	DC 75 V/ AC 50 V
Max. potential difference between Mana and Mintern (Uiso)	-
Max. potential difference between inputs and Mana (Ucm)	-
Max. potential difference between inputs and Mintern (Uiso)	DC 75 V/ AC 50 V
Max. potential difference between Mintern and outputs	-
Insulation tested with	DC 500 V
Datasizes	
Input bytes	4
Output bytes	0
Parameter bytes	10
Diagnostic bytes	20

Order no.	031-1LB90
Housing	
Material	PPE / PPE GF10
Mounting	Profile rail 35 mm
Mechanical data	
Dimensions (WxHxD)	12.9 mm x 109 mm x 76.5 mm
Net weight	58 g
Weight including accessories	58 g
Gross weight	72 g
Environmental conditions	
Operating temperature	0 °C to 60 °C
Storage temperature	-25 °C to 70 °C
Certifications	
UL certification	yes
KC certification	yes

SFU - Interference frequency suppression

The indicated error limits are valid starting from the following temperatures:

- Thermoelement type T: -200 °C
- Thermoelement type K: -100 °C
- Thermoelement type B: +700 °C
- Thermoelement type N: -150 °C
- Thermoelement type E: -150 °C
- Thermoelement type R: +200 °C
- Thermoelement type S: +100 °C
- Thermoelement type J: -100 °C

3.25.2 Parameter data

DS - Record set for access via CPU, PROFIBUS and PROFINET

IX - Index for access via CANopen

SX - Subindex for access via EtherCAT with Index 3100h + EtherCAT-Slot

More can be found in the according manual of your bus coupler.

Name	Bytes	Function	Default	DS	IX	SX
DIAG_EN	1	Diagnostics*	00h	00h	3100h	01h
WIBRK_EN	1	Wire break recognition*	00h	00h	3101h	02h
TEMPCNF	1	Temperature system	00h	01h	3102h	03h
SUPR	1	Interference frequency suppression (SFU)	02h	01h	3103h	04h
CH0FN	1	Function number channel 0	C1h	80h	3104h	05h
CH1FN	1	Function number channel 1	C1h	81h	3105h	06h

* This record set may only be transferred at STOP state.

DIAG_EN Diagnostic interrupt

Byte	Bit 7 ... 0
0	<ul style="list-style-type: none"> ■ Diagnostic interrupt <ul style="list-style-type: none"> – 00h: disabled – 40h: enabled

- Here you can enable respectively disable the diagnostic interrupt.

WIBRK_EN Wire break recognition

Byte	Bit 7 ... 0
0	<ul style="list-style-type: none"> ■ Bit 0: Wire break recognition channel 0 (1: on) ■ Bit 1: Wire break recognition channel 1 (1: on) ■ Bit 7 ... 2: reserved



Due to the high sensitivity of the inputs, unused inputs should be deactivated in the parametrization. Due to the high input impedance, open inputs can be influenced by adjacent channels or due to the measuring method during wire break detection. Since the entire measuring range moves in the mV range, open-loop inputs can already cause measuring range overshoots.

TEMPCNF Temperature system

Byte	Bit 7 ... 0
0	<ul style="list-style-type: none"> ■ Bit 0, 1: Temperature system <ul style="list-style-type: none"> – 00: °C – 01: °F – 10: K ■ Bit 7 ... 2: reserved

SUPR Interference frequency suppression (SFU)

Byte	Bit 7 ... 0
0	<ul style="list-style-type: none"> ■ Bit 0, 1: Interference frequency suppression <ul style="list-style-type: none"> – 01: 60Hz – 10: 50Hz ■ Bit 7 ... 2: reserved

CHxFN Function number channel x

In the following there are the measuring ranges with corresponding function number listed, which were supported by the analog module. With FFh the corresponding channel is deactivated.

Voltage**-80 ... 80mV**

Meas. range (funct. no.)	Voltage (U)	Decimal (D)	Hex	Range	Formulas
-80 ... 80mV Siemens S7 format (11h)	94.07mV	32511	7EFFh	overrange	$D = 27648 \cdot \frac{U}{80}$ $U = D \cdot \frac{80}{27648}$
	80mV	27648	6C00h	nominal range	
	0V	0	0000h		
	-80mV	-27648	9400h		
	-94.07mV	-32512	8100h	underrange	
-80 ... 80mV Siemens S5 format (21h)	100mV	20480	5000h	overrange	$D = 16384 \cdot \frac{U}{80}$ $U = D \cdot \frac{80}{16384}$
	80mV	16384	4000h	nominal range	
	0V	0	0000h		
	-80mV	-16384	C000h		
	-100mV	-20480	B000h	underrange	

Temperature

Measuring range (funct. no.)	Measuring value in °C (0.1°C/digit)	Measuring value in °F (0.1°F/digit)	Measuring value in K (0.1K/digit)	Range
Type J: [Fe-Cu-Ni IEC] -210 ... +1200°C -346 ... 2192°F 63.2 ... 1473.2K (B0h: ext. comp. 0°C) (C0h: int. comp. 0°C)	+14500	26420	17232	overrange
	-2100 ... +12000	-3460 ... 21920	632 ... 14732	nominal range
	---	---	---	underrange
Type K: [Ni-Cr-Ni] -270 ... +1372°C -454 ... 2501.6°F	+16220	29516	18952	overrange
	-2700 ... +13720	-4540 ... 25016	0 ... 16452	nominal range

031-1LB90 - AI 2x16Bit TC > Parameter data

Measuring range (funct. no.)	Measuring value in °C (0.1°C/digit)	Measuring value in °F (0.1°F/digit)	Measuring value in K (0.1K/digit)	Range
0 ... 1645.2K (B1h: ext. comp. 0°C) (C1h: int. comp. 0°C)	---	---	---	underrange
Type N:	+15500	28220	18232	overrange
[Ni-Cr-Si]	-2700 ... +13000	-4540 ... 23720	0 ... 15732	nominal range
-270 ... +1300°C -454 ... 2372°F	---	---	---	underrange
0 ... 1573.2K (B2h: ext. comp. 0°C) (C2h: int. comp. 0°C)				
Type R:	+20190	32766	22922	overrange
[PtRh-Pt]	-500 ... +17690	-580 ... 32162	2232 ... 20422	nominal range
-50 ... +1769°C -58 ... 3216.2°F	-1700	-2740	1032	underrange
223.2 ... 2042.2K (B3h: ext. comp. 0°C) (C3h: int. comp. 0°C)				
Type S:	+20190	32766	22922	overrange
[PtRh-Pt]	-500 ... +17690	-580 ... 32162	2232 ... 20422	nominal range
-50 ... +1769°C -58 ... 3216.2°F	-1700	-2740	1032	underrange
223.2 ... 2042.2K (B4h: ext. comp. 0°C) (C4h: int. comp. 0°C)				
Type T:	+5400	10040	8132	overrange
[Cu-Cu-Ni]	-2700 ... +4000	-4540 ... 7520	32 ... 6732	nominal range
-270 ... +400°C -454 ... 752°F	---	---	---	underrange
3.2 ... 673.2K (B5h: ext. comp. 0°C) (C5h: int. comp. 0°C)				
Type B:	+20700	32766	23432	overrange
[PtRh-PtRh]	0 ... +18200	320 ... 27865	2732 ... 20932	nominal range
0 ... +1820°C 32 ... 2786.5°F	-1200	-1840	1532	underrange
273.2 ... 2093.2K (B6h: ext. comp. 0°C) (C6h: int. comp. 0°C)				

Measuring range (funct. no.)	Measuring value in °C (0.1°C/digit)	Measuring value in °F (0.1°F/digit)	Measuring value in K (0.1K/digit)	Range
Type C: [WRe5-WRe26] 0 ... +2315°C 32 ... 2786.5°F 273.2 ... 2093.2K (B7h: ext. comp. 0°C) (C7h: int. comp. 0°C)	+25000 0 ... +23150 -1200	32766 320 ... 27865 -1840	23432 2732 ... 20932 1532	overrange nominal range underrange
Type E: [Ni-Cr - Cu-Ni] -270 ... +1000°C -454 ... 1832°F 0 ... 1273.2K (B8h: ext. comp. 0°C) (C8h: int. comp. 0°C)	+12000 -2700 ... +10000 ---	21920 -4540 ... 18320 ---	14732 0 ... 12732 ---	overrange nominal range underrange
Type L: [Fe-Cu-Ni] -200 ... +900°C -328 ... 1652°F 73.2 ... 1173.2K (B9h: ext. comp. 0°C) (C9h: int. comp. 0°C)	+11500 -2000 ... +9000 ---	21020 -3280 ... 16520 ---	14232 732 ... 11732 ---	overrange nominal range underrange

3.25.3 Diagnostic data

So this module does not support diagnostic interrupt functions, the diagnostics data serve for information about this module. On error the corresponding channel LED of the module is activated and the error is registered in the diagnostics data.

The following errors are listed in the diagnostics data:

- Error in project engineering / parameterization
- Measuring range overflow
- Measuring range underflow

DS - Record set for access via CPU, PROFIBUS and PROFINET. The access happens by DS 01h. Additionally the first 4 bytes may be accessed by DS 00h.

IX - Index for access via CANopen. The access happens by IX 2F01h. Additionally the first 4 bytes may be accessed by IX 2F00h.

SX - Subindex for access via EtherCAT with Index 5005h.

More can be found in the according manual of your bus coupler.

031-1LB90 - AI 2x16Bit TC > Diagnostic data

Name	Bytes	Function	Default	DS	IX	SX
ERR_A	1	Diagnostic	00h	01h	2F01h	02h
MODTYP	1	Module information	15h			03h
RES2	1	reserved	00h			04h
ERR_D	1	Diagnostic	00h			05h
CHTYP	1	Channel type	71h			06h
NUMBIT	1	Number diagnostic bits per channel	08h			07h
NUMCH	1	Number of channels of a module	02h			08h
CHERR	1	Channel error	00h			09h
CH0ERR	1	Channel-specific error channel 0	00h			0Ah
CH1ERR	1	Channel-specific error channel 1	00h			0Bh
CH2ERR... CH7ERR	6	reserved	00h			0Ch ... 11h
DIAG_US	4	µs ticker	00h			13h

ERR_A Diagnostic

Byte	Bit 7 ... 0
0	<ul style="list-style-type: none"> ■ Bit 0: set at module failure ■ Bit 1: set at internal error ■ Bit 2: set at external error ■ Bit 3: set at channel error ■ Bit 4: set at external auxiliary supply missing ■ Bit 6 ... 5: reserved ■ Bit 7: set at error in parameterization

MODTYP Module information

Byte	Bit 7 ... 0
0	<ul style="list-style-type: none"> ■ Bit 3 ... 0: module class <ul style="list-style-type: none"> – 0101b analog module ■ Bit 4: set at channel information present ■ Bit 7 ... 5: reserved

ERR_D Diagnostic

Byte	Bit 7 ... 0
0	<ul style="list-style-type: none"> ■ Bit 2 ... 0: reserved ■ Bit 3: set at internal diagnostics buffer overflow ■ Bit 4: set at internal communication error ■ Bit 7 ... 5: reserved

CHTYP Channel type

Byte	Bit 7 ... 0
0	<ul style="list-style-type: none"> ■ Bit 6 ... 0: Channel type <ul style="list-style-type: none"> – 70h: Digital input – 71h: Analog input – 72h: Digital output – 73h: Analog output – 74h: Analog input/-output – 76h: Counter ■ Bit 7: reserved

NUMBIT Diagnostic bits

Byte	Bit 7 ... 0
0	Number of diagnostic bits per channel (here 08h)

NUMCH Channels

Byte	Bit 7 ... 0
0	Number of channels of a module (here 02h)

CHERR Channel error

Byte	Bit 7 ... 0
0	<ul style="list-style-type: none"> ■ Bit 0: set at error in channel group 0 ■ Bit 1: set at error in channel group 1 ■ Bit 7 ... 2: reserved

**CH0ERR / CH1ERR
Channel-specific**

Byte	Bit 7 ... 0
0	Channel-specific error: Channel x: <ul style="list-style-type: none"> ■ Bit 0: set at project engineering/parameterization error ■ Bit 3 ... 1: reserved ■ Bit 4: set at wire break ■ Bit 5: reserved ■ Bit 6: set at measuring range underflow ■ Bit 7: set at measuring range overflow

**CH2ERR ... CH7ERR
reserved**

Byte	Bit 7 ... 0
0	reserved

DIAG_US μ s ticker

Byte	Bit 7 ... 0
0...3	Value of the μ s ticker at the moment of the diagnostic

 μ s ticker

In the System SLIO module there is a timer (μ s ticker). With PowerON the timer starts counting with 0. After $2^{32}-1\mu$ s the timer starts with 0 again.

3.26 031-1LD80 - AI 4x16Bit R/RTD

Properties

The electronic module has 4 inputs for resistance measurement with parameterizable functions. The channels of the module are isolated to the backplane bus.

- 4 analog inputs
- Suited for resistance-type sensors 0 ... 3000Ω and resistance temperature sensors Pt100, Pt1000, NI100, NI120 and NI1000
- Resistance measurement with 2, 3 and 4 wire (3 and 4 wire only via channel 0 respectively 1)
- Diagnostics function
- 16bit resolution

Structure

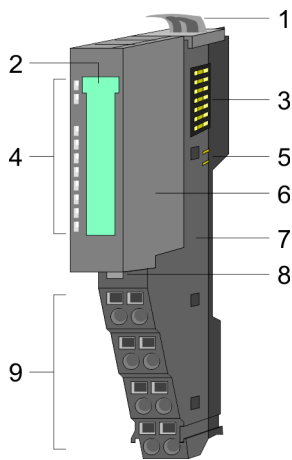

- 1 Locking lever terminal module
- 2 Labeling strip
- 3 Backplane bus
- 4 LED status indication
- 5 DC 24V power section supply
- 6 Electronic module
- 7 Terminal module
- 8 Locking lever electronic module
- 9 Terminal

Status indication

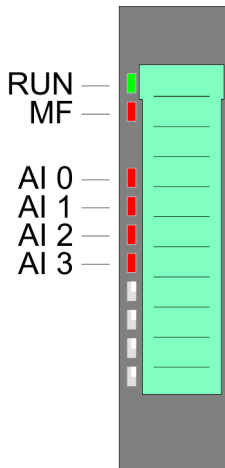

RUN	MF	AI x	Description
■ green	■ red	■ red	
■	<input type="checkbox"/>	X	Bus communication is OK Module status is OK
■	■	X	Bus communication is OK Module status reports an error
<input type="checkbox"/>	■	X	Bus communication is not possible Module status reports an error
<input type="checkbox"/>	<input type="checkbox"/>	X	Error at bus power supply
X	▣ 2Hz	X	Error in configuration ↗ <i>Chap. 2.8 'Trouble shooting - LEDs' page 30</i>
■	<input type="checkbox"/>	■	Error channel x <ul style="list-style-type: none"> ■ Signal leaves measuring range ■ Error in parameterization ■ Wire break (if parameterized)

not relevant: X

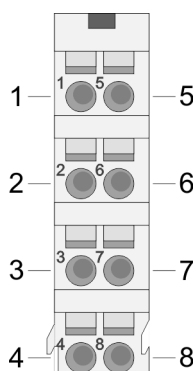
Pin assignment

For wires with a cross section of 0.08mm² up to 1.5mm².

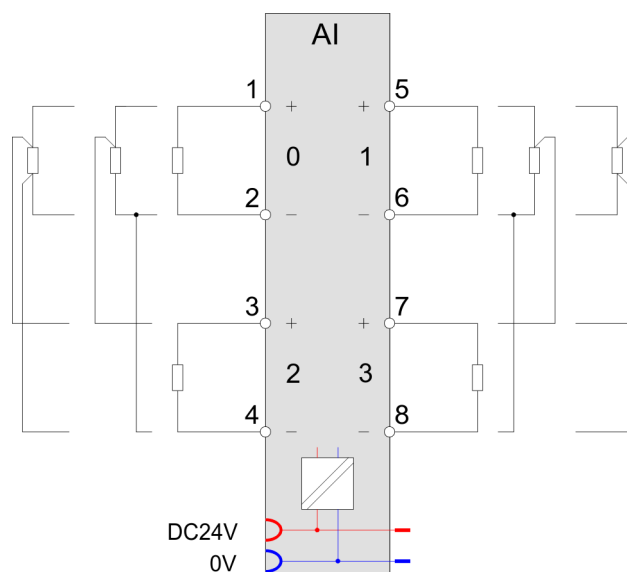

Pos.	Function	Type	Description
1	+AI 0	I	+ Channel 0
2	-AI 0	I	Ground Channel 0
3	+AI 2	I	+ Channel 2
4	-AI 2	I	Ground Channel 2
5	+AI 1	I	+ Channel 1
6	-AI 1	I	Ground Channel 1
7	+AI 3	I	+ Channel 3
8	-AI 3	I	Ground Channel 3

I: Input

2, 3, 4 wire measurement

At the pin assignment above you can see how the sensors are to be connected at 2, 3 respectively 4 wire measurement.

- With every channel a 2 wire measurement may be performed.
- 3 wire measurement is only possible via the channels 0 and 1.
 - Please consider with 3 wire measurement that the corresponding channel is always deactivated in the parametrization. The corresponding channel of channel 0 is channel 2 and of channel 1 is channel 3. Not used channels must always be de-activated in the parametrization.
- 4 wire measurement is only possible via the channels 0 and 1.
 - The measurement current for channel 0 is applied at pin 1 and 2. The measurement for channel 0 happens at pin 3 and 4. The analog value for channel 0 is represented in input word 0.
 - The measurement current for channel 1 is applied at pin 5 and 6. The measurement for channel 1 happens at pin 7 and 8. The analog value for channel 1 is represented in input word 1.
 - Please consider with 4 wire measurement that the corresponding channel is always deactivated in the parametrization. The corresponding channel of channel 0 is channel 2 and of channel 1 is channel 3. Not used channels must always be de-activated in the parametrization.

In-/Output area

At CPU, PROFIBUS and PROFINET the input respectively output area is embedded to the corresponding address area.

IX - Index for access via CANopen with s = Subindex, depends on number and type of analog modules

SX - Subindex for access via EtherCAT with Index 6000h + EtherCAT-Slot

More can be found in the according manual of your bus coupler.

Input area

Addr.	Name	Bytes	Function	IX	SX
+0	AI 0	2	Analog value channel 0	6401h/s	01h
+2	AI 1	2	Analog value channel 1	6401h/s+1	02h
+4	AI 2	2	Analog value channel 2	6401h/s+2	03h
+6	AI 3	2	Analog value channel 3	6401h/s+3	04h

Output area

No byte of the output area is used by the module.

3.26.1 Technical data

Order no.	031-1LD80
Type	SM 031
Module ID	0410 1544
Current consumption/power loss	
Current consumption from backplane bus	55 mA
Power loss	1 W
Technical data analog inputs	
Number of inputs	4
Cable length, shielded	200 m
Rated load voltage	DC 24 V
Current consumption from load voltage L+ (without load)	30 mA
Voltage inputs	-
Min. input resistance (voltage range)	-
Input voltage ranges	-
Operational limit of voltage ranges	-
Operational limit of voltage ranges with SFU	-
Basic error limit voltage ranges	-
Basic error limit voltage ranges with SFU	-
Destruction limit voltage	-
Current inputs	-
Max. input resistance (current range)	-

Order no.	031-1LD80
Input current ranges	-
Operational limit of current ranges	-
Operational limit of current ranges with SFU	-
Basic error limit current ranges	-
Radical error limit current ranges with SFU	-
Destruction limit current inputs (voltage)	-
Destruction limit current inputs (electrical current)	-
Resistance inputs	✓
Resistance ranges	0 ... 60 Ohm 0 ... 600 Ohm 0 ... 3000 Ohm
Operational limit of resistor ranges	+/- 0.4 %
Operational limit of resistor ranges with SFU	+/- 0,2 %
Basic error limit	+/- 0.2 %
Basic error limit with SFU	+/- 0,1 %
Destruction limit resistance inputs	max. 24V
Resistance thermometer inputs	✓
Resistance thermometer ranges	Pt100 Pt1000 Ni100 Ni120 Ni1000
Operational limit of resistance thermometer ranges	+/- 0.4 %
Operational limit of resistance thermometer ranges with SFU	+/- 0,2 %
Basic error limit thermoresistor ranges	+/- 0.2 %
Basic error limit thermoresistor ranges with SFU	+/- 0,1 %
Destruction limit resistance thermometer inputs	max. 24V
Thermocouple inputs	-
Thermocouple ranges	-
Operational limit of thermocouple ranges	-
Operational limit of thermocouple ranges with SFU	-
Basic error limit thermoelement ranges	-
Basic error limit thermoelement ranges with SFU	-
Destruction limit thermocouple inputs	-
Programmable temperature compensation	-
External temperature compensation	-

Order no.	031-1LD80
Internal temperature compensation	-
Temperature error internal compensation	-
Technical unit of temperature measurement	°C, °F, K
Resolution in bit	16
Measurement principle	Sigma-Delta
Basic conversion time	84.2 ms (50 Hz) 70.5 ms (60 Hz) per channel
Noise suppression for frequency	>80dB at 50Hz (UCM<6V)
Status information, alarms, diagnostics	
Status display	yes
Interrupts	yes, parameterizable
Process alarm	no
Diagnostic interrupt	yes, parameterizable
Diagnostic functions	yes
Diagnostics information read-out	possible
Module state	green LED
Module error display	red LED
Channel error display	red LED per channel
Isolation	
Between channels	-
Between channels of groups to	-
Between channels and backplane bus	✓
Between channels and power supply	-
Max. potential difference between circuits	-
Max. potential difference between inputs (Ucm)	DC 6 V
Max. potential difference between Mana and Mintern (Uiso)	-
Max. potential difference between inputs and Mana (Ucm)	-
Max. potential difference between inputs and Mintern (Uiso)	DC 75 V/ AC 50 V
Max. potential difference between Mintern and outputs	-
Insulation tested with	DC 500 V
Technical data encoder supply	
Number of outputs	-
Output voltage (typ)	-
Output voltage (rated value)	-
Short-circuit protection	-
Binding of potential	-

Order no.	031-1LD80
Datasizes	
Input bytes	8
Output bytes	0
Parameter bytes	12
Diagnostic bytes	20
Housing	
Material	PPE / PPE GF10
Mounting	Profile rail 35 mm
Mechanical data	
Dimensions (WxHxD)	12.9 mm x 109 mm x 76.5 mm
Net weight	61 g
Weight including accessories	61 g
Gross weight	75 g
Environmental conditions	
Operating temperature	0 °C to 60 °C
Storage temperature	-25 °C to 70 °C
Certifications	
UL certification	yes
KC certification	yes

SFU - Interference frequency suppression

3.26.2 Parameter data

DS - Record set for access via CPU, PROFIBUS and PROFINET

IX - Index for access via CANopen

SX - Subindex for access via EtherCAT with Index 3100h + EtherCAT-Slot

More can be found in the according manual of your bus coupler.

Name	Bytes	Function	Default	DS	IX	SX
DIAG_EN	1	Diagnostic ¹	00h	00h	3100h	01h
WIBRK_EN	1	Wire break recognition ¹	00h	00h	3101h	02h
TEMPCNF	1	Temperature system	00h	01h	3102h	03h
SUPR	1	Interference frequency suppression (SFU)	02h	01h	3103h	04h
CH0FN	1	Function number channel 0	50h	80h	3104h	05h
CH1FN	1	Function number channel 1	50h	81h	3105h	06h
CH2FN	1	Function number channel 2	50h ²	82h	3106h	07h
CH3FN	1	Function number channel 3	50h ²	83h	3107h	08h

1) This record set may only be transferred at STOP state.

2) with 2 channel operation FFh

DIAG_EN Diagnostic interrupt

Byte	Bit 7 ... 0
0	<ul style="list-style-type: none"> ■ Diagnostic interrupt <ul style="list-style-type: none"> – 00h: disabled – 40h: enabled

■ Here you can enable respectively disable the diagnostic interrupt.

WIBRK_EN Wire break recognition

Byte	Bit 7 ... 0
0	<ul style="list-style-type: none"> ■ Bit 0: Wire break recognition channel 0 (1: on) ■ Bit 1: Wire break recognition channel 1 (1: on) ■ Bit 2: Wire break recognition channel 2 (1: on) ■ Bit 3: Wire break recognition channel 3 (1: on) ■ Bit 7 ... 4: reserved

TEMPCNF Temperature system

Byte	Bit 7 ... 0
0	<ul style="list-style-type: none"> ■ Bit 1, 0: Temperature system <ul style="list-style-type: none"> – 00: °C – 01: °F – 10: K ■ Bit 7 ... 2: reserved

SUPR Interference frequency suppression (SFU)

Byte	Bit 7 ... 0
0	<ul style="list-style-type: none"> ■ Bit 1, 0: Interference frequency suppression <ul style="list-style-type: none"> – 01: 60Hz – 10: 50Hz ■ Bit 7 ... 2: reserved

CHxFN Function number channel x

In the following there are the measuring ranges with corresponding function number listed, which were supported by the analog module. With FFh the corresponding channel is deactivated.

Measuring range (funct. no.)	Measuring value	Signal range	Range
2 wire: PT100 (50h)	+1000°C	+10000	overrange
	-200 ... +850°C	-2000 ... +8500	nominal range
	-243°C	-2430	underrange
2 wire: PT1000 (51h)	+1000°C	+10000	overrange
	-200 ... +850°C	-2000 ... +8500	nominal range
	-243°C	-2430	underrange
2 wire: NI100 (52h)	+295°C	+2950	overrange
	-60 ... +250°C	-600 ... +2500	nominal range
	-105°C	-1050	underrange
2 wire: NI1000 (53h)	+295°C	+2950	overrange
	-60 ... +250°C	-600 ... +2500	nominal range
	-105°C	-1050	underrange
2 wire: NI120 (54h)	+300°C	+3000	overrange
	-80 ... +260°C	-800 ... +2600	nominal range
	-110°C	-1100	underrange
3 wire: PT100 (58h)	+1000°C	+10000	overrange
	-200 ... +850°C	-2000 ... +8500	nominal range
	-243°C	-2430	underrange
3 wire: PT1000 (59h)	+1000°C	+10000	overrange
	-200 ... +850°C	-2000 ... +8500	nominal range
	-243°C	-2430	underrange
3 wire: NI100 (5Ah)	+295°C	+2950	overrange
	-60 ... +250°C	-600 ... +2500	nominal range
	-105°C	-1050	underrange
3 wire: NI1000 (5Bh)	+295°C	+2950	overrange
	-60 ... +250°C	-600 ... +2500	nominal range
	-105°C	-1050	underrange

031-1LD80 - AI 4x16Bit R/RTD > Parameter data

Measuring range (funct. no.)	Measuring value	Signal range	Range
3 wire: NI120 (5Ch)	+300°C	+3000	overrange
	-80 ... +260°C	-800 ... +2600	nominal range
	-110°C	-1100	underrange
4 wire: PT100 (60h)	+1000°C	+10000	overrange
	-200 ... +850°C	-2000 ... +8500	nominal range
	-243°C	-2430	underrange
4 wire: PT1000 (61h)	+1000°C	+10000	overrange
	-200 ... +850°C	-2000 ... +8500	nominal range
	-243°C	-2430	underrange
4 wire: NI100 (62h)	+295°C	+2950	overrange
	-60 ... +250°C	-600 ... +2500	nominal range
	-105°C	-1050	underrange
4 wire: NI1000 (63h)	+295°C	+2950	overrange
	-60 ... +250°C	-600 ... +2500	nominal range
	-105°C	-1050	underrange
4 wire: NI120 (64h)	+300°C	+3000	overrange
	-80 ... +260°C	-800 ... +2600	nominal range
	-110°C	-1100	underrange
2 wire: 0 ... 60Ω (70h)	---	---	overrange
	0 ... 60Ω	0 ... 32767	nominal range
	---	---	underrange
2 wire: 0 ... 600Ω (71h)	---	---	overrange
	0 ... 600Ω	0 ... 32767	nominal range
	---	---	underrange
2 wire: 0 ... 3000Ω (72h)	---	---	overrange
	0 ... 3000Ω	0 ... 32767	nominal range
	---	---	underrange
3 wire: 0 ... 60Ω (78h)	---	---	overrange
	0 ... 60Ω	0 ... 32767	nominal range
	---	---	underrange
3 wire: 0 ... 600Ω (79h)	---	---	overrange
	0 ... 600Ω	0 ... 32767	nominal range
	---	---	underrange
3 wire: 0 ... 3000Ω (7Ah)	---	---	overrange
	0 ... 3000Ω	0 ... 32767	nominal range

Measuring range (funct. no.)	Measuring value	Signal range	Range
	---	---	underrange
4 wire: 0 ... 60Ω (80h)	---	---	overrange
	0 ... 60Ω	0 ... 32767	nominal range
	---	---	underrange
4 wire: 0 ... 600Ω (81h)	---	---	overrange
	0 ... 600Ω	0 ... 32767	nominal range
	---	---	underrange
4 wire: 0 ... 3000Ω (82h)	---	---	overrange
	0 ... 3000Ω	0 ... 32767	nominal range
	---	---	underrange
2 wire: 0 ... 60Ω (90h)	---	---	overrange
	0 ... 60Ω	0 ... 6000	nominal range
	---	---	underrange
2 wire: 0 ... 600Ω (91h)	---	---	overrange
	0 ... 600Ω	0 ... 6000	nominal range
	---	---	underrange
2 wire: 0 ... 3000Ω (92h)	---	---	overrange
	0 ... 3000Ω	0 ... 30000	nominal range
	---	---	underrange
3 wire: 0 ... 60Ω (98h)	---	---	overrange
	0 ... 60Ω	0 ... 6000	nominal range
	---	---	underrange
3 wire: 0 ... 600Ω (99h)	---	---	overrange
	0 ... 600Ω	0 ... 6000	nominal range
	---	---	underrange
3 wire: 0 ... 3000Ω (9Ah)	---	---	overrange
	0 ... 3000Ω	0 ... 30000	nominal range
	---	---	underrange
4 wire: 0 ... 60Ω (A0h)	---	---	overrange
	0 ... 60Ω	0 ... 6000	nominal range
	---	---	underrange
4 wire: 0 ... 600Ω (A1h)	---	---	overrange
	0 ... 600Ω	0 ... 6000	nominal range
	---	---	underrange
4 wire: 0 ... 3000Ω	---	---	overrange

Measuring range (funct. no.)	Measuring value	Signal range	Range
(A2h)	0 ... 3000Ω	0 ... 30000	nominal range
	---	---	underrange
	---	---	underrange
2 wire: 0 ... 60Ω (D0h)	70.55Ω	32511	overrange
	0 ... 60Ω	0 ... 27648	nominal range
	---	---	underrange
2 wire: 0 ... 600Ω (D1h)	705.5Ω	32511	overrange
	0 ... 600Ω	0 ... 27648	nominal range
	---	---	underrange
2 wire: 0 ... 3000Ω (D2h)	3528Ω	32511	overrange
	0 ... 3000Ω	0 ... 27648	nominal range
	---	---	underrange
3 wire: 0 ... 60Ω (D8h)	70.55Ω	32511	overrange
	0 ... 60Ω	0 ... 27648	nominal range
	---	---	underrange
3 wire: 0 ... 600Ω (D9h)	705.5Ω	32511	overrange
	0 ... 600Ω	0 ... 27648	nominal range
	---	---	underrange
3 wire: 0 ... 3000Ω (DAh)	3528Ω	32511	overrange
	0 ... 3000Ω	0 ... 27648	nominal range
	---	---	underrange
4 wire: 0 ... 60Ω (E0h)	70.55Ω	32511	overrange
	0 ... 60Ω	0 ... 27648	nominal range
	---	---	underrange
4 wire: 0 ... 600Ω (E1h)	705.5Ω	32511	overrange
	0 ... 600Ω	0 ... 27648	nominal range
	---	---	underrange
4 wire: 0 ... 3000Ω (E2h)	3528Ω	32511	overrange
	0 ... 3000Ω	0 ... 27648	nominal range
	---	---	underrange

3.26.3 Diagnostic data

So this module does not support diagnostic interrupt functions, the diagnostics data serve for information about this module. On error the corresponding channel LED of the module is activated and the error is registered in the diagnostics data.

The following errors are listed in the diagnostics data:

- Error in project engineering / parameterization
- Measuring range overflow
- Measuring range underflow

DS - Record set for access via CPU, PROFIBUS and PROFINET. The access happens by DS 01h. Additionally the first 4 bytes may be accessed by DS 00h.

IX - Index for access via CANopen. The access happens by IX 2F01h. Additionally the first 4 bytes may be accessed by IX 2F00h.

SX - Subindex for access via EtherCAT with Index 5005h.

More can be found in the according manual of your bus coupler.

Name	Bytes	Function	Default	DS	IX	SX
ERR_A	1	Diagnostic	00h	01h	2F01h	02h
MODTYP	1	Module information	15h			03h
ERR_C	1	reserved	00h			04h
ERR_D	1	Diagnostic	00h			05h
CHTYP	1	Channel type	71h			06h
NUMBIT	1	Number diagnostic bits per channel	08h			07h
NUMCH	1	Number of channels of a module	04h			08h
CHERR	1	Channel error	00h			09h
CH0ERR	1	Channel-specific error channel 0	00h			0Ah
CH1ERR	1	Channel-specific error channel 1	00h			0Bh
CH2ERR	1	Channel-specific error channel 2	00h			0Ch
CH3ERR	1	Channel-specific error channel 3	00h			0Dh
CH4ERR...CH7ERR	4	reserved	00h			0Eh ... 11h
DIAG_US	4	µs ticker	00h			13h

ERR_A Diagnostic

Byte	Bit 7 ... 0
0	<ul style="list-style-type: none"> ■ Bit 0: set at module failure ■ Bit 1: set at internal error ■ Bit 2: set at external error ■ Bit 3: set at channel error ■ Bit 4: set at external auxiliary supply missing ■ Bit 6 ... 5: reserved ■ Bit 7: set at error in parameterization

031-1LD80 - AI 4x16Bit R/RTD > Diagnostic data

MODTYP Module information

Byte	Bit 7 ... 0
0	<ul style="list-style-type: none"> ■ Bit 3 ... 0: module class <ul style="list-style-type: none"> – 0101b analog module ■ Bit 4: set at channel information present ■ Bit 7 ... 5: reserved

ERR_D Diagnostic

Byte	Bit 7 ... 0
0	<ul style="list-style-type: none"> ■ Bit 2 ... 0: reserved ■ Bit 3: set at internal diagnostics buffer overflow ■ Bit 4: set at internal communication error ■ Bit 7 ... 5: reserved

CHTYP Channel type

Byte	Bit 7 ... 0
0	<ul style="list-style-type: none"> ■ Bit 6 ... 0: Channel type <ul style="list-style-type: none"> – 70h: Digital input – 71h: Analog input – 72h: Digital output – 73h: Analog output – 74h: Analog input/output – 76h: Counter ■ Bit 7: reserved

NUMBIT Diagnostic bits

Byte	Bit 7 ... 0
0	Number of diagnostic bits per channel (here 08h)

NUMCH Channels

Byte	Bit 7 ... 0
0	Number of channels of a module (here 04h)

CHERR Channel error

Byte	Bit 7 ... 0
0	<ul style="list-style-type: none"> ■ Bit 0: set at error in channel group 0 ■ Bit 1: set at error in channel group 1 ■ Bit 2: set at error in channel group 2 ■ Bit 3: set at error in channel group 3 ■ Bit 7 ... 4: reserved

CH0ERR ... CH3ERR
Channel-specific

Byte	Bit 7 ... 0
0	Channel-specific error: channel x: <ul style="list-style-type: none"> ■ Bit 0: set at error in project engineering/parameterization ■ Bit 3 ... 1: reserved ■ Bit 4: set at wire break ■ Bit 5: reserved ■ Bit 6: set at measuring range underflow ■ Bit 7: set at measuring range overflow

CH4ERR ... CH7ERR
reserved

Byte	Bit 7 ... 0
0	reserved

DIAG_US μ s ticker

Byte	Bit 7 ... 0
0...3	Value of the μ s ticker at the moment of the diagnostic

 μ s ticker

In the System SLIO module there is a timer (μ s ticker). With PowerON the timer starts counting with 0. After $2^{32}-1\mu$ s the timer starts with 0 again.

031-1PAxx - AI1x 3Ph 230/400V

3.27 031-1PAxx - AI1x 3Ph 230/400V

Properties

The following modules are available:

- 031-1PA00: AI1x 3Ph 230/400V 1A
- 031-1PA10: AI1x 3Ph 230/400V 5A

The modules allow the measurement of electric data for counting energy and power measurement. Here, the voltage measurement of the individual phases is done directly (or indirectly via voltage transformers) and the current measurement indirectly via current transformers. When 5A current transformers are used, energy measurement can only be performed on devices in 3-phase operation. When 1A current transformers are used, the measurement inputs can be fed from the same phase.

- Retentive storage of the energy values
- Diagnostic function
- Resolution of the measured value 24bit
- The following measurands can be found in 4-quadrant operation:
 - Voltage, current
 - Electrical power
 - Electrical work
 - Harmonics
 - Phase shift $\cos \varphi$
 - Frequency

Structure

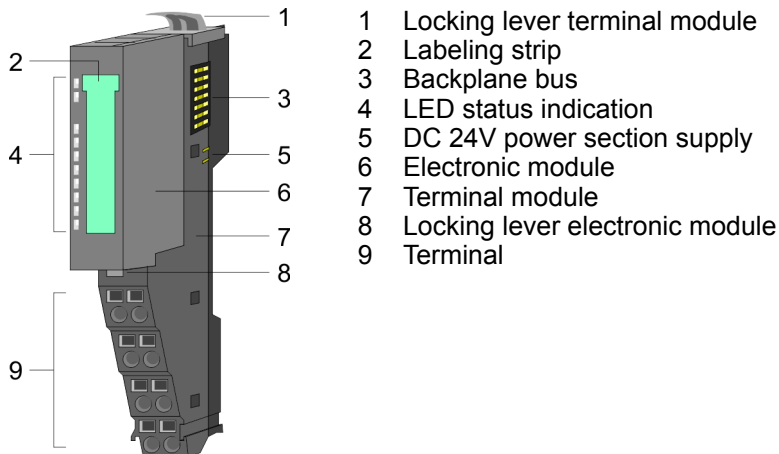

Status indication

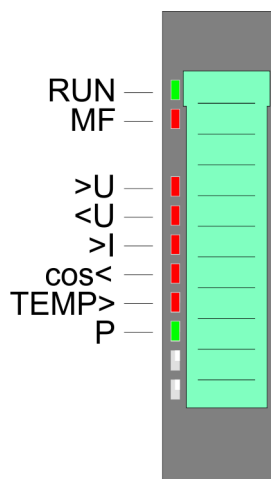

LED		Description
RUN	green	Bus communication is OK
		off: Error at bus power supply
MF	red	Module status reports an error Bus communication is not possible
		off: Module status is OK
	red 2Hz	Flashes: Error in configuration ↪ Chap. 2.8 'Trouble shooting - LEDs' page 30
>U		Voltage in the parametrized range
	red	Voltage limit value exceeded
<U		Voltage in the parametrized range
	red	Voltage limit value undershot (omitted in 1-phase operation)
>I		Current in the parametrized range
	red	Current limit value exceeded
cos<		Phase shift $\cos \varphi$ in the parametrized range
	red	Phase shift $\cos \varphi$ limit value undershot (omitted in 1-phase operation)
TEMP>		Temperature in the parametrized range
	red	Temperature limit value exceeded
P	green	P: Proportional power blinks with increasing frequency proportional to the active power at 20 pulses/Wh. The current transformer factor is not considered.



If the limit value is exceeded, the corresponding LED lights up. After the acknowledgment of the 'status bits' the corresponding LED goes out again.

031-1PA10 [↪ 'Status bits' page 335](#)

031-1PA00 [↪ 'Status bits' page 339](#)

Pin assignment

For wires with a core cross-section of 0.08mm² up to 1.5mm². The measurement of current respectively voltage is done indirectly by current respectively voltage transformers.
 ↪ Chap. 3.27.4 'Connection' page 324

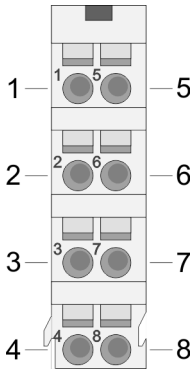

Pos.	Function	Type	Description
1	L1	I	Voltage measurement L1
2	L2	I	Voltage measurement L2
3	L3	I	Voltage measurement L3
4	N	I	Voltage measurement N
5	I _{L1}	I	Current measurement I _{L1}
6	I _{L2}	I	Current measurement I _{L2}
7	I _{L3}	I	Current measurement I _{L3}
8	I _N	I	Current measurement I _N

I: Input



DANGER!

Please observe safety instructions!

With the energy measurement modules only AC voltages 230/400 V and currents can be measured. Please observe the safety instructions when handling an energy measuring module! ↪ Chap. 3.27.2 'Safety precautions' page 318

In-/Output area

At CPU, PROFIBUS and PROFINET the input respectively output area is embedded to the corresponding address area.

IX - Index for access via CANopen with s = Subindex, depends on number and type of analog modules

SX - Subindex for access via EtherCAT with Index 6000h + EtherCAT-Slot

More can be found in the according manual of your bus coupler.

Input area

Addr.	Name	Byte	Function	IX	SX
+0	B0 ... B3	4	Header byte 0 ... 3	6401h/s	01h
+4	D00 ... D11	12	User data input byte 0 ... 11	6401h/s+1	02h

Output area

Addr.	Name	Byte	Function	IX	SX
+0	B0 ... B3	4	Header byte 0 ... 3	6401h/s	01h
+4	D00 ... D11	12	User data output byte 0 ... 11	6401h/s+1	02h

↪ Chap. 3.27.7 'Process data communication' page 340

3.27.1 Technical data

3.27.1.1 031-1PA10

Order no.	031-1PA10
Type	SM 031
Module ID	0884 2880
Current consumption/power loss	
Current consumption from backplane bus	60 mA
Power loss	0.9 W
Rated load voltage	-
Status information, alarms, diagnostics	
Status display	yes
Interrupts	yes, parameterizable
Process alarm	no
Diagnostic interrupt	no
Diagnostic functions	yes, parameterizable
Diagnostics information read-out	possible
Module state	green LED
Module error display	red LED
Channel error display	-
Isolation	
Between channels	-
Insulation tested with	AC 2200 V
Energy measurement	
Number of channels for measuring	1* 1..3 phases U/I
Voltage measuring range	0..300 V each phase
Coupling voltage measurement	directly or transformer
Current range	0..5 A each phase
Coupling current measurement	Transformer
Frequency range	46...64 Hz
Measurement accuracy	1 %

Order no.	031-1PA10
Available measurement	Active energy Temperature Frequency Voltage RMS Current RMS Active power Reactive power Apparent power Cos phi Harmonic voltage RMS Harmonic current RMS
Adjustable limits	Voltage RMS min/max Current RMS min/max Cos phi min Temperature max. Frequency min/max
Datasizes	
Input bytes	16
Output bytes	16
Parameter bytes	30
Diagnostic bytes	20
Housing	
Material	PPE / PPE GF10
Mounting	Profile rail 35 mm
Mechanical data	
Dimensions (WxHxD)	12.9 mm x 109 mm x 76.5 mm
Net weight	57 g
Weight including accessories	57 g
Gross weight	71 g
Environmental conditions	
Operating temperature	0 °C to 60 °C
Storage temperature	-25 °C to 70 °C
Certifications	
UL certification	-
KC certification	-

The *Measurement accuracy* $\pm 1\%$ is maintained from:

Measurand	Measuring range
Voltage	230 V \pm 15%
Current	Current at measuring input ($I_{L1...L3} - I_N$) 0 ... 5A
Cos φ	Current at measuring input ($I_{L1...L3} - I_N$) \geq 100mA
Power	Current at measuring input ($I_{L1...L3} - I_N$) \geq 2mA
Active energy	Current at measuring input ($I_{L1...L3} - I_N$) \geq 2mA

3.27.1.2 031-1PA00

Order no.	031-1PA00
Type	SM 031
Module ID	0882 2880
Current consumption/power loss	
Current consumption from backplane bus	60 mA
Power loss	0.9 W
Rated load voltage	-
Status information, alarms, diagnostics	
Status display	yes
Interrupts	yes, parameterizable
Process alarm	no
Diagnostic interrupt	no
Diagnostic functions	yes, parameterizable
Diagnostics information read-out	possible
Module state	green LED
Module error display	red LED
Channel error display	-
Isolation	
Between channels	-
Insulation tested with	AC 2200 V
Energy measurement	
Number of channels for measuring	1* 1..3 phases U/I
Voltage measuring range	0..300 V each phase
Coupling voltage measurement	directly
Current range	0..1 A each phase
Coupling current measurement	Transformer
Frequency range	46...64 Hz
Measurement accuracy	1 %

Order no.	031-1PA00
Available measurement	Active energy Temperature Frequency Voltage RMS Current RMS Active power Reactive power Apparent power Cos phi Harmonic voltage RMS Harmonic current RMS
Adjustable limits	Voltage RMS min/max Current RMS min/max Cos phi min Temperature max. Frequency min/max
Datasizes	
Input bytes	16
Output bytes	16
Parameter bytes	28
Diagnostic bytes	20
Housing	
Material	PPE / PPE GF10
Mounting	Profile rail 35 mm
Mechanical data	
Dimensions (WxHxD)	12.9 mm x 109 mm x 76.5 mm
Net weight	57 g
Weight including accessories	57 g
Gross weight	71 g
Environmental conditions	
Operating temperature	0 °C to 60 °C
Storage temperature	-25 °C to 70 °C
Certifications	
UL certification	-
KC certification	-

The **Measurement accuracy $\pm 1\%$** is maintained from:

Measurand	Measuring range
Voltage	230 V \pm 15%
Current	Current at measuring input ($I_{L1...L3} - I_N$) 0 ... 1A
Cos φ	Current at measuring input ($I_{L1...L3} - I_N$) \geq 100mA
Power	Current at measuring input ($I_{L1...L3} - I_N$) \geq 2mA
Active energy	Current at measuring input ($I_{L1...L3} - I_N$) \geq 2mA

3.27.2 Safety precautions

Please note!

With the energy measurement modules only AC voltages 230/400V and currents can be measured. Please note when using an energy measurement module the following safety instructions:



DANGER!

No use in EX-zone permitted!

This device is not certified for applications in explosive environments (EX-zone)!



DANGER!

Do not exchange phase and neutral connections!

Operation of the energy measuring module with phase (L1, L2 or L3) at 'N' (pin 4) is not permitted!



DANGER!

Connection and module exchange only without power!

- Before you start to work on at the module for installation or maintenance, you have to disconnect it from the main power source, i.e. the power line is to be switched off (possibly remove fuses)!
- The electronic module may only be replaced on power off!
- Only properly qualified electrical staff is allowed to install, connect and/or modify electrical equipment!
- Please adhere to the national rules and regulations of the location and/or country where the units are installed (installation, safety precautions, EMC ...).



DANGER!

Provide overvoltage protection!

The module is designed for overvoltage category II. Provide a corresponding overvoltage protection in the supply lines (phases and neutral) so that a hazard to persons by touching on the low voltage side is excluded.

**DANGER!****Provide touch protection!**

Provide a touch protected wiring of the measurement including the measuring transformers and mark it with the according warnings!

**DANGER!****No use with System SLIO safety modules!**

The simultaneous use of energy measurement modules and System SLIO safety modules on the backplane bus is not permitted!

**DANGER!****Use only with terminal module 001-0AA40!**

Please consider that the electronic module of the energy measurement modules may only be used at the terminal module 001-0AA40!

**DANGER!****Line voltage max. 400V!**

The line voltage at a voltage connector must not exceed 400V!

**DANGER!****All phases of one supply grid!**

Please note that the phases to be measured must be from the same supply grid!

**CAUTION!****Do not exchange current and voltage connections!**

Please note when connecting, that the current and voltage paths are not exchanged! The module will be destroyed by directly connecting one phase to a low-resistance current connector!

**CAUTION!****Consider the maximum current for current transformers!**

Depending on the energy measuring module used, the following maximum current limits for the current transformers must be considered:

- 031-1PA00: max. 1A
- 031-1PA10: max. 5A

Please also consider the data sheet of your current transformer!

**CAUTION!****Note characteristics of current transformers!**

- Please consider the data sheet of your current transformer!
- Some current transformer must not be operated in idle mode!
- Before commissioning your module must be connected to the secondary winding of the current transformer!

**CAUTION!****Note characteristics of voltage transformers!**

- Please note that the use of a voltage transformer is only supported by the energy measurement module 031-1PA10!
- Please consider the data sheet and the safety instructions of your voltage transformer!

**Interruption of the DC 24V power section supply!**

When using energy measurement modules, the DC 24V power section supply of the further backplane bus is interrupted. By installing a power module after an energy measurement module, the DC 24V power section supply at the backplane bus can be continued.

**Reset energy counters after installation!**

As soon as the module is supplied by the DC 24V power section supply, the measurement is started and the counting of the energy counters is continued with the retentive stored counter values. The measurement is not interrupted by STOP or RESET of the CPU respectively the bus coupler. After installing the module the energy counters should be reset by CMD-Frame. ↪ Chap. 3.27.7.4.5 'CMD Frame' page 348



- *As long as no parameters have been sent from the head station to the module after a power cycle, default values are transmitted by the module during a read access and not the parameters stored in the module.*
- *After transferring the parameters to the module the status bits are reset and the measurement is interrupted for a short time!*
- *Please note when at least one phase is de-activated, the parameters PF_MIN and VRMS_MIN are ignored and set to "0".*
- *On error in the parametrization the MF LED blinks and you receive an error message. ↪ Chap. 3.27.7.2 'Status communication' page 341*

3.27.3 Basics

3.27.3.1 Terms

Measurand

A *measurand* is a physical quantity that can be measured such as current, voltage or temperature.

↪ *Chap. 3.27.6.1 'Measurands - 031-1PA10' page 331*

↪ *Chap. 3.27.6.2 'Measurands - 031-1PA00' page 335*

Measured value

A *measured value* is a value of a measurand, which is determined by measurement or by calculation.

ID

In the module each *measurand* one *ID* is assigned. The access to the measured value of a measurand happens by means of the corresponding *ID*.

DS-ID

As soon as the module is supplied by the DC 24V power section supply, the measurement is started and the counting of the energy counters is continued with the retentive stored counter values. The measured values of all the measurands are stored in the module with one record set *ID DS-ID*. The following must be observed:

- All measured values with the same *DS-ID* come from the same measurement and are consistent.
- By specifying the *DS-ID* you can address the individual measured values of the same measurement.
- The *DS-ID* covers the values 1 ... 15.
- To refresh the measured values the *DS-ID* is to be incremented by 1. The value 15 must be followed by 1.
- If the *DS-ID* is incremented and there is still no new value available, the current value is returned. Here the energy measurement module reports an error. ↪ *Chap. 3.27.7.2 'Status communication' page 341*
- *DS-ID* = 0 - Auto increment mode
 - With *DS-ID* = 0 there is a request with *auto increment mode*. Here the module always returns the current measured value. As soon as a new measured value is available, here the *DS-ID* is incremented by one within the values 1 ... 15. If there is no new measured value available, the *DS-ID* is not changed. Here the energy measurement module reports an error. ↪ *Chap. 3.27.7.2 'Status communication' page 341*
- The uniqueness of a measured value always consists of the *ID* of the measurand and the *DS-ID*.

Frame

In the module you can combine some measurands to one data package (Frame), which is transferred in one step. One data package consists of 12byte user data. Considering the data length of 12 bytes, you can define the content of a frame by specifying the *ID* of the measurands. Up to 256 frames may be configured (*Frame 0 ... Frame 255*). The following must be observed:

- The definition of *Frame 1* to *Frame 255* happens by the command *Set_Frame*.
↪ *Chap. 3.27.7.4.3 'Set Frame' page 344.*
- *Frame 0* with the corresponding measurands can exclusively be specified by the parametrization. ↪ *Chap. 3.27.5 'Parameter data' page 326*
- With telegram type *Zero Frame* the data package of *Frame 0* can be accessed. After the start-up of the module there are automatic *Zero Frame* requests as long as the process data communication comes from the head module. ↪ *Chap. 3.27.7.4.4 'Read Frame' page 346*

FR-ID When defining frames by means of 'Set Frame', via the *FR-ID* these are assigned to a number between 0 ... 255. By specifying the *FR-ID* you can request the corresponding frame.

Data type In the following the data types are listed, which are used in the module. The length is to be considered particularly by the definition of *Frames*.

Data type	Length in byte	Description
UINT_8	1	Integer 8bit
UINT_16	2	Integer 16bit
UINT_32	4	Integer 32bit
INT_8	1	Signed integer 8bit
INT_16	2	Signed integer 16bit
INT_32	4	Signed integer 32bit
FLOAT	4	32bit floating point IEEE 754

3.27.3.2 Principle of measurement

Calculation of the effective values of current and voltage

- For 3phase AC low-voltage networks the nominal voltage corresponds to the RMS voltage U_{RMS} e.g. $230V_{RMS}$ as star voltage between one of the three phase conductors (L1, L2 or L3) and the neutral conductor N.
- The module is used for detecting the current and voltage values and the energy values of all 3 phases. Here, the module measures the real effective value (True RMS) of voltages and currents.
- The sampling rate of the digitally processed measured values is 2.7 kHz. The time interval for the calculation of the actual values is 200 ms. This results in an evaluation window of the measured data of 540 measured values, which can be requested at any time.

Voltage measurement

Averaging

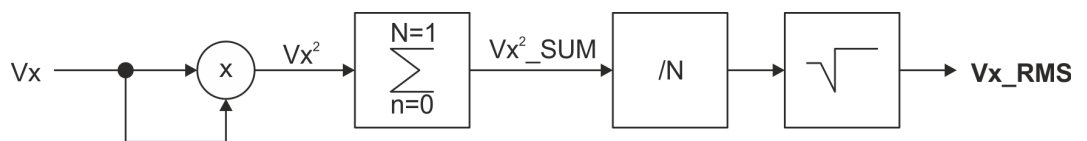

1. The square of the currently measured voltage V_x is calculated.
 $\Rightarrow V_x^2$
2. The sum of V_x^2 is calculated via the time interval $n = 0 \dots n = N-1$.
 $\Rightarrow V_x^2_SUM$
3. $V_x^2_SUM$ is divided by N the number of measurements.
4. From the result of the division, the square root is drawn.
 \Rightarrow **Average V_x_RMS**

Current measurement For current measurement you have to use external current transformers!

**CAUTION!****Consider the maximum current for current transformers!**

Depending on the energy measuring module used, the following maximum current limits for the current transformers must be considered:

- 031-1PA00: max. 1A
- 031-1PA10: max. 5A

Please also consider the data sheet of your current transformer!

**CAUTION!****Note characteristics of current transformers!**

- Please consider the data sheet of your current transformer!
- Some current transformer must not be operated in idle mode!
- Before commissioning your module must be connected to the secondary winding of the current transformer!



- *Please note that the overall accuracy of the assembly of measuring module and current transformers depends on the accuracy class of the transformers.*
- *The transformer factor is retentive stored and taken into account while counting.*
- *A change of the transformer factor is taken immediately recognized. Current counter values are not changed, new values are added.*
- *When the transformer factor was changed, current counter values are not changed, new values are added considering the new factor.*

Calculating power, energy

To calculate the effective power P, each time synchronous sample value of the currents and voltages are used. In this case, phase shifts between the currents and voltages are considered. The energy is calculated from integration of the power by time.



For the power is valid:

- *Positive sign (+): Consumed respectively received power*
- *Negative sign (-): Fed in power*

Determine frequency

The *frequency* of the phases is determined by a zero crossing detection of the sampled signals and calculating from the frequency.

Apparent power

$$S = U \times I$$

The *apparent power* S is calculated from the product of effective current I_{eff} and *effective voltage* U_{eff} . With the apparent power you get the total power of a power grid.

Reactive power

$$Q = U \times I \times \sin \varphi$$

With AC voltage supplied, any electrical device generates an electromagnetic field. By AC voltage, the magnetic field is regularly built and removed. Because the power to build a field is returned to the grid as it is being removed, this power is called "reactive power". Reactive power oscillates between consumer and producer generator and pollutes the power grids. The reactive power is the product of current and voltage at a reactance.

Reactances are all types of coils and capacitors. If these are connected to an AC voltage, they can absorb energy and release it phase-shifted as reactive power. The reactive power results of the phase-shift between current and voltage of the inductance respectively capacitance. With a pure ohmic resistance current and voltage are in the same phase, therefore, a purely resistive resistor has no reactive component.



The formula $Q = U \times I \times \sin \varphi$ applies only to purely sinusoidal currents.

Active power

$$P = U \times I \times \cos \varphi$$

The *active power* P is the effectively used power. This is the part without phase shift between voltage and current and refers to a resistive load.

Calculation of the power factor $\cos \varphi$ (phi)

In real networks energy consumers / producers typically are not purely ohmic. There is a phase shift between current and voltage. The $\cos \varphi$ is a measure of the phase shift between current and voltage of the basic frequency of the corresponding phase. The *total* $\cos \varphi$ is calculated by dividing *total active power* P and *total apparent power* S .

Harmonics

Harmonics are oscillations of the voltages and currents, whose frequency is an integer multiple of the basic frequency. The 1. harmonic is the basic frequency or mains frequency, nominally 50Hz or 60Hz. The level of harmonics is a measure for the network quality. Harmonics or harmonic oscillations are caused by equipment with non-linear characteristics such as transformers, fluorescent lamps and power electronic equipment such as rectifiers and thyristors. The non-sinus-shaped currents of these consumers cause the net interference voltages, which distorts the nominal line voltage. During parametrization you can specify the level of the harmonic. With this frequency the '*harmonic*' current and voltage values are filtered.

3.27.4 Connection



DANGER!

Please observe safety instructions!

With the energy measurement modules only AC voltages 230/400 V and currents can be measured. Please observe the safety instructions when handling an energy measuring module! ↪ *Chap. 3.27.2 'Safety precautions' page 318*

Connection via current transformer

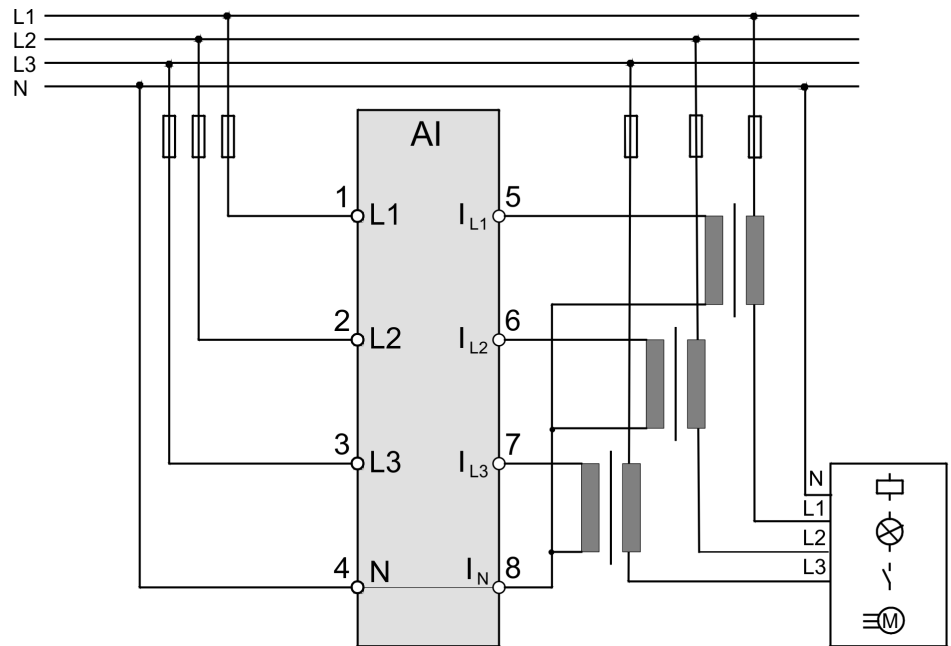
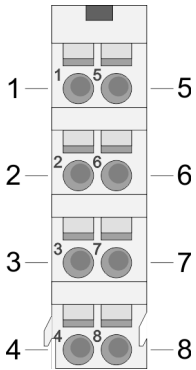

Connection via current- / voltage transformer

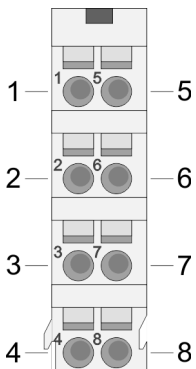

Please note that the use of a voltage transformer is only supported by the energy measurement module 031-1PA10!

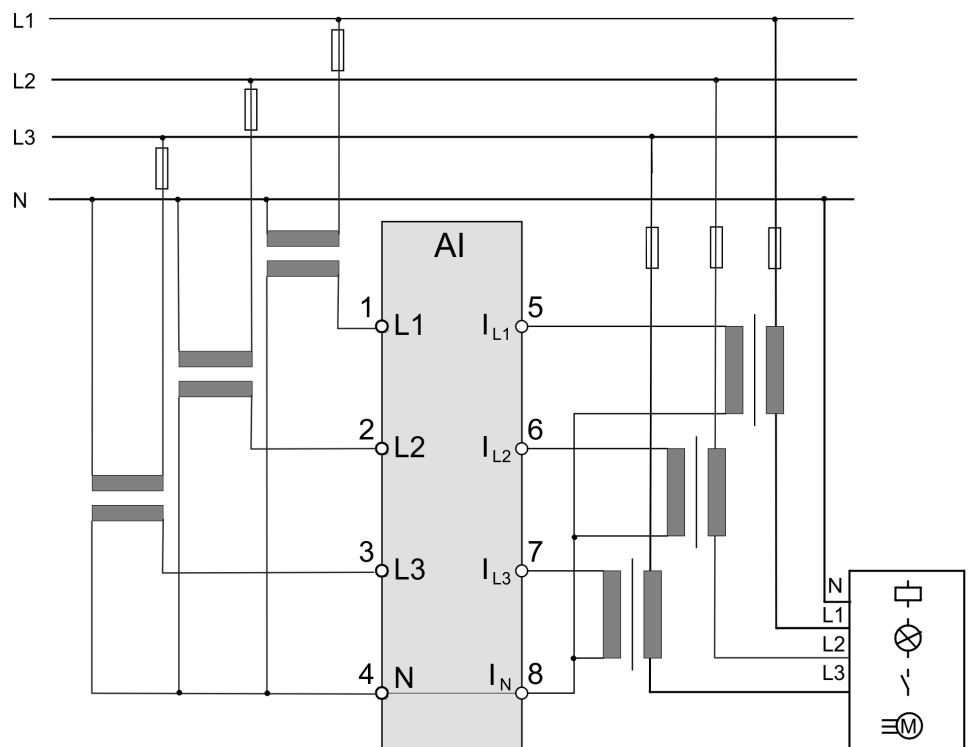

3.27.5 Parameter data

3.27.5.1 Parameter - 031-1PA10

DS - Record set for access via CPU, PROFIBUS and PROFINET

IX - Index for access via CANopen

SX - Subindex for access via EtherCAT with Index 3100h + EtherCAT-Slot

More can be found in the according manual of your bus coupler.

IDx	Name	Data type	Description	Default (dec.)	DS	IX	SX
1	CFG	UINT_8	Choice of phases and data formats	0	80h	3100h	01h
2	F0V1	UINT_8	Frame 0: Value 1 (IDx)	1	81h	3101h	02h
3	F0V2	UINT_8	Frame 0: Value 2 (IDx)	9		3102h	03h
4	F0V3	UINT_8	Frame 0: Value 3 (IDx)	13		3103h	04h
5	F0V4	UINT_8	Frame 0: Value 4 (IDx)	12		3104h	05h
6	F0V5	UINT_8	Frame 0: Value 5 (IDx)	0		3105h	06h
102	IRMS_MAX ¹	UINT_32	Current upper limit [mA] Range of values: 0 ... 25000000	0 ¹	82h	3106h.. 3109h	07h
104	VRMS_MAX	UINT_16	Voltage upper limit [V] Range of values: 0 ... 30000	260	83h	310Ah 310Bh	08h
105	VRMS_MIN	UINT_16	Voltage lower limit [V] Range of values: 0 ... 30000	200		310Ch.. 310Dh	09h
106	PF_MIN	UINT_8	Cos φ lower limit [0.01] Range of values: 0 ... 100	30	84h	310Eh..	0Ah
107	T_MAX	UINT_16	Temperature upper limit [0.01 °C] Range of values: 0 ... 20000	7000	85h	310Fh.. 3110h	0Bh
108	F_MAX	UINT_16	Frequency upper limit [0.01 Hz] Range of values: 0 ... 20000	5100		3111h.. 3112h	0Ch
109	F_MIN	UINT_16	Frequency lower limit [0.01 Hz] Range of values: 0 ... 20000	4900		3113h.. 3114h	0Dh
111	WANDLER_I	UINT_16	Current transformer factor Range of values: 1 ... 5000	1		3115h.. 3116h	0Eh
112	WANDLER_U	UINT_16	Voltage transformer factor Range of values: 1 ... 300	1	3117h.. 3118h	0Fh	
113	HARM	UINT_8	Harmonic number ↪ <i>'Harmonics'</i> <i>page 324</i> Range of values: 1 ... 30	1	86h	3119h	10h

The parameters are transferred in big-endian format (byte order: high byte, low byte).

1) Parameter is to be defined. (value: >0).



- As long as no parameters have been sent from the head station to the module after a power cycle, default values are transmitted by the module during a read access and not the parameters stored in the module.
- After transferring the parameters to the module the status bits are reset and the measurement is interrupted for a short time!
- Please note when at least one phase is de-activated, the parameters PF_MIN and VRMS_MIN are ignored and set to "0".
- On error in the parametrization the MF LED blinks and you receive an error message. ↪ Chap. 3.27.7.2 'Status communication' page 341

Data type

↪ 'Data type' page 322

CFG

Bit	Name	Description	Default
0	reserved		0
1	Write Protect ¹	Write protection bit for parameterization via Web server <ul style="list-style-type: none"> ■ 0: Write Protect de-activated ■ 1: Write Protect activated Please see the following note!	1 ¹
2	reserved		0
3	Phase 1	Measurement phase L1 <ul style="list-style-type: none"> ■ 0: Measurement is activated ■ 1: Measurement is de-activated 	0
4	Phase 2	Measurement phase L2 <ul style="list-style-type: none"> ■ 0: Measurement is activated ■ 1: Measurement is de-activated 	0
5	Phase 3	Measurement phase L3 <ul style="list-style-type: none"> ■ 0: Measurement is activated ■ 1: Measurement is de-activated 	0
6	Data type	Data type of the measured values in the user data <ul style="list-style-type: none"> ■ 0: Integer (INT) ■ 1: 32bit floating point (FLOAT) DIN IEEE 754 	0
7	Byteorder	Data type of the measured values in the user data <ul style="list-style-type: none"> ■ 0: Big-Endian: Byte order: high byte, low byte ■ 1: Little-Endian: Byte order: low byte, high byte 	0

1) Access to the 'Write Protect' parameter is only possible via the Web server of the head module (not via GSD or GSDML).

**¹⁾ Write Protect**

The parameter 'Write Protect' is only relevant, if the module is connected to a head module with an integrated Web server. If the module is parameterized via the Web server 'Write Protect' must be set to "0", otherwise the changed parameters will not be used!

F0V1 ... F0V5

In the module you can combine some measurands to one data package (Frame), which is transferred in one step. ↪ *'Frame' page 321*

By specifying the *ID* of the corresponding measurand, via *F0V1 ... F0V5* the data areas of Frame 0 can be defined. Please note that here the user data length of 12 bytes is not exceeded. ↪ *Chap. 3.27.6.1 'Measurands - 031-1PA10' page 331*

- Range of values: 0 ... 41
- Default:
 - F0V1: 1 (active energy consumer)
 - F0V2: 9 (total active power)
 - F0V3: 13 (total cos φ)
 - F0V4: 0
 - F0V5: 0

3.27.5.2 Parameter - 031-1PA00

DS - Record set for access via CPU, PROFIBUS and PROFINET

IX - Index for access via CANopen

SX - Subindex for access via EtherCAT with Index 3100h + EtherCAT-Slot

More can be found in the according manual of your bus coupler.

IDx	Name	Data type	Description	Default (dec.)	DS	IX	SX
1	CFG	UINT_8	Choice of phases and data formats	0	80h	3100h	01h
2	F0V1	UINT_8	Frame 0: Value 1 (IDx)	1	81h	3101h	02h
3	F0V2	UINT_8	Frame 0: Value 2 (IDx)	9		3102h	03h
4	F0V3	UINT_8	Frame 0: Value 3 (IDx)	13		3103h	04h
5	F0V4	UINT_8	Frame 0: Value 4 (IDx)	12		3104h	05h
6	F0V5	UINT_8	Frame 0: Value 5 (IDx)	0		3105h	06h
102	IRMS_MAX ¹	UINT_32	Current upper limit [mA] Range of values: 0 ... 25000000	0 ¹		82h	3106h.. 3109h
104	VRMS_MAX	UINT_16	Voltage upper limit [V] Range of values: 0 ... 500	260	83h	310Ah 310Bh	08h
105	VRMS_MIN	UINT_16	Voltage lower limit [V] Range of values: 0 ... 500	200		310Ch.. 310Dh	09h
106	PF_MIN	UINT_8	Cos φ lower limit [0.01] Range of values: 0 ... 100	30		84h	310Eh.. 0Ah
107	T_MAX	UINT_16	Temperature upper limit [0.01 °C] Range of values: 0 ... 20000	7000	85h	310Fh.. 3110h	0Bh
108	F_MAX	UINT_16	Frequency upper limit [0.01 Hz] Range of values: 0 ... 20000	5100		3111h.. 3112h	0Ch
109	F_MIN	UINT_16	Frequency lower limit [0.01 Hz] Range of values: 0 ... 20000	4900		3113h.. 3114h	0Dh

IDx	Name	Data type	Description	Default (dec.)	DS	IX	SX
111	WANDLER_I	UINT_16	Current transformer factor Range of values: 1 ... 5000	1		3115h.. 3116h	0Eh
112	HARM	UINT_8	Harmonic number ↗ <i>'Harmonics'</i> <i>page 324</i> Range of values: 1 ... 30	1	86h	3117h	0Fh

The parameters are transferred in big-endian format (byte order: high byte, low byte).

1) Parameter is to be defined. (value: >0).



- As long as no parameters have been sent from the head station to the module after a power cycle, default values are transmitted by the module during a read access and not the parameters stored in the module.
- After transferring the parameters to the module the status bits are reset and the measurement is interrupted for a short time!
- Please note when at least one phase is de-activated, the parameters PF_MIN and VRMS_MIN are ignored and set to "0".
- On error in the parametrization the MF LED blinks and you receive an error message. ↗ Chap. 3.27.7.2 *'Status communication'* page 341

Data type

↗ *'Data type'* page 322

CFG

Bit	Name	Description	Default
0	reserved		0
1	Write Protect ¹	Write protection bit for parameterization via Web server <ul style="list-style-type: none"> ■ 0: Write Protect de-activated ■ 1: Write Protect activated Please see the following note!	1 ¹
2	reserved		0
3	Phase 1	Measurement phase L1 <ul style="list-style-type: none"> ■ 0: Measurement is activated ■ 1: Measurement is de-activated 	1
4	Phase 2	Measurement phase L2 <ul style="list-style-type: none"> ■ 0: Measurement is activated ■ 1: Measurement is de-activated 	1
5	Phase 3	Measurement phase L3 <ul style="list-style-type: none"> ■ 0: Measurement is activated ■ 1: Measurement is de-activated 	1
6	Data type	Data type of the measured values in the user data <ul style="list-style-type: none"> ■ 0: Integer (INT) ■ 1: 32bit floating point (FLOAT) DIN IEEE 754 	0
7	Byteorder	Data type of the measured values in the user data <ul style="list-style-type: none"> ■ 0: Big-Endian: Byte order: high byte, low byte ■ 1: Little-Endian: Byte order: low byte, high byte 	0

1) Access to the 'Write Protect' parameter is only possible via the Web server of the head module (not via GSD or GSDML).



¹⁾ Write Protect

The parameter 'Write Protect' is only relevant, if the module is connected to a head module with an integrated Web server. If the module is parameterized via the Web server 'Write Protect' must be set to "0", otherwise the changed parameters will not be used!

F0V1 ... F0V5

In the module you can combine some measurands to one data package (Frame), which is transferred in one step. ↪ 'Frame' page 321

By specifying the *ID* of the corresponding measurand, via *F0V1 ... F0V5* the data areas of Frame 0 can be defined. Please note that here the user data length of 12 bytes is not exceeded. ↪ Chap. 3.27.6.2 'Measurands - 031-1PA00' page 335

- Range of values: 0 ... 41
- Default:
 - F0V1: 1 (active energy consumer)
 - F0V2: 9 (total active power)
 - F0V3: 13 (total cos φ)
 - F0V4: 0
 - F0V5: 0

3.27.6 Measurands

3.27.6.1 Measurands - 031-1PA10

Data type INT

ID	Description	Data type	Unit	Min. value	Max. value
1	Counter: Active energy consumer	UINT_32	1Wh ¹	0	4 294 967 295
2	Counter: Active energy producer	UINT_32	1Wh ¹	0	4 294 967 295
3	Counter: Active energy L1 consumer	UINT_32	1Wh ¹	0	4 294 967 295
4	Counter: Active energy L1 producer	UINT_32	1Wh ¹	0	4 294 967 295
5	Counter: Active energy L2 consumer	UINT_32	1Wh ¹	0	4 294 967 295
6	Counter: Active energy L2 producer	UINT_32	1Wh ¹	0	4 294 967 295
7	Counter: Active energy L3 consumer	UINT_32	1Wh ¹	0	4 294 967 295
8	Counter: Active energy L3 producer	UINT_32	1Wh ¹	0	4 294 967 295
9	Total active power	INT_32	1mW	-2 147 483 647	2 147 483 647
10	Total reactive power	INT_32	1mW	-2 147 483 647	2 147 483 647
11	Total apparent power	INT_32	1mW	-2 147 483 647	2 147 483 647
12	Frequency	UINT_16	0.01Hz	4600	6400
13	Total Cos φ^2	INT_8	0.01	-100	100
14	Temperature	INT_16	0.01°C	-2500	8500
15	Active power L1	INT_32	1mW	-715 827 882	715 827 882
16	Reactive power L1	INT_32	1mW	-715 827 882	715 827 882
17	Total power L1	INT_32	1mW	-715 827 882	715 827 882
18	Voltage L1	UINT_32	1mV	0	30 000 000
19	Current L1	UINT_32	1mA	0	25 000 000
20	Cos φ L1 ²	INT_8	0.01	-100	100
21	Harmonic voltage L1	UINT_32	1mV	0	30 000 000
22	Harmonic current L1	UINT_32	1mA	0	25 000 000
23	Active power L2	INT_32	1mW	-715 827 882	715 827 882
24	Reactive power L2	INT_32	1mW	-715 827 882	715 827 882
25	Total power L2	INT_32	1mW	-715 827 882	715 827 882
26	Voltage L2	UINT_32	1mV	0	30 000 000
27	Current L2	UINT_32	1mA	0	25 000 000
28	Cos φ L2 ²	INT_8	0.01	-100	100
29	Harmonic voltage L2	UINT_32	1mV	0	30 000 000
30	Harmonic current L2	UINT_32	1mA	0	25 000 000
31	Active power L3	INT_32	1mW	-715 827 882	715 827 882
32	Reactive power L3	INT_32	1mW	-715 827 882	715 827 882
33	Total power L3	INT_32	1mW	-715 827 882	715 827 882
34	Voltage L3	UINT_32	1mV	0	30 000 000
35	Current L3	UINT_32	1mA	0	25 000 000

031-1PAxx - AI1x 3Ph 230/400V > Measurands

ID	Description	Data type	Unit	Min. value	Max. value
36	Cos φ L3 ²	INT_8	0.01	-100	100
37	Harmonic voltage L3	UINT_32	1mV	0	30 000 000
38	Harmonic current L3	UINT_32	1mA	0	25 000 000
39	Overflow energy meter consumer Is incremented by 1 in case of overflow of the energy meter (ID = 1)	UINT_32		0	4 294 967 295
40	Overflow energy meter producer Is incremented by 1 in case of overflow of the energy meter (ID = 2)	UINT_32		0	4 294 967 295
41	Status bits ↪ 'Status bits' page 335	UINT_32			

1) The display resolution of the energy meter is $1\text{Wh} \times \text{WANDLER}_I \times \text{WANDLER}_U$ (current transformer factor x voltage transformer factor). [↪ Chap. 3.27.5.1 'Parameter - 031-1PA10' page 326](#)

2) The measuring accuracy of the Cos φ is maintained from a minimum current of $100\text{mA} \times \text{WANDLER}_I$ (current transformer factor).

ToleranceSee Technical data [↪ Chap. 3.27.1.1 '031-1PA10' page 313](#)**ID**Each measurand one *ID* is assigned. The access to the measured value of a measurand happens by means of the corresponding *ID*.**Data type**[↪ 'Data type' page 322](#)**Max. Total power**

- The max. Total power for 3 phases is
 - $\pm 2\,147\,483\,647\text{mW}$ (INT_32)
- $3 \times U_{\text{max}} \times \text{WANDLER}_U \times I_{\text{max}} \times \text{WANDLER}_I$

If the Total power is exceeded by $\pm 2\,147\,483\,647\text{mW}$ (INT_32), the max value is output.**Overflow energy meter**

- 0xXX112233
 - XX: not used
 - 11: Overflow phase L1
 - 22: Overflow phase L2
 - 33: Overflow phase L3

Measurands Data type FLOAT

ID	Description	Data type	Unit	Min. value	Max. value
1	Counter: Active energy consumer	FLOAT	1Wh ¹	0	5.497558×10^8
2	Counter: Active energy producer	FLOAT	1Wh ¹	0	5.497558×10^8
3	Counter: Active energy L1 consumer	FLOAT	1Wh ¹	0	5.497558×10^8
4	Counter: Active energy L1 producer	FLOAT	1Wh ¹	0	5.497558×10^8
5	Counter: Active energy L2 consumer	FLOAT	1Wh ¹	0	5.497558×10^8
6	Counter: Active energy L2 producer	FLOAT	1Wh ¹	0	5.497558×10^8
7	Counter: Active energy L3 consumer	FLOAT	1Wh ¹	0	5.497558×10^8

ID	Description	Data type	Unit	Min. value	Max. value
8	Counter: Active energy L3 producer	FLOAT	1Wh ¹	0	5.497558 x 10 ⁸
9	Total active power	FLOAT	1W	-2.147484 x 10 ⁶	2.147484 x 10 ⁶
10	Total reactive power	FLOAT	1W	-2.147484 x 10 ⁶	2.147484 x 10 ⁶
11	Total apparent power	FLOAT	1W	-2.147484 x 10 ⁶	2.147484 x 10 ⁶
12	Frequency	FLOAT	10Hz	4.600 x 10 ³	6.400 x 10 ³
13	Total Cos φ^2	FLOAT	10	-0.01	1.0
14	Temperature	FLOAT	10°C	-2.500 x 10 ³	8.500 x 10 ³
15	Active power L1	FLOAT	1W	-7.158278 x 10 ⁵	7.158278 x 10 ⁵
16	Reactive power L1	FLOAT	1W	-7.158278 x 10 ⁵	7.158278 x 10 ⁵
17	Total power L1	FLOAT	1W	-7.158278 x 10 ⁵	7.158278 x 10 ⁵
18	Voltage L1	FLOAT	1V	0	3.0 x 10 ⁴
19	Current L1	FLOAT	1A	0	2.5 x 10 ⁴
20	Cos φ L1 ²	FLOAT	10	-0.01	1.0
21	Harmonic voltage L1	FLOAT	1V	0	3.0 x 10 ⁴
22	Harmonic current L1	FLOAT	1A	0	2.5 x 10 ⁴
23	Active power L2	FLOAT	1W	-7.158278 x 10 ⁵	7.158278 x 10 ⁵
24	Reactive power L2	FLOAT	1W	-7.158278 x 10 ⁵	7.158278 x 10 ⁵
25	Total power L2	FLOAT	1W	-7.158278 x 10 ⁵	7.158278 x 10 ⁵
26	Voltage L2	FLOAT	1V	0	3.0 x 10 ⁴
27	Current L2	FLOAT	1A	0	2.5 x 10 ⁴
28	Cos φ L2 ²	FLOAT	10	-0.01	1.0
29	Harmonic voltage L2	FLOAT	1V	0	3.0 x 10 ⁴
30	Harmonic current L2	FLOAT	1A	0	2.5 x 10 ⁴
31	Active power L3	FLOAT	1W	-7.158278 x 10 ⁵	7.158278 x 10 ⁵
32	Reactive power L3	FLOAT	1W	-7.158278 x 10 ⁵	7.158278 x 10 ⁵
33	Total power L3	FLOAT	1W	-7.158278 x 10 ⁵	7.158278 x 10 ⁵
34	Voltage L3	FLOAT	1V	0	3.0 x 10 ⁴
35	Current L3	FLOAT	1A	0	2.5 x 10 ⁴
36	Cos φ L3 ²	FLOAT	10	-0.01	1.0
37	Harmonic voltage L3	FLOAT	1V	0	3.0 x 10 ⁴
38	Harmonic current L3	FLOAT	1A	0	2.5 x 10 ⁴
39	Overflow energy meter consumer Is incremented by 1 in case of overflow of the energy meter (ID = 1)	FLOAT		Overflow energy meter is at FLOAT not effective	
40	Overflow energy meter producer Is incremented by 1 in case of overflow of the energy meter (ID = 2)	FLOAT		Overflow energy meter is at FLOAT not effective	
41	Status bits  'Status bits' page 335	UINT_32			

031-1PAxx - AI1x 3Ph 230/400V > Measurands

ID	Description	Data type	Unit	Min. value	Max. value
1)	The display resolution of the energy meter is $1\text{Wh} \times \text{WANDLER_I} \times \text{WANDLER_U}$ (current transformer factor x voltage transformer factor). ↗ <i>Chap. 3.27.5.1 'Parameter - 031-1PA10' page 326</i>				
2)	The measuring accuracy of the $\text{Cos } \varphi$ is maintained from a minimum current of $100\text{mA} \times \text{WANDLER_I}$ (current transformer factor).				

ToleranceSee Technical data ↗ *Chap. 3.27.1.1 '031-1PA10' page 313***ID**Each measurand one *ID* is assigned. The access to the measured value of a measurand happens by means of the corresponding *ID*.**Data type**↗ *'Data type' page 322***Max. Total power**

- The max. Total power for 3 phases is
 - $\pm 2.147484 \times 10^6\text{W}$ (FLOAT)
- $3 * U_{\text{max}} * \text{WANDLER_U} * I_{\text{max}} * \text{WANDLER_I}$

If the Total power is exceeded by $\pm 2.147484 \times 10^6\text{W}$ (FLOAT), the max value is output.

Status bits

With *status bits* you get information about limit violations.

- The limit values can be defined via the parametrization. ↪ *Chap. 3.27.5.1 'Parameter - 031-1PA10' page 326*
- The *status bits* are refreshed together with the other measurement values, as soon as the *DS-ID* is incremented.
- Set bits of *status bits* remain set as long as they are acknowledged. ↪ *Chap. 3.27.7.4.5 'CMD Frame' page 348.*
 - By acknowledging the *status bits*, the corresponding LEDs for exceeding the limit value will be deleted again.
- Byte order: high byte, low byte (at big endian)

Byte	Description
0	0: de-activated, 1: activated <ul style="list-style-type: none"> ■ Bit 0: Voltage at phase L2 below limit value (L2: VRMS_MIN) ■ Bit 1: Voltage at phase L3 below limit value (L3: VRMS_MIN) ■ Bit 2: Voltage at phase L1 above limit value (L1: VRMS_MAX) ■ Bit 3: Voltage at phase L2 above limit value (L2: VRMS_MAX) ■ Bit 4: Voltage at phase L3 above limit value (L3: VRMS_MAX) ■ Bit 5: Temperature above limit value (T_MAX) ■ Bit 6: Frequency below limit value (F_MIN) ■ Bit 7: Frequency above limit value (F_MAX)
1	0: de-activated, 1: activated <ul style="list-style-type: none"> ■ Bit 0 <ul style="list-style-type: none"> – 0: deleted via CMD Frame (0x04) – 1: if there was a RESET of the module. This happens after PowerON. ■ Bit 1: Current at phase L1 above limit value (L1: IRMS_MAX) ■ Bit 2: Current at phase L2 above limit value (L2: IRMS_MAX) ■ Bit 3: Current at phase L3 above limit value (L3: IRMS_MAX) ■ Bit 4: Efficiency $\cos \varphi$ phase L1 below limit value (L1: PF_MIN) ■ Bit 5: Efficiency $\cos \varphi$ phase L2 below limit value (L2: PF_MIN) ■ Bit 6: Efficiency $\cos \varphi$ phase L3 below limit value (L3: PF_MIN) ■ Bit 7: Voltage at phase L1 below limit value (L1: VRMS_MIN)
2, 3	reserved

3.27.6.2 Measurands - 031-1PA00**Data type INT**

ID	Description	Data type	Unit	Min. value	Max. value
1	Counter: Active energy consumer	UINT_32	1Wh ¹	0	4 294 967 295
2	Counter: Active energy producer	UINT_32	1Wh ¹	0	4 294 967 295
3	Counter: Active energy L1 consumer	UINT_32	1Wh ¹	0	4 294 967 295
4	Counter: Active energy L1 producer	UINT_32	1Wh ¹	0	4 294 967 295
5	Counter: Active energy L2 consumer	UINT_32	1Wh ¹	0	4 294 967 295
6	Counter: Active energy L2 producer	UINT_32	1Wh ¹	0	4 294 967 295
7	Counter: Active energy L3 consumer	UINT_32	1Wh ¹	0	4 294 967 295
8	Counter: Active energy L3 producer	UINT_32	1Wh ¹	0	4 294 967 295

031-1PAxx - AI1x 3Ph 230/400V > Measurands

ID	Description	Data type	Unit	Min. value	Max. value
9	Total active power	INT_32	1mW	-3 750 000	3 750 000
10	Total reactive power	INT_32	1mW	-3 750 000	3 750 000
11	Total apparent power	INT_32	1mW	-3 750 000	3 750 000
12	Frequency	UINT_16	0.01Hz	4600	6400
13	Total Cos φ^2	INT_8	0.01	-100	100
14	Temperature	INT_16	0.01°C	-2500	8500
15	Active power L1	INT_32	1mW	-1 250 000	1 250 000
16	Reactive power L1	INT_32	1mW	-1 250 000	1 250 000
17	Total power L1	INT_32	1mW	-1 250 000	1 250 000
18	Voltage L1	UINT_32	1mV	0	300 000
19	Current L1	UINT_32	1mA	0	5 000 000
20	Cos φ L1 ²	INT_8	0.01	-100	100
21	Harmonic voltage L1	UINT_32	1mV	0	300 000
22	Harmonic current L1	UINT_32	1mA	0	5 000 000
23	Active power L2	INT_32	1mW	-1 250 000	1 250 000
24	Reactive power L2	INT_32	1mW	-1 250 000	1 250 000
25	Total power L2	INT_32	1mW	-1 250 000	1 250 000
26	Voltage L2	UINT_32	1mV	0	300 000
27	Current L2	UINT_32	1mA	0	5 000 000
28	Cos φ L2 ²	INT_8	0.01	-100	100
29	Harmonic voltage L2	UINT_32	1mV	0	300 000
30	Harmonic current L2	UINT_32	1mA	0	5 000 000
31	Active power L3	INT_32	1mW	-1 250 000	1 250 000
32	Reactive power L3	INT_32	1mW	-1 250 000	1 250 000
33	Total power L3	INT_32	1mW	-1 250 000	1 250 000
34	Voltage L3	UINT_32	1mV	0	300 000
35	Current L3	UINT_32	1mA	0	5 000 000
36	Cos φ L3 ²	INT_8	0.01	-100	100
37	Harmonic voltage L3	UINT_32	1mV	0	300 000
38	Harmonic current L3	UINT_32	1mA	0	5 000 000
39	Overflow energy meter Is incremented by 1 in case of overflow of the energy meter (ID = 1)	UINT_32		0	4 294 967 295
40	Overflow energy meter Is incremented by 1 in case of overflow of the energy meter (ID = 2)	UINT_32		0	4 294 967 295
41	Status bits  'Status bits' page 339	UINT_32			

1) The display resolution of the energy meter is 1Wh x WANDLER_I (current transformer factor).  Chap. 3.27.5.2 'Parameter - 031-1PA00' page 3282) The measuring accuracy of the Cos φ is maintained from a minimum current of 5mA x WANDLER_I (current transformer factor).

Tolerance	See Technical data ↗ <i>Chap. 3.27.1.2 '031-1PA00' page 316</i>
ID	Each measurand one <i>ID</i> is assigned. The access to the measured value of a measurand happens by means of the corresponding <i>ID</i> .
Data type	↗ <i>'Data type' page 322</i>
Max. Total power	<ul style="list-style-type: none"> ■ The max. Total power for 3 phases is <ul style="list-style-type: none"> – $\pm 75\,000\,000\,000\text{mW}$ ■ $3 * U_{\text{max}} * I_{\text{max}} * \text{WANDLER_I} = \text{e.g.: } 3 * 100\text{V} * 1\text{A} * 5000$ <p>If the Total power is exceeded by $\pm 75\,000\,000\,000\text{mW}$, the max value is output.</p>
Overflow energy meter	<ul style="list-style-type: none"> ■ 0xXX112233 <ul style="list-style-type: none"> – XX: not used – 11: Overflow phase L1 – 22: Overflow phase L2 – 33: Overflow phase L3

Measurands Data type FLOAT

ID	Description	Data type	Unit	Min. value	Max. value
1	Counter: Active energy consumer	FLOAT	1Wh ¹	0	5.497558×10^8
2	Counter: Active energy producer	FLOAT	1Wh ¹	0	5.497558×10^8
3	Counter: Active energy L1 consumer	FLOAT	1Wh ¹	0	5.497558×10^8
4	Counter: Active energy L1 producer	FLOAT	1Wh ¹	0	5.497558×10^8
5	Counter: Active energy L2 consumer	FLOAT	1Wh ¹	0	5.497558×10^8
6	Counter: Active energy L2 producer	FLOAT	1Wh ¹	0	5.497558×10^8
7	Counter: Active energy L3 consumer	FLOAT	1Wh ¹	0	5.497558×10^8
8	Counter: Active energy L3 producer	FLOAT	1Wh ¹	0	5.497558×10^8
9	Total active power	FLOAT	1W	-3.75×10^6	3.75×10^6
10	Total reactive power	FLOAT	1W	-3.75×10^6	3.75×10^6
11	Total apparent power	FLOAT	1W	-3.75×10^6	3.75×10^6
12	Frequency	FLOAT	10Hz	4.600×10^3	6.400×10^3
13	Total Cos φ^2	FLOAT	10	-0.01	1.0
14	Temperature	FLOAT	10°C	-2.500×10^3	8.500×10^3
15	Active power L1	FLOAT	1W	-1.25×10^6	1.25×10^6
16	Reactive power L1	FLOAT	1W	-1.25×10^6	1.25×10^6
17	Total power L1	FLOAT	1W	-1.25×10^6	1.25×10^6
18	Voltage L1	FLOAT	1V	0	3.0×10^4
19	Current L1	FLOAT	1A	0	2.5×10^4
20	Cos φ L1 ²	FLOAT	10	-0.01	1.0
21	Harmonic voltage L1	FLOAT	1V	0	3.0×10^4

031-1PAxx - AI1x 3Ph 230/400V > Measurands

ID	Description	Data type	Unit	Min. value	Max. value
22	Harmonic current L1	FLOAT	1A	0	2.5×10^4
23	Active power L2	FLOAT	1W	-1.25×10^6	1.25×10^6
24	Reactive power L2	FLOAT	1W	-1.25×10^6	1.25×10^6
25	Total power L2	FLOAT	1W	-1.25×10^6	1.25×10^6
26	Voltage L2	FLOAT	1V	0	3.0×10^4
27	Current L2	FLOAT	1A	0	2.5×10^4
28	$\text{Cos } \varphi \text{ L2}^2$	FLOAT	10	-0.01	1.0
29	Harmonic voltage L2	FLOAT	1V	0	3.0×10^4
30	Harmonic current L2	FLOAT	1A	0	2.5×10^4
31	Active power L3	FLOAT	1W	-1.25×10^6	1.25×10^6
32	Reactive power L3	FLOAT	1W	-1.25×10^6	1.25×10^6
33	Total power L3	FLOAT	1W	-1.25×10^6	1.25×10^6
34	Voltage L3	FLOAT	1V	0	3.0×10^4
35	Current L3	FLOAT	1A	0	2.5×10^4
36	$\text{Cos } \varphi \text{ L3}^2$	FLOAT	10	-0.01	1.0
37	Harmonic voltage L3	FLOAT	1V	0	3.0×10^4
38	Harmonic current L3	FLOAT	1A	0	2.5×10^4
39	Overflow energy meter consumer Is incremented by 1 in case of overflow of the energy meter (ID = 1)	FLOAT		Overflow energy meter is at FLOAT not effective	
40	Overflow energy meter producer Is incremented by 1 in case of overflow of the energy meter (ID = 2)	FLOAT		Overflow energy meter is at FLOAT not effective	
41	Status bits ↪ 'Status bits' page 339	UINT_32			

1) The display resolution of the energy meter is $1\text{Wh} \times \text{WANDLER_I}$ (current transformer factor). ↪ Chap. 3.27.5.2 'Parameter - 031-1PA00' page 328

2) The measuring accuracy of the $\text{Cos } \varphi$ is maintained from a minimum current of $100\text{mA} \times \text{WANDLER_I}$ (current transformer factor).

Tolerance

See Technical data ↪ Chap. 3.27.1.2 '031-1PA00' page 316

IDEach measurand one *ID* is assigned. The access to the measured value of a measurand happens by means of the corresponding *ID*.**Data type**

↪ 'Data type' page 322

Max. Total power

- The max. Total power for 3 phases is
 - $\pm 3.75 \times 10^6 \text{mW}$ (FLOAT)
- $3 * U_{\text{max}} * I_{\text{max}} * \text{WANDLER_I} = \text{e.g.: } 3 * 100\text{V} * 1\text{A} * 30$

If the Total power is exceeded by $\pm 3.75 \times 10^6 \text{mW}$ (FLOAT), the max value is output.

Status bits

With *status bits* you get information about limit violations.

- The limit values can be defined via the parametrization. ↪ *Chap. 3.27.5.2 'Parameter - 031-1PA00' page 328*
- The *status bits* are refreshed together with the other measurement values, as soon as the DS-ID is incremented.
- Set bits of *status bits* remain set as long as they are acknowledged by ↪ *Chap. 3.27.7.4.5 'CMD Frame' page 348*.
 - By acknowledging the *status bits*, the corresponding LEDs for exceeding the limit value will be deleted again.
- Byte order: high byte, low byte (big endian)

Byte	Description
0	0: de-activated, 1: activated <ul style="list-style-type: none"> ■ Bit 0: Voltage at phase L2 below limit value (L2: VRMS_MIN) ■ Bit 1: Voltage at phase L3 below limit value (L3: VRMS_MIN) ■ Bit 2: Voltage at phase L1 above limit value (L1: VRMS_MAX) ■ Bit 3: Voltage at phase L2 above limit value (L2: VRMS_MAX) ■ Bit 4: Voltage at phase L3 above limit value (L3: VRMS_MAX) ■ Bit 5: Temperature above limit value (T_MAX) ■ Bit 6: Frequency below limit value (F_MIN) ■ Bit 7: Frequency above limit value (F_MAX)
1	0: de-activated, 1: activated <ul style="list-style-type: none"> ■ Bit 0 <ul style="list-style-type: none"> – 0: deleted via CMD Frame (0x04) – 1: if there was a RESET of the module. This happens after PowerON. ■ Bit 1: Current at phase L1 above limit value (L1: IRMS_MAX) ■ Bit 2: Current at phase L2 above limit value (L2: IRMS_MAX) ■ Bit 3: Current at phase L3 above limit value (L3: IRMS_MAX) ■ Bit 4: Efficiency $\cos \varphi$ phase L1 below limit value (L1: PF_MIN) ■ Bit 5: Efficiency $\cos \varphi$ phase L2 below limit value (L2: PF_MIN) ■ Bit 6: Efficiency $\cos \varphi$ phase L3 below limit value (L3: PF_MIN) ■ Bit 7: Voltage at phase L1 below limit value (L1: VRMS_MIN)
2, 3	reserved

3.27.7 Process data communication

Overview

During runtime the communication with the module happens via telegrams in the process image. Here you have the following possibilities:

- Read measured value
- Define Frame with measurands
- Read Frame with measured values
- Send control command

3.27.7.1 Structure

Telegram

The communication takes place via the I/O area of the head module. The head module sends via the output area a request telegram to the module. This responds with the requested data within the input area of the head module. Depending on the used head module this may take several cycles to complete, until the data are received in the input area. To ensure the consistency of all measured values, which originate from the same measurement, are stored in the module under one *DS-ID*. ↪ *'DS-ID' page 321*

For input and output data the telegram has a length of 16byte and the following structure:

Byte	Function
B0	B0: Header byte 0 <ul style="list-style-type: none"> ■ Bit 3 ... 0: Status communication ↪ <i>Chap. 3.27.7.2 'Status communication' page 341</i> ■ Bit 6 ... 4: Telegram type ↪ <i>Chap. 3.27.7.4 'Telegram type' page 342</i> ■ Bit 7: 0 fix reserved
B1	B1: Header byte 1 <ul style="list-style-type: none"> ■ ID of the measurand (1 ... 41) <ul style="list-style-type: none"> – Each measurand one <i>ID</i> is assigned. The access to the measured value of a measurand happens by means of the corresponding <i>ID</i> ↪ <i>Chap. 3.27.6.1 'Measurands - 031-1PA10' page 331</i> ↪ <i>Chap. 3.27.6.2 'Measurands - 031-1PA00' page 335</i>
B2	B2: Header byte 2 <ul style="list-style-type: none"> ■ Bit 3 ... 0: Data set ID (<i>DS-ID</i>) of the measured value (1 ... 15) <ul style="list-style-type: none"> – The measured values of one measurement are accessible in the module via one <i>DS-ID</i>. ■ Bit 7 ... 4: Length of the user data (1 ... 12) <ul style="list-style-type: none"> – Depending on the telegram type, here up to 12 byte user data can be found.
B3	B3: Header byte 3 - <i>Common status</i> ↪ <i>Chap. 3.27.7.3 'Common status' page 341</i>
D00	D00 ... D11: User data
...	<ul style="list-style-type: none"> ■ User data for data to be sent and received
D11	Length of user data are specified from D00 ... D11: On error no user data are transferred i.e. the length of the user data is 0 and the module returns an error ID. Range of values: 0 ... 12

3.27.7.2 Status communication

Via the header byte (bit 3 ... 0) the status of the communication can be determined. On error no user data are transferred i.e. the length of the user data is 0. Please note that low error IDs are overridden by higher error IDs.

Status	Designation
0x00	OK (no error)
0x01	Error: Record set could not be refreshed
0x02	Error: <i>DS-ID</i>
0x03	Error: Telegram length
0x04	Error: <i>Frame</i> too big
0x05	Error: <i>Frame</i> not defined
0x06	Error: Measurand not available <ul style="list-style-type: none"> ■ ↪ Chap. 3.27.6.1 'Measurands - 031-1PA10' page 331 ■ ↪ Chap. 3.27.6.2 'Measurands - 031-1PA00' page 335
0x07	Error: ' <i>CMD Frame</i> ' - Command could not be executed
0x08	Error: ' <i>Set Frame</i> ' - Frame definition is not valid (Set Frame)
0x09	Error: Telegram type not available - invalid request
0x0A	Error: Parameter - the last parameter set was not valid
0x0E	External error - Please contact our support
0x0F	Internal error: Due to a temporary disturbance during the processing of the measurement data, they could not be refreshed. If this error occurs more often, please contact our hotline.

3.27.7.3 Common status

With this byte you get an overview of possible error messages:

- Bit 0: Frequency F_{MAX} exceeded
- Bit 1: Frequency F_{MIN} undershot
- Bit 2: Temperature T_{MAX} exceeded
- Bit 3: Voltage $VRMS_{MAX}$ exceeded
- Bit 4: Voltage $VRMS_{MIN}$ undershot
- Bit 5: Efficiency PF_{MIN} undershot
- Bit 6: Current $IRMS_{MAX}$ exceeded
- Bit 7: reserved

Detailed information about an error can be found in the *Status bits*:

- 031-1PA10 ↪ '*Status bits*' page 335
- 031-1PA00 ↪ '*Status bits*' page 339

3.27.7.4 Telegram type

By specifying the *Telegram type* the content of the responded data is defined. The following telegram types are available:

Type	Designation	Page
0x00	'Zero Frame': Accessing <i>Frame 0</i>	↪ 342
0x10	'Read Value': Read the measured value of a measurand	↪ 342
0x20	'Read Frame': Read a previously defined data package (Frame)	↪ 346
0x30	'Set Frame': Define the data areas of a data package (Frame)	↪ 344
0x40	'CMD Frame': Send a command	↪ 348
0x60 ¹	'Read Param': Read Parameter	↪ 351

1) This telegram type is not supported by the energy measurement module 031-1PA00.

3.27.7.4.1 Zero Frame

This telegram type is the same as the telegram type '*Read Frame*' ↪ *Chap. 3.27.7.4.4 'Read Frame' page 346* applied at *Frame 0*. After the start-up of the module there are automatic *Zero Frame* requests as long as the process data communication comes from the head module.

3.27.7.4.2 Read Value

With '*Read Value*' all the measured values can be requested.

Request

Byte	Value	Description
B0	0x10	<ul style="list-style-type: none"> ■ Bit 3 ... 0: Error code (not relevant) ■ Bit 6 ... 4: 001 Telegram type '<i>Read Value</i>' ■ Bit 7: 0 fix reserved
B1	...	■ <i>ID</i> of the measurand. ↪ ' <i>ID</i> ' page 321
B2	...	<ul style="list-style-type: none"> ■ Bit 7 ... 4: Length user data (0) ■ Bit 3 ... 0: Data set ID <i>DS-ID</i> of the measured value to be read. ↪ '<i>DS-ID</i>' page 321
B3	0x00	■ Common status (not relevant).
D00	-	■ User data (not relevant).
...		
D11		

Response

Byte	Value	Description
B0	0x10	<ul style="list-style-type: none"> ■ Bit 3 ... 0: Status communication ↗ <i>Chap. 3.27.7.2 'Status communication' page 341</i> ■ Bit 6 ... 4: 001 Telegram type 'Read Value' ■ Bit 7: 0 fix reserved
B1	...	■ <i>ID</i> of the measurand from the request.
B2	...	<ul style="list-style-type: none"> ■ Bit 7 ... 4: Length of the user data with measured values in byte. ■ Bit 3 ... 0: <i>DS-ID</i> of the measured value from the request, which was read.
B3	...	■ Common status ↗ <i>Chap. 3.27.7.3 'Common status' page 341</i>
D00	...	<ul style="list-style-type: none"> ■ User data with the requested measured value ■ depending on the parameterized data format <ul style="list-style-type: none"> – Byte order: high byte, low byte (big endian) – Byte order: low byte, high byte (little endian)
...		
D11		

Example 'Read Value'

In the example with *ID* = 14 the temperature of the module for *DS-ID* = 1 is requested.

Request

Byte	Value	Description
B0	0x10	Telegram type 'Read Value'.
B1	0x0E	<i>ID</i> of the measurand. ↗ ' <i>ID</i> ' page 321
B2	0x01	<i>DS-ID</i> of the measured value to be read (<i>DS-ID</i> = 1). ↗ ' <i>DS-ID</i> ' page 321
B3	0x00	Common status (not relevant).
D00	-	User data (not relevant).
...		
D11		

Response

Byte	Value	Description
B0	0x10	Telegram type 'Read value' from the request.
B1	0x0E	<i>ID</i> of the measurand from the request.
B2	0x21	<ul style="list-style-type: none"> Length of the user data here temperature 2 byte. <i>DS-ID</i> of the measured value from the request, which was read.
B3	0x00	Common status: OK ↗ <i>Chap. 3.27.7.3 'Common status' page 341</i>
D00	0x00	User data with the requested temperature e.g. 35°C.
D01	0x23	

3.27.7.4.3 Set Frame

Overview

In the module you can combine some measurands to one data package (Frame ↗ *'Frame' page 321*), which is transferred in one step. With *'Set Frame'* a Frame can be built.

Request

Byte	Value	Description
B0	0x30	<ul style="list-style-type: none"> ■ Bit 3 ... 0: Error code (not relevant) ■ Bit 6 ... 4: 011 Telegram type <i>'Set Frame'</i> ■ Bit 7: 0 fix reserved
B1	...	■ <i>FR-ID</i> of the Frame to be set. ↗ <i>'FR-ID' page 322</i>
B2	...	<ul style="list-style-type: none"> ■ Bit 7 ... 4: Length user data: 1 byte each measurand ■ Bit 3 ... 0: <i>DS-ID</i>
B3	0x00	■ Common status (not relevant).
D00	...	<ul style="list-style-type: none"> ■ 1byte each measurand regarding that the measured values do not exceed the total length of 12byte. Here, the format of the measured values is taken into account (depending on the parameterized data type: INT or FLOAT). ↗ <i>Chap. 3.27.6 'Measurands' page 331</i> ↗ <i>'Data type' page 322</i>
...		
D11		

Response

Byte	Value	Description
B0	0x30	<ul style="list-style-type: none"> ■ Bit 3 ... 0: Status communication ↗ <i>Chap. 3.27.7.2 'Status communication' page 341</i> ■ Bit 6 ... 4: 011 Telegram type <i>'Set Frame'</i> ■ Bit 7: 0 fix reserved
B1	...	■ <i>FR-ID</i> of the Frame from the request.
B2	...	<ul style="list-style-type: none"> ■ Bit 7 ... 4: Length of the user data (0). ■ Bit 3 ... 0: <i>DS-ID</i>
B3	...	■ Common status ↗ <i>Chap. 3.27.7.3 'Common status' page 341</i>
D00	...	■ User data (not relevant).
...		
D11		

Example 'Set Frame'

Here a Frame with *FR-ID* 0x01 is defined. The Frame contains the following measurands:

- ID: 03: Counter: Active energy L1 (consumer)
- ID: 13: total cos φ
- ID: 12: Frequency

Request

Byte	Value	Description
B0	0x30	Telegram type 'Set Frame'.
B1	0x01	<i>FR-ID</i> of the Frame to be read (<i>FR-ID</i> = 1). ↗ ' <i>FR-ID</i> ' page 322
B2	0x30	Bit 7 ... 4: Length user data (3). Bit 3 ... 0: data set ID <i>DS-ID</i> of the measurands (0).
B3	0x00	Common status (not relevant).
D00	0x03	User data with the ID of the measurands.
D01	0x0D	
D02	0x0C	
D03	-	
...		Remaining user data are not relevant.
D11		

Response

Byte	Value	Description
B0	0x30	Telegram type 'Set Frame' from the request.
B1	0x01	<i>FR-ID</i> of the Frame from the request.
B2	0x00	Bit 7 ... 4: Length of the user data (0). Bit 3 ... 0: data set ID <i>DS-ID</i> of the measurands (0).
B3	0x00	Common status: OK ↗ Chap. 3.27.7.3 'Common status' page 341
D00	-	User data (not relevant).
...	...	
D11	-	

3.27.7.4.4 Read Frame

Overview

In the module you can combine some measurands to one data package (Frame ↗ *'Frame'* page 321), which is transferred in one step.

With *'Read Frame'* a Frame can be requested.

Request

Byte	Value	Description
B0	0x20	<ul style="list-style-type: none"> ■ Bit 3 ... 0: Error code (not relevant) ■ Bit 6 ... 4: 010 Telegram type <i>'Read Frame'</i> ■ Bit 7: 0 fix reserved
B1	...	<ul style="list-style-type: none"> ■ <i>FR-ID</i> of the Frame to be read. ↗ <i>'FR-ID'</i> page 322
B2	0x00	<ul style="list-style-type: none"> ■ Bit 7 ... 4: Length of the user data is 0.
	...	<ul style="list-style-type: none"> ■ Bit 3 ... 0: <i>DS-ID</i> of the measured value to be read. ↗ <i>'DS-ID'</i> page 321
B3	0x00	<ul style="list-style-type: none"> ■ Common status (not relevant).
D00	-	<ul style="list-style-type: none"> ■ User data (not relevant).
...		
D11		

Response

Byte	Value	Description
B0	0x20	<ul style="list-style-type: none"> ■ Bit 3 ... 0: Status communication ↗ <i>Chap. 3.27.7.2 'Status communication'</i> page 341 ■ Bit 6 ... 4: 010 Telegram type <i>'Read Frame'</i> ■ Bit 7: 0 fix reserved
B1	...	<ul style="list-style-type: none"> ■ <i>FR-ID</i> of the Frame from the request.
B2	...	<ul style="list-style-type: none"> ■ Bit 7 ... 4: Length of the user data with measured values in byte
	...	<ul style="list-style-type: none"> ■ Bit 3 ... 0: <i>DS-ID</i> of the measured value from the request, which was read.
B3	...	<ul style="list-style-type: none"> ■ Common status ↗ <i>Chap. 3.27.7.3 'Common status'</i> page 341
D00	...	<ul style="list-style-type: none"> ■ User data with the requested Frame with measured values. <ul style="list-style-type: none"> – Depending on the parameterized data format.
...		
D11		

Example 'Read Frame'

In the example the previously via 'Set Frame' defined *FR-ID* (0x01) is requested with the following measurands:

- ID: 03: Counter: Active energy L1 (consumer): 4byte
- ID: 13: total cos φ : 1byte
- ID: 12: Frequency 2byte

Request

Byte	Value	Description
B0	0x20	Telegram type 'Read Frame'
B1	0x01	<i>FR-ID</i> of the Frame to be read (<i>FR-ID</i> = 1). ↪ 'FR-ID' page 322
B2	0x01	Bit 7 ... 4: Length of the user data (0). Bit 3 ... 0: <i>DS-ID</i> of the measured value to be read (<i>DS-ID</i> = 1). ↪ 'DS-ID' page 321
B3	0x00	Common status (not relevant).
D00	-	User data (not relevant).
...		
D11		

Response

Byte	Value	Description
B0	0x20	Telegram type 'Read value' from the request.
B1	0x01	<i>FR-ID</i> of the Frame from the request
B2	0x71	Bit 7 ... 4: Length of the Frame with measured values (7) Bit 3 ... 0: <i>DS-ID</i> of the measured value from the request (1).
B3	0x00	Common status: OK ↪ Chap. 3.27.7.3 'Common status' page 341
D00	0x00	Counter: Active energy L1 (consumer): 500kWh
D01	0x07	
D02	0xA1	
D03	0x20	
D04	0x5A	Total cos φ : 0.9
D05	0x13	Frequency: 50Hz
D06	0x88	
D07	-	Remaining user data are not relevant.
...		
D11		

3.27.7.4.5 CMD Frame

With 'CMD Frame' you can send control commands to the module. This can trigger various actions or be used for reading and writing of control registers. The following control commands are available:

- Reset the energy counter
- Reset the status bits
- Request the firmware version
- Write counter values
- Read holding register (not 031-1PA00)
- Write counter values respectively set the active energy meters L1 - L3 (not 031-1PA00)

Request

Byte	Value	Description
B0	0x40	<ul style="list-style-type: none"> ■ Bit 3 ... 0: Error code (not relevant) ■ Bit 6 ... 4: 100 Telegram type 'CMD Frame' ■ Bit 7: reserved
B1	...	<ul style="list-style-type: none"> ■ <i>CMD-ID</i> of the control command, which is to be executed: <ul style="list-style-type: none"> – 0x01: Reset of all energy counters – 0x03: Reset the status bits – 0x04: Request the firmware version – 0x06¹: Read holding register – 0x07¹: Write in active energy meter
B2	...	<ul style="list-style-type: none"> ■ Bit 7 ... 4: Length of the user data depending on <i>CMD-ID</i>: <ul style="list-style-type: none"> – 0x01: Reset of all energy counters (length user data: 0byte) – 0x03: Reset the status bits (length user data: 4byte) – 0x04: Request the firmware version (length user data: 0byte) – 0x06¹: Read holding register (length user data: 0byte) – 0x07¹: Write in active energy meter (length user data: 6byte)
	...	<ul style="list-style-type: none"> ■ Bit 3 ... 0: Data set ID <i>DS-ID</i> of the measured value (3 ... 7).
B3	0x00	<ul style="list-style-type: none"> ■ Common status (not relevant).
D00	-	<ul style="list-style-type: none"> ■ User data depending on <i>CMD-ID</i> <ul style="list-style-type: none"> – 0x01: Reset of all energy counters (user data: not relevant) – 0x03: Reset the status bits (user data: 4byte with the corresponding set bits) – 0x04: Request the firmware version (user data: not relevant) – 0x06¹: Read holding register (user data: not relevant) – 0x07¹: Write in active energy meter
...		
D11		

1) This is not supported by the energy measurement module 031-1PA00.

Response

Byte	Value	Description
B0	0x40	<ul style="list-style-type: none"> ■ Bit 3 ... 0: Status communication ↗ <i>Chap. 3.27.7.2 'Status communication' page 341</i> ■ Bit 6 ... 4: 100 Telegram type 'CMD Frame' ■ Bit 7: 0 fix reserved
B1	...	<ul style="list-style-type: none"> ■ <i>CMD-ID</i> from the request.
B2	...	<ul style="list-style-type: none"> ■ Bit 7 ... 4: Length of the user data depending on <i>CMD-ID</i>: <ul style="list-style-type: none"> – 0x01: Reset of all energy counters (length user data: 0byte) – 0x03: Reset the status bits: (length user data: 4byte) – 0x04: Request the firmware version (Length user data: 10byte) – 0x06¹: Read holding register – 0x07¹: Write in active energy meter ■ Bit 3 ... 0: <i>DS-ID</i> (not relevant)
B3	...	<ul style="list-style-type: none"> ■ Common status ↗ <i>Chap. 3.27.7.3 'Common status' page 341</i>
D00	...	<ul style="list-style-type: none"> ■ User data depending on <i>CMD-ID</i>: <ul style="list-style-type: none"> – 0x01: Reset of all energy counters (user data: nothing) – 0x03: Reset the status bits: (User data: 4byte with the corresponding set bits) – 0x04: Request the firmware version (user data: 10byte with the version information) – 0x06¹: Read holding register – 0x07¹: Write in active energy meter ■ <i>ID</i> (1byte) of the measured value (<i>ID</i> 3 ... 8) ■ Overflow counter (1byte) ■ New value (4byte) ■ Byte order: high byte, low byte (big endian) ■ Byte order: low byte, high byte (little endian)
...		
D11		

1) This is not supported by the energy measurement module 031-1PA00.

Firmware version

- Byte 2... 0: Firmware version
- Byte 5 ... 3: Protocol version
 - Byte 3: Major
 - Byte 4: Minor
 - Byte 5: Revision
- Byte 9 ... 6: Measuring chip version
 - Byte 6: Day
 - Byte 7: Month
 - Byte 8: Year (hundreds)
 - Byte 9: Year (one)

Write in active energy meter (not 031-1PA00)

- Setting active energy meters L1 - L3 (consumers, producers)
- Byte 0: ID of the measured value to be written (*ID*: 3 ... 8).
 - Byte 1: Overflow counter
 - Byte 5 ... 2: New measured value

Example 'CMD Frame' In this example all the status bits are reset.

Request

Byte	Value	Description
B0	0x40	Telegram type 'CMD Frame'
B1	0x03	CMD-ID: Reset the status bits
B2	0x40	Reset the status bits: (length user data: 4byte)
B3	0x00	Common status (not relevant).
D00	0xFF	User data: Reset the status bits
D01	0xFF	
D02	0xFF	
D03	0xFF	

Response

Byte	Value	Description
B0	0x40	Telegram type 'CMD Frame' from the request.
B1	0x03	CMD-ID from the request.
B2	0x40	Length of the user data from the request.
B3	0x00	Common status: OK ↪ <i>Chap. 3.27.7.3 'Common status' page 341</i>
D00	0xFF	User data from the request.
D01	0xFF	
D02	0xFF	
D03	0xFF	

3.27.7.4.6 Read Param



This telegram type is not supported by the energy measurement module 031-1PA00.

With 'Read Param' (0x60) the parameters can be read via the process image.

Request

Byte	Value	Description
B0	0x60	<ul style="list-style-type: none"> Bit 3 ... 0: Error code (not relevant) Bit 6 ... 4: 110 Telegram type 'Read Param' Bit 7: reserved
B1	...	<ul style="list-style-type: none"> IDx of the parameter to be read. ↪ Chap. 3.27.5 'Parameter data' page 326
B2	...	<ul style="list-style-type: none"> Bit 7 ... 4: Length user data (0) Bit 3 ... 0: Data set ID <i>DS-ID</i> (relevant for one time reading).
B3	...	<ul style="list-style-type: none"> Common status (not relevant).
D00	...	<ul style="list-style-type: none"> User data (not relevant).
...		
D11		

Response

Byte	Value	Description
B0	0x60	<ul style="list-style-type: none"> Bit 3 ... 0: Status communication ↪ Chap. 3.27.7.2 'Status communication' page 341 Bit 6 ... 4: 110 Telegram type 'Read Param' Bit 7: reserved
B1	...	<ul style="list-style-type: none"> IDx of the read parameter.
B2	...	<ul style="list-style-type: none"> Bit 7 ... 4: Length of the user data (0) Bit 3 ... 0: Data set ID <i>DS-ID</i>
B3	...	<ul style="list-style-type: none"> Common status ↪ Chap. 3.27.7.3 'Common status' page 341
D00	...	<ul style="list-style-type: none"> Parameter value that was read.
...		
D11		

3.27.7.5 Example

Communication

Here the communication and the query of the status bits ($ID = 41$) are described on an example.

No.	Request	Response	Description
1	0x10 0x01 0x03 0x00		An ID and $DS-ID$ is requested: e.g.: M 1-3 M (ID)-($DS-ID$)
3		0x10 0x01 0x43 0x01 (4 byte data)	M 1-3 indicates frequency exceeded.
4	0x10 0x29 0x03 0x00		Query the status bits M 41-3.
5		0x10 0x29 0x43 0x05 0x00 0x00 0x80 0x00	Frequency exceeded and temperature exceeded is reported.
6	0x10 0x29 0x04 0x00		Query the status bits M 41-4.
7		0x10 0x29 0x44 0x05 0x00 0x00 0xA0 0x00	The status bit were refreshed ($ID = 41$) and temperature exceeded is reported.
8	0x40 0x03 0x45 0x00 0x00 0x00 0xA0 0x00		Reset the status bits (frequency exceeded and temperature exceeded).
9		0x40 0x03 0x45 0x00 0x00 0x00 0xA0 0x00	Status bits have been reset.
10	0x10 0x29 0x05 0x00		Query the status bits M 41-5.
11		0x10 0x29 0x45 0x00 0x00 0x00 0x20 0x00	Status bits have been reset. Temperature exceeded is reported.

3.27.8 Error messages and diagnostics

3.27.8.1 Status and error messages

Common status ↪ *Chap. 3.27.7.3 'Common status' page 341*

Status communication ↪ *Chap. 3.27.7.2 'Status communication' page 341*

Status bits

- 053-1PA10 ↪ *'Status bits' page 335*
- 053-1PA00 ↪ *'Status bits' page 339*

3.27.8.2 Diagnostic data

This module does not support diagnostic interrupt functions, the diagnostics data serve for information about this module. On error the corresponding channel LED of the module is activated and the error is registered in the diagnostics data.

The following errors are listed in the diagnostics data:

- Error in configuration / parametrization

DS - Record set for access via CPU, PROFIBUS and PROFINET. The access happens by DS 01h. Additionally the first 4 bytes may be accessed by DS 00h.

IX - Index for access via CANopen. The access happens by IX 2F01h. Additionally the first 4 bytes may be accessed by IX 2F00h.

SX - Subindex for access via EtherCAT with Index 5005h.

More can be found in the according manual of your bus coupler.

Name	Bytes	Function	Default	DS	IX	SX
ERR_A	1	Diagnostic	00h	01h	2F01h	02h
MODTYP	1	Module information	15h			03h
ERR_C	1	reserved	00h			04h
ERR_D	1	Diagnostic	00h			05h
CHTYP	1	Channel type	71h			06h
NUMBIT	1	Number diagnostic bits per channel	08h			07h
NUMCH	1	Number of channels of a module	03h			08h
CHERR	1	Channel error	00h			09h
CH0ERR	1	Channel-specific error channel 0	00h			0Ah
CH1ERR	1	Channel-specific error channel 1	00h			0Bh
CH2ERR	1	Channel-specific error channel 2	00h			0Ch
CH3ERR... CH7ERR	5	reserved	00h			0Dh ... 11h
DIAG_US	4	µs ticker	00h			13h

ERR_A Diagnostic

Byte	Bit 7 ... 0
0	<ul style="list-style-type: none"> ■ Bit 0: set at module failure ■ Bit 1: set at internal error ■ Bit 2: set at external error ■ Bit 3: set at channel error ■ Bit 4: set at external auxiliary supply missing ■ Bit 6 ... 5: reserved ■ Bit 7: set at error in parameterization

MODTYP Module information

Byte	Bit 7 ... 0
0	<ul style="list-style-type: none"> ■ Bit 3 ... 0: module class <ul style="list-style-type: none"> – 0101b analog module ■ Bit 4: set at channel information present ■ Bit 7 ... 5: reserved

ERR_D Diagnostic

Byte	Bit 7 ... 0
0	<ul style="list-style-type: none"> ■ Bit 2 ... 0: reserved ■ Bit 3: set at internal diagnostics buffer overflow ■ Bit 4: set at internal communication error ■ Bit 7 ... 5: reserved

CHTYP Channel type

Byte	Bit 7 ... 0
0	<ul style="list-style-type: none"> ■ Bit 6 ... 0: Channel type <ul style="list-style-type: none"> – 70h: Digital input – 71h: Analog input – 72h: Digital output – 73h: Analog output – 74h: Analog input/output – 76h: Counter ■ Bit 7: reserved

NUMBIT Diagnostic bits

Byte	Bit 7 ... 0
0	Number of diagnostic bits per channel (here 08h)

NUMCH Channels

Byte	Bit 7 ... 0
0	Number of channels of the module (here 03h)

CHERR Channel error

Byte	Bit 7 ... 0
0	<ul style="list-style-type: none"> ■ Bit 0: set at error in channel 0 ■ Bit 1: set at error in channel 1 ■ Bit 2: set at error in channel 2 ■ Bit 7 ... 3: reserved

CHxERR Channel-specific

Byte	Bit 7 ... 0
0	Channel-specific error channel x <ul style="list-style-type: none"> ■ Bit 0: set at configuration / parametrization error ■ Bit 7 ... 1: reserved

CH3ERR ... CH7ERR reserved

Byte	Bit 7 ... 0
0	reserved

DIAG_US μ s ticker

Byte	Bit 7 ... 0
0...3	Value of the μ s ticker at the moment of the diagnostic

 μ s ticker

In the System SLIO module there is a timer (μ s ticker). With PowerON the timer starts counting with 0. After $2^{32}-1\mu$ s the timer starts with 0 again.

3.27.9 VIPA handling block

The VIPA specific blocks can be found in the service area of www.vipa.com as library download file at Downloads > VIPA LIB 'Device Specific - SW90LS0MA'. The library is available as packed zip file. As soon as you want to use VIPA specific blocks you have to import them into your project. More information can be found in the manual for your block library. The following blocks are used for communication:

Blocks	Symbol	Description
UDT 325	EM_DATA_R1	Data structure for FB 325
FB 325	EM_COM_R1	Communication with 031-1PAxx for energy metering



More information about the usage of these blocks can be found in the manual "Device Specific - SW90LS0MA" at www.vipa.com in the "Service/Support" area at 'Manuals → VIPA Lib'.

Functionality

- The energy measuring module is used to measure the energy of a 3-phase connection. In addition to voltage, current and phase, the module determines many other measurands. [↪ Chap. 3.27.6 'Measurands' page 331](#)
- Limit values can be parametrized for some measurands. When exceeding or falling below corresponding interrupt status bits are set. The module supports several commands (CMD). For example, interrupt status bits can be reset hereby.
- With the function block FB 325 and the associated data structure of type UDT 325, you can read energy measured values and interrupt status bits of the energy measurement module and commands can be executed on the module. In this case, the FB 325 communicates via the cyclic I/O data (16 bytes each) of the module, which must be specified accordingly when FB 325 is called.
- The real request interface is realized via the data structure of the type UDT 325. As a result, a simple control and evaluation, for example via a touch panel is possible.

4 Analog Output

4.1 General

Cabling for analog signals

You must only use screened cable when you are connecting analog signals. These cables reduce the effect of electrical interference. The screen of the analog signal cable should be grounded at both ends. In situations with different electrical potentials, it is possible that a current will flow to equalize the potential difference. This current could interfere with the analog signals. Under these circumstances it is advisable to ground the screen of the signal cable at one end only.

Connecting loads and actuators

You can use the analog output modules to supply loads and actuators with current or voltage.



Please take always care of the correct polarity when connecting actuators! Please leave the output clamps of not used channels disconnected and set the output type of the channel to "deactivated" in the hardware configurator from Siemens.

Parameterization

The parameterization via CPU, PROFIBUS and PROFINET happens by means of record sets (DS). The corresponding record set number may be found at the respective module description. Here also the indices (IX) respectively subindices (SX) for CANopen respectively EtherCAT are listed.

Diagnostic functions

The modules have diagnostics capability. The following errors may release a diagnostic:

- Error in parameterization
- Short-circuit recognition
- Wire-break recognition



Alternated blinking of the channel error LEDs

The alternate blinking of the channel error LEDs of channel 0 and 1 indicates a watchdog error due to a system overload. Restart with a power cycle your system. If the error occurred again, check configuration and circuit and adjust them if necessary. If the error persists, please contact our support.

4.2 Analog value

Analog value representation

The analog values are only processed in binary representation. Hereby the binary word variable is transformed into an analog process signal and put out via the corresponding channel. The analog values are displayed as a fixed-point number in the two's complement.

Resolution	Analog value															
	High byte (byte 0)								Low byte (byte 1)							
Bit number	15	14	13	12	11	10	9	8	7	6	5	4	3	2	1	0
Resolution	SG	2 ¹⁴	2 ¹³	2 ¹²	2 ¹¹	2 ¹⁰	2 ⁹	2 ⁸	2 ⁷	2 ⁶	2 ⁵	2 ⁴	2 ³	2 ²	2 ¹	2 ⁰
12Bit	SG	Analog value (word)												X	X	X
15Bit	SG	Analog value (word)														

Resolution With a resolution of 12bit plus sign bit, the least significant bits (3bit) are not relevant.

Sign bit (SG) The algebraic sign bit is represented by Bit 15. Here it is essential:

- Bit 15 = "0": → positive value
- Bit 15 = "1": → negative value

4.3 Output ranges and function numbers

General In the following there are the output ranges listed with function number, which were supported by the corresponding analog module. The here listed formulas allow you to transform a value (digital value) to an analog value and vice versa.

Output ranges Voltage

0 ... 10V

Output range (funct. no.)	Voltage (U)	Decimal (D)	Hex	Range	Formulas
0 ... 10V Siemens S7 format (10h)	11,76V	32511	7EFFh	overrange	$U = D \times \frac{10}{27648}$ $D = 27648 \times \frac{U}{10}$
	10V	27648	6C00h	nominal range	
	5V	13824	3600h		
	0V	0	0000h		
	Not possible, is limited to 0V.				
0 ... 10V Siemens S5 format (20h)	12,5V	20480	5000h	overrange	$U = D \times \frac{10}{16384}$ $D = 16384 \times \frac{U}{10}$
	10V	16384	4000h	nominal range	
	5V	8192	2000h		
	0V	0	0000h		
	Not possible, is limited to 0V.				

±10V

Output range (funct. no.)	Voltage (U)	Decimal (D)	Hex	Range	Formulas
±10V Siemens S format (12h)	11.76V	32511	7EFFh	overrange	$U = D \times \frac{10}{27648}$ $D = 27648 \times \frac{U}{10}$
	10V	27648	6C00h	nominal range	
	5V	13824	3600h		
	0V	0	0000h		
	-5V	-13824	CA00h		
	-10V	-27648	9400h	underrange	
	-11.76V	-32512	8100h		
±10V Siemens S5 format (22h)	12.5V	20480	5000h	overrange	$U = D \times \frac{10}{16384}$ $D = 16384 \times \frac{U}{10}$
	10V	16384	4000h	nominal range	
	5V	8192	2000h		
	0V	0	0000h		
	-5V	-8192	E000h		
	-10V	-16384	C000h	underrange	
	-12.5V	-20480	B000h		

Output ranges

Current

0 ... 20mA

Output range (funct. no.)	Current (I)	Decimal (D)	Hex	Range	Formulas
0 ... 20mA Siemens S7 format (31h)	23.52mA	32511	7EFFh	overrange	$I = D \times \frac{20}{27648}$ $D = 27648 \times \frac{I}{20}$
	20mA	27648	6C00h	nominal range	
	10mA	13824	3600h		
	0mA	0	0000h		
	Not possible, is limited to 0mA.				
0 ... 20mA Siemens S5 format (41h)	25.00mA	20480	5000h	overrange	$I = D \times \frac{20}{16384}$ $D = 16384 \times \frac{I}{20}$
	20mA	16384	4000h	nominal range	
	10mA	8192	2000h		
	0mA	0	0000h		
	Not possible, is limited to 0mA.				

Output ranges and function numbers

4 ... 20mA

Output range (funct. no.)	Current (I)	Decimal (D)	Hex	Range	Formulas
4 ... 20mA Siemens S7 format (30h)	22.81mA	32511	7EFFh	overrange	$I = D \times \frac{16}{27648} + 4$ $D = 27648 \times \frac{I-4}{16}$
	20mA	27648	6C00h	nominal range	
	12mA	13824	3600h		
	4mA	0	0000h		
	0mA	-6912	E500h	underrange	
4 ... 20mA Siemens S5 format (40h)	24.00mA	20480	5000h	overrange	$I = D \times \frac{16}{16384} + 4$ $D = 16384 \times \frac{I-4}{16}$
	20mA	16384	4000h	nominal range	
	12mA	8192	2000h		
	4mA	0	0000h		
	0mA	-4096	F000h	underrange	

4.4 032-1BB30 - AO 2x12Bit 0...10V

Properties

The electronic module has 2 outputs with parameterizable functions. The channels of the module are electrically isolated from the backplane bus. In addition, the channels are isolated to the DC 24V power supply by means of DC/DC converter.

- 2 analog outputs
- Suited for sensors with 0 ... 10V
- Diagnostics function
- 12bit resolution

Structure

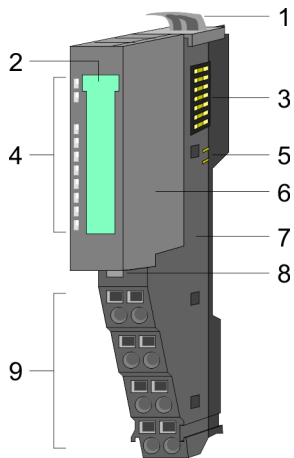

- 1 Locking lever terminal module
- 2 Labeling strip
- 3 Backplane bus
- 4 LED status indication
- 5 DC 24V power section supply
- 6 Electronic module
- 7 Terminal module
- 8 Locking lever electronic module
- 9 Terminal

Status indication

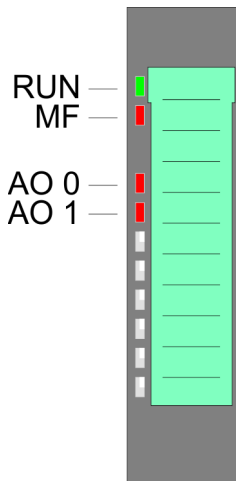

RUN	MF	AO x	Description
■ green	■ red	■ red	
■	<input type="checkbox"/>	X	Bus communication is OK Module status is OK
■	■	X	Bus communication is OK Module status reports an error
<input type="checkbox"/>	■	X	Bus communication is not possible Module status reports an error
<input type="checkbox"/>	<input type="checkbox"/>	X	Error at bus power supply
X	▣ 2Hz	X	Error in configuration ↗ <i>Chap. 2.8 'Trouble shooting - LEDs' page 30</i>
■	<input type="checkbox"/>	■	Error channel x <ul style="list-style-type: none"> ■ Overload, short-circuit ■ Error in parameterization
not relevant: X			

Pin assignment

For wires with a cross section of 0.08mm² up to 1.5mm².

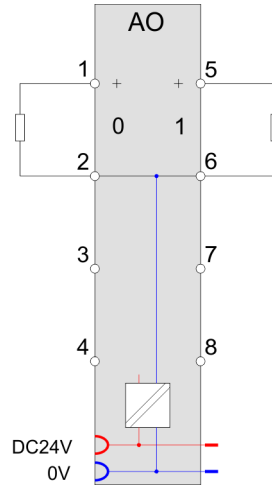
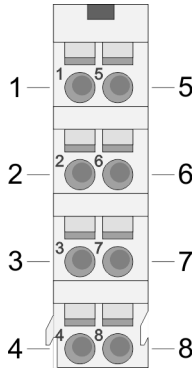

Pos.	Function	Type	Description
1	AO 0	O	Channel 0
2	AGND	O	Ground channels
3	---	---	not connected
4	---	---	not connected
5	AO 1	O	Channel 1
6	AGND	O	Ground channels
7	---	---	not connected
8	---	---	not connected

O: Output

Input area

No byte of the input area is used by the module.

Output area

At CPU, PROFIBUS and PROFINET the output area is embedded to the corresponding address area.

IX - Index for access via CANopen with s = Subindex, depends on number and type of analog modules

SX - Subindex for access via EtherCAT with Index 7000h + EtherCAT-Slot

More can be found in the according manual of your bus coupler.

Addr.	Name	Bytes	Function	IX	SX
+0	AO 0	2	Analog value channel 0	6411h/s	01h
+2	AO 1	2	Analog value channel 1	6411h/s+1	02h

4.4.1 Technical data

Order no.	032-1BB30
Type	SM 032
Module ID	0501 25D8
Current consumption/power loss	
Current consumption from backplane bus	85 mA
Current consumption from load voltage L+ (without load)	35 mA
Power loss	1.2 W
Technical data analog outputs	
Number of outputs	2
Cable length, shielded	200 m
Rated load voltage	DC 24 V
Reverse polarity protection of rated load voltage	✓
Current consumption from rated load voltage	-
Voltage output short-circuit protection	✓
Voltage outputs	✓
Min. load resistance (voltage range)	5 kΩ
Max. capacitive load (current range)	1 μF
Max. inductive load (current range)	10 mA
Output voltage ranges	0 V ... +10 V
Operational limit of voltage ranges	+/-0.3%
Basic error limit voltage ranges	+/-0.2%
Destruction limit against external applied voltage	max. 24V
Current outputs	-
Max. in load resistance (current range)	-
Max. inductive load (current range)	-
Typ. open circuit voltage current output	-
Output current ranges	-
Operational limit of current ranges	-
Basic error limit current ranges	-
Destruction limit against external applied voltage	-
Settling time for ohmic load	1.5 ms
Settling time for capacitive load	2 ms
Settling time for inductive load	-
Resolution in bit	12
Conversion time	2 ms all channels
Substitute value can be applied	no

032-1BB30 - AO 2x12Bit 0...10V > Technical data

Order no.	032-1BB30
Output data size	4 Byte
Status information, alarms, diagnostics	
Status display	yes
Interrupts	no
Process alarm	no
Diagnostic interrupt	no
Diagnostic functions	yes
Diagnostics information read-out	possible
Supply voltage display	green LED
Group error display	red LED
Channel error display	red LED per channel
Isolation	
Between channels	-
Between channels of groups to	-
Between channels and backplane bus	✓
Between channels and power supply	✓
Max. potential difference between circuits	-
Max. potential difference between inputs (U _{cm})	-
Max. potential difference between Mana and Mintern (U _{iso})	DC 75 V/ AC 50 V
Max. potential difference between inputs and Mana (U _{cm})	-
Max. potential difference between inputs and Mintern (U _{iso})	-
Max. potential difference between Mintern and outputs	-
Insulation tested with	DC 500 V
Datasizes	
Input bytes	0
Output bytes	4
Parameter bytes	8
Diagnostic bytes	20
Housing	
Material	PPE / PPE GF10
Mounting	Profile rail 35 mm
Mechanical data	
Dimensions (WxHxD)	12.9 mm x 109 mm x 76.5 mm
Net weight	60 g
Weight including accessories	60 g

Order no.	032-1BB30
Gross weight	74 g
Environmental conditions	
Operating temperature	0 °C to 60 °C
Storage temperature	-25 °C to 70 °C
Certifications	
UL certification	yes
KC certification	yes

4.4.2 Parameter data

DS - Record set for access via CPU, PROFIBUS and PROFINET

IX - Index for access via CANopen

SX - Subindex for access via EtherCAT with Index 3100h + EtherCAT-Slot

More can be found in the according manual of your bus coupler.

Name	Bytes	Function	Default	DS	IX	SX
RES0	1	reserved	00h	00h	3100h	01h
SHORT_EN	1	Short-circuit recognition	00h	00h	3101h	02h
CH0FN	1	Function number channel 0	10h	80h	3102h	03h
CH1FN	1	Function number channel 1	10h	81h	3103h	04h

SHORT_EN Short-circuit recognition

Byte	Bit 7 ... 0
0	<ul style="list-style-type: none"> ■ Bit 0: Short-circuit recognition channel 0 (1:on) ■ Bit 1: Short-circuit recognition channel 1 (1:on) ■ Bit 7 ... 2: reserved

CHxFN Function number channel x

In the following there are the measuring ranges with corresponding function number listed, which were supported by the analog module. With FFh the corresponding channel is deactivated.

The formulas listed here allow you to transform an evaluated measuring value (digital value) to a value assigned to the measuring range (analog value) and vice versa.

0 ... 10V

Output range (funct. no.)	Voltage (U)	Decimal (D)	Hex	Range	Formulas
0 ... 10V Siemens S7 format (10h)	11,76V	32511	7EFFh	overrange	$U = D \times \frac{10}{27648}$ $D = 27648 \times \frac{U}{10}$
	10V	27648	6C00h	nominal range	
	5V	13824	3600h		
	0V	0	0000h		
	Not possible, is limited to 0V.				
0 ... 10V Siemens S5 format (20h)	12,5V	20480	5000h	overrange	$U = D \times \frac{10}{16384}$ $D = 16384 \times \frac{U}{10}$
	10V	16384	4000h	nominal range	
	5V	8192	2000h		
	0V	0	0000h		
	Not possible, is limited to 0V.				

4.4.3 Diagnostic data

So this module does not support diagnostic interrupt functions, the diagnostics data serve for information about this module. On error the corresponding channel LED of the module is activated and the error is registered in the diagnostics data.

The following errors are listed in the diagnostics data:

- Error in project engineering / parameterization
- Short-circuit/overload (if parameterized)

DS - Record set for access via CPU, PROFIBUS and PROFINET. The access happens by DS 01h. Additionally the first 4 bytes may be accessed by DS 00h.

IX - Index for access via CANopen. The access happens by IX 2F01h. Additionally the first 4 bytes may be accessed by IX 2F00h.

SX - Subindex for access via EtherCAT with Index 5005h.

More can be found in the according manual of your bus coupler.

Name	Bytes	Function	Default	DS	IX	SX
ERR_A	1	Diagnostic	00h	01h	2F01h	02h
MODTYP	1	Module information	15h			03h
ERR_C	1	reserved	00h			04h
ERR_D	1	Diagnostic	00h			05h
CHTYP	1	Channel type	73h			06h
NUMBIT	1	Number diagnostic bits per channel	08h			07h
NUMCH	1	Number of channels of a module	02h			08h
CHERR	1	Channel error	00h			09h
CH0ERR	1	Channel-specific error channel 0	00h			0Ah

Name	Bytes	Function	Default	DS	IX	SX
CH1ERR	1	Channel-specific error channel 1	00h			0Bh
CH2ERR... CH7ERR	6	reserved	00h			0Ch ... 11h
DIAG_US	4	µs ticker	00h			13h

ERR_A Diagnostic

Byte	Bit 7 ... 0
0	<ul style="list-style-type: none"> ■ Bit 0: set at module failure ■ Bit 1: set at internal error ■ Bit 2: set at external error ■ Bit 3: set at channel error ■ Bit 4: set at external auxiliary supply missing ■ Bit 6 ... 5: reserved ■ Bit 7: set at error in parameterization

MODTYP Module information

Byte	Bit 7 ... 0
0	<ul style="list-style-type: none"> ■ Bit 3 ... 0: module class <ul style="list-style-type: none"> – 0101b analog module ■ Bit 4: set at channel information present ■ Bit 7 ... 5: reserved

ERR_D Diagnostic

Byte	Bit 7 ... 0
0	<ul style="list-style-type: none"> ■ Bit 2 ... 0: reserved ■ Bit 3: set at internal diagnostics buffer overflow ■ Bit 4: set at internal communication error ■ Bit 7 ... 5: reserved

CHTYP Channel type

Byte	Bit 7 ... 0
0	<ul style="list-style-type: none"> ■ Bit 6 ... 0: Channel type <ul style="list-style-type: none"> – 70h: Digital input – 71h: Analog input – 72h: Digital output – 73h: Analog output – 74h: Analog input/output – 76h: Counter ■ Bit 7: reserved

NUMBIT Diagnostic bits

Byte	Bit 7 ... 0
0	Number of diagnostic bits per channel (here 08h)

032-1BB30 - AO 2x12Bit 0...10V > Diagnostic data

NUMCH Channels

Byte	Bit 7 ... 0
0	Number of channels of a module (here 02h)

CHERR Channel error

Byte	Bit 7 ... 0
0	<ul style="list-style-type: none"> ■ Bit 0: set at error in channel group 0 ■ Bit 1: set at error in channel group 1 ■ Bit 7 ... 2: reserved

**CH0ERR / CH1ERR
Channel specific**

Byte	Bit 7 ... 0
0	Channel-specific error channel x: <ul style="list-style-type: none"> ■ Bit 0: set at configuring/parameter assignment error ■ Bit 2 ... 1: reserved ■ Bit 3: set at short-circuit to ground ■ Bit 7 ... 4: reserved

**CH2ERR ... CH7ERR
reserved**

Byte	Bit 7 ... 0
0	reserved

DIAG_US μ s ticker

Byte	Bit 7 ... 0
0...3	Value of the μ s ticker at the moment of the diagnostic

 μ s ticker

In the System SLIO module there is a timer (μ s ticker). With PowerON the timer starts counting with 0. After $2^{32}-1\mu$ s the timer starts with 0 again.

4.5 032-1BB40 - AO 2x12Bit 0(4)...20mA

Properties

The electronic module has 2 outputs with parameterizable functions. The channels of the module are electrically isolated from the backplane bus. In addition, the channels are isolated to the DC 24V power supply by means of DC/DC converter.

- 2 analog outputs
- Suited for sensors with 0 ... 20mA; 4 ... 20mA
- Diagnostics function
- 12bit resolution

Structure

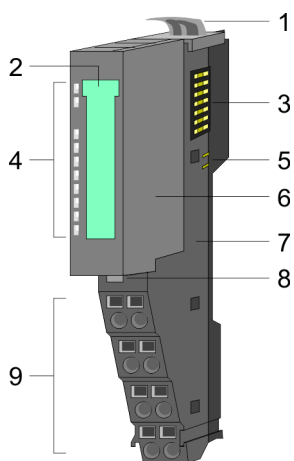

- 1 Locking lever terminal module
- 2 Labeling strip
- 3 Backplane bus
- 4 LED status indication
- 5 DC 24V power section supply
- 6 Electronic module
- 7 Terminal module
- 8 Locking lever electronic module
- 9 Terminal

Status indication

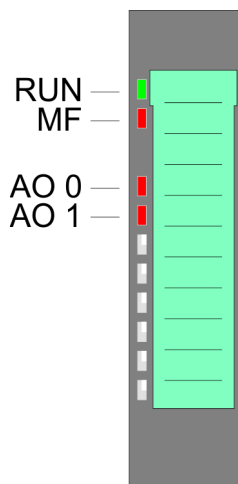

RUN	MF	AO x	Description
<input checked="" type="checkbox"/> green	<input checked="" type="checkbox"/> red	<input checked="" type="checkbox"/> red	
<input checked="" type="checkbox"/>	<input type="checkbox"/>	X	Bus communication is OK Module status is OK
<input checked="" type="checkbox"/>	<input checked="" type="checkbox"/>	X	Bus communication is OK Module status reports an error
<input type="checkbox"/>	<input checked="" type="checkbox"/>	X	Bus communication is not possible Module status reports an error
<input type="checkbox"/>	<input type="checkbox"/>	X	Error at bus power supply
X	<input checked="" type="checkbox"/> 2Hz	X	Error in configuration ↗ <i>Chap. 2.8 'Trouble shooting - LEDs' page 30</i>
<input checked="" type="checkbox"/>	<input type="checkbox"/>	<input checked="" type="checkbox"/>	Error channel x <ul style="list-style-type: none"> ■ Error in parameterization ■ Wire break (if parameterized)
not relevant: X			

032-1BB40 - AO 2x12Bit 0(4)...20mA

Pin assignment

For wires with a cross section of 0.08mm² up to 1.5mm².

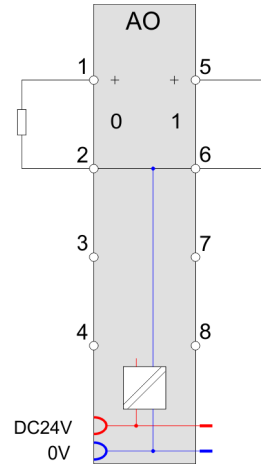
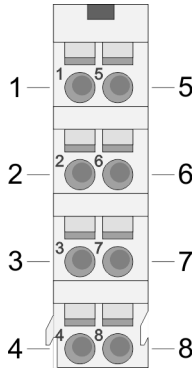

Pos.	Function	Type	Description
1	AO 0	O	Channel 0
2	AGND	O	Ground channels
3	---	---	not connected
4	---	---	not connected
5	AO 1	O	Channel 1
6	AGND	O	Ground channels
7	---	---	not connected
8	---	---	not connected

O: Output

Input area

No byte of the input area is used by the module.

Output area

At CPU, PROFIBUS and PROFINET the output area is embedded to the corresponding address area.

IX - Index for access via CANopen with s = Subindex, depends on number and type of analog modules

SX - Subindex for access via EtherCAT with Index 7000h + EtherCAT-Slot

More can be found in the according manual of your bus coupler.

Addr.	Name	Bytes	Function	IX	SX
+0	AO 0	2	Analog value channel 0	6411h/s	01h
+2	AO 1	2	Analog value channel 1	6411h/s+1	02h

4.5.1 Technical data

Order no.	032-1BB40
Type	SM 032
Module ID	0502 25D8
Current consumption/power loss	
Current consumption from backplane bus	85 mA
Current consumption from load voltage L+ (without load)	15 mA
Power loss	0.8 W
Technical data analog outputs	
Number of outputs	2
Cable length, shielded	200 m
Rated load voltage	DC 24 V
Reverse polarity protection of rated load voltage	✓
Current consumption from rated load voltage	-
Voltage output short-circuit protection	-
Voltage outputs	-
Min. load resistance (voltage range)	-
Max. capacitive load (current range)	-
Max. inductive load (current range)	-
Output voltage ranges	-
Operational limit of voltage ranges	-
Basic error limit voltage ranges	-
Destruction limit against external applied voltage	-
Current outputs	✓
Max. in load resistance (current range)	350 Ω
Max. inductive load (current range)	10 mH
Typ. open circuit voltage current output	12 V
Output current ranges	0 mA ... +20 mA +4 mA ... +20 mA
Operational limit of current ranges	+/-0.4% ... +/-0.5%
Basic error limit current ranges	+/-0.2% ... +/-0.3%
Destruction limit against external applied voltage	max. 12V (30V for 1s)
Settling time for ohmic load	0.25 ms
Settling time for capacitive load	-
Settling time for inductive load	1.5 ms
Resolution in bit	12
Conversion time	2 ms all channels

032-1BB40 - AO 2x12Bit 0(4)...20mA > Technical data

Order no.	032-1BB40
Substitute value can be applied	no
Output data size	4 Byte
Status information, alarms, diagnostics	
Status display	yes
Interrupts	no
Process alarm	no
Diagnostic interrupt	no
Diagnostic functions	yes
Diagnostics information read-out	possible
Supply voltage display	green LED
Group error display	red LED
Channel error display	red LED per channel
Isolation	
Between channels	-
Between channels of groups to	-
Between channels and backplane bus	✓
Between channels and power supply	✓
Max. potential difference between circuits	-
Max. potential difference between inputs (U _{cm})	-
Max. potential difference between Mana and Mintern (U _{iso})	DC 75 V/ AC 50 V
Max. potential difference between inputs and Mana (U _{cm})	-
Max. potential difference between inputs and Mintern (U _{iso})	-
Max. potential difference between Mintern and outputs	-
Insulation tested with	DC 500 V
Datasizes	
Input bytes	0
Output bytes	4
Parameter bytes	8
Diagnostic bytes	20
Housing	
Material	PPE / PPE GF10
Mounting	Profile rail 35 mm
Mechanical data	
Dimensions (WxHxD)	12.9 mm x 109 mm x 76.5 mm
Net weight	61 g

Order no.	032-1BB40
Weight including accessories	61 g
Gross weight	75 g
Environmental conditions	
Operating temperature	0 °C to 60 °C
Storage temperature	-25 °C to 70 °C
Certifications	
UL certification	yes
KC certification	yes

4.5.2 Parameter data

DS - Record set for access via CPU, PROFIBUS and PROFINET

IX - Index for access via CANopen

SX - Subindex for access via EtherCAT with Index 3100h + EtherCAT-Slot

More can be found in the according manual of your bus coupler.

Name	Bytes	Function	Default	DS	IX	SX
RES0	1	reserved	00h	00h	3100h	01h
WIBRK_EN	1	Wire-break recognition	00h	00h	3101h	02h
CH0FN	1	Function number channel 0	31h	80h	3102h	03h
CH1FN	1	Function number channel 1	31h	81h	3103h	04h

WIBRK_EN Wire-break recognition

You also can activate the wire-break recognition for the current output range 0 ... 20mA. To ensure a safe wire-break recognition, the decimal value for the output is ≥ 100 .

Byte	Bit 7 ... 0
0	<ul style="list-style-type: none"> ■ Bit 0: Wire-break recognition channel 0 (1: on) ■ Bit 1: Wire-break recognition channel 1 (1: on) ■ Bit 7 ... 2: reserved

CHxFN Function number channel x

In the following there are the measuring ranges with corresponding function number listed, which were supported by the analog module. With FFh the corresponding channel is deactivated. The formulas listed here allow you to transform an evaluated measuring value (digital value) to a value assigned to the measuring range (analog value) and vice versa.

0 ... 20mA

Output range (funct. no.)	Current (I)	Decimal (D)	Hex	Range	Formulas
0 ... 20mA Siemens S7 format (31h)	23.52mA	32511	7EFFh	overrange	$I = D \times \frac{20}{27648}$ $D = 27648 \times \frac{I}{20}$
	20mA	27648	6C00h	nominal range	
	10mA	13824	3600h		
	0mA	0	0000h		
	Not possible, is limited to 0mA.				
0 ... 20mA Siemens S5 format (41h)	25.00mA	20480	5000h	overrange	$I = D \times \frac{20}{16384}$ $D = 16384 \times \frac{I}{20}$
	20mA	16384	4000h	nominal range	
	10mA	8192	2000h		
	0mA	0	0000h		
	Not possible, is limited to 0mA.				

4 ... 20mA

Output range (funct. no.)	Current (I)	Decimal (D)	Hex	Range	Formulas
4 ... 20mA Siemens S7 format (30h)	22.81mA	32511	7EFFh	overrange	$I = D \times \frac{16}{27648} + 4$ $D = 27648 \times \frac{I-4}{16}$
	20mA	27648	6C00h	nominal range	
	12mA	13824	3600h		
	4mA	0	0000h		
	0mA	-6912	E500h	underrange	
4 ... 20mA Siemens S5 format (40h)	24.00mA	20480	5000h	overrange	$I = D \times \frac{16}{16384} + 4$ $D = 16384 \times \frac{I-4}{16}$
	20mA	16384	4000h	nominal range	
	12mA	8192	2000h		
	4mA	0	0000h		
	0mA	-4096	F000h	underrange	

4.5.3 Diagnostic data

So this module does not support diagnostic interrupt functions, the diagnostics data serve for information about this module. On error the corresponding channel LED of the module is activated and the error is registered in the diagnostics data.

The following errors are listed in the diagnostics data:

- Error in project engineering / parameterization
- Wire-break (if parameterized)

DS - Record set for access via CPU, PROFIBUS and PROFINET. The access happens by DS 01h. Additionally the first 4 bytes may be accessed by DS 00h.

IX - Index for access via CANopen. The access happens by IX 2F01h. Additionally the first 4 bytes may be accessed by IX 2F00h.

SX - Subindex for access via EtherCAT with Index 5005h.

More can be found in the according manual of your bus coupler.

Name	Bytes	Function	Default	DS	IX	SX
ERR_A	1	Diagnostic	00h	01h	2F01h	02h
MODTYP	1	Module information	15h			03h
ERR_C	1	reserved	00h			04h
ERR_D	1	Diagnostic	00h			05h
CHTYP	1	Channel type	73h			06h
NUMBIT	1	Number diagnostic bits per channel	08h			07h
NUMCH	1	Number of channels of a module	02h			08h
CHERR	1	Channel error	00h			09h
CH0ERR	1	Channel-specific error channel 0	00h			0Ah
CH1ERR	1	Channel-specific error channel 1	00h			0Bh
CH2ERR... CH7ERR	6	reserved	00h			0Ch ... 11h
DIAG_US	4	µs ticker	00h			13h

ERR_A Diagnostic

Byte	Bit 7 ... 0
0	<ul style="list-style-type: none"> ■ Bit 0: set at module failure ■ Bit 1: set at internal error ■ Bit 2: set at external error ■ Bit 3: set at channel error ■ Bit 4: set at external auxiliary supply missing ■ Bit 6 ... 5: reserved ■ Bit 7: set at error in parameterization

032-1BB40 - AO 2x12Bit 0(4)...20mA > Diagnostic data

MODTYP Module information

Byte	Bit 7 ... 0
0	<ul style="list-style-type: none"> ■ Bit 3 ... 0: module class <ul style="list-style-type: none"> – 0101b analog module ■ Bit 4: set at channel information present ■ Bit 7 ... 5: reserved

ERR_D Diagnostic

Byte	Bit 7 ... 0
0	<ul style="list-style-type: none"> ■ Bit 2 ... 0: reserved ■ Bit 3: set at internal diagnostics buffer overflow ■ Bit 4: set at internal communication error ■ Bit 7 ... 5: reserved

CHTYP Channel type

Byte	Bit 7 ... 0
0	<ul style="list-style-type: none"> ■ Bit 6 ... 0: Channel type <ul style="list-style-type: none"> – 70h: Digital input – 71h: Analog input – 72h: Digital output – 73h: Analog output – 74h: Analog input/output – 76h: Counter ■ Bit 7: reserved

NUMBIT Diagnostic bits

Byte	Bit 7 ... 0
0	Number of diagnostic bits per channel (here 08h)

NUMCH Channels

Byte	Bit 7 ... 0
0	Number of channels of a module (here 02h)

CHERR Channel error

Byte	Bit 7 ... 0
0	<ul style="list-style-type: none"> ■ Bit 0: set at error in channel group 0 ■ Bit 1: set at error in channel group 1 ■ Bit 7 ... 2: reserved

CH0ERR / CH1ERR Channel-specific

Byte	Bit 7 ... 0
0	Channel-specific error channel x <ul style="list-style-type: none"> ■ Bit 0: set at configuring/parameter assignment error ■ Bit 3 ... 1: reserved ■ Bit 4: set at wire-break ■ Bit 7 ... 5: reserved

**CH2ERR ... CH7ERR
reserved**

Byte	Bit 7 ... 0
0	reserved

DIAG_US μ s ticker

Byte	Bit 7 ... 0
0...3	Value of the μ s ticker at the moment of the diagnostic

 μ s ticker

In the System SLIO module there is a timer (μ s ticker). With PowerON the timer starts counting with 0. After $2^{32}-1\mu$ s the timer starts with 0 again.

4.6 032-1BB70 - AO 2x12Bit ±10V

Properties

The electronic module has 2 outputs with parameterizable functions. The channels of the module are electrically isolated from the backplane bus. In addition, the channels are isolated to the DC 24V power supply by means of DC/DC converter.

- 2 analog outputs
- Suited for sensors with ±10V, 0 ... 10V
- Diagnostics function
- 12bit resolution

Structure

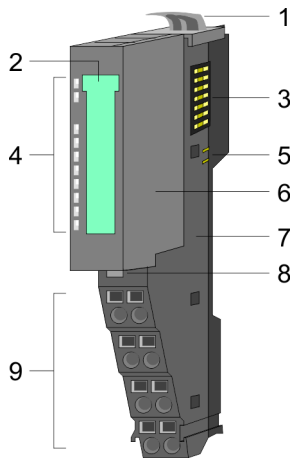

- 1 Locking lever terminal module
- 2 Labeling strip
- 3 Backplane bus
- 4 LED status indication
- 5 DC 24V power section supply
- 6 Electronic module
- 7 Terminal module
- 8 Locking lever electronic module
- 9 Terminal

Status indication

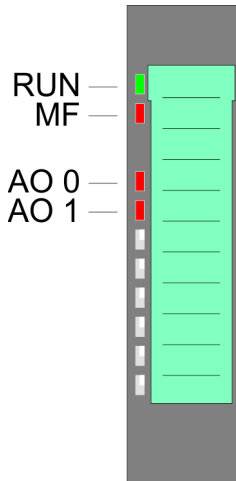

RUN	MF	AO x	Description
■ green	■ red	■ red	
■	<input type="checkbox"/>	X	Bus communication is OK Module status is OK
■	■	X	Bus communication is OK Module status reports an error
<input type="checkbox"/>	■	X	Bus communication is not possible Module status reports an error
<input type="checkbox"/>	<input type="checkbox"/>	X	Error at bus power supply
X	▬ 2Hz	X	Error in configuration ↗ <i>Chap. 2.8 'Trouble shooting - LEDs' page 30</i>
■	<input type="checkbox"/>	■	Error channel x <ul style="list-style-type: none"> ■ Overload, short-circuit ■ Error in parameterization
not relevant: X			

Pin assignment

For wires with a cross section of 0.08mm² up to 1.5mm².

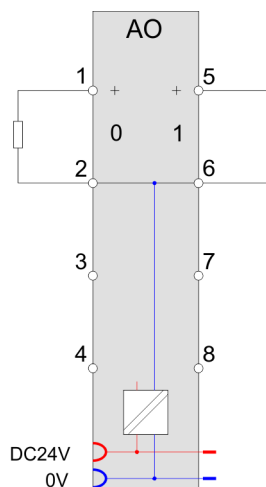
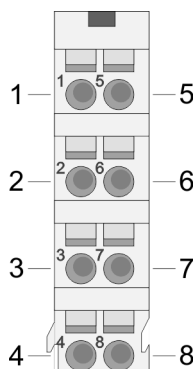

Pos.	Function	Type	Description
1	AO 0	O	Channel 0
2	AGND	O	Ground channels
3	---	---	not connected
4	---	---	not connected
5	AO 1	O	Channel 1
6	AGND	O	Ground channels
7	---	---	not connected
8	---	---	not connected

O: Output

Input area

No byte of the input area is used by the module.

Output area

At CPU, PROFIBUS and PROFINET the output area is embedded to the corresponding address area.

IX - Index for access via CANopen with s = Subindex, depends on number and type of analog modules

SX - Subindex for access via EtherCAT with Index 7000h + EtherCAT-Slot

More can be found in the according manual of your bus coupler.

Adr.	Name	Bytes	Function	IX	SX
+0	AO 0	2	Analog value channel 0	6411h/s	01h
+2	AO 1	2	Analog value channel 1	6411h/s+1	02h

4.6.1 Technical data

Order no.	032-1BB70
Type	SM 032
Module ID	0505 25D8
Current consumption/power loss	
Current consumption from backplane bus	60 mA
Current consumption from load voltage L+ (without load)	20 mA
Power loss	0.8 W
Technical data analog outputs	
Number of outputs	2
Cable length, shielded	200 m
Rated load voltage	DC 24 V
Reverse polarity protection of rated load voltage	✓
Current consumption from rated load voltage	-
Voltage output short-circuit protection	✓
Voltage outputs	✓
Min. load resistance (voltage range)	5 k Ω
Max. capacitive load (current range)	1 μ F
Max. inductive load (current range)	10 mA
Output voltage ranges	-10 V ... +10 V 0 V ... +10 V
Operational limit of voltage ranges	+/-0.3%
Basic error limit voltage ranges	+/-0.2%
Destruction limit against external applied voltage	max. 24V
Current outputs	-
Max. in load resistance (current range)	-
Max. inductive load (current range)	-
Typ. open circuit voltage current output	-
Output current ranges	-
Operational limit of current ranges	-
Basic error limit current ranges	-
Destruction limit against external applied voltage	-
Settling time for ohmic load	3 ms
Settling time for capacitive load	3 ms
Settling time for inductive load	-
Resolution in bit	12
Conversion time	2 ms all channels

Order no.	032-1BB70
Substitute value can be applied	no
Output data size	4 Byte
Status information, alarms, diagnostics	
Status display	yes
Interrupts	no
Process alarm	no
Diagnostic interrupt	no
Diagnostic functions	yes
Diagnostics information read-out	possible
Supply voltage display	green LED
Group error display	red LED
Channel error display	red LED per channel
Isolation	
Between channels	-
Between channels of groups to	-
Between channels and backplane bus	✓
Between channels and power supply	✓
Max. potential difference between circuits	-
Max. potential difference between inputs (U _{cm})	-
Max. potential difference between Mana and Mintern (U _{iso})	DC 75 V/ AC 50 V
Max. potential difference between inputs and Mana (U _{cm})	-
Max. potential difference between inputs and Mintern (U _{iso})	-
Max. potential difference between Mintern and outputs	-
Insulation tested with	DC 500 V
Datasizes	
Input bytes	0
Output bytes	4
Parameter bytes	8
Diagnostic bytes	20
Housing	
Material	PPE / PPE GF10
Mounting	Profile rail 35 mm
Mechanical data	
Dimensions (WxHxD)	12.9 mm x 109 mm x 76.5 mm
Net weight	58 g

032-1BB70 - AO 2x12Bit ±10V > Parameter data

Order no.	032-1BB70
Weight including accessories	58 g
Gross weight	73 g
Environmental conditions	
Operating temperature	0 °C to 60 °C
Storage temperature	-25 °C to 70 °C
Certifications	
UL certification	yes
KC certification	yes

4.6.2 Parameter data

DS - Record set for access via CPU, PROFIBUS and PROFINET

IX - Index for access via CANopen

SX - Subindex for access via EtherCAT with Index 3100h + EtherCAT-Slot

More can be found in the according manual of your bus coupler.

Name	Bytes	Function	Default	DS	IX	SX
RES0	1	reserved	00h	00h	3100h	01h
SHORT_EN	1	Short-circuit recognition	00h	00h	3101h	02h
CH0FN	1	Function number channel 0	12h	80h	3102h	03h
CH1FN	1	Function number channel 1	12h	81h	3103h	04h

SHORT_EN Short-circuit recognition

Byte	Bit 7 ... 0
0	<ul style="list-style-type: none"> ■ Bit 0: Short-circuit recognition channel 0 (1:on) ■ Bit 1: Short-circuit recognition channel 1 (1:on) ■ Bit 7 ... 2: reserved

CHxFN Function number channel x

In the following there are the measuring ranges with corresponding function number listed, which were supported by the analog module. With FFh the corresponding channel is deactivated. The formulas listed here allow you to transform an evaluated measuring value (digital value) to a value assigned to the measuring range (analog value) and vice versa.

±10V

Output range (funct. no.)	Voltage (U)	Decimal (D)	Hex	Range	Formulas
±10V Siemens S format (12h)	11.76V	32511	7EFFh	overrange	$U = D \times \frac{10}{27648}$ $D = 27648 \times \frac{U}{10}$
	10V	27648	6C00h	nominal range	
	5V	13824	3600h		
	0V	0	0000h		
	-5V	-13824	CA00h		
	-10V	-27648	9400h	underrange	
	-11.76V	-32512	8100h		
±10V Siemens S5 format (22h)	12.5V	20480	5000h	overrange	$U = D \times \frac{10}{16384}$ $D = 16384 \times \frac{U}{10}$
	10V	16384	4000h	nominal range	
	5V	8192	2000h		
	0V	0	0000h		
	-5V	-8192	E000h		
	-10V	-16384	C000h	underrange	
	-12.5V	-20480	B000h		

0 ... 10V

Output range (funct. no.)	Voltage (U)	Decimal (D)	Hex	Range	Formulas
0 ... 10V Siemens S7 format (10h)	11.76V	32511	7EFFh	overrange	$U = D \times \frac{10}{27648}$ $D = 27648 \times \frac{U}{10}$
	10V	27648	6C00h	nominal range	
	5V	13824	3600h		
	0V	0	0000h		
	Not possible, is limited to 0V.				
0 ... 10V Siemens S5 format (20h)	12.5V	20480	5000h	overrange	$U = D \times \frac{10}{16384}$ $D = 16384 \times \frac{U}{10}$
	10V	16384	4000h	nominal range	
	5V	8192	2000h		
	0V	0	0000h		
	Not possible, is limited to 0V.				

4.6.3 Diagnostic data

So this module does not support diagnostic interrupt functions, the diagnostics data serve for information about this module. On error the corresponding channel LED of the module is activated and the error is registered in the diagnostics data.

The following errors are listed in the diagnostics data:

- Error in project engineering / parameterization
- Short-circuit/overload (if parameterized)

DS - Record set for access via CPU, PROFIBUS and PROFINET. The access happens by DS 01h. Additionally the first 4 bytes may be accessed by DS 00h.

IX - Index for access via CANopen. The access happens by IX 2F01h. Additionally the first 4 bytes may be accessed by IX 2F00h.

SX - Subindex for access via EtherCAT with Index 5005h.

More can be found in the according manual of your bus coupler.

Name	Bytes	Function	Default	DS	IX	SX
ERR_A	1	Diagnostic	00h	01h	2F01h	02h
MODTYP	1	Module information	15h			03h
ERR_C	1	reserved	00h			04h
ERR_D	1	Diagnostic	00h			05h
CHTYP	1	Channel type	73h			06h
NUMBIT	1	Number diagnostic bits per channel	08h			07h
NUMCH	1	Number of channels of a module	02h			08h
CHERR	1	Channel error	00h			09h
CH0ERR	1	Channel-specific error channel 0	00h			0Ah
CH1ERR	1	Channel-specific error channel 1	00h			0Bh
CH2ERR... CH7ERR	6	reserved	00h			0Ch ... 11h
DIAG_US	4	μ s ticker	00h			13h

ERR_A Diagnostic

Byte	Bit 7 ... 0
0	<ul style="list-style-type: none"> ■ Bit 0: set at module failure ■ Bit 1: set at internal error ■ Bit 2: set at external error ■ Bit 3: set at channel error ■ Bit 4: set at external auxiliary supply missing ■ Bit 6 ... 5: reserved ■ Bit 7: set at error in parameterization

MODTYP Module information

Byte	Bit 7 ... 0
0	<ul style="list-style-type: none"> ■ Bit 3 ... 0: module class <ul style="list-style-type: none"> – 0101b analog module ■ Bit 4: set at channel information present ■ Bit 7 ... 5: reserved

ERR_D Diagnostic

Byte	Bit 7 ... 0
0	<ul style="list-style-type: none"> ■ Bit 2 ... 0: reserved ■ Bit 3: set at internal diagnostics buffer overflow ■ Bit 4: set at internal communication error ■ Bit 7 ... 5: reserved

CHTYP Channel type

Byte	Bit 7 ... 0
0	<ul style="list-style-type: none"> ■ Bit 6 ... 0: Channel type <ul style="list-style-type: none"> – 70h: Digital input – 71h: Analog input – 72h: Digital output – 73h: Analog output – 74h: Analog input/output – 76h: Counter ■ Bit 7: reserved

NUMBIT Diagnostic bits

Byte	Bit 7 ... 0
0	Number of diagnostic bits per channel (here 08h)

NUMCH Channels

Byte	Bit 7 ... 0
0	Number of channels of a module (here 02h)

CHERR Channel error

Byte	Bit 7 ... 0
0	<ul style="list-style-type: none"> ■ Bit 0: set at error in channel group 0 ■ Bit 1: set at error in channel group 1 ■ Bit 7 ... 2: reserved

CH0ERR / CH1ERR Channel-specific

Byte	Bit 7 ... 0
0	Channel-specific error channel x: <ul style="list-style-type: none"> ■ Bit 0: set at configuring/parameter assignment error ■ Bit 2 ... 1: reserved ■ Bit 3: set at short-circuit to ground ■ Bit 7 ... 4: reserved

032-1BB70 - AO 2x12Bit $\pm 10V$ > Diagnostic data

CH2ERR ... CH7ERR
reserved

Byte	Bit 7 ... 0
0	reserved

DIAG_US μs ticker

Byte	Bit 7 ... 0
0...3	Value of the μs ticker at the moment of the diagnostic

μs ticker

In the System SLIO module there is a timer (μs ticker). With PowerON the timer starts counting with 0. After $2^{32}-1\mu s$ the timer starts with 0 again.

4.7 032-1BD30 - AO 4x12Bit 0...10V

Properties

The electronic module has 4 outputs with parameterizable functions. The channels of the module are electrically isolated from the backplane bus. In addition, the channels are isolated to the DC 24V power supply by means of DC/DC converter.

- 4 analog outputs
- Suited for sensors with 0 ... 10V
- Diagnostics function
- 12bit resolution

Structure

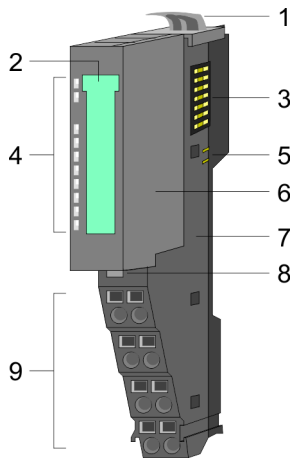

- 1 Locking lever terminal module
- 2 Labeling strip
- 3 Backplane bus
- 4 LED status indication
- 5 DC 24V power section supply
- 6 Electronic module
- 7 Terminal module
- 8 Locking lever electronic module
- 9 Terminal

Status indication

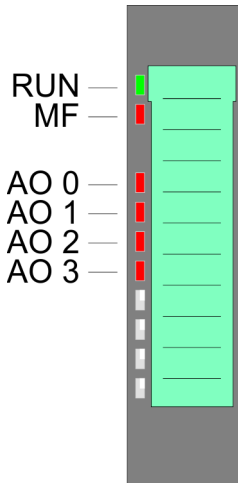

RUN	MF	AO x	Description
■ green	■ red	■ red	
■	□	X	Bus communication is OK Module status is OK
■	■	X	Bus communication is OK Module status reports an error
□	■	X	Bus communication is not possible Module status reports an error
□	□	X	Error at bus power supply
X	▣ 2Hz	X	Error in configuration ↗ <i>Chap. 2.8 'Trouble shooting - LEDs' page 30</i>
■	□	■	Error channel x <ul style="list-style-type: none"> ■ Overload, short-circuit ■ Error in parameterization
not relevant: X			

Pin assignment

For wires with a cross section of 0.08mm² up to 1.5mm².

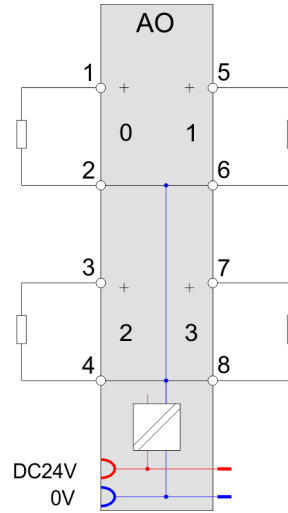
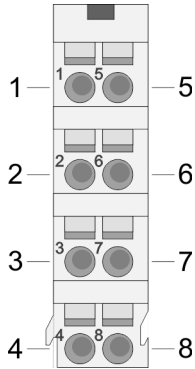

Pos.	Function	Type	Description
1	AO 0	O	Channel 0
2	AGND	O	Ground channels
3	AO 2	O	Channel 2
4	AGND	O	Ground channels
5	AO 1	O	Channel 1
6	AGND	O	Ground channels
7	AO 3	O	Channel 3
8	AGND	O	Ground channels

O: Output

Input area

No byte of the input area is used by the module.

Output area

At CPU, PROFIBUS and PROFINET the output area is embedded to the corresponding address area.

IX - Index for access via CANopen with s = Subindex, depends on number and type of analog modules

SX - Subindex for access via EtherCAT with Index 7000h + EtherCAT-Slot

More can be found in the according manual of your bus coupler.

Addr.	Name	Bytes	Function	IX	SX
+0	AO 0	2	Analog value channel 0	6411h/s	01h
+2	AO 1	2	Analog value channel 1	6411h/s+1	02h
+4	AO 2	2	Analog value channel 2	6411h/s+2	03h
+6	AO 3	2	Analog value channel 3	6411h/s+3	04h

4.7.1 Technical data

Order no.	032-1BD30
Type	SM 032
Module ID	0503 25E0
Current consumption/power loss	
Current consumption from backplane bus	90 mA
Current consumption from load voltage L+ (without load)	35 mA
Power loss	1.2 W
Technical data analog outputs	
Number of outputs	4
Cable length, shielded	200 m
Rated load voltage	DC 24 V
Reverse polarity protection of rated load voltage	✓
Current consumption from rated load voltage	-
Voltage output short-circuit protection	✓
Voltage outputs	✓
Min. load resistance (voltage range)	5 kΩ
Max. capacitive load (current range)	1 μF
Max. inductive load (current range)	10 mA
Output voltage ranges	0 V ... +10 V
Operational limit of voltage ranges	+/-0.3%
Basic error limit voltage ranges	+/-0.2%
Destruction limit against external applied voltage	max. 24V
Current outputs	-
Max. in load resistance (current range)	-
Max. inductive load (current range)	-
Typ. open circuit voltage current output	-
Output current ranges	-
Operational limit of current ranges	-
Basic error limit current ranges	-
Destruction limit against external applied voltage	-
Settling time for ohmic load	1.5 ms
Settling time for capacitive load	2 ms
Settling time for inductive load	-
Resolution in bit	12
Conversion time	2 ms all channels
Substitute value can be applied	no

032-1BD30 - AO 4x12Bit 0...10V > Technical data

Order no.	032-1BD30
Output data size	8 Byte
Status information, alarms, diagnostics	
Status display	yes
Interrupts	no
Process alarm	no
Diagnostic interrupt	no
Diagnostic functions	yes
Diagnostics information read-out	possible
Supply voltage display	green LED
Group error display	red LED
Channel error display	red LED per channel
Isolation	
Between channels	-
Between channels of groups to	-
Between channels and backplane bus	✓
Between channels and power supply	✓
Max. potential difference between circuits	-
Max. potential difference between inputs (U _{cm})	-
Max. potential difference between Mana and Mintern (U _{iso})	DC 75 V/ AC 50 V
Max. potential difference between inputs and Mana (U _{cm})	-
Max. potential difference between inputs and Mintern (U _{iso})	-
Max. potential difference between Mintern and outputs	-
Insulation tested with	DC 500 V
Datasizes	
Input bytes	0
Output bytes	8
Parameter bytes	10
Diagnostic bytes	20
Housing	
Material	PPE / PPE GF10
Mounting	Profile rail 35 mm
Mechanical data	
Dimensions (WxHxD)	12.9 mm x 109 mm x 76.5 mm
Net weight	61 g
Weight including accessories	61 g

Order no.	032-1BD30
Gross weight	75 g
Environmental conditions	
Operating temperature	0 °C to 60 °C
Storage temperature	-25 °C to 70 °C
Certifications	
UL certification	yes
KC certification	yes

4.7.2 Parameter data

DS - Record set for access via CPU, PROFIBUS and PROFINET

IX - Index for access via CANopen

SX - Subindex for access via EtherCAT with Index 3100h + EtherCAT-Slot

More can be found in the according manual of your bus coupler.

Name	Bytes	Function	Default	DS	IX	SX
RES0	1	reserved	00h	00h	3100h	01h
SHORT_EN	1	Short-circuit recognition	00h	00h	3101h	02h
CH0FN	1	Function number channel 0	10h	80h	3102h	03h
CH1FN	1	Function number channel 1	10h	81h	3103h	04h
CH2FN	1	Function number channel 2	10h	82h	3104h	05h
CH3FN	1	Function number channel 3	10h	83h	3105h	06h

SHORT_EN Short-circuit recognition

Byte	Bit 7 ... 0
0	<ul style="list-style-type: none"> ■ Bit 0: Short-circuit recognition channel 0 (1:on) ■ Bit 1: Short-circuit recognition channel 1 (1:on) ■ Bit 2: Short-circuit recognition channel 2 (1:on) ■ Bit 3: Short-circuit recognition channel 3 (1:on) ■ Bit 7 ... 4: reserved

CHxFN Function number channel x

In the following there are the measuring ranges with corresponding function number listed, which were supported by the analog module. With FFh the corresponding channel is deactivated. The formulas listed here allow you to transform an evaluated measuring value (digital value) to a value assigned to the measuring range (analog value) and vice versa.

0 ... 10V

Output range (funct. no.)	Voltage (U)	Decimal (D)	Hex	Range	Formulas
0 ... 10V Siemens S7 format (10h)	11,76V	32511	7EFFh	overrange	$U = D \times \frac{10}{27648}$ $D = 27648 \times \frac{U}{10}$
	10V	27648	6C00h	nominal range	
	5V	13824	3600h		
	0V	0	0000h		
	Not possible, is limited to 0V.				
0 ... 10V Siemens S5 format (20h)	12,5V	20480	5000h	overrange	$U = D \times \frac{10}{16384}$ $D = 16384 \times \frac{U}{10}$
	10V	16384	4000h	nominal range	
	5V	8192	2000h		
	0V	0	0000h		
	Not possible, is limited to 0V.				

4.7.3 Diagnostic data

So this module does not support diagnostic interrupt functions, the diagnostics data serve for information about this module. On error the corresponding channel LED of the module is activated and the error is registered in the diagnostics data.

The following errors are listed in the diagnostics data:

- Error in project engineering / parameterization
- Short-circuit/overload (if parameterized)

DS - Record set for access via CPU, PROFIBUS and PROFINET. The access happens by DS 01h. Additionally the first 4 bytes may be accessed by DS 00h.

IX - Index for access via CANopen. The access happens by IX 2F01h. Additionally the first 4 bytes may be accessed by IX 2F00h.

SX - Subindex for access via EtherCAT with Index 5005h.

More can be found in the according manual of your bus coupler.

Name	Bytes	Function	Default	DS	IX	SX
ERR_A	1	Diagnostic	00h	01h	2F01h	02h
MODTYP	1	Module information	15h			03h
ERR_C	1	reserved	00h			04h
ERR_D	1	Diagnostic	00h			05h
CHTYP	1	Channel type	73h			06h
NUMBIT	1	Number diagnostic bits per channel	08h			07h
NUMCH	1	Number of channels of a module	04h			08h
CHERR	1	Channel error	00h			09h
CH0ERR	1	Channel-specific error channel 0	00h			0Ah

Name	Bytes	Function	Default	DS	IX	SX
CH1ERR	1	Channel-specific error channel 1	00h			0Bh
CH2ERR	1	Channel-specific error channel 2	00h			0Ch
CH3ERR	1	Channel-specific error channel 3	00h			0Dh
CH4ERR... CH7ERR	4	reserved	00h			0Eh ... 11h
DIAG_US	4	µs ticker	00h			13h

ERR_A Diagnostic

Byte	Bit 7 ... 0
0	<ul style="list-style-type: none"> ■ Bit 0: set at module failure ■ Bit 1: set at internal error ■ Bit 2: set at external error ■ Bit 3: set at channel error ■ Bit 4: set at external auxiliary supply missing ■ Bit 6 ... 5: reserved ■ Bit 7: set at error in parameterization

MODTYP Module information

Byte	Bit 7 ... 0
0	<ul style="list-style-type: none"> ■ Bit 3 ... 0: module class <ul style="list-style-type: none"> – 0101b analog module ■ Bit 4: set at channel information present ■ Bit 7 ... 5: reserved

ERR_D Diagnostic

Byte	Bit 7 ... 0
0	<ul style="list-style-type: none"> ■ Bit 2 ... 0: reserved ■ Bit 3: set at internal diagnostics buffer overflow ■ Bit 4: set at internal communication error ■ Bit 7 ... 5: reserved

CHTYP Channel type

Byte	Bit 7 ... 0
0	<ul style="list-style-type: none"> ■ Bit 6 ... 0: Channel type <ul style="list-style-type: none"> – 70h: Digital input – 71h: Analog input – 72h: Digital output – 73h: Analog output – 74h: Analog input/-output – 76h: Counter ■ Bit 7: reserved

NUMBIT Diagnostic bits

Byte	Bit 7 ... 0
0	Number of diagnostic bits per channel (here 08h)

032-1BD30 - AO 4x12Bit 0...10V > Diagnostic data

NUMCH Channels

Byte	Bit 7 ... 0
0	Number of channels of a module (here 04h)

CHERR Channel error

Byte	Bit 7 ... 0
0	<ul style="list-style-type: none"> ■ Bit 0: set at error in channel group 0 ■ Bit 1: set at error in channel group 1 ■ Bit 2: set at error in channel group 2 ■ Bit 3: set at error in channel group 3 ■ Bit 7 ... 4: reserved

**CH0ERR ... CH3ERR
Channel-specific**

Byte	Bit 7 ... 0
0	Channel-specific error channel x: <ul style="list-style-type: none"> ■ Bit 0: set at configuring/parameter assignment error ■ Bit 2 ... 1: reserved ■ Bit 3: set at short-circuit to ground ■ Bit 7 ... 4: reserved

**CH4ERR ... CH7ERR
reserved**

Byte	Bit 7 ... 0
0	reserved

DIAG_US μ s ticker

Byte	Bit 7 ... 0
0...3	Value of the μ s ticker at the moment of the diagnostic

 μ s ticker

In the System SLIO module there is a timer (μ s ticker). With PowerON the timer starts counting with 0. After $2^{32}-1\mu$ s the timer starts with 0 again.

4.8 032-1BD40 - AO 4x12Bit 0(4)...20mA

Properties

The electronic module has 4 outputs with parameterizable functions. The channels of the module are electrically isolated from the backplane bus. In addition, the channels are isolated to the DC 24V power supply by means of DC/DC converter.

- 4 analog outputs
- Suited for sensors with 0...20mA; 4...20mA
- Diagnostics function
- 12bit resolution

Structure

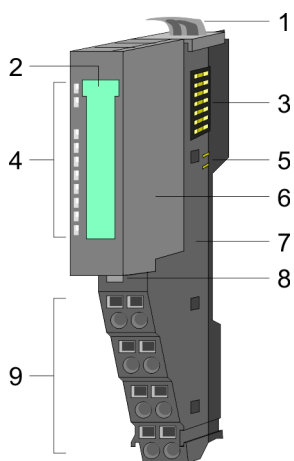

- 1 Locking lever terminal module
- 2 Labeling strip
- 3 Backplane bus
- 4 LED status indication
- 5 DC 24V power section supply
- 6 Electronic module
- 7 Terminal module
- 8 Locking lever electronic module
- 9 Terminal

Status indication

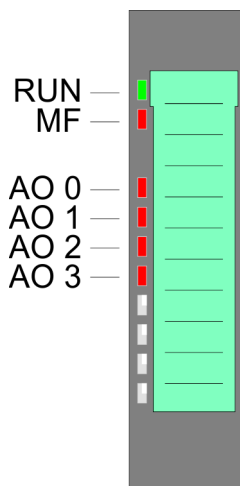

RUN	MF	AO x	Description
<input checked="" type="checkbox"/> green	<input checked="" type="checkbox"/> red	<input checked="" type="checkbox"/> red	
<input checked="" type="checkbox"/>	<input type="checkbox"/>	X	Bus communication is OK Module status is OK
<input checked="" type="checkbox"/>	<input checked="" type="checkbox"/>	X	Bus communication is OK Module status reports an error
<input type="checkbox"/>	<input checked="" type="checkbox"/>	X	Bus communication is not possible Module status reports an error
<input type="checkbox"/>	<input type="checkbox"/>	X	Error at bus power supply
X	<input checked="" type="checkbox"/> 2Hz	X	Error in configuration ↗ <i>Chap. 2.8 'Trouble shooting - LEDs' page 30</i>
<input checked="" type="checkbox"/>	<input type="checkbox"/>	<input checked="" type="checkbox"/>	Error channel x <ul style="list-style-type: none"> ■ Error in parameterization ■ Wire break (if parameterized)
not relevant: X			

032-1BD40 - AO 4x12Bit 0(4)...20mA

Pin assignment

For wires with a cross section of 0.08mm² up to 1.5mm².

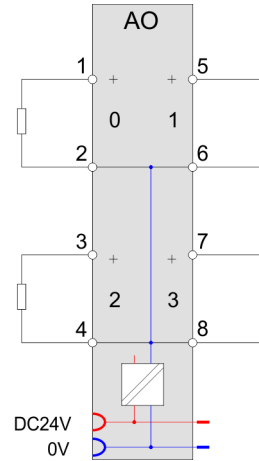
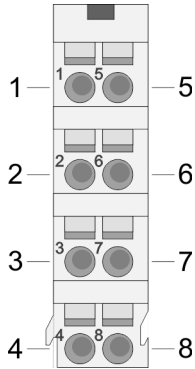

Pos.	Function	Type	Description
1	AO 0	O	Channel 0
2	AGND	O	Ground channels
3	AO 2	O	Channel 2
4	AGND	O	Ground channels
5	AO 1	O	Channel 1
6	AGND	O	Ground channels
7	AO 3	O	Channel 3
8	AGND	O	Ground channels

O: Output

Input area

No byte of the input area is used by the module.

Output area

At CPU, PROFIBUS and PROFINET the output area is embedded to the corresponding address area.

IX - Index for access via CANopen with s = Subindex, depends on number and type of analog modules

SX - Subindex for access via EtherCAT with Index 7000h + EtherCAT-Slot

More can be found in the according manual of your bus coupler.

Addr.	Name	Bytes	Function	IX	SX
+0	AO 0	2	Analog value channel 0	6411h/s	01h
+2	AO 1	2	Analog value channel 1	6411h/s+1	02h
+4	AO 2	2	Analog value channel 2	6411h/s+2	03h
+6	AO 3	2	Analog value channel 3	6411h/s+3	04h

4.8.1 Technical data

Order no.	032-1BD40
Type	SM 032
Module ID	0504 25E0
Current consumption/power loss	
Current consumption from backplane bus	90 mA
Current consumption from load voltage L+ (without load)	15 mA
Power loss	0.8 W
Technical data analog outputs	
Number of outputs	4
Cable length, shielded	200 m
Rated load voltage	DC 24 V
Reverse polarity protection of rated load voltage	✓
Current consumption from rated load voltage	-
Voltage output short-circuit protection	-
Voltage outputs	-
Min. load resistance (voltage range)	-
Max. capacitive load (current range)	-
Max. inductive load (current range)	-
Output voltage ranges	-
Operational limit of voltage ranges	-
Basic error limit voltage ranges	-
Destruction limit against external applied voltage	-
Current outputs	✓
Max. in load resistance (current range)	350 Ω
Max. inductive load (current range)	10 mH
Typ. open circuit voltage current output	12 V
Output current ranges	0 mA ... +20 mA +4 mA ... +20 mA
Operational limit of current ranges	+/-0.4% ... +/-0.5%
Basic error limit current ranges	+/-0.2% ... +/-0.3%
Destruction limit against external applied voltage	max. 12V (30V for 1s)
Settling time for ohmic load	0.25 ms
Settling time for capacitive load	-
Settling time for inductive load	1.5 ms
Resolution in bit	12
Conversion time	2 ms all channels

032-1BD40 - AO 4x12Bit 0(4)...20mA > Technical data

Order no.	032-1BD40
Substitute value can be applied	no
Output data size	8 Byte
Status information, alarms, diagnostics	
Status display	yes
Interrupts	no
Process alarm	no
Diagnostic interrupt	no
Diagnostic functions	yes
Diagnostics information read-out	possible
Supply voltage display	green LED
Group error display	red LED
Channel error display	red LED per channel
Isolation	
Between channels	-
Between channels of groups to	-
Between channels and backplane bus	✓
Between channels and power supply	✓
Max. potential difference between circuits	-
Max. potential difference between inputs (U _{cm})	-
Max. potential difference between Mana and Mintern (U _{iso})	DC 75 V/ AC 50 V
Max. potential difference between inputs and Mana (U _{cm})	-
Max. potential difference between inputs and Mintern (U _{iso})	-
Max. potential difference between Mintern and outputs	-
Insulation tested with	DC 500 V
Datasizes	
Input bytes	0
Output bytes	8
Parameter bytes	10
Diagnostic bytes	20
Housing	
Material	PPE / PPE GF10
Mounting	Profile rail 35 mm
Mechanical data	
Dimensions (WxHxD)	12.9 mm x 109 mm x 76.5 mm
Net weight	61 g

Order no.	032-1BD40
Weight including accessories	61 g
Gross weight	75 g
Environmental conditions	
Operating temperature	0 °C to 60 °C
Storage temperature	-25 °C to 70 °C
Certifications	
UL certification	yes
KC certification	yes

4.8.2 Parameter data

DS - Record set for access via CPU, PROFIBUS and PROFINET

IX - Index for access via CANopen

SX - Subindex for access via EtherCAT with Index 3100h + EtherCAT-Slot

More can be found in the according manual of your bus coupler.

Name	Bytes	Function	Default	DS	IX	SX
RES0	1	reserved	00h	00h	3100h	01h
WIBRK_EN	1	Wire-break recognition	00h	00h	3101h	02h
CH0FN	1	Function number channel 0	31h	80h	3102h	03h
CH1FN	1	Function number channel 1	31h	81h	3103h	04h
CH2FN	1	Function number channel 2	31h	82h	3104h	05h
CH3FN	1	Function number channel 3	31h	83h	3105h	06h

WIBRK_EN Wire-break recognition

You also can activate the wire-break recognition for the current output range 0 ... 20mA. To ensure a safe wire-break recognition, the decimal value for the output is ≥ 100 .

Byte	Bit 7 ... 0
0	<ul style="list-style-type: none"> ■ Bit 0: Wire-break recognition channel 0 (1: on) ■ Bit 1: Wire-break recognition channel 1 (1: on) ■ Bit 2: Wire-break recognition channel 2 (1: on) ■ Bit 3: Wire-break recognition channel 3 (1: on) ■ Bit 7 ... 4: reserved

CHxFN Function number channel x

In the following there are the measuring ranges with corresponding function number listed, which were supported by the analog module. With FFh the corresponding channel is deactivated. The formulas listed here allow you to transform an evaluated measuring value (digital value) to a value assigned to the measuring range (analog value) and vice versa.

0 ... 20mA

Output range (funct. no.)	Current (I)	Decimal (D)	Hex	Range	Formulas
0 ... 20mA Siemens S7 format (31h)	23.52mA	32511	7EFFh	overrange	$I = D \times \frac{20}{27648}$ $D = 27648 \times \frac{I}{20}$
	20mA	27648	6C00h	nominal range	
	10mA	13824	3600h		
	0mA	0	0000h		
	Not possible, is limited to 0mA.				
0 ... 20mA Siemens S5 format (41h)	25.00mA	20480	5000h	overrange	$I = D \times \frac{20}{16384}$ $D = 16384 \times \frac{I}{20}$
	20mA	16384	4000h	nominal range	
	10mA	8192	2000h		
	0mA	0	0000h		
	Not possible, is limited to 0mA.				

4 ... 20mA

Output range (funct. no.)	Current (I)	Decimal (D)	Hex	Range	Formulas
4 ... 20mA Siemens S7 format (30h)	22.81mA	32511	7EFFh	overrange	$I = D \times \frac{16}{27648} + 4$ $D = 27648 \times \frac{I-4}{16}$
	20mA	27648	6C00h	nominal range	
	12mA	13824	3600h		
	4mA	0	0000h		
	0mA	-6912	E500h	underrange	
4 ... 20mA Siemens S5 format (40h)	24.00mA	20480	5000h	overrange	$I = D \times \frac{16}{16384} + 4$ $D = 16384 \times \frac{I-4}{16}$
	20mA	16384	4000h	nominal range	
	12mA	8192	2000h		
	4mA	0	0000h		
	0mA	-4096	F000h	underrange	

4.8.3 Diagnostic data

So this module does not support interrupt functions, the diagnostics data serve for information about this module. On error the corresponding channel LED of the module is activated and the error is registered in the diagnostics data.

The following errors are listed in the diagnostics data:

- Error in project engineering / parameterization
- Wire-break (if parameterized)

DS - Record set for access via CPU, PROFIBUS and PROFINET. The access happens by DS 01h. Additionally the first 4 bytes may be accessed by DS 00h.

IX - Index for access via CANopen. The access happens by IX 2F01h. Additionally the first 4 bytes may be accessed by IX 2F00h.

SX - Subindex for access via EtherCAT with Index 5005h.

More can be found in the according manual of your bus coupler.

Name	Bytes	Function	Default	DS	IX	SX
ERR_A	1	Diagnostic	00h	01h	2F01h	02h
MODTYP	1	Module information	15h			03h
ERR_C	1	reserved	00h			04h
ERR_D	1	Diagnostic	00h			05h
CHTYP	1	Channel type	73h			06h
NUMBIT	1	Number diagnostic bits per channel	08h			07h
NUMCH	1	Number of channels of a module	04h			08h
CHERR	1	Channel error	00h			09h
CH0ERR	1	Channel-specific error channel 0	00h			0Ah
CH1ERR	1	Channel-specific error channel 1	00h			0Bh
CH2ERR	1	Channel-specific error channel 2	00h			0Ch
CH3ERR	1	Channel-specific error channel 3	00h			0Dh
CH4ERR... CH7ERR	4	reserved	00h			0Eh ... 11h
DIAG_US	4	µs ticker	00h			13h

ERR_A Diagnostic

Byte	Bit 7 ... 0
0	<ul style="list-style-type: none"> ■ Bit 0: set at module failure ■ Bit 1: set at internal error ■ Bit 2: set at external error ■ Bit 3: set at channel error ■ Bit 4: set at external auxiliary supply missing ■ Bit 6 ... 5: reserved ■ Bit 7: set at error in parameterization

032-1BD40 - AO 4x12Bit 0(4)...20mA > Diagnostic data

MODTYP Module information

Byte	Bit 7 ... 0
0	<ul style="list-style-type: none"> ■ Bit 3 ... 0: module class <ul style="list-style-type: none"> – 0101b analog module ■ Bit 4: set at channel information present ■ Bit 7 ... 5: reserved

ERR_D Diagnostic

Byte	Bit 7 ... 0
0	<ul style="list-style-type: none"> ■ Bit 2 ... 0: reserved ■ Bit 3: set at internal diagnostics buffer overflow ■ Bit 4: set at internal communication error ■ Bit 7 ... 5: reserved

CHTYP Channel type

Byte	Bit 7 ... 0
0	<ul style="list-style-type: none"> ■ Bit 6 ... 0: Channel type <ul style="list-style-type: none"> – 70h: Digital input – 71h: Analog input – 72h: Digital output – 73h: Analog output – 74h: Analog input/output – 76h: Counter ■ Bit 7: reserved

NUMBIT Diagnostic bits

Byte	Bit 7 ... 0
0	Number of diagnostic bits per channel (here 08h)

NUMCH Channels

Byte	Bit 7 ... 0
0	Number of channels of a module (here 04h)

CHERR Channel error

Byte	Bit 7 ... 0
0	<ul style="list-style-type: none"> ■ Bit 0: set at error in channel group 0 ■ Bit 1: set at error in channel group 1 ■ Bit 2: set at error in channel group 2 ■ Bit 3: set at error in channel group 3 ■ Bit 7 ... 4: reserved

CH0ERR ... CH3ERR Channel-specific

Byte	Bit 7 ... 0
0	Channel-specific error channel x: <ul style="list-style-type: none"> ■ Bit 0: set at configuring/parameter assignment error ■ Bit 3 ... 1: reserved ■ Bit 4: set at wire-break ■ Bit 7 ... 5: reserved

DIAG_US μ s ticker

Byte	Bit 7 ... 0
0...3	Value of the μ s ticker at the moment of the diagnostic

 μ s ticker

In the System SLIO module there is a timer (μ s ticker). With PowerON the timer starts counting with 0. After $2^{32}-1\mu$ s the timer starts with 0 again.

4.9 032-1BD70 - AO 4x12Bit ±10V

Properties

The electronic module has 4 outputs with parameterizable functions. The channels of the module are electrically isolated from the backplane bus. In addition, the channels are isolated to the DC 24V power supply by means of DC/DC converter.

- 4 analog outputs
- Suited for sensors with ±10V, 0 ... 10V
- Diagnostics function
- 12bit resolution

Structure

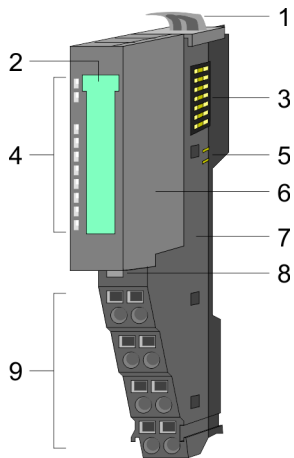

- 1 Locking lever terminal module
- 2 Labeling strip
- 3 Backplane bus
- 4 LED status indication
- 5 DC 24V power section supply
- 6 Electronic module
- 7 Terminal module
- 8 Locking lever electronic module
- 9 Terminal

Status indication

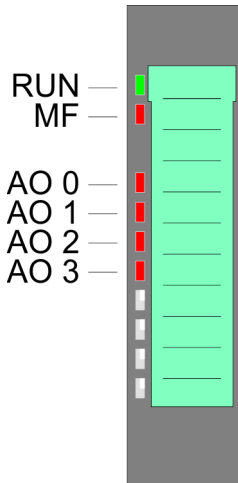

RUN	MF	AO x	Description
■ green	■ red	■ red	
■	<input type="checkbox"/>	X	Bus communication is OK Module status is OK
■	■	X	Bus communication is OK Module status reports an error
<input type="checkbox"/>	■	X	Bus communication is not possible Module status reports an error
<input type="checkbox"/>	<input type="checkbox"/>	X	Error at bus power supply
X	▣ 2Hz	X	Error in configuration ↗ <i>Chap. 2.8 'Trouble shooting - LEDs' page 30</i>
■	<input type="checkbox"/>	■	Error channel x <ul style="list-style-type: none"> ■ Overload, short-circuit ■ Error in parameterization
not relevant: X			

Pin assignment

For wires with a cross section of 0.08mm² up to 1.5mm².

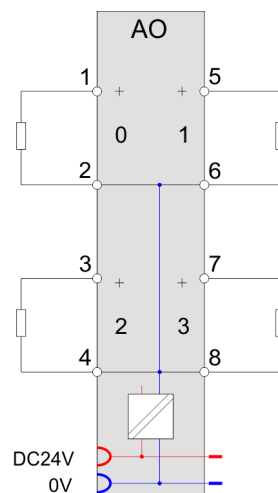
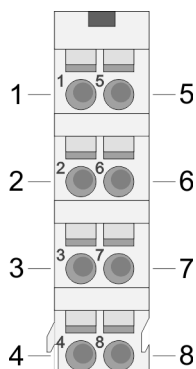

Pos.	Function	Type	Description
1	AO 0	O	Channel 0
2	AGND	O	Ground channels
3	AO 2	O	Channel 2
4	AGND	O	Ground channels
5	AO 1	O	Channel 1
6	AGND	O	Ground channels
7	AO 3	O	Channel 3
8	AGND	O	Ground channels

O: Output

Input area

No byte of the input area is used by the module.

Output area

At CPU, PROFIBUS and PROFINET the output area is embedded to the corresponding address area.

IX - Index for access via CANopen with s = Subindex, depends on number and type of analog modules

SX - Subindex for access via EtherCAT with Index 7000h + EtherCAT-Slot

More can be found in the according manual of your bus coupler.

Addr.	Name	Bytes	Function	IX	SX
+0	AO 0	2	Analog value channel 0	6411h/s	01h
+2	AO 1	2	Analog value channel 1	6411h/s+1	02h
+4	AO 2	2	Analog value channel 2	6411h/s+2	03h
+6	AO 3	2	Analog value channel 3	6411h/s+3	04h

4.9.1 Technical data

Order no.	032-1BD70
Type	SM 032
Module ID	0506 25E0
Current consumption/power loss	
Current consumption from backplane bus	60 mA
Current consumption from load voltage L+ (without load)	20 mA
Power loss	0.8 W
Technical data analog outputs	
Number of outputs	4
Cable length, shielded	200 m
Rated load voltage	DC 24 V
Reverse polarity protection of rated load voltage	✓
Current consumption from rated load voltage	-
Voltage output short-circuit protection	✓
Voltage outputs	✓
Min. load resistance (voltage range)	5 k Ω
Max. capacitive load (current range)	1 μ F
Max. inductive load (current range)	10 mA
Output voltage ranges	-10 V ... +10 V 0 V ... +10 V
Operational limit of voltage ranges	+/-0.3%
Basic error limit voltage ranges	+/-0.2%
Destruction limit against external applied voltage	max. 24V
Current outputs	-
Max. in load resistance (current range)	-
Max. inductive load (current range)	-
Typ. open circuit voltage current output	-
Output current ranges	-
Operational limit of current ranges	-
Basic error limit current ranges	-
Destruction limit against external applied voltage	-
Settling time for ohmic load	3 ms
Settling time for capacitive load	3 ms
Settling time for inductive load	-
Resolution in bit	12
Conversion time	2 ms all channels

Order no.	032-1BD70
Substitute value can be applied	no
Output data size	8 Byte
Status information, alarms, diagnostics	
Status display	yes
Interrupts	no
Process alarm	no
Diagnostic interrupt	no
Diagnostic functions	yes
Diagnostics information read-out	possible
Supply voltage display	green LED
Group error display	red LED
Channel error display	red LED per channel
Isolation	
Between channels	-
Between channels of groups to	-
Between channels and backplane bus	✓
Between channels and power supply	✓
Max. potential difference between circuits	-
Max. potential difference between inputs (U _{cm})	-
Max. potential difference between Mana and Mintern (U _{iso})	DC 75 V/ AC 50 V
Max. potential difference between inputs and Mana (U _{cm})	-
Max. potential difference between inputs and Mintern (U _{iso})	-
Max. potential difference between Mintern and outputs	-
Insulation tested with	DC 500 V
Datasizes	
Input bytes	0
Output bytes	8
Parameter bytes	10
Diagnostic bytes	20
Housing	
Material	PPE / PPE GF10
Mounting	Profile rail 35 mm
Mechanical data	
Dimensions (WxHxD)	12.9 mm x 109 mm x 76.5 mm
Net weight	62 g

032-1BD70 - AO 4x12Bit ±10V > Parameter data

Order no.	032-1BD70
Weight including accessories	62 g
Gross weight	76 g
Environmental conditions	
Operating temperature	0 °C to 60 °C
Storage temperature	-25 °C to 70 °C
Certifications	
UL certification	yes
KC certification	yes

4.9.2 Parameter data

DS - Record set for access via CPU, PROFIBUS and PROFINET

IX - Index for access via CANopen

SX - Subindex for access via EtherCAT with Index 3100h + EtherCAT-Slot

More can be found in the according manual of your bus coupler.

Name	Bytes	Function	Default	DS	IX	SX
RES0	1	reserved	00h	00h	3100h	01h
SHORT_EN	1	Short-circuit recognition	00h	00h	3101h	02h
CH0FN	1	Function number channel 0	12h	80h	3102h	03h
CH1FN	1	Function number channel 1	12h	81h	3103h	04h
CH2FN	1	Function number channel 2	12h	82h	3104h	05h
CH3FN	1	Function number channel 3	12h	83h	3105h	06h

SHORT_EN Short-circuit recognition

Byte	Bit 7 ... 0
0	<ul style="list-style-type: none"> ■ Bit 0: Short-circuit recognition channel 0 (1:on) ■ Bit 1: Short-circuit recognition channel 1 (1:on) ■ Bit 2: Short-circuit recognition channel 2 (1:on) ■ Bit 3: Short-circuit recognition channel 3 (1:on) ■ Bit 7 ... 4: reserved

CHxFN Function number channel x

In the following there are the measuring ranges with corresponding function number listed, which were supported by the analog module. With FFh the corresponding channel is deactivated. The formulas listed here allow you to transform an evaluated measuring value (digital value) to a value assigned to the measuring range (analog value) and vice versa.

$\pm 10V$

Output range (funct. no.)	Voltage (U)	Decimal (D)	Hex	Range	Formulas
$\pm 10V$ Siemens S format (12h)	11.76V	32511	7EFFh	overrange	$U = D \times \frac{10}{27648}$ $D = 27648 \times \frac{U}{10}$
	10V	27648	6C00h	nominal range	
	5V	13824	3600h		
	0V	0	0000h		
	-5V	-13824	CA00h		
	-10V	-27648	9400h	underrange	
	-11.76V	-32512	8100h		
$\pm 10V$ Siemens S5 format (22h)	12.5V	20480	5000h	overrange	$U = D \times \frac{10}{16384}$ $D = 16384 \times \frac{U}{10}$
	10V	16384	4000h	nominal range	
	5V	8192	2000h		
	0V	0	0000h		
	-5V	-8192	E000h		
	-10V	-16384	C000h		
	-12.5V	-20480	B000h		

0 ... 10V

Output range (funct. no.)	Voltage (U)	Decimal (D)	Hex	Range	Formulas
0 ... 10V Siemens S7 format (10h)	11.76V	32511	7EFFh	overrange	$U = D \times \frac{10}{27648}$ $D = 27648 \times \frac{U}{10}$
	10V	27648	6C00h	nominal range	
	5V	13824	3600h		
	0V	0	0000h		
	Not possible, is limited to 0V.				
0 ... 10V Siemens S5 format (20h)	12.5V	20480	5000h	overrange	$U = D \times \frac{10}{16384}$ $D = 16384 \times \frac{U}{10}$
	10V	16384	4000h	nominal range	
	5V	8192	2000h		
	0V	0	0000h		
	Not possible, is limited to 0V.				

4.9.3 Diagnostic data

So this module does not support diagnostic interrupt functions, the diagnostics data serve for information about this module. On error the corresponding channel LED of the module is activated and the error is registered in the diagnostics data.

The following errors are listed in the diagnostics data:

- Error in project engineering / parameterization
- Short-circuit/overload (if parameterized)

DS - Record set for access via CPU, PROFIBUS and PROFINET. The access happens by DS 01h. Additionally the first 4 bytes may be accessed by DS 00h.

IX - Index for access via CANopen. The access happens by IX 2F01h. Additionally the first 4 bytes may be accessed by IX 2F00h.

SX - Subindex for access via EtherCAT with Index 5005h.

More can be found in the according manual of your bus coupler.

Name	Bytes	Function	Default	DS	IX	SX
ERR_A	1	Diagnostic	00h	01h	2F01h	02h
MODTYP	1	Module information	15h			03h
ERR_C	1	reserved	00h			04h
ERR_D	1	Diagnostic	00h			05h
CHTYP	1	Channel type	73h			06h
NUMBIT	1	Number diagnostic bits per channel	08h			07h
NUMCH	1	Number of channels of a module	04h			08h
CHERR	1	Channel error	00h			09h
CH0ERR	1	Channel-specific error channel 0	00h			0Ah
CH1ERR	1	Channel-specific error channel 1	00h			0Bh
CH2ERR	1	Channel-specific error channel 2	00h			0Ch
CH3ERR	1	Channel-specific error channel 3	00h			0Dh
CH4ERR... CH7ERR	4	reserved	00h			0Eh ... 11h
DIAG_US	4	µs ticker	00h			13h

ERR_A Diagnostic

Byte	Bit 7 ... 0
0	<ul style="list-style-type: none"> ■ Bit 0: set at module failure ■ Bit 1: set at internal error ■ Bit 2: set at external error ■ Bit 3: set at channel error ■ Bit 4: set at external auxiliary supply missing ■ Bit 6 ... 5: reserved ■ Bit 7: set at error in parameterization

MODTYP Module information

Byte	Bit 7 ... 0
0	<ul style="list-style-type: none"> ■ Bit 3 ... 0: module class <ul style="list-style-type: none"> – 0101b analog module ■ Bit 4: set at channel information present ■ Bit 7 ... 5: reserved

ERR_D Diagnostic

Byte	Bit 7 ... 0
0	<ul style="list-style-type: none"> ■ Bit 2 ... 0: reserved ■ Bit 3: set at internal diagnostics buffer overflow ■ Bit 4: set at internal communication error ■ Bit 7 ... 5: reserved

CHTYP Channel type

Byte	Bit 7 ... 0
0	<ul style="list-style-type: none"> ■ Bit 6 ... 0: Channel type <ul style="list-style-type: none"> – 70h: Digital input – 71h: Analog input – 72h: Digital output – 73h: Analog output – 74h: Analog input/output – 76h: Counter ■ Bit 7: reserved

NUMBIT Diagnostic bits

Byte	Bit 7 ... 0
0	Number of diagnostic bits per channel (here 08h)

NUMCH Channels

Byte	Bit 7 ... 0
0	Number of channels of a module (here 04h)

CHERR Channel error

Byte	Bit 7 ... 0
0	<ul style="list-style-type: none"> ■ Bit 0: set at error in channel group 0 ■ Bit 1: set at error in channel group 1 ■ Bit 2: set at error in channel group 2 ■ Bit 3: set at error in channel group 3 ■ Bit 7 ... 4: reserved

CH0ERR ... CH3ERR Channel-specific

Byte	Bit 7 ... 0
0	Channel-specific error channel x: <ul style="list-style-type: none"> ■ Bit 0: set at configuring/parameter assignment error ■ Bit 2 ... 1: reserved ■ Bit 3: set at short-circuit to ground ■ Bit 7 ... 4: reserved

032-1BD70 - AO 4x12Bit $\pm 10V$ > Diagnostic data

CH4ERR ... CH7ERR
reserved

Byte	Bit 7 ... 0
0	reserved

DIAG_US μs ticker

Byte	Bit 7 ... 0
0...3	Value of the μs ticker at the moment of the diagnostic

μs ticker

In the System SLIO module there is a timer (μs ticker). With PowerON the timer starts counting with 0. After $2^{32}-1\mu s$ the timer starts with 0 again.

4.10 032-1CB30 - AO 2x16Bit 0...10V

Properties

The electronic module has 2 outputs with parameterizable functions. The channels of the module are electrically isolated from the backplane bus. In addition, the channels are isolated to the DC 24V power supply by means of DC/DC converter.

- 2 analog outputs
- Suited for sensors with 0 ... 10V
- Diagnostics function
- 16bit resolution

Structure

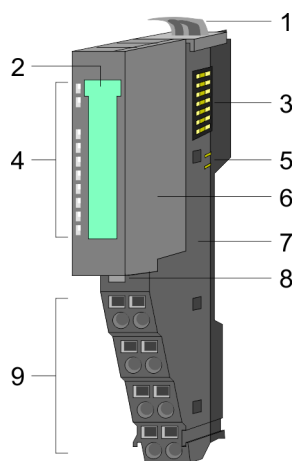

- 1 Locking lever terminal module
- 2 Labeling strip
- 3 Backplane bus
- 4 LED status indication
- 5 DC 24V power section supply
- 6 Electronic module
- 7 Terminal module
- 8 Locking lever electronic module
- 9 Terminal

Status indication

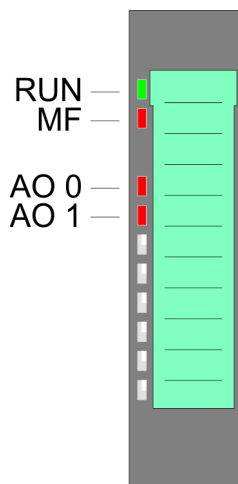

RUN	MF	AO x	Description
■ green	■ red	■ red	
■	<input type="checkbox"/>	X	Bus communication is OK Module status is OK
■	■	X	Bus communication is OK Module status reports an error
<input type="checkbox"/>	■	X	Bus communication is not possible Module status reports an error
<input type="checkbox"/>	<input type="checkbox"/>	X	Error at bus power supply
X	▣ 2Hz	X	Error in configuration ↗ <i>Chap. 2.8 'Trouble shooting - LEDs' page 30</i>
■	<input type="checkbox"/>	■	Error channel x <ul style="list-style-type: none"> ■ Overload, short-circuit ■ Error in parameterization
not relevant: X			

Pin assignment

For wires with a cross section of 0.08mm² up to 1.5mm².

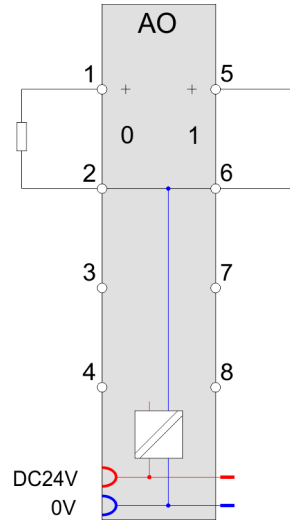
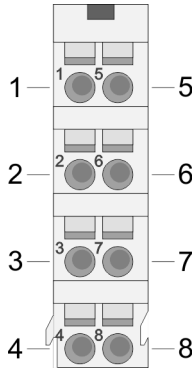

Pos.	Function	Type	Description
1	AO 0	O	Channel 0
2	AGND	O	Ground channels
3	---	---	not connected
4	---	---	not connected
5	AO 1	O	Channel 1
6	AGND	O	Ground channels
7	---	---	not connected
8	---	---	not connected

O: Output

Input area

No byte of the input area is used by the module.

Output area

At CPU, PROFIBUS and PROFINET the output area is embedded to the corresponding address area.

IX - Index for access via CANopen with s = Subindex, depends on number and type of analog modules

SX - Subindex for access via EtherCAT with Index 7000h + EtherCAT-Slot

More can be found in the according manual of your bus coupler.

Addr.	Name	Bytes	Function	IX	SX
+0	AO 0	2	Analog value channel 0	6411h/s	01h
+2	AO 1	2	Analog value channel 1	6411h/s+1	02h

4.10.1 Technical data

Order no.	032-1CB30
Type	SM 032
Module ID	0507 2558
Current consumption/power loss	
Current consumption from backplane bus	60 mA
Current consumption from load voltage L+ (without load)	20 mA
Power loss	0.8 W
Technical data analog outputs	
Number of outputs	2
Cable length, shielded	200 m
Rated load voltage	DC 24 V
Reverse polarity protection of rated load voltage	✓
Current consumption from rated load voltage	-
Voltage output short-circuit protection	✓
Voltage outputs	✓
Min. load resistance (voltage range)	5 kΩ
Max. capacitive load (current range)	1 μF
Max. inductive load (current range)	10 mA
Output voltage ranges	0 V ... +10 V
Operational limit of voltage ranges	+/-0.2%
Basic error limit voltage ranges	+/-0.1%
Destruction limit against external applied voltage	max. 24V
Current outputs	-
Max. in load resistance (current range)	-
Max. inductive load (current range)	-
Typ. open circuit voltage current output	-
Output current ranges	-
Operational limit of current ranges	-
Basic error limit current ranges	-
Destruction limit against external applied voltage	-
Settling time for ohmic load	150 μs
Settling time for capacitive load	1 ms
Settling time for inductive load	-
Resolution in bit	16
Conversion time	200 μs all channels
Substitute value can be applied	no

032-1CB30 - AO 2x16Bit 0...10V > Technical data

Order no.	032-1CB30
Output data size	4 Byte
Status information, alarms, diagnostics	
Status display	yes
Interrupts	no
Process alarm	no
Diagnostic interrupt	no
Diagnostic functions	yes
Diagnostics information read-out	possible
Supply voltage display	green LED
Group error display	red LED
Channel error display	red LED per channel
Isolation	
Between channels	-
Between channels of groups to	-
Between channels and backplane bus	✓
Between channels and power supply	✓
Max. potential difference between circuits	-
Max. potential difference between inputs (U _{cm})	-
Max. potential difference between Mana and Mintern (U _{iso})	DC 75 V/ AC 50 V
Max. potential difference between inputs and Mana (U _{cm})	-
Max. potential difference between inputs and Mintern (U _{iso})	-
Max. potential difference between Mintern and outputs	-
Insulation tested with	DC 500 V
Datasizes	
Input bytes	0
Output bytes	4
Parameter bytes	8
Diagnostic bytes	20
Housing	
Material	PPE / PPE GF10
Mounting	Profile rail 35 mm
Mechanical data	
Dimensions (WxHxD)	12.9 mm x 109 mm x 76.5 mm
Net weight	61 g
Weight including accessories	61 g

Order no.	032-1CB30
Gross weight	75 g
Environmental conditions	
Operating temperature	0 °C to 60 °C
Storage temperature	-25 °C to 70 °C
Certifications	
UL certification	yes
KC certification	yes

4.10.2 Parameter data

DS - Record set for access via CPU, PROFIBUS and PROFINET

IX - Index for access via CANopen

SX - Subindex for access via EtherCAT with Index 3100h + EtherCAT-Slot

More can be found in the according manual of your bus coupler.

Name	Bytes	Function	Default	DS	IX	SX
RES0	1	reserved	00h	00h	3100h	01h
SHORT_EN	1	Short-circuit recognition	00h	00h	3101h	02h
CH0FN	1	Function number channel 0	10h	80h	3102h	03h
CH1FN	1	Function number channel 1	10h	81h	3103h	04h

SHORT_EN Short-circuit recognition

Byte	Bit 7 ... 0
0	<ul style="list-style-type: none"> ■ Bit 0: Short-circuit recognition channel 0 (1:on) ■ Bit 1: Short-circuit recognition channel 1 (1:on) ■ Bit 7 ... 2: reserved

CHxFN Function number channel x

In the following there are the measuring ranges with corresponding function number listed, which were supported by the analog module. With FFh the corresponding channel is deactivated.

The formulas listed here allow you to transform an evaluated measuring value (digital value) to a value assigned to the measuring range (analog value) and vice versa.

0 ... 10V

Output range (funct. no.)	Voltage (U)	Decimal (D)	Hex	Range	Formulas
0 ... 10V Siemens S7 format (10h)	11,76V	32511	7EFFh	overrange	$U = D \times \frac{10}{27648}$ $D = 27648 \times \frac{U}{10}$
	10V	27648	6C00h	nominal range	
	5V	13824	3600h		
	0V	0	0000h		
	Not possible, is limited to 0V.				
0 ... 10V Siemens S5 format (20h)	12,5V	20480	5000h	overrange	$U = D \times \frac{10}{16384}$ $D = 16384 \times \frac{U}{10}$
	10V	16384	4000h	nominal range	
	5V	8192	2000h		
	0V	0	0000h		
	Not possible, is limited to 0V.				

4.10.3 Diagnostic data

So this module does not support diagnostic interrupt functions, the diagnostics data serve for information about this module. On error the corresponding channel LED of the module is activated and the error is registered in the diagnostics data.

The following errors are listed in the diagnostics data:

- Error in project engineering / parameterization
- Short-circuit/overload (if parameterized)

DS - Record set for access via CPU, PROFIBUS and PROFINET. The access happens by DS 01h. Additionally the first 4 bytes may be accessed by DS 00h.

IX - Index for access via CANopen. The access happens by IX 2F01h. Additionally the first 4 bytes may be accessed by IX 2F00h.

SX - Subindex for access via EtherCAT with Index 5005h.

More can be found in the according manual of your bus coupler.

Name	Bytes	Function	Default	DS	IX	SX
ERR_A	1	Diagnostic	00h	01h	2F01h	02h
MODTYP	1	Module information	15h			03h
ERR_C	1	reserved	00h			04h
ERR_D	1	Diagnostic	00h			05h
CHTYP	1	Channel type	73h			06h
NUMBIT	1	Number diagnostic bits per channel	08h			07h
NUMCH	1	Number of channels of a module	02h			08h
CHERR	1	Channel error	00h			09h
CH0ERR	1	Channel-specific error channel 0	00h			0Ah

Name	Bytes	Function	Default	DS	IX	SX
CH1ERR	1	Channel-specific error channel 1	00h			0Bh
CH2ERR... CH7ERR	6	reserved	00h			0Ch ... 11h
DIAG_US	4	µs ticker	00h			13h

ERR_A Diagnostic

Byte	Bit 7 ... 0
0	<ul style="list-style-type: none"> ■ Bit 0: set at module failure ■ Bit 1: set at internal error ■ Bit 2: set at external error ■ Bit 3: set at channel error ■ Bit 4: set at external auxiliary supply missing ■ Bit 6 ... 5: reserved ■ Bit 7: set at error in parameterization

MODTYP Module information

Byte	Bit 7 ... 0
0	<ul style="list-style-type: none"> ■ Bit 3 ... 0: module class <ul style="list-style-type: none"> – 0101b analog module ■ Bit 4: set at channel information present ■ Bit 7 ... 5: reserved

ERR_D Diagnostic

Byte	Bit 7 ... 0
0	<ul style="list-style-type: none"> ■ Bit 2 ... 0: reserved ■ Bit 3: set at internal diagnostics buffer overflow ■ Bit 4: set at internal communication error ■ Bit 7 ... 5: reserved

CHTYP Channel type

Byte	Bit 7 ... 0
0	<ul style="list-style-type: none"> ■ Bit 6 ... 0: Channel type <ul style="list-style-type: none"> – 70h: Digital input – 71h: Analog input – 72h: Digital output – 73h: Analog output – 74h: Analog input/output – 76h: Counter ■ Bit 7: reserved

NUMBIT Diagnostic bits

Byte	Bit 7 ... 0
0	Number of diagnostic bits per channel (here 08h)

032-1CB30 - AO 2x16Bit 0...10V > Diagnostic data

NUMCH Channels

Byte	Bit 7 ... 0
0	Number of channels of a module (here 02h)

CHERR Channel error

Byte	Bit 7 ... 0
0	<ul style="list-style-type: none"> ■ Bit 0: set at error in channel group 0 ■ Bit 1: set at error in channel group 1 ■ Bit 7 ... 2: reserved

**CH0ERR / CH1ERR
Channel specific**

Byte	Bit 7 ... 0
0	Channel-specific error channel x: <ul style="list-style-type: none"> ■ Bit 0: set at configuring/parameter assignment error ■ Bit 2 ... 1: reserved ■ Bit 3: set at short-circuit to ground ■ Bit 7 ... 4: reserved

**CH2ERR ... CH7ERR
reserved**

Byte	Bit 7 ... 0
0	reserved

DIAG_US μ s ticker

Byte	Bit 7 ... 0
0...3	Value of the μ s ticker at the moment of the diagnostic

 μ s ticker

In the System SLIO module there is a timer (μ s ticker). With PowerON the timer starts counting with 0. After $2^{32}-1\mu$ s the timer starts with 0 again.

4.11 032-1CB40 - AO 2x16Bit 0(4)...20mA

Properties

The electronic module has 2 outputs with parameterizable functions. The channels of the module are electrically isolated from the backplane bus. In addition, the channels are isolated to the DC 24V power supply by means of DC/DC converter.

- 2 analog outputs
- Suited for sensors with 0 ... 20mA; 4 ... 20mA
- Diagnostics function
- 16bit resolution

Structure

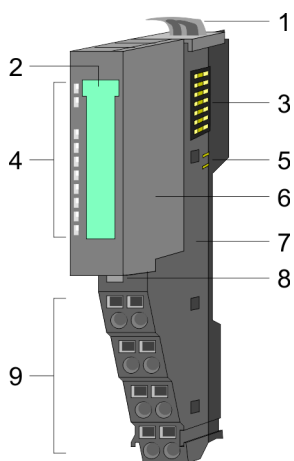

- 1 Locking lever terminal module
- 2 Labeling strip
- 3 Backplane bus
- 4 LED status indication
- 5 DC 24V power section supply
- 6 Electronic module
- 7 Terminal module
- 8 Locking lever electronic module
- 9 Terminal

Status indication

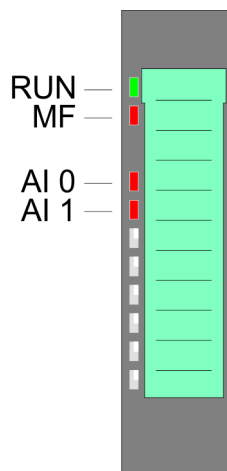

RUN	MF	AO x	Description
<input checked="" type="checkbox"/> green	<input checked="" type="checkbox"/> red	<input checked="" type="checkbox"/> red	
<input checked="" type="checkbox"/>	<input type="checkbox"/>	X	Bus communication is OK Module status is OK
<input checked="" type="checkbox"/>	<input checked="" type="checkbox"/>	X	Bus communication is OK Module status reports an error
<input type="checkbox"/>	<input checked="" type="checkbox"/>	X	Bus communication is not possible Module status reports an error
<input type="checkbox"/>	<input type="checkbox"/>	X	Error at bus power supply
X	<input checked="" type="checkbox"/> 2Hz	X	Error in configuration ↗ <i>Chap. 2.8 'Trouble shooting - LEDs' page 30</i>
<input checked="" type="checkbox"/>	<input type="checkbox"/>	<input checked="" type="checkbox"/>	Error channel x <ul style="list-style-type: none"> ■ Error in parameterization ■ Wire break (if parameterized)
not relevant: X			

Pin assignment

For wires with a cross section of 0.08mm² up to 1.5mm².

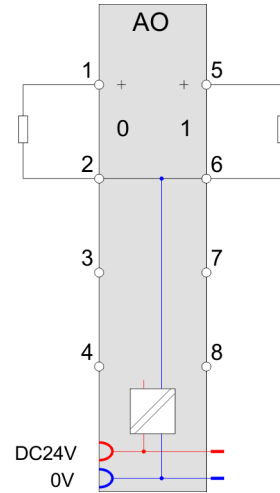
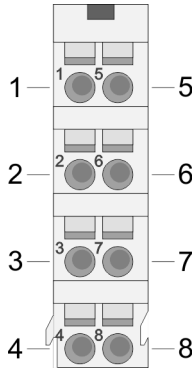

Pos.	Function	Type	Description
1	AO 0	O	Channel 0
2	AGND	O	Ground channels
3	---	---	not connected
4	---	---	not connected
5	AO 1	O	Channel 1
6	AGND	O	Ground channels
7	---	---	not connected
8	---	---	not connected

O: Output

Input area

No byte of the input area is used by the module.

Output area

At CPU, PROFIBUS and PROFINET the output area is embedded to the corresponding address area.

IX - Index for access via CANopen with s = Subindex, depends on number and type of analog modules

SX - Subindex for access via EtherCAT with Index 7000h + EtherCAT-Slot

More can be found in the according manual of your bus coupler.

Addr.	Name	Bytes	Function	IX	SX
+0	AO 0	2	Analog value channel 0	6411h/s	01h
+2	AO 1	2	Analog value channel 1	6411h/s+1	02h

4.11.1 Technical data

Order no.	032-1CB40
Type	SM 032
Module ID	050B 25D8
Current consumption/power loss	
Current consumption from backplane bus	60 mA
Current consumption from load voltage L+ (without load)	15 mA
Power loss	0.7 W
Technical data analog outputs	
Number of outputs	2
Cable length, shielded	200 m
Rated load voltage	DC 24 V
Reverse polarity protection of rated load voltage	✓
Current consumption from rated load voltage	-
Voltage output short-circuit protection	-
Voltage outputs	-
Min. load resistance (voltage range)	-
Max. capacitive load (current range)	-
Max. inductive load (current range)	-
Output voltage ranges	-
Operational limit of voltage ranges	-
Basic error limit voltage ranges	-
Destruction limit against external applied voltage	-
Current outputs	✓
Max. in load resistance (current range)	350 Ω
Max. inductive load (current range)	10 mH
Typ. open circuit voltage current output	12 V
Output current ranges	0 mA ... +20 mA +4 mA ... +20 mA
Operational limit of current ranges	+/-0.2%
Basic error limit current ranges	+/-0.1%
Destruction limit against external applied voltage	max. 12V (30V for 1s)
Settling time for ohmic load	0.25 ms
Settling time for capacitive load	-
Settling time for inductive load	1.5 ms
Resolution in bit	16
Conversion time	400 μs all channels

032-1CB40 - AO 2x16Bit 0(4)...20mA > Technical data

Order no.	032-1CB40
Substitute value can be applied	no
Output data size	4 Byte
Status information, alarms, diagnostics	
Status display	yes
Interrupts	no
Process alarm	no
Diagnostic interrupt	no
Diagnostic functions	yes
Diagnostics information read-out	possible
Supply voltage display	green LED
Group error display	red LED
Channel error display	red LED per channel
Isolation	
Between channels	-
Between channels of groups to	-
Between channels and backplane bus	✓
Between channels and power supply	✓
Max. potential difference between circuits	-
Max. potential difference between inputs (U _{cm})	-
Max. potential difference between Mana and Mintern (U _{iso})	DC 75 V/ AC 50 V
Max. potential difference between inputs and Mana (U _{cm})	-
Max. potential difference between inputs and Mintern (U _{iso})	-
Max. potential difference between Mintern and outputs	-
Insulation tested with	DC 500 V
Datasizes	
Input bytes	0
Output bytes	4
Parameter bytes	8
Diagnostic bytes	20
Housing	
Material	PPE / PPE GF10
Mounting	Profile rail 35 mm
Mechanical data	
Dimensions (WxHxD)	12.9 mm x 109 mm x 76.5 mm
Net weight	61 g

Order no.	032-1CB40
Weight including accessories	61 g
Gross weight	75 g
Environmental conditions	
Operating temperature	0 °C to 60 °C
Storage temperature	-25 °C to 70 °C
Certifications	
UL certification	yes
KC certification	yes

4.11.2 Parameter data

DS - Record set for access via CPU, PROFIBUS and PROFINET

IX - Index for access via CANopen

SX - Subindex for access via EtherCAT with Index 3100h + EtherCAT-Slot

More can be found in the according manual of your bus coupler.

Name	Bytes	Function	Default	DS	IX	SX
RES0	1	reserved	00h	00h	3100h	01h
WIBRK_EN	1	Wire-break recognition	00h	00h	3101h	02h
CH0FN	1	Function number channel 0	31h	80h	3102h	03h
CH1FN	1	Function number channel 1	31h	81h	3103h	04h

WIBRK_EN Wire-break recognition

Byte	Bit 7 ... 0
0	<ul style="list-style-type: none"> ■ Bit 0: Wire-break recognition channel 0 (1: on) ■ Bit 1: Wire-break recognition channel 1 (1: on) ■ Bit 7 ... 2: reserved



Please consider with enabled wire break recognition with the output range 0 ... 20mA, when the current goes below of 40µA (100 Digits), this can may lead to sporadic wire break messages!

CHxFN Function number channel x

In the following there are the measuring ranges with corresponding function number listed, which were supported by the analog module. With FFh the corresponding channel is deactivated. The formulas listed here allow you to transform an evaluated measuring value (digital value) to a value assigned to the measuring range (analog value) and vice versa.

0 ... 20mA

Output range (funct. no.)	Current (I)	Decimal (D)	Hex	Range	Formulas
0 ... 20mA Siemens S7 format (31h)	23.52mA	32511	7EFFh	overrange	$I = D \times \frac{20}{27648}$ $D = 27648 \times \frac{I}{20}$
	20mA	27648	6C00h	nominal range	
	10mA	13824	3600h		
	0mA	0	0000h		
	Not possible, is limited to 0mA.				
0 ... 20mA Siemens S5 format (41h)	25.00mA	20480	5000h	overrange	$I = D \times \frac{20}{16384}$ $D = 16384 \times \frac{I}{20}$
	20mA	16384	4000h	nominal range	
	10mA	8192	2000h		
	0mA	0	0000h		
	Not possible, is limited to 0mA.				

4 ... 20mA

Output range (funct. no.)	Current (I)	Decimal (D)	Hex	Range	Formulas
4 ... 20mA Siemens S7 format (30h)	22.81mA	32511	7EFFh	overrange	$I = D \times \frac{16}{27648} + 4$ $D = 27648 \times \frac{I-4}{16}$
	20mA	27648	6C00h	nominal range	
	12mA	13824	3600h		
	4mA	0	0000h		
	0mA	-6912	E500h	underrange	
4 ... 20mA Siemens S5 format (40h)	24.00mA	20480	5000h	overrange	$I = D \times \frac{16}{16384} + 4$ $D = 16384 \times \frac{I-4}{16}$
	20mA	16384	4000h	nominal range	
	12mA	8192	2000h		
	4mA	0	0000h		
	0mA	-4096	F000h	underrange	

4.11.3 Diagnostic data

So this module does not support diagnostic interrupt functions, the diagnostics data serve for information about this module. On error the corresponding channel LED of the module is activated and the error is registered in the diagnostics data.

The following errors are listed in the diagnostics data:

- Error in project engineering / parameterization
- Wire-break (if parameterized)

DS - Record set for access via CPU, PROFIBUS and PROFINET. The access happens by DS 01h. Additionally the first 4 bytes may be accessed by DS 00h.

IX - Index for access via CANopen. The access happens by IX 2F01h. Additionally the first 4 bytes may be accessed by IX 2F00h.

SX - Subindex for access via EtherCAT with Index 5005h.

More can be found in the according manual of your bus coupler.

Name	Bytes	Function	Default	DS	IX	SX
ERR_A	1	Diagnostic	00h	01h	2F01h	02h
MODTYP	1	Module information	15h			03h
ERR_C	1	reserved	00h			04h
ERR_D	1	Diagnostic	00h			05h
CHTYP	1	Channel type	73h			06h
NUMBIT	1	Number diagnostic bits per channel	08h			07h
NUMCH	1	Number of channels of a module	02h			08h
CHERR	1	Channel error	00h			09h
CH0ERR	1	Channel-specific error channel 0	00h			0Ah
CH1ERR	1	Channel-specific error channel 1	00h			0Bh
CH2ERR... CH7ERR	6	reserved	00h			0Ch ... 11h
DIAG_US	4	µs ticker	00h			13h

ERR_A Diagnostic

Byte	Bit 7 ... 0
0	<ul style="list-style-type: none"> ■ Bit 0: set at module failure ■ Bit 1: set at internal error ■ Bit 2: set at external error ■ Bit 3: set at channel error ■ Bit 4: set at external auxiliary supply missing ■ Bit 6 ... 5: reserved ■ Bit 7: set at error in parameterization

032-1CB40 - AO 2x16Bit 0(4)...20mA > Diagnostic data

MODTYP Module information

Byte	Bit 7 ... 0
0	<ul style="list-style-type: none"> ■ Bit 3 ... 0: module class <ul style="list-style-type: none"> – 0101b analog module ■ Bit 4: set at channel information present ■ Bit 7 ... 5: reserved

ERR_D Diagnostic

Byte	Bit 7 ... 0
0	<ul style="list-style-type: none"> ■ Bit 2 ... 0: reserved ■ Bit 3: set at internal diagnostics buffer overflow ■ Bit 4: set at internal communication error ■ Bit 7 ... 5: reserved

CHTYP Channel type

Byte	Bit 7 ... 0
0	<ul style="list-style-type: none"> ■ Bit 6 ... 0: Channel type <ul style="list-style-type: none"> – 70h: Digital input – 71h: Analog input – 72h: Digital output – 73h: Analog output – 74h: Analog input/output – 76h: Counter ■ Bit 7: reserved

NUMBIT Diagnostic bits

Byte	Bit 7 ... 0
0	Number of diagnostic bits per channel (here 08h)

NUMCH Channels

Byte	Bit 7 ... 0
0	Number of channels of a module (here 02h)

CHERR Channel error

Byte	Bit 7 ... 0
0	<ul style="list-style-type: none"> ■ Bit 0: set at error in channel group 0 ■ Bit 1: set at error in channel group 1 ■ Bit 7 ... 2: reserved

CH0ERR / CH1ERR Channel-specific

Byte	Bit 7 ... 0
0	Channel-specific error channel x <ul style="list-style-type: none"> ■ Bit 0: set at configuring/parameter assignment error ■ Bit 3 ... 1: reserved ■ Bit 4: set at wire-break ■ Bit 7 ... 5: reserved

**CH2ERR ... CH7ERR
reserved**

Byte	Bit 7 ... 0
0	reserved

DIAG_US μ s ticker

Byte	Bit 7 ... 0
0...3	Value of the μ s ticker at the moment of the diagnostic

 μ s ticker

In the System SLIO module there is a timer (μ s ticker). With PowerON the timer starts counting with 0. After $2^{32}-1\mu$ s the timer starts with 0 again.

4.12 032-1CB70 - AO 2x16Bit ±10V

Properties

The electronic module has 2 outputs with parameterizable functions. The channels of the module are electrically isolated from the backplane bus. In addition, the channels are isolated to the DC 24V power supply by means of DC/DC converter.

- 2 analog outputs
- Suited for sensors with ±10V, 0 ... 10V
- Diagnostics function
- 16bit resolution

Structure

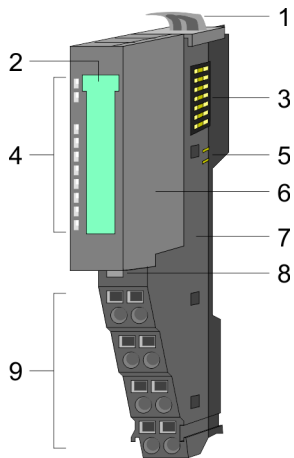

- 1 Locking lever terminal module
- 2 Labeling strip
- 3 Backplane bus
- 4 LED status indication
- 5 DC 24V power section supply
- 6 Electronic module
- 7 Terminal module
- 8 Locking lever electronic module
- 9 Terminal

Status indication

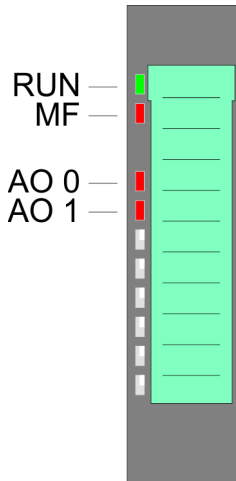

RUN	MF	AO x	Description
■ green	■ red	■ red	
■	<input type="checkbox"/>	X	Bus communication is OK Module status is OK
■	■	X	Bus communication is OK Module status reports an error
<input type="checkbox"/>	■	X	Bus communication is not possible Module status reports an error
<input type="checkbox"/>	<input type="checkbox"/>	X	Error at bus power supply
X	▬ 2Hz	X	Error in configuration ↗ <i>Chap. 2.8 'Trouble shooting - LEDs' page 30</i>
■	<input type="checkbox"/>	■	Error channel x <ul style="list-style-type: none"> ■ Overload, short-circuit ■ Error in parameterization
not relevant: X			

Pin assignment

For wires with a cross section of 0.08mm² up to 1.5mm².

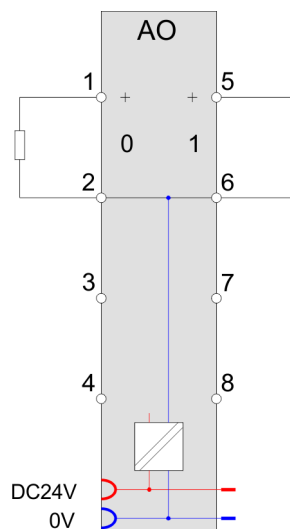
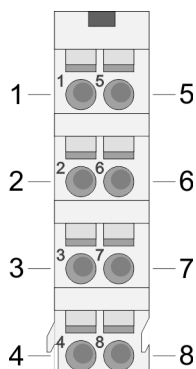

Pos.	Function	Type	Description
1	AO 0	O	Channel 0
2	AGND	O	Ground channels
3	---	---	not connected
4	---	---	not connected
5	AO 1	O	Channel 1
6	AGND	O	Ground channels
7	---	---	not connected
8	---	---	not connected

O: Output

Input area

No byte of the input area is used by the module.

Output area

At CPU, PROFIBUS and PROFINET the output area is embedded to the corresponding address area.

IX - Index for access via CANopen with s = Subindex, depends on number and type of analog modules

SX - Subindex for access via EtherCAT with Index 7000h + EtherCAT-Slot

More can be found in the according manual of your bus coupler.

Addr.	Name	Bytes	Function	IX	SX
+0	AO 0	2	Analog value channel 0	6411h/s	01h
+2	AO 1	2	Analog value channel 1	6411h/s+1	02h

4.12.1 Technical data

Order no.	032-1CB70
Type	SM 032
Module ID	0508 2558
Current consumption/power loss	
Current consumption from backplane bus	60 mA
Current consumption from load voltage L+ (without load)	20 mA
Power loss	0.8 W
Technical data analog outputs	
Number of outputs	2
Cable length, shielded	200 m
Rated load voltage	DC 24 V
Reverse polarity protection of rated load voltage	✓
Current consumption from rated load voltage	-
Voltage output short-circuit protection	✓
Voltage outputs	✓
Min. load resistance (voltage range)	5 k Ω
Max. capacitive load (current range)	1 μ F
Max. inductive load (current range)	10 mA
Output voltage ranges	-10 V ... +10 V 0 V ... +10 V
Operational limit of voltage ranges	+/-0.2%
Basic error limit voltage ranges	+/-0.1%
Destruction limit against external applied voltage	max. 24V
Current outputs	-
Max. in load resistance (current range)	-
Max. inductive load (current range)	-
Typ. open circuit voltage current output	-
Output current ranges	-
Operational limit of current ranges	-
Basic error limit current ranges	-
Destruction limit against external applied voltage	-
Settling time for ohmic load	300 μ s
Settling time for capacitive load	3 ms
Settling time for inductive load	-
Resolution in bit	16
Conversion time	200 μ s all channels

Order no.	032-1CB70
Substitute value can be applied	no
Output data size	4 Byte
Status information, alarms, diagnostics	
Status display	yes
Interrupts	no
Process alarm	no
Diagnostic interrupt	no
Diagnostic functions	yes
Diagnostics information read-out	possible
Supply voltage display	green LED
Group error display	red LED
Channel error display	red LED per channel
Isolation	
Between channels	-
Between channels of groups to	-
Between channels and backplane bus	✓
Between channels and power supply	✓
Max. potential difference between circuits	-
Max. potential difference between inputs (U _{cm})	-
Max. potential difference between Mana and Mintern (U _{iso})	DC 75 V/ AC 50 V
Max. potential difference between inputs and Mana (U _{cm})	-
Max. potential difference between inputs and Mintern (U _{iso})	-
Max. potential difference between Mintern and outputs	-
Insulation tested with	DC 500 V
Datasizes	
Input bytes	0
Output bytes	4
Parameter bytes	8
Diagnostic bytes	20
Housing	
Material	PPE / PPE GF10
Mounting	Profile rail 35 mm
Mechanical data	
Dimensions (WxHxD)	12.9 mm x 109 mm x 76.5 mm
Net weight	60 g

032-1CB70 - AO 2x16Bit ±10V > Parameter data

Order no.	032-1CB70
Weight including accessories	60 g
Gross weight	75 g
Environmental conditions	
Operating temperature	0 °C to 60 °C
Storage temperature	-25 °C to 70 °C
Certifications	
UL certification	yes
KC certification	yes

4.12.2 Parameter data

DS - Record set for access via CPU, PROFIBUS and PROFINET

IX - Index for access via CANopen

SX - Subindex for access via EtherCAT with Index 3100h + EtherCAT-Slot

More can be found in the according manual of your bus coupler.

Name	Bytes	Function	Default	DS	IX	SX
RES0	1	reserved	00h	00h	3100h	01h
SHORT_EN	1	Short-circuit recognition	00h	00h	3101h	02h
CH0FN	1	Function number channel 0	12h	80h	3102h	03h
CH1FN	1	Function number channel 1	12h	81h	3103h	04h

SHORT_EN Short-circuit recognition

Byte	Bit 7 ... 0
0	<ul style="list-style-type: none"> ■ Bit 0: Short-circuit recognition channel 0 (1:on) ■ Bit 1: Short-circuit recognition channel 1 (1:on) ■ Bit 7 ... 2: reserved

CHxFN Function number channel x

In the following there are the measuring ranges with corresponding function number listed, which were supported by the analog module. With FFh the corresponding channel is deactivated. The formulas listed here allow you to transform an evaluated measuring value (digital value) to a value assigned to the measuring range (analog value) and vice versa.

±10V

Output range (funct. no.)	Voltage (U)	Decimal (D)	Hex	Range	Formulas
±10V Siemens S format (12h)	11.76V	32511	7EFFh	overrange	$U = D \times \frac{10}{27648}$ $D = 27648 \times \frac{U}{10}$
	10V	27648	6C00h	nominal range	
	5V	13824	3600h		
	0V	0	0000h		
	-5V	-13824	CA00h		
	-10V	-27648	9400h	underrange	
	-11.76V	-32512	8100h		
±10V Siemens S5 format (22h)	12.5V	20480	5000h	overrange	$U = D \times \frac{10}{16384}$ $D = 16384 \times \frac{U}{10}$
	10V	16384	4000h	nominal range	
	5V	8192	2000h		
	0V	0	0000h		
	-5V	-8192	E000h		
	-10V	-16384	C000h		
	-12.5V	-20480	B000h	underrange	

0 ... 10V

Output range (funct. no.)	Voltage (U)	Decimal (D)	Hex	Range	Formulas
0 ... 10V Siemens S7 format (10h)	11.76V	32511	7EFFh	overrange	$U = D \times \frac{10}{27648}$ $D = 27648 \times \frac{U}{10}$
	10V	27648	6C00h	nominal range	
	5V	13824	3600h		
	0V	0	0000h		
	Not possible, is limited to 0V.				
0 ... 10V Siemens S5 format (20h)	12.5V	20480	5000h	overrange	$U = D \times \frac{10}{16384}$ $D = 16384 \times \frac{U}{10}$
	10V	16384	4000h	nominal range	
	5V	8192	2000h		
	0V	0	0000h		
	Not possible, is limited to 0V.				

4.12.3 Diagnostic data

So this module does not support diagnostic interrupt functions, the diagnostics data serve for information about this module. On error the corresponding channel LED of the module is activated and the error is registered in the diagnostics data.

The following errors are listed in the diagnostics data:

- Error in project engineering / parameterization
- Short-circuit/overload (if parameterized)

DS - Record set for access via CPU, PROFIBUS and PROFINET. The access happens by DS 01h. Additionally the first 4 bytes may be accessed by DS 00h.

IX - Index for access via CANopen. The access happens by IX 2F01h. Additionally the first 4 bytes may be accessed by IX 2F00h.

SX - Subindex for access via EtherCAT with Index 5005h.

More can be found in the according manual of your bus coupler.

Name	Bytes	Function	Default	DS	IX	SX
ERR_A	1	Diagnostic	00h	01h	2F01h	02h
MODTYP	1	Module information	15h			03h
ERR_C	1	reserved	00h			04h
ERR_D	1	Diagnostic	00h			05h
CHTYP	1	Channel type	73h			06h
NUMBIT	1	Number diagnostic bits per channel	08h			07h
NUMCH	1	Number of channels of a module	02h			08h
CHERR	1	Channel error	00h			09h
CH0ERR	1	Channel-specific error channel 0	00h			0Ah
CH1ERR	1	Channel-specific error channel 1	00h			0Bh
CH2ERR... CH7ERR	6	reserved	00h			0Ch ... 11h
DIAG_US	4	µs ticker	00h			13h

ERR_A Diagnostic

Byte	Bit 7 ... 0
0	<ul style="list-style-type: none"> ■ Bit 0: set at module failure ■ Bit 1: set at internal error ■ Bit 2: set at external error ■ Bit 3: set at channel error ■ Bit 4: set at external auxiliary supply missing ■ Bit 6 ... 5: reserved ■ Bit 7: set at error in parameterization

MODTYP Module information

Byte	Bit 7 ... 0
0	<ul style="list-style-type: none"> ■ Bit 3 ... 0: module class <ul style="list-style-type: none"> – 0101b analog module ■ Bit 4: set at channel information present ■ Bit 7 ... 5: reserved

ERR_D Diagnostic

Byte	Bit 7 ... 0
0	<ul style="list-style-type: none"> ■ Bit 2 ... 0: reserved ■ Bit 3: set at internal diagnostics buffer overflow ■ Bit 4: set at internal communication error ■ Bit 7 ... 5: reserved

CHTYP Channel type

Byte	Bit 7 ... 0
0	<ul style="list-style-type: none"> ■ Bit 6 ... 0: Channel type <ul style="list-style-type: none"> – 70h: Digital input – 71h: Analog input – 72h: Digital output – 73h: Analog output – 74h: Analog input/output – 76h: Counter ■ Bit 7: reserved

NUMBIT Diagnostic bits

Byte	Bit 7 ... 0
0	Number of diagnostic bits per channel (here 08h)

NUMCH Channels

Byte	Bit 7 ... 0
0	Number of channels of a module (here 02h)

CHERR Channel error

Byte	Bit 7 ... 0
0	<ul style="list-style-type: none"> ■ Bit 0: set at error in channel group 0 ■ Bit 1: set at error in channel group 1 ■ Bit 7 ... 2: reserved

CH0ERR / CH1ERR Channel-specific

Byte	Bit 7 ... 0
0	Channel-specific error channel x: <ul style="list-style-type: none"> ■ Bit 0: set at configuring/parameter assignment error ■ Bit 2 ... 1: reserved ■ Bit 3: set at short-circuit to ground ■ Bit 7 ... 4: reserved

032-1CB70 - AO 2x16Bit $\pm 10V$ > Diagnostic data

CH2ERR ... CH7ERR
reserved

Byte	Bit 7 ... 0
0	reserved

DIAG_US μs ticker

Byte	Bit 7 ... 0
0...3	Value of the μs ticker at the moment of the diagnostic

μs ticker

In the System SLIO module there is a timer (μs ticker). With PowerON the timer starts counting with 0. After $2^{32}-1\mu s$ the timer starts with 0 again.

4.13 032-1CD30 - AO 4x16Bit 0...10V

Properties

The electronic module has 4 outputs with parameterizable functions. The channels of the module are electrically isolated from the backplane bus. In addition, the channels are isolated to the DC 24V power supply by means of DC/DC converter.

- 4 analog outputs
- Suited for sensors with 0 ... 10V
- Diagnostics function
- 16bit resolution

Structure

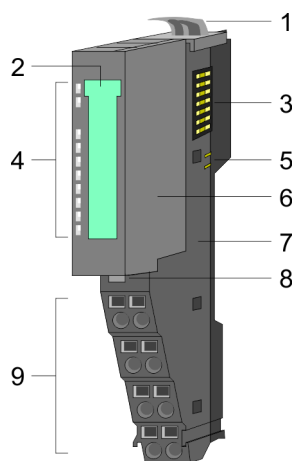

- 1 Locking lever terminal module
- 2 Labeling strip
- 3 Backplane bus
- 4 LED status indication
- 5 DC 24V power section supply
- 6 Electronic module
- 7 Terminal module
- 8 Locking lever electronic module
- 9 Terminal

Status indication

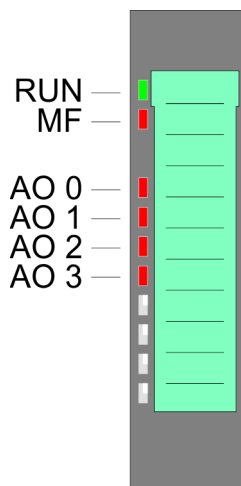

RUN	MF	AO x	Description
<input checked="" type="checkbox"/> green	<input checked="" type="checkbox"/> red	<input checked="" type="checkbox"/> red	
<input checked="" type="checkbox"/>	<input type="checkbox"/>	X	Bus communication is OK Module status is OK
<input checked="" type="checkbox"/>	<input checked="" type="checkbox"/>	X	Bus communication is OK Module status reports an error
<input type="checkbox"/>	<input checked="" type="checkbox"/>	X	Bus communication is not possible Module status reports an error
<input type="checkbox"/>	<input type="checkbox"/>	X	Error at bus power supply
X	<input checked="" type="checkbox"/> 2Hz	X	Error in configuration ↗ <i>Chap. 2.8 'Trouble shooting - LEDs' page 30</i>
<input checked="" type="checkbox"/>	<input type="checkbox"/>	<input checked="" type="checkbox"/>	Error channel x <ul style="list-style-type: none"> ■ Overload, short-circuit ■ Error in parameterization
not relevant: X			

Pin assignment

For wires with a cross section of 0.08mm² up to 1.5mm².

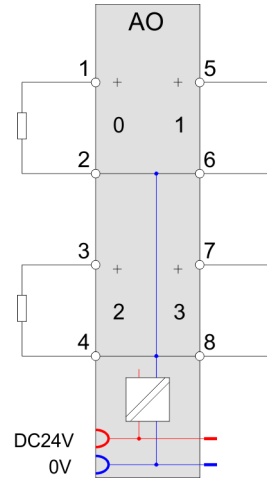
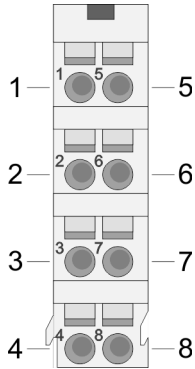

Pos.	Function	Type	Description
1	AO 0	O	Channel 0
2	AGND	O	Ground channels
3	AO 2	O	Channel 2
4	AGND	O	Ground channels
5	AO 1	O	Channel 1
6	AGND	O	Ground channels
7	AO 3	O	Channel 3
8	AGND	O	Ground channels

O: Output

Input area

No byte of the input area is used by the module.

Output area

At CPU, PROFIBUS and PROFINET the output area is embedded to the corresponding address area.

IX - Index for access via CANopen with s = Subindex, depends on number and type of analog modules

SX - Subindex for access via EtherCAT with Index 7000h + EtherCAT-Slot

More can be found in the according manual of your bus coupler.

Addr.	Name	Bytes	Function	IX	SX
+0	AO 0	2	Analog value channel 0	6411h/s	01h
+2	AO 1	2	Analog value channel 1	6411h/s+1	02h
+4	AO 2	2	Analog value channel 2	6411h/s+2	03h
+6	AO 3	2	Analog value channel 3	6411h/s+3	04h

4.13.1 Technical data

Order no.	032-1CD30
Type	SM 032
Module ID	0509 2560
Current consumption/power loss	
Current consumption from backplane bus	65 mA
Current consumption from load voltage L+ (without load)	20 mA
Power loss	0.8 W
Technical data analog outputs	
Number of outputs	4
Cable length, shielded	200 m
Rated load voltage	DC 24 V
Reverse polarity protection of rated load voltage	✓
Current consumption from rated load voltage	-
Voltage output short-circuit protection	✓
Voltage outputs	✓
Min. load resistance (voltage range)	5 kΩ
Max. capacitive load (current range)	1 μF
Max. inductive load (current range)	10 mA
Output voltage ranges	0 V ... +10 V
Operational limit of voltage ranges	+/-0.2%
Basic error limit voltage ranges	+/-0.1%
Destruction limit against external applied voltage	max. 24V
Current outputs	-
Max. in load resistance (current range)	-
Max. inductive load (current range)	-
Typ. open circuit voltage current output	-
Output current ranges	-
Operational limit of current ranges	-
Basic error limit current ranges	-
Destruction limit against external applied voltage	-
Settling time for ohmic load	150 μs
Settling time for capacitive load	1 ms
Settling time for inductive load	-
Resolution in bit	16
Conversion time	200 μs all channels
Substitute value can be applied	no

032-1CD30 - AO 4x16Bit 0...10V > Technical data

Order no.	032-1CD30
Output data size	8 Byte
Status information, alarms, diagnostics	
Status display	yes
Interrupts	no
Process alarm	no
Diagnostic interrupt	no
Diagnostic functions	yes
Diagnostics information read-out	possible
Supply voltage display	green LED
Group error display	red LED
Channel error display	red LED per channel
Isolation	
Between channels	-
Between channels of groups to	-
Between channels and backplane bus	✓
Between channels and power supply	✓
Max. potential difference between circuits	-
Max. potential difference between inputs (U _{cm})	-
Max. potential difference between Mana and Mintern (U _{iso})	DC 75 V/ AC 50 V
Max. potential difference between inputs and Mana (U _{cm})	-
Max. potential difference between inputs and Mintern (U _{iso})	-
Max. potential difference between Mintern and outputs	-
Insulation tested with	DC 500 V
Datasizes	
Input bytes	0
Output bytes	8
Parameter bytes	10
Diagnostic bytes	20
Housing	
Material	PPE / PPE GF10
Mounting	Profile rail 35 mm
Mechanical data	
Dimensions (WxHxD)	12.9 mm x 109 mm x 76.5 mm
Net weight	60 g
Weight including accessories	60 g

Order no.	032-1CD30
Gross weight	75 g
Environmental conditions	
Operating temperature	0 °C to 60 °C
Storage temperature	-25 °C to 70 °C
Certifications	
UL certification	yes
KC certification	yes

4.13.2 Parameter data

DS - Record set for access via CPU, PROFIBUS and PROFINET

IX - Index for access via CANopen

SX - Subindex for access via EtherCAT with Index 3100h + EtherCAT-Slot

More can be found in the according manual of your bus coupler.

Name	Bytes	Function	Default	DS	IX	SX
RES0	1	reserved	00h	00h	3100h	01h
SHORT_EN	1	Short-circuit recognition	00h	00h	3101h	02h
CH0FN	1	Function number channel 0	10h	80h	3102h	03h
CH1FN	1	Function number channel 1	10h	81h	3103h	04h
CH2FN	1	Function number channel 2	10h	82h	3104h	05h
CH3FN	1	Function number channel 3	10h	83h	3105h	06h

SHORT_EN Short-circuit recognition

Byte	Bit 7 ... 0
0	<ul style="list-style-type: none"> ■ Bit 0: Short-circuit recognition channel 0 (1:on) ■ Bit 1: Short-circuit recognition channel 1 (1:on) ■ Bit 2: Short-circuit recognition channel 2 (1:on) ■ Bit 3: Short-circuit recognition channel 3 (1:on) ■ Bit 7 ... 4: reserved

CHxFN Function number channel x

In the following there are the measuring ranges with corresponding function number listed, which were supported by the analog module. With FFh the corresponding channel is deactivated. The formulas listed here allow you to transform an evaluated measuring value (digital value) to a value assigned to the measuring range (analog value) and vice versa.

0 ... 10V

Output range (funct. no.)	Voltage (U)	Decimal (D)	Hex	Range	Formulas
0 ... 10V Siemens S7 format (10h)	11,76V	32511	7EFFh	overrange	$U = D \times \frac{10}{27648}$ $D = 27648 \times \frac{U}{10}$
	10V	27648	6C00h	nominal range	
	5V	13824	3600h		
	0V	0	0000h		
	Not possible, is limited to 0V.				
0 ... 10V Siemens S5 format (20h)	12,5V	20480	5000h	overrange	$U = D \times \frac{10}{16384}$ $D = 16384 \times \frac{U}{10}$
	10V	16384	4000h	nominal range	
	5V	8192	2000h		
	0V	0	0000h		
	Not possible, is limited to 0V.				

4.13.3 Diagnostic data

So this module does not support diagnostic interrupt functions, the diagnostics data serve for information about this module. On error the corresponding channel LED of the module is activated and the error is registered in the diagnostics data.

The following errors are listed in the diagnostics data:

- Error in project engineering / parameterization
- Short-circuit/overload (if parameterized)

DS - Record set for access via CPU, PROFIBUS and PROFINET. The access happens by DS 01h. Additionally the first 4 bytes may be accessed by DS 00h.

IX - Index for access via CANopen. The access happens by IX 2F01h. Additionally the first 4 bytes may be accessed by IX 2F00h.

SX - Subindex for access via EtherCAT with Index 5005h.

More can be found in the according manual of your bus coupler.

Name	Bytes	Function	Default	DS	IX	SX
ERR_A	1	Diagnostic	00h	01h	2F01h	02h
MODTYP	1	Module information	15h			03h
ERR_C	1	reserved	00h			04h
ERR_D	1	Diagnostic	00h			05h
CHTYP	1	Channel type	73h			06h
NUMBIT	1	Number diagnostic bits per channel	08h			07h
NUMCH	1	Number of channels of a module	04h			08h
CHERR	1	Channel error	00h			09h
CH0ERR	1	Channel-specific error channel 0	00h			0Ah

Name	Bytes	Function	Default	DS	IX	SX
CH1ERR	1	Channel-specific error channel 1	00h			0Bh
CH2ERR	1	Channel-specific error channel 2	00h			0Ch
CH3ERR	1	Channel-specific error channel 3	00h			0Dh
CH4ERR... CH7ERR	4	reserved	00h			0Eh ... 11h
DIAG_US	4	µs ticker	00h			13h

ERR_A Diagnostic

Byte	Bit 7 ... 0
0	<ul style="list-style-type: none"> ■ Bit 0: set at module failure ■ Bit 1: set at internal error ■ Bit 2: set at external error ■ Bit 3: set at channel error ■ Bit 4: set at external auxiliary supply missing ■ Bit 6 ... 5: reserved ■ Bit 7: set at error in parameterization

MODTYP Module information

Byte	Bit 7 ... 0
0	<ul style="list-style-type: none"> ■ Bit 3 ... 0: module class <ul style="list-style-type: none"> – 0101b analog module ■ Bit 4: set at channel information present ■ Bit 7 ... 5: reserved

ERR_D Diagnostic

Byte	Bit 7 ... 0
0	<ul style="list-style-type: none"> ■ Bit 2 ... 0: reserved ■ Bit 3: set at internal diagnostics buffer overflow ■ Bit 4: set at internal communication error ■ Bit 7 ... 5: reserved

CHTYP Channel type

Byte	Bit 7 ... 0
0	<ul style="list-style-type: none"> ■ Bit 6 ... 0: Channel type <ul style="list-style-type: none"> – 70h: Digital input – 71h: Analog input – 72h: Digital output – 73h: Analog output – 74h: Analog input/-output – 76h: Counter ■ Bit 7: reserved

NUMBIT Diagnostic bits

Byte	Bit 7 ... 0
0	Number of diagnostic bits per channel (here 08h)

032-1CD30 - AO 4x16Bit 0...10V > Diagnostic data

NUMCH Channels

Byte	Bit 7 ... 0
0	Number of channels of a module (here 04h)

CHERR Channel error

Byte	Bit 7 ... 0
0	<ul style="list-style-type: none"> ■ Bit 0: set at error in channel group 0 ■ Bit 1: set at error in channel group 1 ■ Bit 2: set at error in channel group 2 ■ Bit 3: set at error in channel group 3 ■ Bit 7 ... 4: reserved

**CH0ERR ... CH3ERR
Channel-specific**

Byte	Bit 7 ... 0
0	Channel-specific error channel x: <ul style="list-style-type: none"> ■ Bit 0: set at configuring/parameter assignment error ■ Bit 2 ... 1: reserved ■ Bit 3: set at short-circuit to ground ■ Bit 7 ... 4: reserved

**CH4ERR ... CH7ERR
reserved**

Byte	Bit 7 ... 0
0	reserved

DIAG_US μ s ticker

Byte	Bit 7 ... 0
0...3	Value of the μ s ticker at the moment of the diagnostic

 μ s ticker

In the System SLIO module there is a timer (μ s ticker). With PowerON the timer starts counting with 0. After $2^{32}-1\mu$ s the timer starts with 0 again.

4.14 032-1CD40 - AO 4x16Bit 0(4)...20mA

Properties

The electronic module has 4 outputs with parameterizable functions. The channels of the module are electrically isolated from the backplane bus. In addition, the channels are isolated to the DC 24V power supply by means of DC/DC converter.

- 4 analog outputs
- Suited for sensors with 0...20mA; 4...20mA
- Diagnostics function
- 16bit resolution

Structure

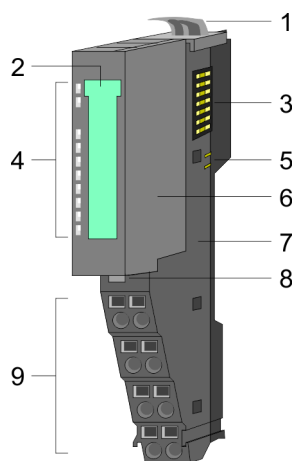

- 1 Locking lever terminal module
- 2 Labeling strip
- 3 Backplane bus
- 4 LED status indication
- 5 DC 24V power section supply
- 6 Electronic module
- 7 Terminal module
- 8 Locking lever electronic module
- 9 Terminal

Status indication

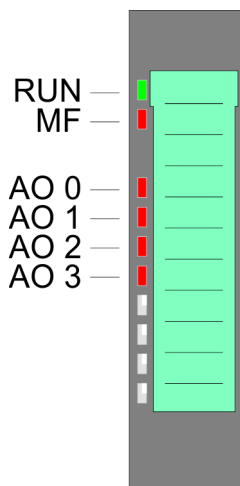

RUN	MF	AO x	Description
<input checked="" type="checkbox"/> green	<input checked="" type="checkbox"/> red	<input checked="" type="checkbox"/> red	
<input checked="" type="checkbox"/>	<input type="checkbox"/>	X	Bus communication is OK Module status is OK
<input checked="" type="checkbox"/>	<input checked="" type="checkbox"/>	X	Bus communication is OK Module status reports an error
<input type="checkbox"/>	<input checked="" type="checkbox"/>	X	Bus communication is not possible Module status reports an error
<input type="checkbox"/>	<input type="checkbox"/>	X	Error at bus power supply
X	<input checked="" type="checkbox"/> 2Hz	X	Error in configuration ↗ <i>Chap. 2.8 'Trouble shooting - LEDs' page 30</i>
<input checked="" type="checkbox"/>	<input type="checkbox"/>	<input checked="" type="checkbox"/>	Error channel x <ul style="list-style-type: none"> ■ Error in parameterization ■ Wire break (if parameterized)
not relevant: X			

032-1CD40 - AO 4x16Bit 0(4)...20mA

Pin assignment

For wires with a cross section of 0.08mm² up to 1.5mm².

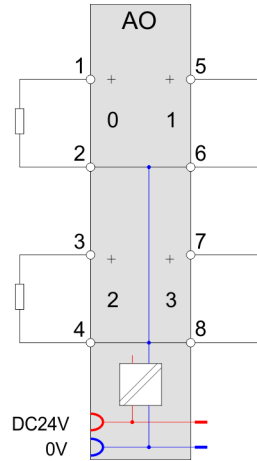
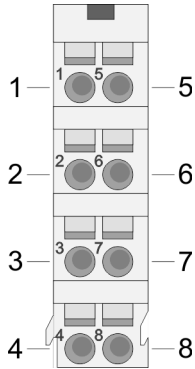

Pos.	Function	Type	Description
1	AO 0	O	Channel 0
2	AGND	O	Ground channels
3	AO 2	O	Channel 2
4	AGND	O	Ground channels
5	AO 1	O	Channel 1
6	AGND	O	Ground channels
7	AO 3	O	Channel 3
8	AGND	O	Ground channels

O: Output

Input area

No byte of the input area is used by the module.

Output area

At CPU, PROFIBUS and PROFINET the output area is embedded to the corresponding address area.

IX - Index for access via CANopen with s = Subindex, depends on number and type of analog modules

SX - Subindex for access via EtherCAT with Index 7000h + EtherCAT-Slot

More can be found in the according manual of your bus coupler.

Addr.	Name	Bytes	Function	IX	SX
+0	AO 0	2	Analog value channel 0	6411h/s	01h
+2	AO 1	2	Analog value channel 1	6411h/s+1	02h
+4	AO 2	2	Analog value channel 2	6411h/s+2	03h
+6	AO 3	2	Analog value channel 3	6411h/s+3	04h

4.14.1 Technical data

Order no.	032-1CD40
Type	SM 032
Module ID	050C 25E0
Current consumption/power loss	
Current consumption from backplane bus	65 mA
Current consumption from load voltage L+ (without load)	20 mA
Power loss	0.8 W
Technical data analog outputs	
Number of outputs	4
Cable length, shielded	200 m
Rated load voltage	DC 24 V
Reverse polarity protection of rated load voltage	✓
Current consumption from rated load voltage	-
Voltage output short-circuit protection	-
Voltage outputs	-
Min. load resistance (voltage range)	-
Max. capacitive load (current range)	-
Max. inductive load (current range)	-
Output voltage ranges	-
Operational limit of voltage ranges	-
Basic error limit voltage ranges	-
Destruction limit against external applied voltage	-
Current outputs	✓
Max. in load resistance (current range)	350 Ω
Max. inductive load (current range)	10 mH
Typ. open circuit voltage current output	12 V
Output current ranges	0 mA ... +20 mA +4 mA ... +20 mA
Operational limit of current ranges	+/-0.2%
Basic error limit current ranges	+/-0.1%
Destruction limit against external applied voltage	max. 12V (30V for 1s)
Settling time for ohmic load	0.25 ms
Settling time for capacitive load	-
Settling time for inductive load	1.5 ms
Resolution in bit	16
Conversion time	400 μs all channels

032-1CD40 - AO 4x16Bit 0(4)...20mA > Technical data

Order no.	032-1CD40
Substitute value can be applied	no
Output data size	8 Byte
Status information, alarms, diagnostics	
Status display	yes
Interrupts	no
Process alarm	no
Diagnostic interrupt	no
Diagnostic functions	yes
Diagnostics information read-out	possible
Supply voltage display	green LED
Group error display	red LED
Channel error display	red LED per channel
Isolation	
Between channels	-
Between channels of groups to	-
Between channels and backplane bus	✓
Between channels and power supply	✓
Max. potential difference between circuits	-
Max. potential difference between inputs (U _{cm})	-
Max. potential difference between Mana and Mintern (U _{iso})	DC 75 V/ AC 50 V
Max. potential difference between inputs and Mana (U _{cm})	-
Max. potential difference between inputs and Mintern (U _{iso})	-
Max. potential difference between Mintern and outputs	-
Insulation tested with	DC 500 V
Datasizes	
Input bytes	0
Output bytes	8
Parameter bytes	10
Diagnostic bytes	20
Housing	
Material	PPE / PPE GF10
Mounting	Profile rail 35 mm
Mechanical data	
Dimensions (WxHxD)	12.9 mm x 109 mm x 76.5 mm
Net weight	61 g

Order no.	032-1CD40
Weight including accessories	61 g
Gross weight	75 g
Environmental conditions	
Operating temperature	0 °C to 60 °C
Storage temperature	-25 °C to 70 °C
Certifications	
UL certification	yes
KC certification	yes

4.14.2 Parameter data

DS - Record set for access via CPU, PROFIBUS and PROFINET

IX - Index for access via CANopen

SX - Subindex for access via EtherCAT with Index 3100h + EtherCAT-Slot

More can be found in the according manual of your bus coupler.

Name	Bytes	Function	Default	DS	IX	SX
RES0	1	reserved	00h	00h	3100h	01h
WIBRK_EN	1	Wire-break recognition	00h	00h	3101h	02h
CH0FN	1	Function number channel 0	31h	80h	3102h	03h
CH1FN	1	Function number channel 1	31h	81h	3103h	04h
CH2FN	1	Function number channel 2	31h	82h	3104h	05h
CH3FN	1	Function number channel 3	31h	83h	3105h	06h

WIBRK_EN Wire-break recognition

Byte	Bit 7 ... 0
0	<ul style="list-style-type: none"> ■ Bit 0: Wire-break recognition channel 0 (1: on) ■ Bit 1: Wire-break recognition channel 1 (1: on) ■ Bit 2: Wire-break recognition channel 2 (1: on) ■ Bit 3: Wire-break recognition channel 3 (1: on) ■ Bit 7 ... 4: reserved



Please consider with enabled wire break recognition with the output range 0 ... 20mA, when the current goes below of 40µA (100 Digits), this can may lead to sporadic wire break messages!

CHxFN Function number channel x

In the following there are the measuring ranges with corresponding function number listed, which were supported by the analog module. With FFh the corresponding channel is deactivated. The formulas listed here allow you to transform an evaluated measuring value (digital value) to a value assigned to the measuring range (analog value) and vice versa.

0 ... 20mA

Output range (funct. no.)	Current (I)	Decimal (D)	Hex	Range	Formulas
0 ... 20mA Siemens S7 format (31h)	23.52mA	32511	7EFFh	overrange	$I = D \times \frac{20}{27648}$ $D = 27648 \times \frac{I}{20}$
	20mA	27648	6C00h	nominal range	
	10mA	13824	3600h		
	0mA	0	0000h		
	Not possible, is limited to 0mA.			underrange	
0 ... 20mA Siemens S5 format (41h)	25.00mA	20480	5000h	overrange	$I = D \times \frac{20}{16384}$ $D = 16384 \times \frac{I}{20}$
	20mA	16384	4000h	nominal range	
	10mA	8192	2000h		
	0mA	0	0000h		
	Not possible, is limited to 0mA.			underrange	

4 ... 20mA

Output range (funct. no.)	Current (I)	Decimal (D)	Hex	Range	Formulas
4 ... 20mA Siemens S7 format (30h)	22.81mA	32511	7EFFh	overrange	$I = D \times \frac{16}{27648} + 4$ $D = 27648 \times \frac{I-4}{16}$
	20mA	27648	6C00h	nominal range	
	12mA	13824	3600h		
	4mA	0	0000h		
	0mA	-6912	E500h	underrange	
4 ... 20mA Siemens S5 format (40h)	24.00mA	20480	5000h	overrange	$I = D \times \frac{16}{16384} + 4$ $D = 16384 \times \frac{I-4}{16}$
	20mA	16384	4000h	nominal range	
	12mA	8192	2000h		
	4mA	0	0000h		
	0mA	-4096	F000h	underrange	

4.14.3 Diagnostic data

So this module does not support interrupt functions, the diagnostics data serve for information about this module. On error the corresponding channel LED of the module is activated and the error is registered in the diagnostics data.

The following errors are listed in the diagnostics data:

- Error in project engineering / parameterization
- Wire-break (if parameterized)

DS - Record set for access via CPU, PROFIBUS and PROFINET. The access happens by DS 01h. Additionally the first 4 bytes may be accessed by DS 00h.

IX - Index for access via CANopen. The access happens by IX 2F01h. Additionally the first 4 bytes may be accessed by IX 2F00h.

SX - Subindex for access via EtherCAT with Index 5005h.

More can be found in the according manual of your bus coupler.

Name	Bytes	Function	Default	DS	IX	SX
ERR_A	1	Diagnostic	00h	01h	2F01h	02h
MODTYP	1	Module information	15h			03h
ERR_C	1	reserved	00h			04h
ERR_D	1	Diagnostic	00h			05h
CHTYP	1	Channel type	73h			06h
NUMBIT	1	Number diagnostic bits per channel	08h			07h
NUMCH	1	Number of channels of a module	04h			08h
CHERR	1	Channel error	00h			09h
CH0ERR	1	Channel-specific error channel 0	00h			0Ah
CH1ERR	1	Channel-specific error channel 1	00h			0Bh
CH2ERR	1	Channel-specific error channel 2	00h			0Ch
CH3ERR	1	Channel-specific error channel 3	00h			0Dh
CH4ERR... CH7ERR	4	reserved	00h			0Eh ... 11h
DIAG_US	4	µs ticker	00h			13h

ERR_A Diagnostic

Byte	Bit 7 ... 0
0	<ul style="list-style-type: none"> ■ Bit 0: set at module failure ■ Bit 1: set at internal error ■ Bit 2: set at external error ■ Bit 3: set at channel error ■ Bit 4: set at external auxiliary supply missing ■ Bit 6 ... 5: reserved ■ Bit 7: set at error in parameterization

032-1CD40 - AO 4x16Bit 0(4)...20mA > Diagnostic data

MODTYP Module information

Byte	Bit 7 ... 0
0	<ul style="list-style-type: none"> ■ Bit 3 ... 0: module class <ul style="list-style-type: none"> – 0101b analog module ■ Bit 4: set at channel information present ■ Bit 7 ... 5: reserved

ERR_D Diagnostic

Byte	Bit 7 ... 0
0	<ul style="list-style-type: none"> ■ Bit 2 ... 0: reserved ■ Bit 3: set at internal diagnostics buffer overflow ■ Bit 4: set at internal communication error ■ Bit 7 ... 5: reserved

CHTYP Channel type

Byte	Bit 7 ... 0
0	<ul style="list-style-type: none"> ■ Bit 6 ... 0: Channel type <ul style="list-style-type: none"> – 70h: Digital input – 71h: Analog input – 72h: Digital output – 73h: Analog output – 74h: Analog input/output – 76h: Counter ■ Bit 7: reserved

NUMBIT Diagnostic bits

Byte	Bit 7 ... 0
0	Number of diagnostic bits per channel (here 08h)

NUMCH Channels

Byte	Bit 7 ... 0
0	Number of channels of a module (here 04h)

CHERR Channel error

Byte	Bit 7 ... 0
0	<ul style="list-style-type: none"> ■ Bit 0: set at error in channel group 0 ■ Bit 1: set at error in channel group 1 ■ Bit 2: set at error in channel group 2 ■ Bit 3: set at error in channel group 3 ■ Bit 7 ... 4: reserved

CH0ERR ... CH3ERR Channel-specific

Byte	Bit 7 ... 0
0	Channel-specific error channel x: <ul style="list-style-type: none"> ■ Bit 0: set at configuring/parameter assignment error ■ Bit 3 ... 1: reserved ■ Bit 4: set at wire-break ■ Bit 7 ... 5: reserved

DIAG_US μ s ticker

Byte	Bit 7 ... 0
0...3	Value of the μ s ticker at the moment of the diagnostic

 μ s ticker

In the System SLIO module there is a timer (μ s ticker). With PowerON the timer starts counting with 0. After $2^{32}-1\mu$ s the timer starts with 0 again.

4.15 032-1CD70 - AO 4x16Bit ±10V

Properties

The electronic module has 4 outputs with parameterizable functions. The channels of the module are electrically isolated from the backplane bus. In addition, the channels are isolated to the DC 24V power supply by means of DC/DC converter.

- 4 analog outputs
- Suited for sensors with ±10V, 0 ... 10V
- Diagnostics function
- 16bit resolution

Structure

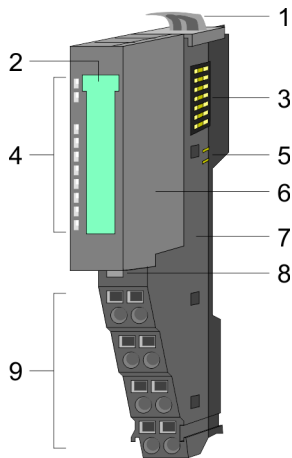

- 1 Locking lever terminal module
- 2 Labeling strip
- 3 Backplane bus
- 4 LED status indication
- 5 DC 24V power section supply
- 6 Electronic module
- 7 Terminal module
- 8 Locking lever electronic module
- 9 Terminal

Status indication

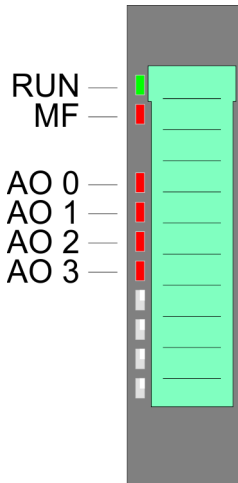

RUN	MF	AO x	Description
<input checked="" type="checkbox"/> green	<input checked="" type="checkbox"/> red	<input checked="" type="checkbox"/> red	
<input checked="" type="checkbox"/>	<input type="checkbox"/>	X	Bus communication is OK Module status is OK
<input checked="" type="checkbox"/>	<input checked="" type="checkbox"/>	X	Bus communication is OK Module status reports an error
<input type="checkbox"/>	<input checked="" type="checkbox"/>	X	Bus communication is not possible Module status reports an error
<input type="checkbox"/>	<input type="checkbox"/>	X	Error at bus power supply
X	<input checked="" type="checkbox"/> 2Hz	X	Error in configuration ↗ <i>Chap. 2.8 'Trouble shooting - LEDs' page 30</i>
<input checked="" type="checkbox"/>	<input type="checkbox"/>	<input checked="" type="checkbox"/>	Error channel x <ul style="list-style-type: none"> ■ Overload, short-circuit ■ Error in parameterization
not relevant: X			

Pin assignment

For wires with a cross section of 0.08mm² up to 1.5mm².

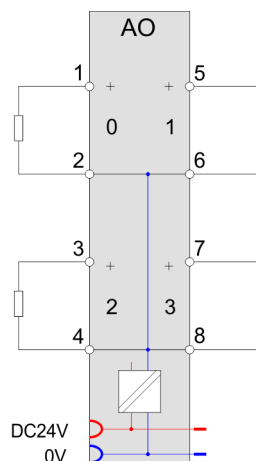
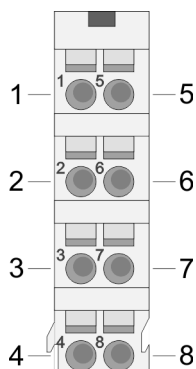

Pos.	Function	Type	Description
1	AO 0	O	Channel 0
2	AGND	O	Ground channels
3	AO 2	O	Channel 2
4	AGND	O	Ground channels
5	AO 1	O	Channel 1
6	AGND	O	Ground channels
7	AO 3	O	Channel 3
8	AGND	O	Ground channels

O: Output

Input area

No byte of the input area is used by the module.

Output area

At CPU, PROFIBUS and PROFINET the output area is embedded to the corresponding address area.

IX - Index for access via CANopen with s = Subindex, depends on number and type of analog modules

SX - Subindex for access via EtherCAT with Index 7000h + EtherCAT-Slot

More can be found in the according manual of your bus coupler.

Addr.	Name	Bytes	Function	IX	SX
+0	AO 0	2	Analog value channel 0	6411h/s	01h
+2	AO 1	2	Analog value channel 1	6411h/s+1	02h
+4	AO 2	2	Analog value channel 2	6411h/s+2	03h
+6	AO 3	2	Analog value channel 3	6411h/s+3	04h

4.15.1 Technical data

Order no.	032-1CD70
Type	SM 032
Module ID	050A 2560
Current consumption/power loss	
Current consumption from backplane bus	65 mA
Current consumption from load voltage L+ (without load)	20 mA
Power loss	0.8 W
Technical data analog outputs	
Number of outputs	4
Cable length, shielded	200 m
Rated load voltage	DC 24 V
Reverse polarity protection of rated load voltage	✓
Current consumption from rated load voltage	-
Voltage output short-circuit protection	✓
Voltage outputs	✓
Min. load resistance (voltage range)	5 k Ω
Max. capacitive load (current range)	1 μ F
Max. inductive load (current range)	10 mA
Output voltage ranges	-10 V ... +10 V 0 V ... +10 V
Operational limit of voltage ranges	+/-0.2%
Basic error limit voltage ranges	+/-0.1%
Destruction limit against external applied voltage	max. 24V
Current outputs	-
Max. in load resistance (current range)	-
Max. inductive load (current range)	-
Typ. open circuit voltage current output	-
Output current ranges	-
Operational limit of current ranges	-
Basic error limit current ranges	-
Destruction limit against external applied voltage	-
Settling time for ohmic load	300 μ s
Settling time for capacitive load	3 ms
Settling time for inductive load	-
Resolution in bit	16
Conversion time	200 μ s all channels

Order no.	032-1CD70
Substitute value can be applied	no
Output data size	8 Byte
Status information, alarms, diagnostics	
Status display	yes
Interrupts	no
Process alarm	no
Diagnostic interrupt	no
Diagnostic functions	yes
Diagnostics information read-out	possible
Supply voltage display	green LED
Group error display	red LED
Channel error display	red LED per channel
Isolation	
Between channels	-
Between channels of groups to	-
Between channels and backplane bus	✓
Between channels and power supply	✓
Max. potential difference between circuits	-
Max. potential difference between inputs (U _{cm})	-
Max. potential difference between Mana and Mintern (U _{iso})	DC 75 V/ AC 50 V
Max. potential difference between inputs and Mana (U _{cm})	-
Max. potential difference between inputs and Mintern (U _{iso})	-
Max. potential difference between Mintern and outputs	-
Insulation tested with	DC 500 V
Datasizes	
Input bytes	0
Output bytes	8
Parameter bytes	10
Diagnostic bytes	20
Housing	
Material	PPE / PPE GF10
Mounting	Profile rail 35 mm
Mechanical data	
Dimensions (WxHxD)	12.9 mm x 109 mm x 76.5 mm
Net weight	61 g

032-1CD70 - AO 4x16Bit ±10V > Parameter data

Order no.	032-1CD70
Weight including accessories	61 g
Gross weight	75 g
Environmental conditions	
Operating temperature	0 °C to 60 °C
Storage temperature	-25 °C to 70 °C
Certifications	
UL certification	yes
KC certification	yes

4.15.2 Parameter data

DS - Record set for access via CPU, PROFIBUS and PROFINET

IX - Index for access via CANopen

SX - Subindex for access via EtherCAT with Index 3100h + EtherCAT-Slot

More can be found in the according manual of your bus coupler.

Name	Bytes	Function	Default	DS	IX	SX
RES0	1	reserved	00h	00h	3100h	01h
SHORT_EN	1	Short-circuit recognition	00h	00h	3101h	02h
CH0FN	1	Function number channel 0	12h	80h	3102h	03h
CH1FN	1	Function number channel 1	12h	81h	3103h	04h
CH2FN	1	Function number channel 2	12h	82h	3104h	05h
CH3FN	1	Function number channel 3	12h	83h	3105h	06h

SHORT_EN Short-circuit recognition

Byte	Bit 7 ... 0
0	<ul style="list-style-type: none"> ■ Bit 0: Short-circuit recognition channel 0 (1:on) ■ Bit 1: Short-circuit recognition channel 1 (1:on) ■ Bit 2: Short-circuit recognition channel 2 (1:on) ■ Bit 3: Short-circuit recognition channel 3 (1:on) ■ Bit 7 ... 4: reserved

CHxFN Function number channel x

In the following there are the measuring ranges with corresponding function number listed, which were supported by the analog module. With FFh the corresponding channel is deactivated. The formulas listed here allow you to transform an evaluated measuring value (digital value) to a value assigned to the measuring range (analog value) and vice versa.

±10V

Output range (funct. no.)	Voltage (U)	Decimal (D)	Hex	Range	Formulas
±10V Siemens S format (12h)	11.76V	32511	7EFFh	overrange	$U = D \times \frac{10}{27648}$ $D = 27648 \times \frac{U}{10}$
	10V	27648	6C00h	nominal range	
	5V	13824	3600h		
	0V	0	0000h		
	-5V	-13824	CA00h		
	-10V	-27648	9400h	underrange	
	-11.76V	-32512	8100h		
±10V Siemens S5 format (22h)	12.5V	20480	5000h	overrange	$U = D \times \frac{10}{16384}$ $D = 16384 \times \frac{U}{10}$
	10V	16384	4000h	nominal range	
	5V	8192	2000h		
	0V	0	0000h		
	-5V	-8192	E000h		
	-10V	-16384	C000h		
	-12.5V	-20480	B000h		

0 ... 10V

Output range (funct. no.)	Voltage (U)	Decimal (D)	Hex	Range	Formulas
0 ... 10V Siemens S7 format (10h)	11.76V	32511	7EFFh	overrange	$U = D \times \frac{10}{27648}$ $D = 27648 \times \frac{U}{10}$
	10V	27648	6C00h	nominal range	
	5V	13824	3600h		
	0V	0	0000h		
	Not possible, is limited to 0V.				
0 ... 10V Siemens S5 format (20h)	12.5V	20480	5000h	overrange	$U = D \times \frac{10}{16384}$ $D = 16384 \times \frac{U}{10}$
	10V	16384	4000h	nominal range	
	5V	8192	2000h		
	0V	0	0000h		
	Not possible, is limited to 0V.				

4.15.3 Diagnostic data

So this module does not support diagnostic interrupt functions, the diagnostics data serve for information about this module. On error the corresponding channel LED of the module is activated and the error is registered in the diagnostics data.

The following errors are listed in the diagnostics data:

- Error in project engineering / parameterization
- Short-circuit/overload (if parameterized)

DS - Record set for access via CPU, PROFIBUS and PROFINET. The access happens by DS 01h. Additionally the first 4 bytes may be accessed by DS 00h.

IX - Index for access via CANopen. The access happens by IX 2F01h. Additionally the first 4 bytes may be accessed by IX 2F00h.

SX - Subindex for access via EtherCAT with Index 5005h.

More can be found in the according manual of your bus coupler.

Name	Bytes	Function	Default	DS	IX	SX
ERR_A	1	Diagnostic	00h	01h	2F01h	02h
MODTYP	1	Module information	15h			03h
ERR_C	1	reserved	00h			04h
ERR_D	1	Diagnostic	00h			05h
CHTYP	1	Channel type	73h			06h
NUMBIT	1	Number diagnostic bits per channel	08h			07h
NUMCH	1	Number of channels of a module	04h			08h
CHERR	1	Channel error	00h			09h
CH0ERR	1	Channel-specific error channel 0	00h			0Ah
CH1ERR	1	Channel-specific error channel 1	00h			0Bh
CH2ERR	1	Channel-specific error channel 2	00h			0Ch
CH3ERR	1	Channel-specific error channel 3	00h			0Dh
CH4ERR... CH7ERR	4	reserved	00h			0Eh ... 11h
DIAG_US	4	µs ticker	00h			13h

ERR_A Diagnostic

Byte	Bit 7 ... 0
0	<ul style="list-style-type: none"> ■ Bit 0: set at module failure ■ Bit 1: set at internal error ■ Bit 2: set at external error ■ Bit 3: set at channel error ■ Bit 4: set at external auxiliary supply missing ■ Bit 6 ... 5: reserved ■ Bit 7: set at error in parameterization

MODTYP Module information

Byte	Bit 7 ... 0
0	<ul style="list-style-type: none"> ■ Bit 3 ... 0: module class <ul style="list-style-type: none"> – 0101b analog module ■ Bit 4: set at channel information present ■ Bit 7 ... 5: reserved

ERR_D Diagnostic

Byte	Bit 7 ... 0
0	<ul style="list-style-type: none"> ■ Bit 2 ... 0: reserved ■ Bit 3: set at internal diagnostics buffer overflow ■ Bit 4: set at internal communication error ■ Bit 7 ... 5: reserved

CHTYP Channel type

Byte	Bit 7 ... 0
0	<ul style="list-style-type: none"> ■ Bit 6 ... 0: Channel type <ul style="list-style-type: none"> – 70h: Digital input – 71h: Analog input – 72h: Digital output – 73h: Analog output – 74h: Analog input/output – 76h: Counter ■ Bit 7: reserved

NUMBIT Diagnostic bits

Byte	Bit 7 ... 0
0	Number of diagnostic bits per channel (here 08h)

NUMCH Channels

Byte	Bit 7 ... 0
0	Number of channels of a module (here 04h)

CHERR Channel error

Byte	Bit 7 ... 0
0	<ul style="list-style-type: none"> ■ Bit 0: set at error in channel group 0 ■ Bit 1: set at error in channel group 1 ■ Bit 2: set at error in channel group 2 ■ Bit 3: set at error in channel group 3 ■ Bit 7 ... 4: reserved

CH0ERR ... CH3ERR Channel-specific

Byte	Bit 7 ... 0
0	Channel-specific error channel x: <ul style="list-style-type: none"> ■ Bit 0: set at configuring/parameter assignment error ■ Bit 2 ... 1: reserved ■ Bit 3: set at short-circuit to ground ■ Bit 7 ... 4: reserved

032-1CD70 - AO 4x16Bit $\pm 10V$ > Diagnostic data

CH4ERR ... CH7ERR
reserved

Byte	Bit 7 ... 0
0	reserved

DIAG_US μs ticker

Byte	Bit 7 ... 0
0...3	Value of the μs ticker at the moment of the diagnostic

μs ticker

In the System SLIO module there is a timer (μs ticker). With PowerON the timer starts counting with 0. After $2^{32}-1\mu s$ the timer starts with 0 again.