

Flexy 205

INSTALLATION GUIDE

IG-0028-00 1.3 en-US ENGLISH



Important User Information

Disclaimer

The information in this document is for informational purposes only. Please inform HMS Industrial Networks of any inaccuracies or omissions found in this document. HMS Industrial Networks disclaims any responsibility or liability for any errors that may appear in this document.

HMS Industrial Networks reserves the right to modify its products in line with its policy of continuous product development. The information in this document shall therefore not be construed as a commitment on the part of HMS Industrial Networks and is subject to change without notice. HMS Industrial Networks makes no commitment to update or keep current the information in this document.

The data, examples and illustrations found in this document are included for illustrative purposes and are only intended to help improve understanding of the functionality and handling of the product. In view of the wide range of possible applications of the product, and because of the many variables and requirements associated with any particular implementation, HMS Industrial Networks cannot assume responsibility or liability for actual use based on the data, examples or illustrations included in this document nor for any damages incurred during installation of the product. Those responsible for the use of the product must acquire sufficient knowledge in order to ensure that the product is used correctly in their specific application and that the application meets all performance and safety requirements including any applicable laws, regulations, codes and standards. Further, HMS Industrial Networks will under no circumstances assume liability or responsibility for any problems that may arise as a result from the use of undocumented features or functional side effects found outside the documented scope of the product. The effects caused by any direct or indirect use of such aspects of the product are undefined and may include e.g. compatibility issues and stability issues.

Table of Contents

Page

1	Preface	3
1.1	About This Document	3
1.2	Document history	3
1.3	Related Documents	3
1.4	Trademark Information	3
2	Product Summary.....	4
2.1	Introduction	4
2.2	Modular Concept of the Flexy 205	4
2.3	Features of the Flexy 205	5
2.4	General Specification of the Hardware Platform	5
2.5	Typical applications	6
2.6	Part Numbers	6
3	Safety, Environmental and Regulatory Information.....	7
3.1	Scope.....	7
3.2	Power Supply	7
3.3	ESD Damage Prevention	7
3.4	Applicable Directives, Standards and Compliance	7
3.5	Reference Standards for Type Tests.....	8
3.6	Internal Battery	9
3.7	Field Implementation & Environmental Conditions	9
4	Hardware Description	13
4.1	Label.....	13
4.2	Mechanical Dimensions.....	14
4.3	Physical Interface	14
5	Extension Cards	18
5.1	Slot Compatibility.....	18
5.2	Extension Card Insertion.....	18
5.3	Powering On the Flexy 205 with its Extension Cards	19
5.4	Multiple Extension Cards	19
5.5	Ethernet Extension Card - FLX 3101	20
6	IP Address & Access to the Web Configuration.....	21
6.1	Factory Default IP Settings	21
6.2	Powering On	21
6.3	Connecting to the LAN IP Address	21
6.4	Web Interface	21

7	Resetting the Flexy 205	23
7.1	Normal Boot Sequence	23
7.2	First Level Reset (User Reset)	23
7.3	Second Level Reset (Factory Reset)	23
7.4	Reset Impact Matrix	24
A	Connector Pinout & Related Specifications	25
A.1	Main Connector	25
A.2	Specification of the External Power Supply	25
A.3	Digital Output & Digital Inputs	26
B	Flexy 205 Products Overview	28
B.1	Extension Cards	28
C	Flexy 205 Isolation Scheme	30
C.1	Base Unit	30
C.2	Extension Cards	30

1 Preface

1.1 About This Document

This document describes the hardware of the Ewon Flexy 205 and explains how to get started with the embedded web site. It also describes the basic software tools needed to install the equipment.

For additional related documentation and file downloads, please visit www.ewon.biz/support.

1.2 Document history

Version	Date	Description
1.0	2018-01-12	Official release
1.1	2018-11-06	Changed: Flexy 205 label
1.2	2019-01-29	Changed: general review
1.3	2019-08-20	Changed: Safety, Environmental and Regulatory Information, p. 7

1.3 Related Documents

Document	Author	Document ID
Easy Commissioning via SD Card & USB Drive	HMS	AUG-0062-00
eBuddy	HMS	AUG-0063-00
Reference Guide for Flexy 205	HMS	RG-0008-00

1.4 Trademark Information

Ewon® is a registered trademark of HMS Industrial Networks SA. All other trademarks mentioned in this document are the property of their respective holders.

2 Product Summary

2.1 Introduction

The Flexy 205 is a modular industrial M2M router.

It has been designed to fulfill the following key requirements:

- Flexible WAN, allowing within the same product to address different Internet connectivity technologies (Ethernet, Wi-Fi, 4G,...) and securing the investment in case of technology upgrade (eg. 3G > 4G).
- Flexible Field, providing easy connection to a wide range of external devices, including various field protocols.
- Flexible Apps, embedding alarms, data logging, remote access, routing and web HMI applications with mouse click based configuration but also customization offering openness and programming tools.

The Flexy 205 is fully compatible with the [Talk2M cloud connectivity services](#) and with the [eFive](#) (a VPN server appliance) for real-time control application.



Fig. 1 Housing of the Flexy 205

2.2 Modular Concept of the Flexy 205

As the name *Flexy 205* suggests, it has been designed to enable numerous different combinations by addition of extension cards (check [Extension Cards, p. 28](#)).



Fig. 2 Modular Concept of the Flexy 205

1	Main connector including power input terminals (1 DO and 2 DIs)
2	Communication interface
3	Placeholder for extension cards

2.2.1 Flexy 205

The Flexy 205 features:

- 2 DIs and 1 DO.
- 2 free slots allowing the insertion of extension cards

2.2.2 Extension Cards

The extension cards extend the communication features by adding either:

- a WAN communication interface (Ethernet WAN, wireless modem, ...)
- a field communication interface (serial, IO card, ...)

How the extension cards should be integrated in the Ewon Flexy 205 is explained in [Extension Cards, p. 18](#).

2.3 Features of the Flexy 205

The following section lists the different main features supported by the Flexy 205.

- Open VPN
- Talk2M connections
- Data acquisition protocols (IO Servers)
- Alarm management and notification
- Data logging
- BASIC scripting
- JAVA ETK
- Web server
- ViewON 4 Web HMI
- FTP client and server
- HTTP(S) client (Get & Post requests)
- Ethernet to Serial gateway
- Routing between Ethernet interfaces (WAN to LAN)
- Routing features: IP forwarding, NAT, Port forwarding

2.4 General Specification of the Hardware Platform

Characteristic	Value
Design	Industrial design (24 VDC power supply, DIN Rail mounting, extended temperature)
Processor	ARM9
Clock	Real Time Clock (RTC) with battery backup Expected lifetime: 10 years
Ethernet Interface	4 configurable LAN/WAN Ethernet ports 10/100 Mbps
Digital Input	2
Digital Output	1
Mounting	Latch for DIN rail EN50022 compliant

2.5 Typical applications

Some of the typical applications for the Flexy 205 are the following ones:

- Remote access of Ethernet, serial and MPI devices
- Industrial VPN router
- Remote monitoring

2.6 Part Numbers

Available Part Numbers

Part Number	Type	Description
FLEXY20500_00MA	Flexy 205	M2M Data Gateway – 4 Ethernet ports



*In the above table, the MA extension stands for “Multiple language A” (regrouping EN, FR, DE and IT).
The part number syntax is explained in the [Label](#), p. 13.*

3 Safety, Environmental and Regulatory Information

3.1 Scope

The present section addresses safety, environmental and regulatory information for the Ewon Flexy 205.

This safety, environmental and regulatory information generally has a similar compliance frame but some aspects differ. For example: in the case of telecommunication extension cards, additional directives, standards and instructions apply.

3.2 Power Supply

The external power supply is a third party device that is not part of this certification.

The device shall be powered by an LPS power supply certified according to IEC/UL60950-1 or Class2 per NEC or by a 12-24Vdc 100w max. certified for 60°C and for altitudes up to 2000m for conformity to the UL/IEC 62368-1 (for more information, refer to [Specification of the External Power Supply, p. 25](#)).

3.3 ESD Damage Prevention

To avoid possible damage to the base unit and / or extension card, please wait 30 seconds after switching off the equipment before inserting (or removing) an extension card.



Always use ESD precautions when handling extension cards and / or opened base unit as they contain parts and assemblies susceptible to be damaged by electrostatic discharge (ESD).

The printed circuit boards (PCBs) of the Ewon Flexy 205 described in the present document are partially exposed when slot fillers are removed to place extension cards. In order to avoid ESD damage, the product, when it is opened, must be handled with the necessary precaution including:

- Grounded ESD functional work surface
- Personal grounding
- Verification that the configuration is compatible with the firmware capabilities before being operated.

The extension cards described in this document are modules exposing both sides of an electronic printed circuit board. Therefore, they are packed in anti static ESD bags. In order to avoid ESD damage, the product must be handled with the necessary precaution as described above.

3.4 Applicable Directives, Standards and Compliance

The Ewon Flexy 205 belongs to class A Information Technology Equipment (ITE). In a domestic environment, this product may cause radio interference in which case the user might have to take appropriate measures.

3.4.1 Conformity to European Directives

The Ewon Flexy 205 and its extension cards are in conformity with the following EC directives:

- RoHS Directive 2011/65/EU
- EMC Directive 2014/30/EU

- RE Directive 2014/53/EU¹

3.4.2 Applicable Safety Standards

The Ewon Flexy 205 and its extension cards are in conformity with the following safety standards:

- IEC/EN 60950-1
- UL 60950-1
- CSA-C22.2 No 60950-1-07
- EN/IEC 62368-1
- UL 62368-1
- CAN 62368-1

3.4.3 FCC Compliance

The Ewon Flexy 205 and its extension cards comply with Part 15 of the FCC Rules.

Operating is subject to the following two conditions:

- This device may not cause harmful interference
- This device must accept any interference received, including interference that may cause undesired operation.

3.4.4 Certifications

The Ewon Flexy 205 and its extension cards have been duly certified by authorized bodies:

- UL Certificate of Compliance (COC) # 20190529_E350576
- CB certificate # DK-84039-UL

These certificates can be downloaded on www.ewon.biz/support

3.5 Reference Standards for Type Tests

The Ewon Flexy 205 and their extension cards have been fully validated on temperature, vibration and shock against the requirements of the following standards:

Operating & Storage Temperature	
Test nature	Reference Standard
Cold test	IEC 60068-2-1
Dry heat test	IEC 60068-2-2
Temperature change test	IEC 60068-2-14
Cyclic damp heat test	IEC 60068-2-30
Vibration & Shock Tests	
Test nature	Reference Standard
Vibration test (sinusoidal)	IEC 60068-2-6
Vibration test (broad-band random)	IEC 60068-2-64
Shock test	IEC60068-2-27

1. When applicable, the product conforms to the corresponding RE Directive articles: RF spectrum efficiency: Art 3(2); EMC: Art. 3 (1)(b); Safety: Art. (3)(1)(a)

3.6 Internal Battery

The Ewon Flexy 205 contains a CR2032 battery. This battery is used to maintain the real time clock up-to-date even when the unit is not powered.

Here is a list of risks and recommendations regarding the battery:

- Risk of explosion if the battery is replaced by an incorrect type. The battery is not intended to be replaced by the consumer: the product shall be returned to the manufacturer for replacement.
- Do not ingest battery, chemical burn hazard.
- Keep new and used batteries away from children.
- If the cell battery is swallowed, it can cause several internal burns in just 2 hours and can lead to death.
- If the equipment's enclosure do not close securely, stop using the product and keep it away from children.
- If you think batteries might have been swallowed or placed inside any part of the body, seek immediate medical attention.



Risk of explosion if the battery is replaced by an incorrect type. The battery is not intended to be replaced by the consumer: the product shall be returned to the manufacturer for replacement.

3.7 Field Implementation & Environmental Conditions

3.7.1 Ingress Protection

The Ewon Flexy 205 has an IP20 protection grade. Therefore, the Ewon Flexy 205 is NOT suited for outdoor mounting.

It has to be integrated in an electrical cabinet, protected from excessive heat, humidity and dust. Do not push any sharp object into the air vents or openings of the equipment.

3.7.2 Mounting Recommendations

The product is intended to be mounted vertically, label on the right side.

The normal mounting position of the Ewon Flexy 205 is wall mounted on a horizontal [Omega type DIN-rail \(EN 50022\)](#).

- **Mounting the unit on DIN-rail**

Pull the slide lock (located at the bottom of the back-side of the unit) downwards and present the unit in front of the DIN rail. Tilt the Ewon upwards in order to hang it on the upper edge of the DIN rail by its hook. Gently tilt the unit downwards until it finds its original position. Pull the slide lock upwards to fix and lock the unit on the DIN rail.

- **Removing the unit from DIN-rail**

Release the unit by pulling the slide lock downwards while gently tilting the unit upwards. Free the unit by unhooking it from the upper rail edge.

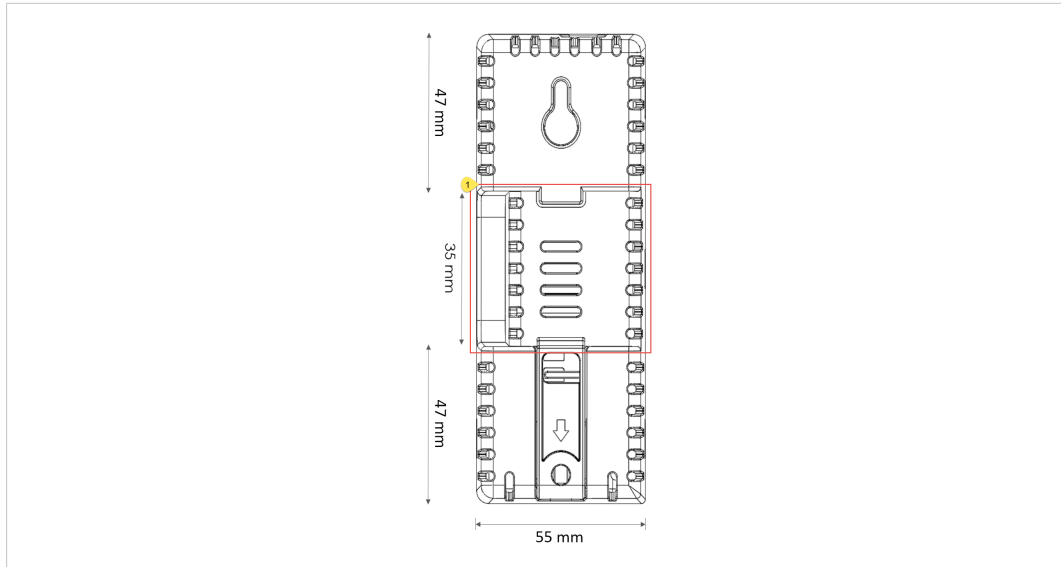

Fig. 3 DIN rail mounting position

#	Description
1	DIN rail mounting bracket

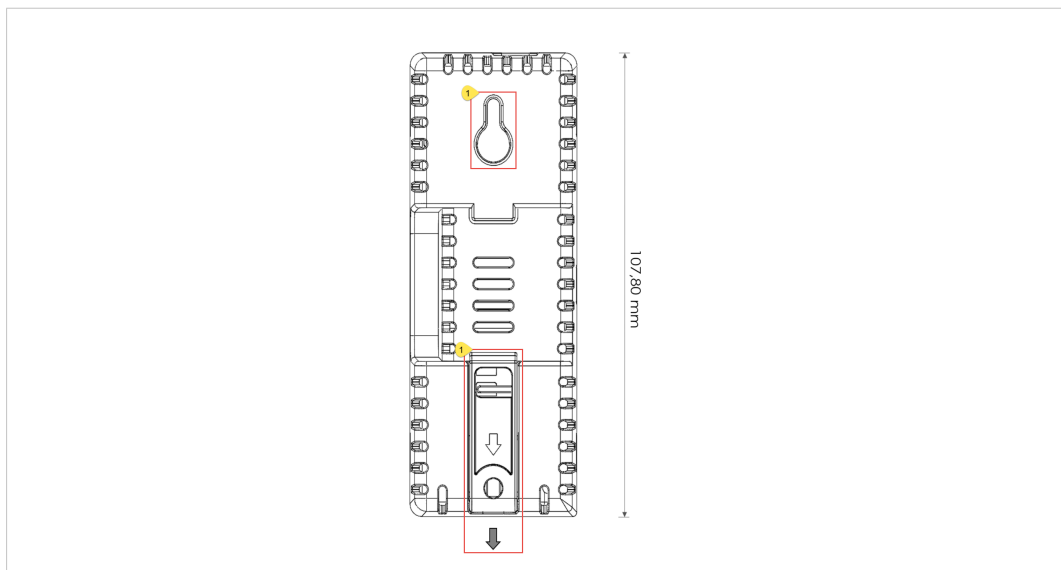

Fig. 4 Wall mounting position

#	Description
1	Wall mounting bracket (suggested screw dimensions 4,2 x 32 mm)

To ensure a proper ventilation of the equipment, a free gap of at least 2 cm must be respected in front of all upper & lower ventilation openings of the unit.

A free gap of at least 1 cm must be respected on each side of the unit.

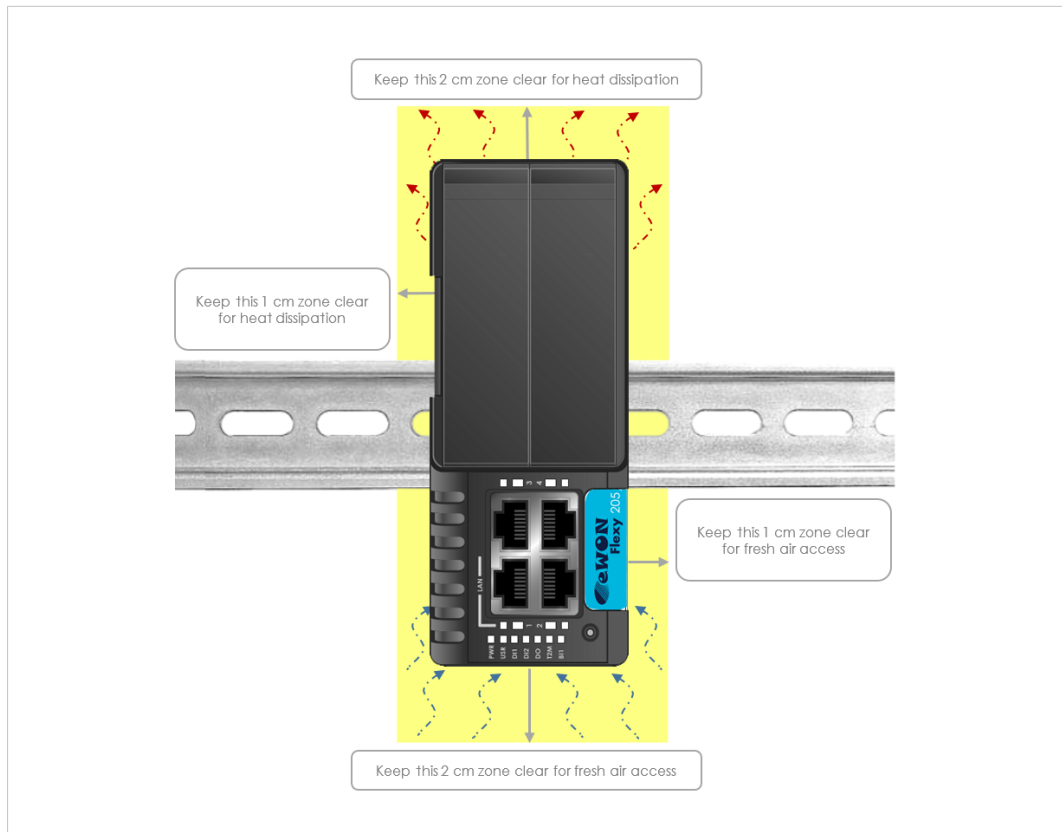

Fig. 5 Free gap surrounding the Ewon for heat dissipation.

3.7.3 Earthing

Earthing the Ewon is necessary to eliminate unwanted transients and to conform to the EMC requirements. Therefore, a functional earth (FE) terminal is available on the main connector as shown in [Specification of the External Power Supply, p. 25](#).

Connect this terminal directly to allow impedance ground. Shielded cables have to be used for Ethernet and USB to comply with the EMC requirements.

3.7.4 Environmental Limits

The equipment will operate properly within the following environmental limits provided it is mounted according to [Mounting Recommendations, p. 9](#).

Characteristic	Value
Operating temperature	-25° to +60°C
Storage temperature	-40° to +70°C
Relative humidity	10 to 95% non-condensing
Operating altitude	Up to maximum 2000m
Storage altitude	Up to maximum 3000m
Mounting	Latch for DIN rail EN50022-compliant

3.7.5 Labelling Information

The OEM User Manual (for integrators) must provide clear instructions, to the OEM, explaining the labelling requirements, options and OEM User Manual instructions that are required.

The host OEM User Manual (Ewon's manual) must contain clear instructions on how end users can find and/or access the module and the FCC ID

4 Hardware Description

4.1 Label

The identification label of the Ewon Flexy 205 is placed on the right hand side of the housing. The different parts of the label are described below:

Label	Definition
PN	Part Number (see syntax in <i>Syntax of the Part Number, p. 13</i>)
SN	Serial Number YYWW-SSSS-PP YY = 2 last digits of production year WW = production week number SSSS = Sequential production number PP = Product Code
MAC	MAC address of the Ethernet adapter
Rating	Power supply requirements
Marks	CE, UL,... logos if applicable





Fig. 6 Flexy 205 Label

Syntax of the Part Number

FLEXY12233_44AA/B			
Position(s)	Description	Acceptable values	
FLEXY	Name of the Ewon device model	Only Flexy (constant)	
1	Single figure Defines routing capabilities	2	M2M Router
22	Two figures Defines the type of the motherboard	05	4 configurable LAN/WAN Ethernet ports
33	Two figures Defines the primary software option	00	No primary software option
44	Two figures Defines the secondary software option	00	No secondary software option
AA	Two capital letters Defines the firmware language	MA	EN + FR + DE + IT
/B	Single capital letters Defines the model type	S	Compliance with UL / IEC / EN 60950 Standard

Marks

Marks	Description
	Conformité Européenne or European Conformity (EC)
	UL Recognized - Underwriters Laboratories

4.2 Mechanical Dimensions

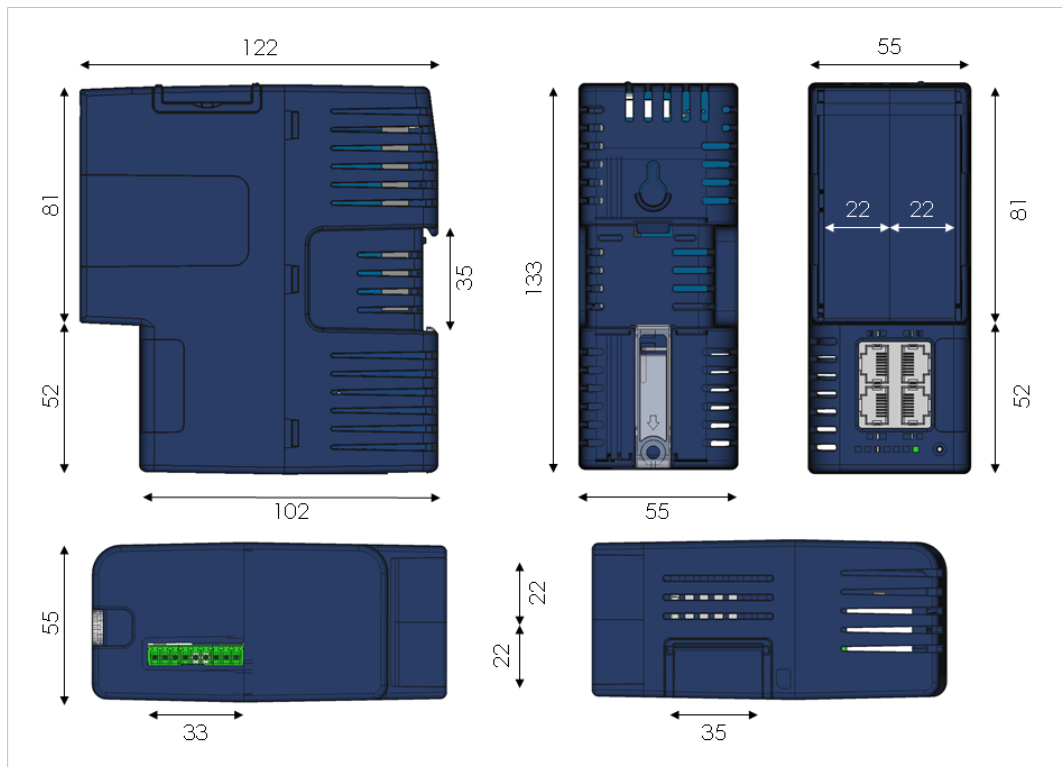

Fig. 7 Mechanical Dimensions

In the above picture:

- **Unit:** Dimensions are in millimeters (mm).
- **Accuracy:** Suited only for implementation drawings (rounded @ full mm).

Shaded areas show provisions of empty space that should be considered in the implementation arrangement.

The provision of empty space in front of the slot fillers is spared for the connectors of extension cards. Even if the application requires no extension card(s), it is good practice to plan the free space anyhow, in case an extension card is inserted later on.

4.3 Physical Interface

This section addresses the interface that represents the Ewon Flexy 205. The items numbered in the image below are explained subsequently in separate paragraphs.

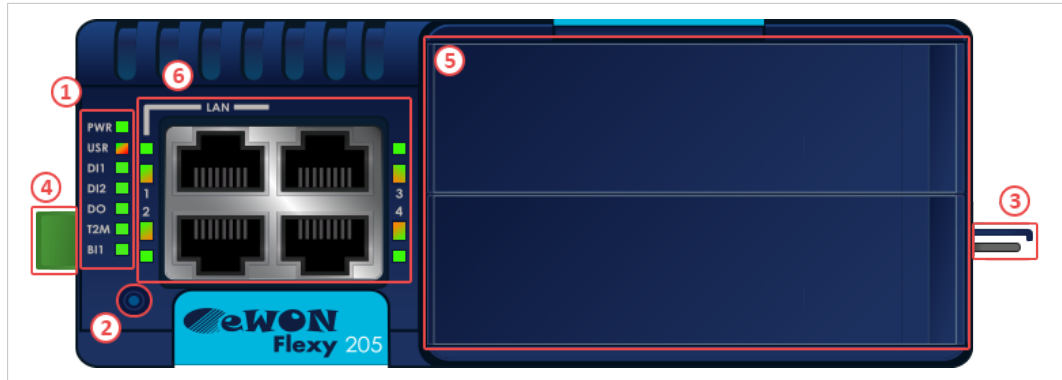

Fig. 8 Base Unit Interface

1	LED panel
2	RESET button - BI1
3	SD card slot
4	Main connector Used to connect the power supply and the digital I/O
5	2 slots fillers Can be removed and replaced by extension cards
6	Main board communication interfaces: 4 Ethernet Ports

4.3.1 LED Panel

The LED panel displays the system status and is located bottom to the 4 Ethernet ports. The following table explains the common LEDs of all base units.

Label	Definition
PWR	Power Steady green = unit is powered on
USR	User Blinking green slowly = Unit is ok Red pattern = special attention required
DI1	Digital IN 1 Green = ON : Signal on Input 1 detected
DI2	Digital IN 2 Green = ON : Signal on Input 2 detected
DO	Digital output Green = ON : Signal on Output detected
T2M	Talk2M Green = ON : Talk2M VPN connection established
BI1	Button BI1 input Steady green = reset button is being pressed

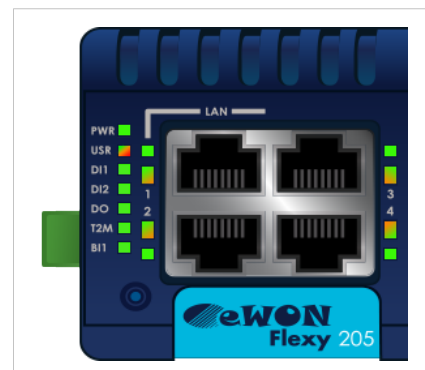

Fig. 9 LED Panel Example of a Flexy 205

4.3.2 Reset Button

The reset button allows the reset of the Flexy 205 partially (Reset Level 1) or completely (Reset Level 2). For the reset procedures check [Resetting the Flexy 205, p. 23](#).

4.3.3 SD Card Slot

The SD card can be used for two purposes:

- Easy Commissioning: Configure a Flexy 205 and perform actions such as a firmware upgrade / downgrade, recovery, restore a backup, Talk2M account integration, ...
- Extended User Memory: Named as the EUM card, it increases the user memory capacity of the Flexy 205.

The SD card slot is based on the Push-Push mechanism:

- Push the SD card down the slot until the mechanism clicks. As the click sound is heard, the SD card is now locked inside the card holder.
- Push on the SD card until it clicks again to retrieve it from the Flexy 205.

For more information on each of the possibilities offered with the SD card, easy commissioning or EUM, please refer to the [Related Documents, p. 3](#).

4.3.4 Main Connector

The Flexy 205 is powered via its main connector using a male connector (a mating female connector with screw terminals is delivered with the Ewon Flexy 205).

For details see [Main Connector, p. 25](#).

4.3.5 Two Slots for Extensions

The slot fillers can be removed to add extension cards. A general overview of the available extension cards is available in the [Extension Cards, p. 28](#).

It is recommended to never leave a slot empty. Either a slot filler or an extension card should always be inserted in the Flexy 205.

4.3.6 LAN / WAN Ethernet ports

The LAN / WAN interface consists of a 4 auto-sense Ethernet ports (10/100 Mbps). Auto-sense means that both UTP Class 5 direct and crossed cables with RJ45 terminations at both ends can be used. Default parameters see [Factory Default IP Settings, p. 21](#).



Fig. 10 Interface of the Flexy 205

However, the minimum required regarding the Ethernet cable type is Cat.5 with RJ45 connectors.

LED Interface

Label	Definition	
1	Big rectangle	Green = LAN port Orange = WAN port
	Small square	Ethernet activity on port 1 Green steady = Ethernet link OK Green flashing = Ethernet traffic (Rx and Tx)
2	Ethernet activity on port 2 (same as above)	
3	Ethernet activity on port 3 (same as above)	
4	Ethernet activity on port 4 (same as above)	

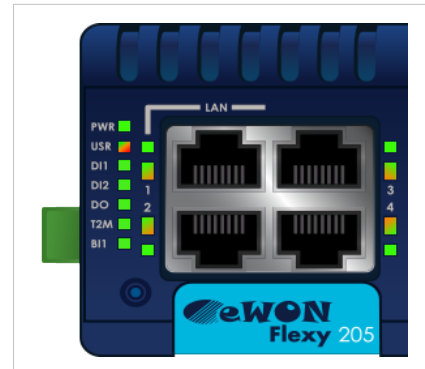

Fig. 11 LED Panel of the Flexy 205

5 Extension Cards

5.1 Slot Compatibility

The reference code of the extension cards includes a letter that defines their compatibility with a certain type of slots. In the case of the Flexy 205:

- FLA xxxx, FLB xxxx, FLX xxxx- designates cards that fit into either slots
- FLCxxxx - designates cards that fit into the Flexy 205 only (not compatibility with the Ewon Flexy 10x or 20x).

i The Type A, Type B or Type X slots are important for Flexy 10x and 20x. The Flexy 205 is compatible with all extension cards and doesn't rely on the reference code of the extension cards to position them.

In addition to the card reference, each type of extension card bears a visual compatibility symbol on its front panel.

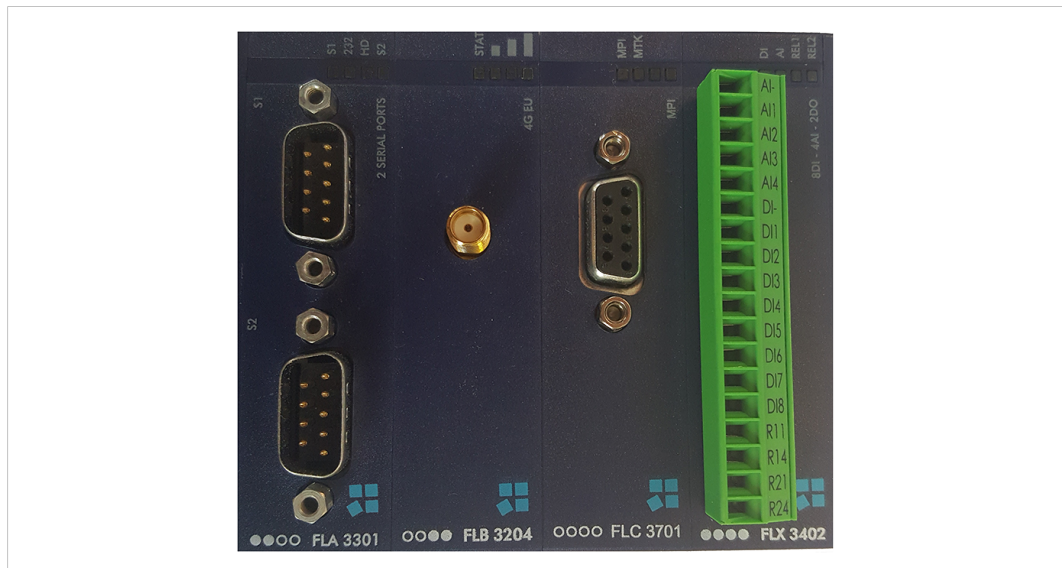

Fig. 12 Slot Compatibility Markings

Indication	Design	Location
1	●●●○	Any slot - Type A
2	●●●●	Any slot - Type X
3	○○●●	Any slot - Type B
4	○○○○	Any slot - Type C

5.2 Extension Card Insertion

! Wait 30 seconds after turning off the equipment before inserting (or removing) an extension card in order to avoid possible damage to the Ewon Flexy 205 and the extension cards.

Remove the slot filler of the location the new card will be inserted. To do this, press on both ends of the cover, note that the hooks are off-centered.

Insert the extension card carefully and slide it down until the hook clicks. Make sure the card is completely inserted. **DO NOT insist** if a resistance is felt when trying to insert the card.

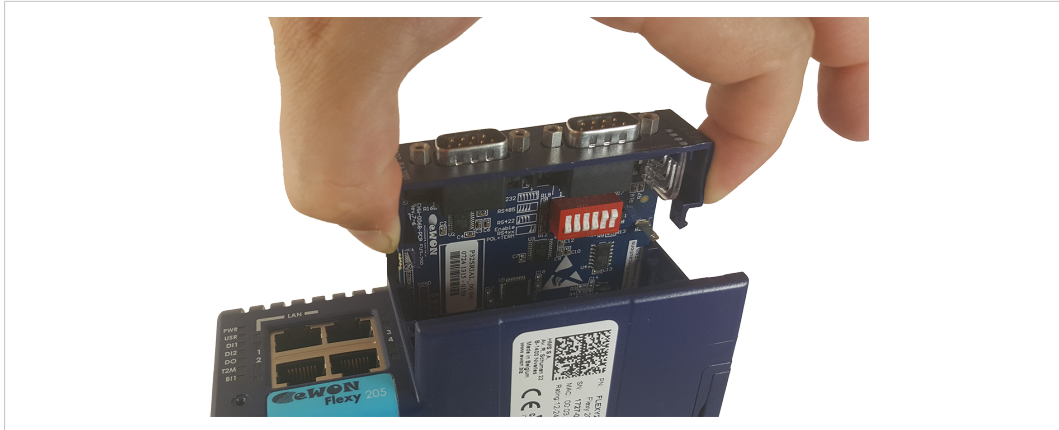

Fig. 13 Slot Removal



Hooks to be pressed are off-centered – press while pulling upwards

Boot the unit for the inserted extension cards to be detected. As explained in [Detected Cards Displayed in the System Page, p. 22](#), the web interface of the Flexy 205 has a diagnostic page showing the extension cards in their order of detection (from left to right).

5.3 Powering On the Flexy 205 with its Extension Cards

The normal boot sequence of the Flexy 205 takes approximately 25 seconds to complete. During this process, all LEDs go ON for a while except **BI1** as long as the RESET button is not pressed and the WAN / LAN Ethernet ports.

If the RESET button was pressed, the **USR** LED will be orange for a little time.

As soon as the boot process is finished and the unit is ready to be used, the **USR** LED blinks green slowly.

The extension card types are detected one slot after the other during the boot sequence and are automatically installed from a system standpoint.

5.4 Multiple Extension Cards

5.4.1 Detection Order

The boot sequence of the Flexy 205 includes an automated detection of the inserted extension cards. This detection is done sequentially, one slot after the other, starting from the left to the right (when holding the Flexy 205 with its logo on the right side).

5.4.2 Software Compatibility of Multiple Cards Combination

The Ewon Flexy 205 allows the insertion of multiple extension cards of the same type. Some configurations including multiple extension cards, even if mechanically acceptable, are not supported by the embedded software. Cards in excess are ignored during the automated detection process which means that the Flexy 205 and its running extension cards will operate normally.

The ignored card(s) will appear in the **Diagnostic > Status > System Info > System** but they will not be functional.

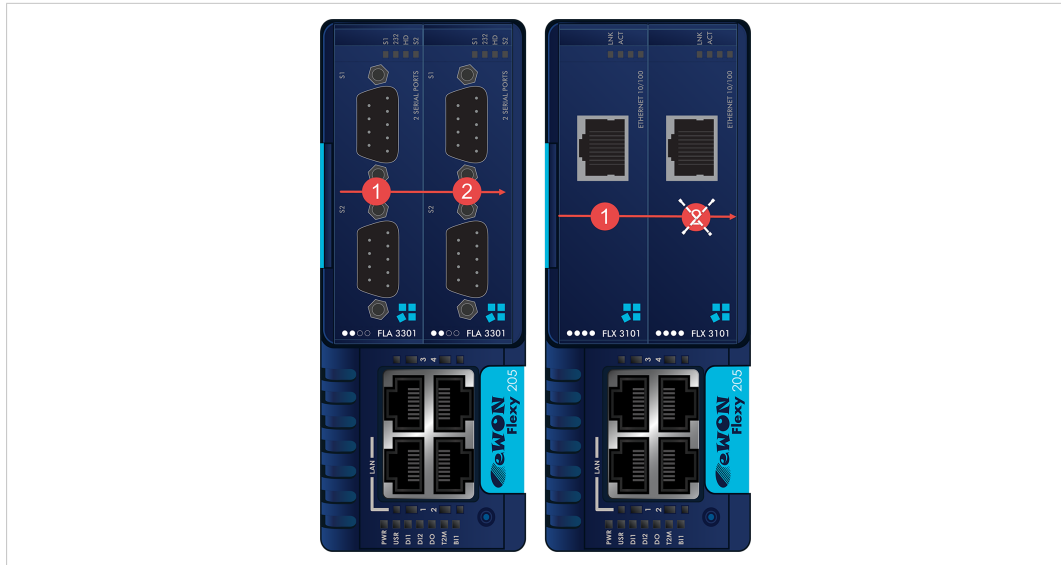

Fig. 14 Order of the Extension Cards

The picture above shows an example of a configuration that would be OK mechanically and power wise but would not be supported by the firmware.

During the boot process, the first 2 serial port extension cards are detected and both can be used. In case of 2 single Ethernet cards, these 2 cards are also detected but the second single Ethernet card is not supported by the firmware and so it cannot be used. The presence of this “ignored” card in the Flexy 205 does not alter the operation of the Flexy 205 itself nor does it alter its “accepted” extension cards.

5.5 Ethernet Extension Card - FLX 3101

By default and if there is no extension card available in the Flexy 205, the 4 Ethernet ports will be distributed as:

- Ports #1, #2 and #3 are set as LAN port.
- Port #4 is set as a WAN port.

If a FLX 3101 (single Ethernet port) extension card is inserted, the Flexy 205 will automatically switch all its ports to LAN leaving the Ethernet port of the extension card as the only WAN port able to connect to the Internet.



This switch to 4 LAN ports occurs only when an FLX 3101 is inserted. This doesn't happen if a Wi-Fi (FLB 3271) or a 3G / 4G (FLB 3202 / 3203 / 3204 / 3205) extension cards are plugged-in.

6 IP Address & Access to the Web Configuration

6.1 Factory Default IP Settings

Characteristics	Values
LAN IP address	10.0.0.53
LAN subnet mask	255.255.255.0
Gateway	0.0.0.0



The WAN IP address is set by default in DHCP mode.

6.2 Powering On

Power the unit on and wait approximately 25 seconds until the boot process is completed.

After a successful boot process the **USR** LED is blinking green slowly.

If the **USR** LED is blinking red according to a given pattern, it indicates an interruption of the boot process due to a problem. The most frequent issue is:

- a duplicate IP address was detected on the LAN network: **USR** LED blinking pattern is red 1x short, 1x long

For other LED patterns in case of error, please refer to General Reference Guide from the [Related Documents, p. 3](#).

6.3 Connecting to the LAN IP Address

Establish the first communication with the Flexy 205 by using Ewon companion tool **eBuddy** which can be downloaded from www.ewon.biz/support.

Connect the LAN port #1 of the Flexy 205 to the computer point-to-point or through a network provided the default IP address of the Flexy 205 will not conflict with another connected device.

Start the eBuddy application. The application scans through the Ethernet adapter network and retrieves the connected Ewon devices displaying the IP address, subnet mask and serial number.

The utility also allows the modification of the default IP address without being necessarily in the same network range. To do so, follow this process:

1. Start the eBuddy utility
2. *Optional: Highlight the row representing the device which IP address needs to be modified*
3. Click on the button "Set IP" from the top bar menu or hit F2 keyboard shortcut
4. If step 2 has been fulfilled, the serial number of the selected device appears in the new popup. If not, indicate the serial number of the device that needs to be modified. Click Next
5. Indicate the new IP address and its subnet mask. By clicking Next, eBuddy sends the command to the device to change its IP address and to reboot
6. Wait until the reboot has ended to reach the Flexy 205 on its new IP address

6.4 Web Interface

While the computer is connected to a LAN port of the Flexy 205, open an Internet browser and reach the Flexy 205 web server which URL is the LAN IP address of the Flexy 205 (default is 10.0.0.53).

Another way to access the web panel of the Flexy 205 is by using eBuddy with its EZ DHCP feature. For more info, refer to eBuddy from the [Related Documents, p. 3](#).

Before beginning the configuration of the Flexy 205, an authentication is required.



Default login & password are both *adm*. For security reasons, default password **must** be modified. To change it, go to **Setup > Users** and double click on the *adm* entry to edit its parameters. Enter the new password twice and click **Save**.

At the very first boot of the Flexy 205 or after a reset level 2 and after successfully logging in, an interface language selection will be proposed.

A configuration wizard will be proposed afterwards which sets the configuration of the Flexy 205 but also the connection to the Talk2M environment.

On Ewon website, a [Quick Start Guide](#) can be found which helps in the configuration of the Flexy 205.

6.4.1 Detected Cards Displayed in the System Page

The **System** page allows to check the status of the system including detected extension cards.

To access the system status summary, click on **Diagnostic > Status > System Info > System**.

7 Resetting the Flexy 205

The reset button **BI1** is located at the bottom right of the Ewon Flexy 205 (see [Reset Button, p. 15](#)). The reset function of this button is active only if pressed while powering on. The Flexy 205 features two type of reset levels. A table with the impacted configuration zones per reset level can be found in [Reset Impact Matrix, p. 24](#).

7.1 Normal Boot Sequence

The normal boot sequence of the Flexy 205 takes approximately 25 seconds to complete. During this process, all LEDs of the left row go ON for a while, except **BI1** as long as the RESET button is not pressed and the WAN / LAN Ethernet ports.

If the RESET button was pressed, the **USR** LED will be orange for a little time.

As soon as the boot process is finished and the unit is ready to be used, the **USR** LED blinks green slowly.

7.2 First Level Reset (User Reset)

The first level reset consists in formatting only the “*user files*” part of the non volatile memory. This type of reset does not modify the communication parameters of the Flexy 205.

How to generate a first level reset:

1. Power the unit OFF and ON again
2. **Immediately press and maintain** the reset button. The LED labeled **BI1** turns ON
3. Wait approximately 30 seconds until the **USR** LED blinks red 1x per second
4. Immediately release the button. The LED labeled **BI1** turns OFF. If the button keeps being pressed at this point, the second level reset will be engaged
5. Wait approximately 30 seconds until the reset procedure is completed.
6. The Flexy 205 restarts automatically and the unit is ready to be used, the **USR** LED blinks green slowly.

7.3 Second Level Reset (Factory Reset)

This second level reset formats all non volatile memories and erases the Flexy 205 back to its factory defaults. This operation consists in 3 steps:

- Erasure of all non volatile memories, including all COM parameters and IP addresses
- Full hardware auto test with result shown by the **USR** LED
- Return to factory configuration (default one)

How to generate a second level reset:

1. Power the unit OFF and ON again
2. **Immediately press and maintain** the reset button. The LED labeled **BI1** turns ON
3. Wait approximately 35 seconds until the **USR** LED remains red steady
4. When this state is reached, release the button. The LED labeled **BI1** turns OFF
5. It takes no longer than 5 seconds to complete.

6. Check if the auto test is successful, the **USR** LED blinks red following a pattern of 200ms ON and 1,5 sec OFF. The Flexy 205 does not restart in normal mode by itself and remains in this diagnose mode.
7. Power the Flexy 205 OFF and ON again to reboot the unit in normal mode. As described before, the Flexy 205 returns to its default COM parameters and factory IP addresses (default LAN IP: 10.0.0.53) after this second level reset is performed.

If a different pattern than the successful auto test one is displayed then this pattern reflects an issue.

The pattern starts with 200ms ON (beginning of the pattern) followed by OFF and a certain number of times 1 sec ON which allows to identify the nature of the detected problem. Please write down the observed pattern and contact the local distributor referring to the pattern error.

7.4 Reset Impact Matrix

	Erased or Reset	Preserved
Impact Reset Level 1 User Reset	User(s)	LAN IP address + mask
	<i>adm</i> password	Internet access
	Tags	Language settings
	IO Server config	COM settings (modem, etc)
	Gateway config	Talk2M config + key
	Ewon Identification	Proxy configuration
	User Web site	Memory configuration
	User Scripts	
Impact Reset Level 2 Factory Reset	LAN IP address + mask	Nothing
	Internet access	
	Language settings	
	COM settings (modem, etc)	
	Talk2M config + key	
	Proxy configuration	
	Memory configuration	
	User(s)	
	<i>adm</i> password	
	Tags	
	IO Server config	
	Gateway config	
	Ewon Identification	
	User Web site	
	User Scripts	

A Connector Pinout & Related Specifications

A.1 Main Connector

As shown in the below picture, the female mating connector is labeled with the appropriate symbols.

Characteristic	Value
Connector type	MINICONNEC MC model Type MC 1.5 / 9-ST-3.5 Pitch = 3.50mm 9-pin female
Maximal tightening torque	0.25Nm <i>In the absence of a torque wrench, a soft manual tightening is sufficient</i>

PIN	ICON	ID	Description
1	O.	DO_COM	Output signal (0V ground) connected to the emitter of the MOSFET transistor
2	O	DO	Output signal connected to the drain of the MOSFET transistor
3	O ₊	DO_VDC	Common of the external predrive power supply (between +12 et +24 VDC)
4	I.	DI_COM	Ground of the input (isolated)
5	I ₁	DI1	Input signal 1
6	I ₂	DI2	Input signal 2
7	+	Power in VDD +	Between +12 and +24 VDC
8	-	Power in GND —	0V
9		Functional earth	



Fig. 15 Connector pinout

A.2 Specification of the External Power Supply

The Ewon Flexy 205 must be powered by a 12-24Vdc 100w max. certified for 60°C and for altitudes up to 2000m for conformity to the UL/IEC 62368-1 or by a safety Low Power Supply (LPS) in accordance with clause 2.5 of UL/IEC 60950-1 Ed2. Standard, 12-24Vdc, 30W min. Certified for 70°C and for altitudes up to 2000m. The safety LPS power supply is not part of the delivery.

Characteristic	Value
Power supply voltage	external 12-24 VDC +/- 20%
Max. input power	30W max.
Internal voltage protection	max 30V
Input protection	protected against polarity inversion

Suggested power supply:

- SIEMENS SITOP logo power 24V 2.5A 60W - Siemens order ref: 6EP1332-1SH43
- Equivalents of the above on the market

A.3 Digital Output & Digital Inputs

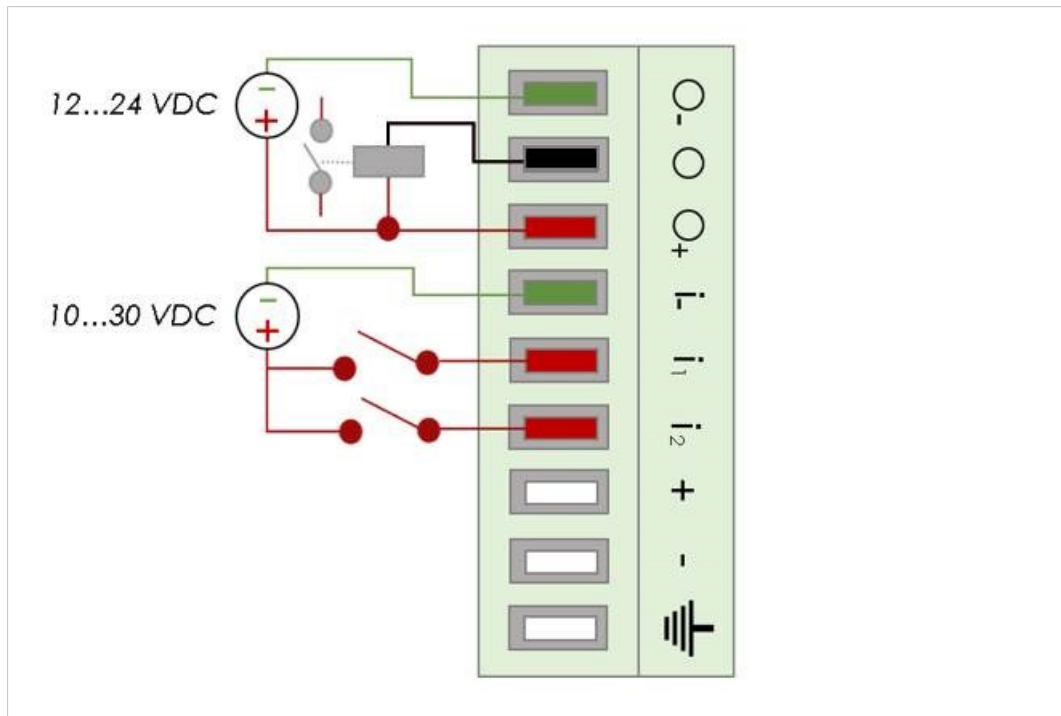

Fig. 16 Current scheme of the main connector

Characteristic	Value
Type of digital output ²	Open drain MOSFET
Maximum current (ext,source)	200 mA
Isolation (both DI & DO)	1.5 kV
DI voltage range	0 to 30 VDC
DI protection	33 VDC Max
DI OFF state — input voltage range	0 to 5 VDC
DI ON state — input voltage range	10 to 30 VDC
DI ON state — current range	From 3,8 mA @ 12 VDC to 8,2 mA @ 24 VDC

The Digital Output is activated by an open drain MOSFET transistor driven by an optocoupler. The maximum current flow inside this transistor has a value above the one specified in the Ewon, in order to cope with the switching power losses.

The transistor used is in an open drain type with predrive. This means the relay power supply has to be supplied from an external source to the predrive electronics.

The diagram below shows the external wiring needed for proper operation of the digital output. A relay has been chosen for this sample application but any load within the specifications can be used instead.



This is a sink only output to ground (the transistor acts as a switch ground).

2. During the starting boot process, the DO will be switched ON for a short time (2 seconds)

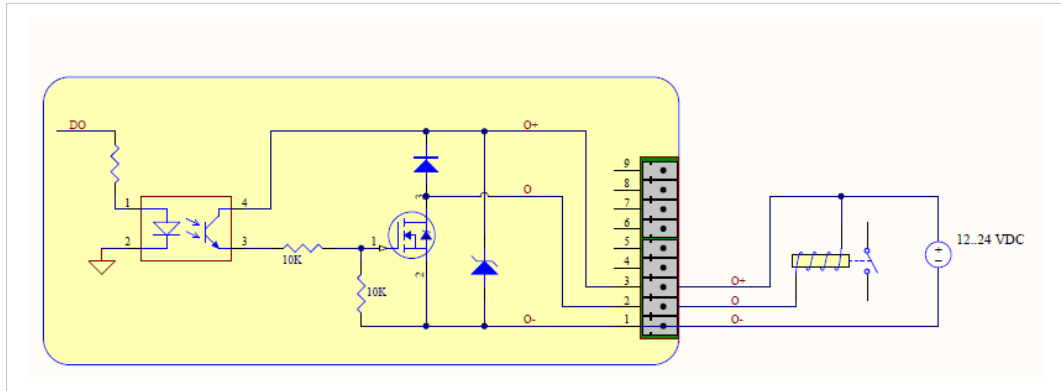

Fig. 17 External wiring for the Digital Output

A.3.1 Possible Features

Wiring the Digital Output & Inputs can be used to externalize some features (as connectivity condition) as described below:

LED	Connector	Description
KEY	DI1	Authorize or prevent the Internet connection.
		Authorize or prevent the VPN connection.
		Trigger an SMS or email notification.
DI2	DI2	Trigger an SMS or email notification.
T2M	DO	Can be wired to an external device to propagate the Talk2M status. If the VPN connection is active, the DO is set to 1.

The configuration of these conditions has to be done during the “DI Config” wizard which offers the opportunity whether the **Digital Input** should be used or not and for which purpose.

B Flexy 205 Products Overview

B.1 Extension Cards

Picture	Reference & name	Slot compatibility	Maximum supported	Installation Guide
 A blue printed circuit board (PCB) extension card with two RS-485 serial ports on the left side. The board is populated with various electronic components, including a red integrated circuit (IC) and several resistors. The model number 'FLA 3301' is printed at the bottom left.	FLA 3301 2 Serial-Ports	•••○	2	IG-0016-00
 A blue PCB extension card featuring a single RJ45 Ethernet port on the left. The board includes a red IC and other components. The model number 'FLX 3101' is visible at the bottom left.	FLX 3101 Ethernet 10/100	••••	1	IG-0017-00
 A blue PCB extension card with a green terminal block on the left side, providing 8 digital input (DI) and 2 digital output (DO) connections. A red IC is mounted on the board. The model number 'FLX 3401' is at the bottom left.	FLX 3401 8DI-4AI-2DO	••••	4	IG-0018-00
 A blue PCB extension card with a green terminal block on the left side, similar to the FLX 3401 but with a different internal configuration. A red IC is present. The model number 'FLX 3402' is at the bottom left.	FLX 3402 8DI-4AI-2DO	••••	4	IG-0018-01
 A blue PCB extension card with a black antenna on the left side, indicating 3G GSM functionality. The board features a red IC and other components. The model number 'FLB 3202' is at the bottom left.	FLB 3202 3G GSM	○•••	1	IG-0019-00

Picture	Reference & name	Slot compatibility	Maximum supported	Installation Guide
	FLB 3204 4G EU	oo●●	1	IG-0026-00
	FLB 3271 Wi-Fi	oo●●	1	IG-0020-00
	FLA 3501 PSTN	●●oo	1	IG-0021-00
	FLB 3601 USB	oo●●	1	IG-0024-00
	FLC 3701 MPI	oooo	1	Coming soon



Since July 2016, the FLX 3401 has been tagged as end of life and is replaced by the FLX 3402.

As explained in [Software Compatibility of Multiple Cards Combination, p. 19](#), the number of cards of the same type supported by the firmware is indicated in this table.

C Flexy 205 Isolation Scheme

C.1 Base Unit

	Flexy 205
Connector shielding	Earth connected
Ethernet signals	Isolated from DGNG with a transformer



Serial ports GND = DGND

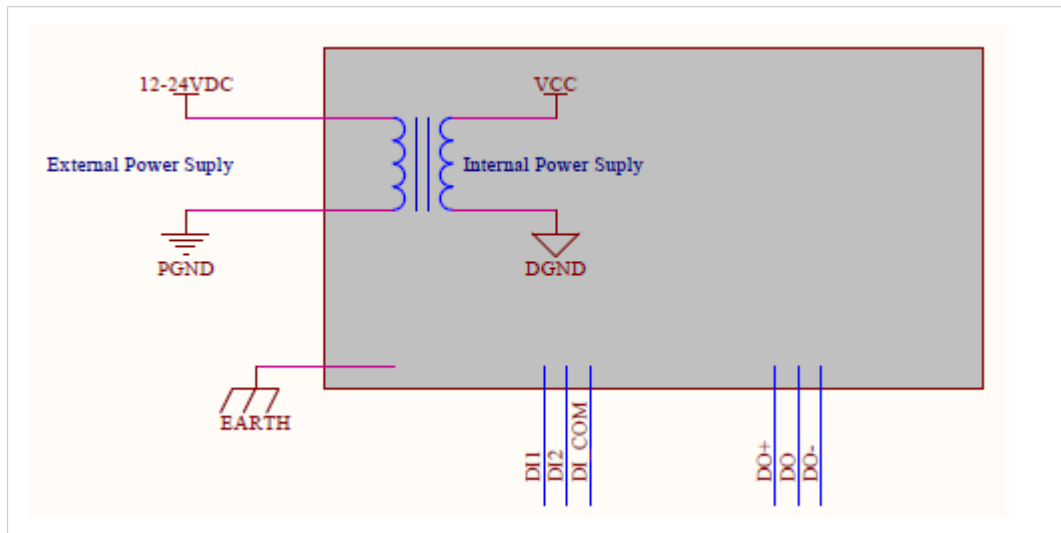

Fig. 18 Isolation Scheme for the Base Unit

Based on the above picture:

- External and internal power supplies are isolated from each other (1.5kV)
- DI signals: isolated from DO signals, PGND and DGND (optocoupler)
- DO signals: isolated from DI signals, PGND and DGND (optocoupler)
- Earth is isolated from external and internal power supplies

C.2 Extension Cards

C.2.1 FLB 320x – Cellular

DGND = GND RF from SMA connector



Avoid external connections between GND RF and Earth.

C.2.2 FLX 3101 – WAN Ethernet

Connector shielding: Earth connected

Ethernet signals: isolated from DGND with a transformer

C.2.3 FLX 3271 – Wi-Fi

DGND = GND RF from SMA connector



Avoid external connections between GND RF and Earth.

C.2.4 FLX 340x – I/O

DO signals: isolated relays outputs

DI signals: isolated from DGND (optocoupler)

AI signals: isolated from PGND only



AI-GND = DGND

C.2.5 FLA 3301 – Dual Serial Ports

Serial port signals: isolated from PGND only

Connector shielding: connected to Earth



Serial ports GND = DGND

C.2.6 FLC 3701 – MPI Port

MPI port signals: isolated from PGND only

Connector shielding: connected to Earth



MPI port GND = DGND

C.2.7 FLB 3601 – 3 USB Ports

USB signals: isolated from PGND only

Connector shielding: connected to Earth

Due to USB connector design, Earth-DGND isolation is limited to 500V when the USB extension card is inserted



AI-GND = DGND

