

# System MICRO

PS | M07-2BA00 | Manual

HB400 | PS | M07-2BA00 | en | 21-02

Power supply - PS M07



YASKAWA Europe GmbH  
Hauptstraße 185  
65760 Eschborn  
Germany  
Tel.: +49 6196 569-300  
Fax: +49 6196 569-398  
Email: [info@yaskawa.eu.com](mailto:info@yaskawa.eu.com)  
Internet: [www.yaskawa.eu.com](http://www.yaskawa.eu.com)

## Table of contents

<b>1</b>	<b>General</b> .....	<b>4</b>
1.1	Copyright © YASKAWA Europe GmbH.....	4
1.2	About this manual.....	6
1.3	Safety instructions.....	7
<b>2</b>	<b>Basics and mounting</b> .....	<b>8</b>
2.1	Safety information for users.....	8
2.2	System conception.....	9
2.3	Dimensions.....	10
2.4	Mounting.....	12
2.4.1	Mounting without mounting rail.....	13
2.4.2	Mounting with mounting rail.....	13
2.5	Wiring.....	15
2.5.1	Wiring power supply.....	15
2.6	Demounting.....	16
2.7	Industrial security and installation guidelines.....	19
2.7.1	Industrial security in information technology.....	19
2.7.2	Installation guidelines.....	21
2.8	General data.....	24
2.8.1	Use in difficult operating conditions.....	25
<b>3</b>	<b>Power supply</b> .....	<b>26</b>
3.1	Safety instructions.....	26
3.2	PS M07 DC24V, 1.5A_AC120V-240V.....	27
3.3	Technical data.....	29
	<b>Appendix</b> .....	<b>31</b>
A	History of changes.....	33

# 1 General

## 1.1 Copyright © YASKAWA Europe GmbH

### All Rights Reserved

This document contains proprietary information of Yaskawa and is not to be disclosed or used except in accordance with applicable agreements.

This material is protected by copyright laws. It may not be reproduced, distributed, or altered in any fashion by any entity (either internal or external to Yaskawa) except in accordance with applicable agreements, contracts or licensing, without the express written consent of Yaskawa and the business management owner of the material.

For permission to reproduce or distribute, please contact: YASKAWA Europe GmbH, European Headquarters, Hauptstraße 185, 65760 Eschborn, Germany

Tel.: +49 6196 569 300

Fax.: +49 6196 569 398

Email: [info@yaskawa.eu.com](mailto:info@yaskawa.eu.com)

Internet: [www.yaskawa.eu.com](http://www.yaskawa.eu.com)



*Every effort has been made to ensure that the information contained in this document was complete and accurate at the time of publishing. Nevertheless, the authors retain the right to modify the information.*

*This customer document describes all the hardware units and functions known at the present time. Descriptions may be included for units which are not present at the customer site. The exact scope of delivery is described in the respective purchase contract.*

### EC conformity declaration

Hereby, YASKAWA Europe GmbH declares that the products and systems are in compliance with the essential requirements and other relevant provisions. Conformity is indicated by the CE marking affixed to the product.

### Conformity Information

For more information regarding CE marking and Declaration of Conformity (DoC), please contact your local representative of YASKAWA Europe GmbH.

### Trademarks

VIPA, SLIO, System 100V, System 200V, System 300V, System 300S, System 400V, System 500S and Commander Compact are registered trademarks of YASKAWA Europe GmbH.

SPEED7 is a registered trademark of YASKAWA Europe GmbH.

SIMATIC, STEP, SINEC, TIA Portal, S7-300, S7-400 and S7-1500 are registered trademarks of Siemens AG.

Microsoft and Windows are registered trademarks of Microsoft Inc., USA.

Portable Document Format (PDF) and Postscript are registered trademarks of Adobe Systems, Inc.

All other trademarks, logos and service or product marks specified herein are owned by their respective companies.

### Document support

Contact your local representative of YASKAWA Europe GmbH if you have errors or questions regarding the content of this document. You can reach YASKAWA Europe GmbH via the following contact:

Email: [Documentation.HER@yaskawa.eu.com](mailto:Documentation.HER@yaskawa.eu.com)

**Technical support**

Contact your local representative of YASKAWA Europe GmbH if you encounter problems or have questions regarding the product. If such a location is not available, you can reach the Yaskawa customer service via the following contact:

YASKAWA Europe GmbH,  
European Headquarters, Hauptstraße 185, 65760 Eschborn, Germany  
Tel.: +49 6196 569 500 (hotline)  
Email: [support@yaskawa.eu.com](mailto:support@yaskawa.eu.com)

## 1.2 About this manual

**Objective and contents** The manual describes the power supply (PS) that can be used in the Yaskawa System MICRO. Described are construction, application and technical data.

Product	Order no.	as of HW state:
PS M07 DC24V, 1.5A_AC120V-240V	M07-2BA00	01

**Target audience** The manual is targeted at users who have a background in automation technology.

**Structure of the manual** The manual consists of chapters. Every chapter provides a self-contained description of a specific topic.

**Guide to the document** The following guides are available in the manual:

- An overall table of contents at the beginning of the manual
- References with page numbers

**Availability** The manual is available in:

- printed form, on paper
- in electronic form as PDF-file (Adobe Acrobat Reader)

**Icons Headings** Important passages in the text are highlighted by following icons and headings:



### **DANGER!**

Immediate or likely danger. Personal injury is possible.



### **CAUTION!**

Damages to property is likely if these warnings are not heeded.



*Supplementary information and useful tips.*

### 1.3 Safety instructions

#### Warning symbol on the housing



#### **DANGER!**

There is a warning symbol on the housing of the power supply. This indicates that all safety instructions listed in this manual must be observed before commissioning!

#### Intended use



#### **DANGER!**

Failure to comply with the specification may affect the protective functions of the system!

The power supply is constructed and produced for:

- the DC 24V supply of components.
- operation within the environmental conditions specified in the technical data
- the installation on a 35mm mounting rail in a control cabinet, which provides protection against fire, environmental influences and mechanical impact
- industrial applications



#### **DANGER!**

This device is not certified for applications in

- in explosive environments (EX-zone)

#### Documentation

The manual must be available to all personnel in the

- project design department
- installation department
- commissioning
- operation



#### **CAUTION!**

**The following conditions must be met before using or commissioning the components described in this manual:**

- Hardware modifications should only be carried out when the system has been disconnected from power!
- Installation and hardware modifications only by properly trained personnel.
- The national rules and regulations of the respective country must be satisfied (installation, safety, EMC ...)

#### Disposal

**National rules and regulations apply to the disposal of the unit!**

## 2 Basics and mounting

### 2.1 Safety information for users

#### Handling of electrostatic sensitive modules

The modules make use of highly integrated components in MOS-Technology. These components are extremely sensitive to over-voltages that can occur during electrostatic discharges. The following symbol is attached to modules that can be destroyed by electrostatic discharges.



The Symbol is located on the module, the module rack or on packing material and it indicates the presence of electrostatic sensitive equipment. It is possible that electrostatic sensitive equipment is destroyed by energies and voltages that are far less than the human threshold of perception. These voltages can occur where persons do not discharge themselves before handling electrostatic sensitive modules and they can damage components thereby, causing the module to become inoperable or unusable. Modules that have been damaged by electrostatic discharges can fail after a temperature change, mechanical shock or changes in the electrical load. Only the consequent implementation of protection devices and meticulous attention to the applicable rules and regulations for handling the respective equipment can prevent failures of electrostatic sensitive modules.

#### Shipping of modules

Modules must be shipped in the original packing material.

#### Measurements and alterations on electrostatic sensitive modules

When you are conducting measurements on electrostatic sensitive modules you should take the following precautions:

- Floating instruments must be discharged before use.
- Instruments must be grounded.

Modifying electrostatic sensitive modules you should only use soldering irons with grounded tips.



#### CAUTION!

Personnel and instruments should be grounded when working on electrostatic sensitive modules.



## 2.2 System conception

### Overview

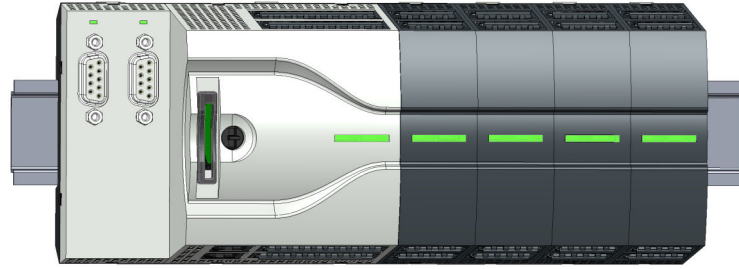

The System MICRO is a modular automation system for assembly on a 35mm mounting rail. By means of periphery modules this system may be adapted matching to your automation tasks. In addition, it is possible to expand your CPU by appropriate interfaces. The wiring complexity is low, because the DC 24V electronic section supply is integrated to the backplane bus and this allows replacement with standing wire.

### Components

- CPU
- Extension module
- Power supply
- Periphery module

### CPU

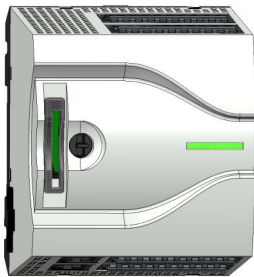

With the CPU electronic, input/output components and power supply are integrated to one casing. In addition, up to 8 periphery modules of the System MICRO can be connected to the backplane bus. As head module via the integrated power module for power supply CPU electronic and the I/O components are supplied as well as the electronic of the periphery modules, which are connected via backplane bus. To connect the power supply of the I/O components and for DC 24V electronic power supply of the periphery modules, which are connected via backplane bus, the CPU has removable connectors. By installing of up to 8 periphery modules at the backplane bus of the CPU, these are electrically connected, this means these are assigned to the backplane bus and connected to the DC 24V electronic power supply.

### Extension module



By using extension modules you can extend the interfaces of the CPU. The attachment to the CPU is made by plugging on the left side of the CPU. You can only connect one extension module to the CPU at a time.

Dimensions

**Power supply**



The power supply is mounted on the left side from the DIN rail with the System MICRO modules. It serves for electronics and power supply.

**Periphery module**



By means of up to 8 periphery modules, you can extend the internal I/O areas. The attachment to the CPU is made by plugging them on the right side of the CPU.

**2.3 Dimensions**

**Dimensions CPU M13C**

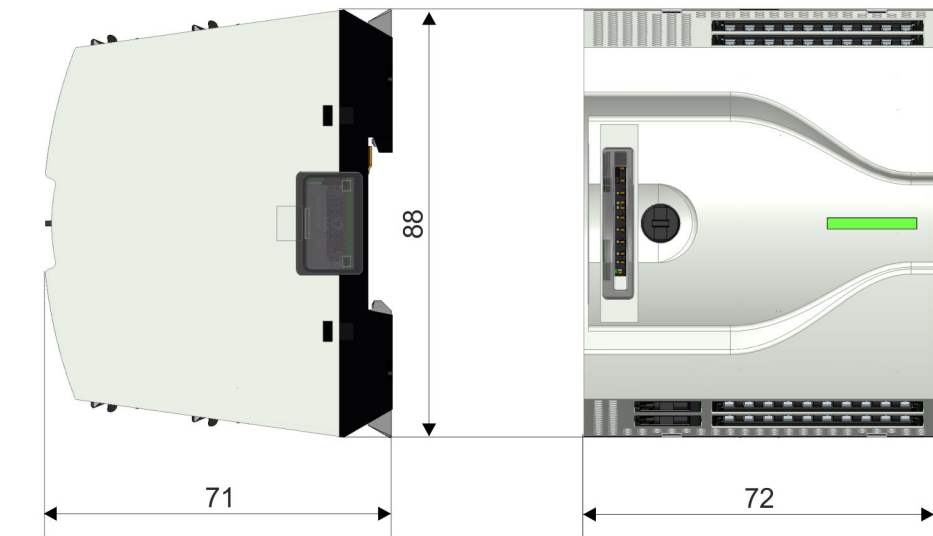

Dimensions in mm

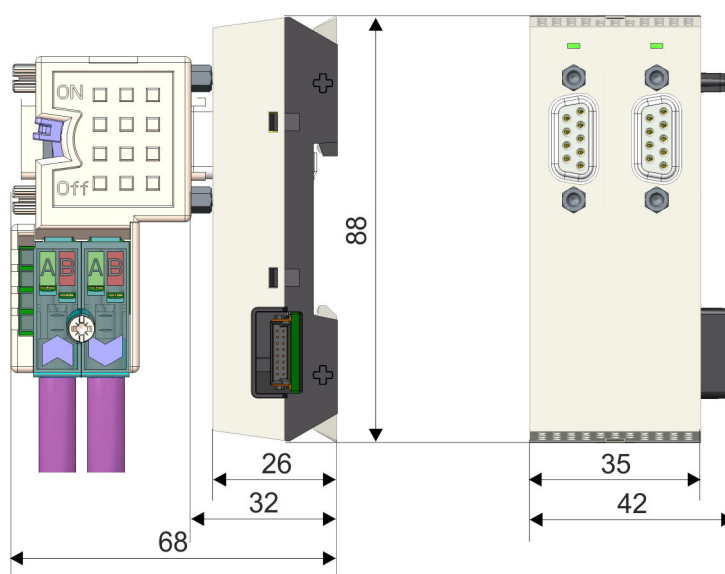
**Dimensions extension  
module EM M09**

Dimensions in mm

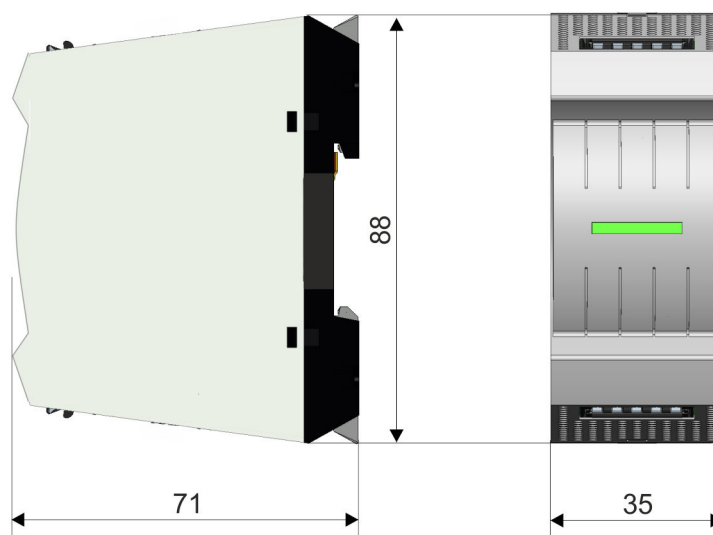
**Dimensions power supply**

**Dimensions periphery module**

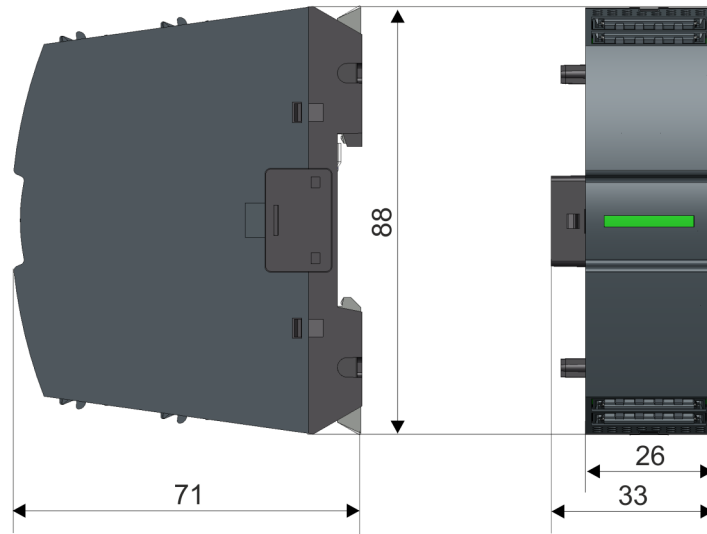

Dimensions in mm

**2.4 Mounting**



**Observe minimum distance!**

*For operation within the specified nominal values, they must comply with a minimum distance of 30 mm on one side of the module!*

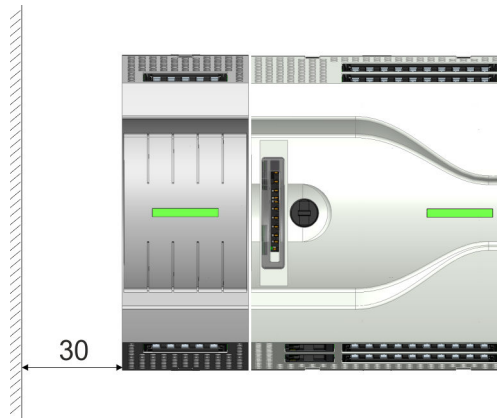

Dimensions in mm

### 2.4.1 Mounting without mounting rail

#### Proceeding

You can screw the power supply to the back wall by means of screws via the locking levers. The happens with the following proceeding:

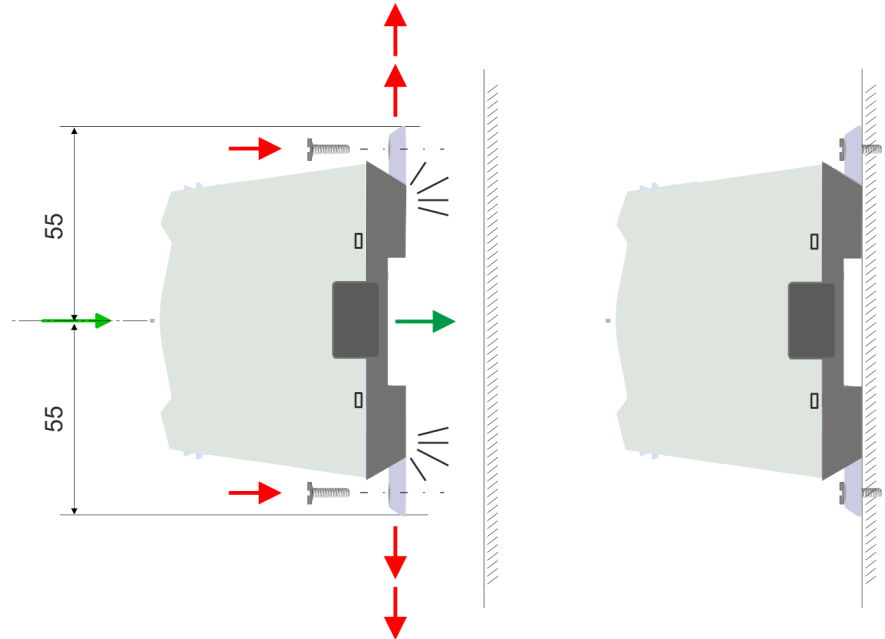

Dimensions in mm

1. ➤ The power supply has a locking lever on the upper and lower side. Pull these levers outwards as shown in the figure, until these engage 2x audible.
  - ⇨ By this openings on the locking levers get visible.
2. ➤ Use this openings to fix your power supply to your back wall with appropriate screws. Consider the installation clearances for the power supply.
  - ⇨ The power supply is now mounted and can be wired.

### 2.4.2 Mounting with mounting rail

#### Proceeding

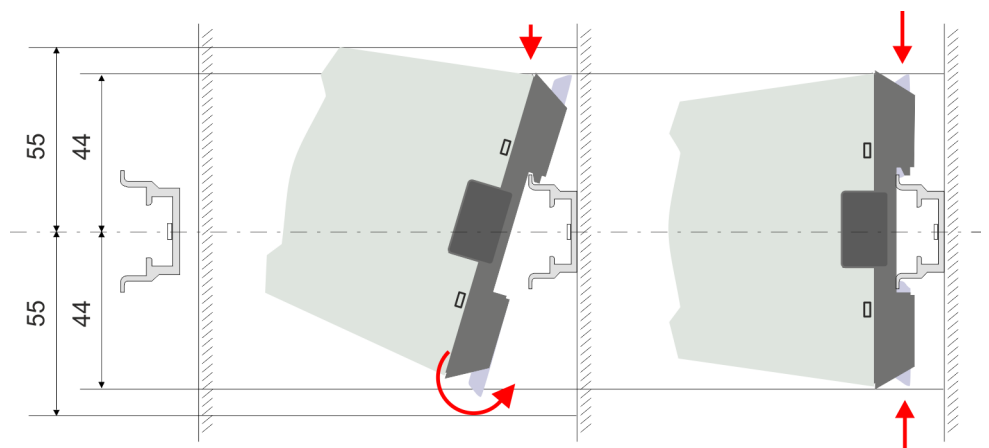

Dimensions in mm

1. ➤ Mount the mounting rail. Please consider that a clearance from the middle of the mounting rail of at least 44mm respectively 55mm above and below exists.

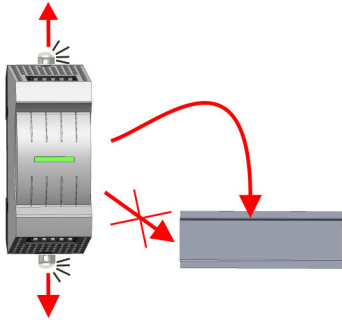

2. → The power supply has a locking lever on the upper and lower side. Pull these levers outwards as shown in the figure, until these engage audible.



**CAUTION!**

It is not allowed to mount the module sideways on the mounting rail, as otherwise the module may be damaged.

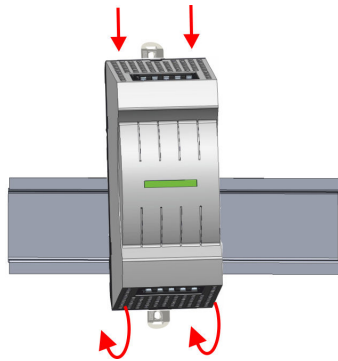

3. → Plug the power supply from the top onto the mounting rail and turn the power supply downward until it rests on the mounting rail.

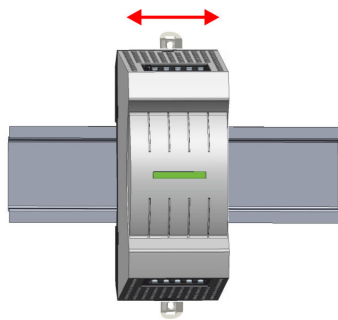

4. → Move the power supply on the mounting rail at its position.

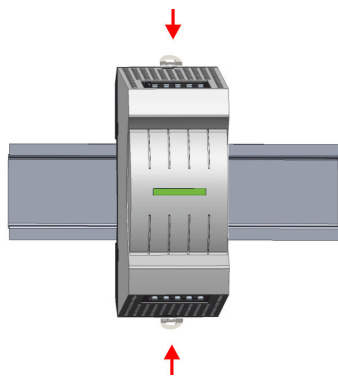

5. → To fix the power supply at the mounting rail, move the locking levers back to the initial position.  
 ⇨ The power supply is now mounted and can be wired.

## 2.5 Wiring



### DANGER!

#### Consider strain relief of the supply lines!

Since the plug for the supply lines of the input voltage has no (double) insulation, not permanently fixed supply lines must be relieved from push and pull!



### CAUTION!

#### Consider temperature for external cables!

Cables may experience temperature increase due to system heat dissipation. Thus the cabling specification must be chosen 25°C above ambient temperature!



### CAUTION!

#### Separate insulation areas!

The system is specified for SELV/PELV environment. Devices, which are attached to the system must meet these specifications. Installation and cable routing other than SELV/PELV specification must be separated from the system's equipment!

### 2.5.1 Wiring power supply

#### Connectors

For wiring the power supply has removable connectors. With the wiring of the connectors a "push-in" spring-clip technique is used. This allows a quick and easy connection of your supply lines. The clamping off takes place by means of a screwdriver.

#### Data

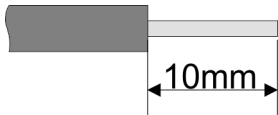

$U_{max}$	240V AC / 30V DC
$I_{max}$	2A
Cross section	0.2 ... 1.5mm <sup>2</sup> (AWG 24 ... 16)
Stripping length	10mm

Use for wiring rigid wires respectively use wire sleeves. When using stranded wires you have to press the release button with a screwdriver during the wiring.

#### Wiring procedure

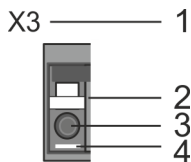

- 1 Labeling on the casing
- 2 Release area
- 3 Connection hole for wire
- 4 Pin 1 of the connector is labelled by a white line.

Demounting

Insert wire

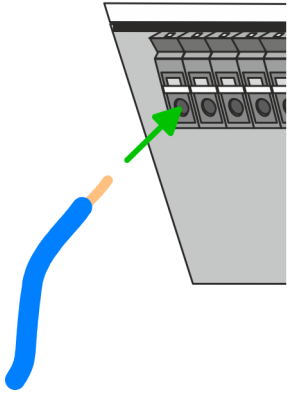

The wiring happens without a tool.

- ➔ Determine according to the casing labelling the connection position and insert through the round connection hole of the according contact your prepared wire until it stops, so that it is fixed.
- ⇒ By pushing the contact spring opens, thus ensuring the necessary contact pressure.

Remove wire

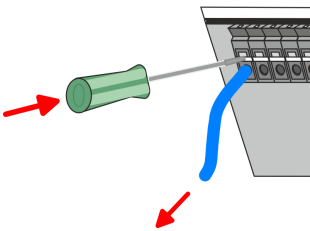

The wire is to be removed by means of a screwdriver with 2.5mm blade width.

1. ➔ Press with your screwdriver vertically at the release button.
  - ⇒ The contact spring releases the wire.
2. ➔ Pull the wire from the round hole.

Fusing



**CAUTION!**

To protect the power supply lines, you should use a circuit breaker with the following characteristics:

- Rated current at AC 230V: 4A
- Tripping characteristic: C

2.6 Demounting

Remove connector

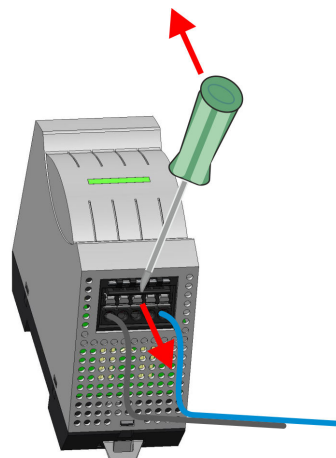

By means of a screwdriver there is the possibility to remove the connectors e.g. for module exchange with a fix wiring. For this each connector has indentations for unlocking at the top. Unlocking takes place by the following proceeding:

1. ➔ Remove connector:  
Insert your screwdriver from above into one of the indentations.



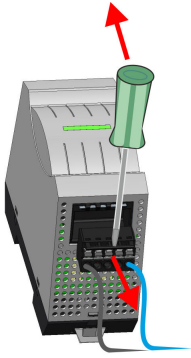

2. ➤ Push the screwdriver backwards:
  - ⇒ The connector is unlocked and can be removed.

**CAUTION!**

Via wrong operation such as pressing the screwdriver downward, the release lever may be damaged.

3. ➤ In this way, remove all plugged connectors on the power supply.

**Power supply replacement****Replacement on mounting rail**

The replacement of the power supply on the mounting rail happens with the following proceeding:

1. ➤ Use a screwdriver to pull the locking levers of the power supply outwards until these engage audible.

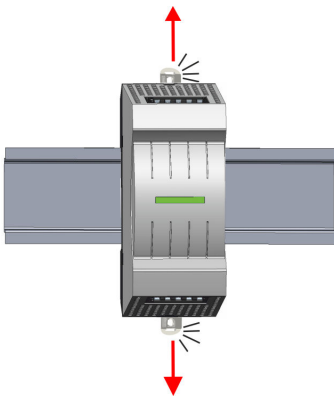

2. ➤ Remove the power supply with a rotation upwards from the mounting rail.

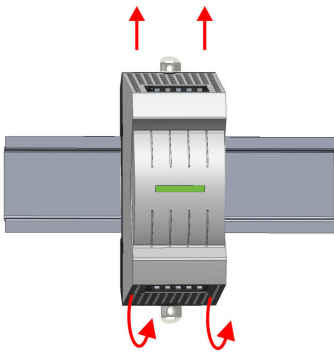

3. ➤ Pull the locking levers of the new power supply outwards until these engage audible. Plug the power supply from the top onto the mounting rail and turn the power supply downward until it rests on the mounting rail.

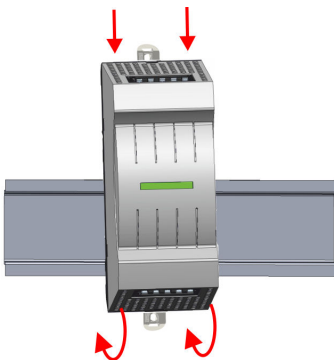
**CAUTION!**

It is not allowed to mount the module sideways on the mounting rail, as otherwise the module may be damaged!

Demounting

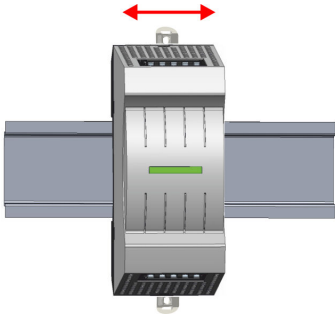

**4.** → Move the power supply on the mounting rail at its position.

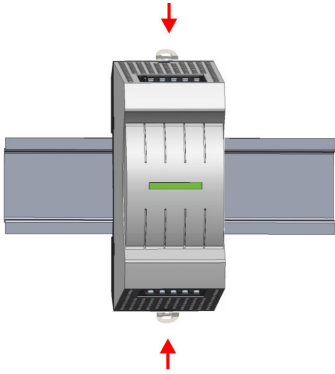

**5.** → To fix the power supply at the mounting rail, move the locking levers back to the initial position.

⇒ The power supply is now mounted and can be wired.

**Plug connector**

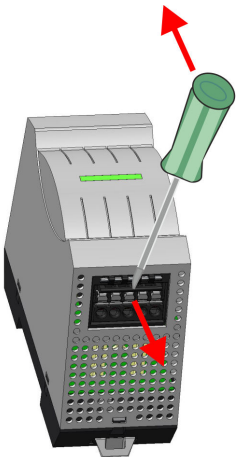

**1.** → Remove the connectors, which are not necessary at the power supply.

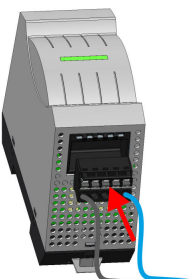

**2.** → Plug again the wired connectors.

⇒ Now you can bring your system back into operation.

## 2.7 Industrial security and installation guidelines

### 2.7.1 Industrial security in information technology

#### Latest version

This chapter can also be found as a guide '*Industrial IT Security*' at [www.yaskawa.eu.com](http://www.yaskawa.eu.com)

#### Hazards

The topic of data security and access protection has become increasingly important in the industrial environment. The increased networking of entire industrial systems to the network levels within the company together with the functions of remote maintenance have all served to increase vulnerability. Hazards can arise from:

- Internal manipulation such as technical errors, operating and program errors and deliberate program or data manipulation.
- External manipulation such as software viruses, worms and Trojans.
- Human carelessness such as password phishing.

#### Precautions

The most important precautions to prevent manipulation and loss of data security in the industrial environment are:

- Encrypting the data traffic by means of certificates.
- Filtering and inspection of the traffic by means of VPN - "Virtual Private Networks".
- Identification of the user by "Authentication" via safe channels.
- Segmenting in protected automation cells, so that only devices in the same group can exchange data.
- Deactivation of unnecessary hardware and software.

#### Further Information

You can find more information about the measures on the following websites:

- Federal Office for Information Technology [www.bsi.bund.de](http://www.bsi.bund.de)
- Cybersecurity & Infrastructure Security Agency [us-cert.cisa.gov](http://us-cert.cisa.gov)
- VDI / VDE Society for Measurement and Automation Technology [www.vdi.de](http://www.vdi.de)

### 2.7.1.1 Protection of hardware and applications

#### Precautions

- Do not integrate any components or systems into public networks.
  - Use VPN "Virtual Private Networks" for use in public networks. This allows you to control and filter the data traffic accordingly.
- Always keep your system up-to-date.
  - Always use the latest firmware version for all devices.
  - Update your user software regularly.
- Protect your systems with a firewall.
  - The firewall protects your infrastructure internally and externally.
  - This allows you to segment your network and isolate entire areas.
- Secure access to your plants via user accounts.
  - If possible, use a central user management system.
  - Create a user account for each user for whom authorization is essential.
  - Always keep user accounts up-to-date and deactivate unused user accounts.
- Secure access to your plants via secure passwords.
  - Change the password of a standard login after the first start.
  - Use strong passwords consisting of upper/lower case, numbers and special characters. The use of a password generator or manager is recommended.
  - Change the passwords according to the rules and guidelines that apply to your application.
- Deactivate inactive communication ports respectively protocols.
  - Only the communication ports that are used for communication should be activated.
  - Only the communication protocols that are used for communication should be activated.
- Consider possible defence strategies when planning and securing the system.
  - The isolation of components alone is not sufficient for comprehensive protection. An overall concept is to be drawn up here, which also provides defensive measures in the event of a cyber attack.
  - Periodically carry out threat assessments. Among others, a comparison is made here between the protective measures taken and those required.
- Limit the use of external storage media.
  - Via external storage media such as USB memory sticks or SD memory cards, malware can get directly into a system while bypassing a firewall.
  - External storage media or their slots must be protected against unauthorized physical access, e.g. by using a lockable control cabinet.
  - Make sure that only authorized persons have access.
  - When disposing of storage media, make sure that they are safely destroyed.
- Use secure access paths such as HTTPS or VPN for remote access to your plant.
- Enable security-related event logging in accordance with the applicable security policy and legal requirements for data protection.

### 2.7.1.2 Protection of PC-based software

#### Precautions

Since PC-based software is used for programming, configuration and monitoring, it can also be used to manipulate entire systems or individual components. Particular caution is required here!

- Use user accounts on your PC systems.
  - If possible, use a central user management system.
  - Create a user account for each user for whom authorization is essential.
  - Always keep user accounts up-to-date and deactivate unused user accounts.
- Protect your PC systems with secure passwords.
  - Change the password of a standard login after the first start.
  - Use strong passwords consisting of upper/lower case, numbers and special characters. The use of a password generator or manager is recommended.
  - Change the passwords according to the rules and guidelines that apply to your application.
- Enable security-related event logging in accordance with the applicable security policy and legal requirements for data protection.
- Protect your PC systems by security software.
  - Install virus scanners on your PC systems to identify viruses, trojans and other malware.
  - Install software that can detect phishing attacks and actively prevent them.
- Always keep your software up-to-date.
  - Update your operating system regularly.
  - Update your software regularly.
- Make regular backups and store the media at a safe place.
- Regularly restart your PC systems. Only boot from storage media that are protected against manipulation.
- Use encryption systems on your storage media.
- Perform security assessments regularly to reduce the risk of manipulation.
- Use only data and software from approved sources.
- Uninstall software which is not used.
- Disable unused services.
- Activate a password-protected screen lock on your PC systems.
- Always lock your PC systems as soon as you leave your PC workstation.
- Do not click any links that come from unknown sources. If necessary ask, e.g. on e-mails.
- Use secure access paths such as HTTPS or VPN for remote access to your PC system.

### 2.7.2 Installation guidelines

#### General

The installation guidelines contain information about the interference free deployment of a PLC system. There is the description of the ways, interference may occur in your PLC, how you can make sure the electromagnetic compatibility (EMC), and how you manage the isolation.

#### What does EMC mean?

Electromagnetic compatibility (EMC) means the ability of an electrical device, to function error free in an electromagnetic environment without being interfered respectively without interfering the environment.

The components are developed for the deployment in industrial environments and meets high demands on the EMC. Nevertheless you should project an EMC planning before installing the components and take conceivable interference causes into account.

**Possible interference causes**

Electromagnetic interferences may interfere your control via different ways:

- Electromagnetic fields (RF coupling)
- Magnetic fields with power frequency
- Bus system
- Power supply
- Protected earth conductor

Depending on the spreading medium (lead bound or lead free) and the distance to the interference cause, interferences to your control occur by means of different coupling mechanisms.

There are:

- galvanic coupling
- capacitive coupling
- inductive coupling
- radiant coupling

**Basic rules for EMC**

In the most times it is enough to take care of some elementary rules to guarantee the EMC. Please regard the following basic rules when installing your PLC.

- Take care of a correct area-wide grounding of the inactive metal parts when installing your components.
  - Install a central connection between the ground and the protected earth conductor system.
  - Connect all inactive metal extensive and impedance-low.
  - Please try not to use aluminium parts. Aluminium is easily oxidizing and is therefore less suitable for grounding.
- When cabling, take care of the correct line routing.
  - Organize your cabling in line groups (high voltage, current supply, signal and data lines).
  - Always lay your high voltage lines and signal respectively data lines in separate channels or bundles.
  - Route the signal and data lines as near as possible beside ground areas (e.g. suspension bars, metal rails, tin cabinet).
- Proof the correct fixing of the lead isolation.
  - Data lines must be shielded.
  - Analog lines must be shielded. When transmitting signals with small amplitudes the one sided laying of the isolation may be favourable.
  - Cables for frequency inverters, servo and stepper motors must be shielded.
  - Lay the line isolation extensively on an isolation/protected earth conductor rail directly after the cabinet entry and fix the isolation with cable clamps.
  - Make sure that the isolation/protected earth conductor rail is connected impedance-low with the cabinet.
  - Use metallic or metallised plug cases for isolated data lines.
- In special use cases you should appoint special EMC actions.
  - Consider to wire all inductivities with erase links.
  - Please consider luminescent lamps can influence signal lines.
- Create a homogeneous reference potential and ground all electrical operating supplies when possible.
  - Please take care for the targeted employment of the grounding actions. The grounding of the PLC serves for protection and functionality activity.
  - Connect installation parts and cabinets with your PLC in star topology with the isolation/protected earth conductor system. So you avoid ground loops.
  - If there are potential differences between installation parts and cabinets, lay sufficiently dimensioned potential compensation lines.

**Isolation of conductors**

Electrical, magnetically and electromagnetic interference fields are weakened by means of an isolation, one talks of absorption. Via the isolation rail, that is connected conductive with the rack, interference currents are shunt via cable isolation to the ground. Here you have to make sure, that the connection to the protected earth conductor is impedance-low, because otherwise the interference currents may appear as interference cause.

When isolating cables you have to regard the following:

- If possible, use only cables with isolation tangle.
- The hiding power of the isolation should be higher than 80%.
- Normally you should always lay the isolation of cables on both sides. Only by means of the both-sided connection of the isolation you achieve high quality interference suppression in the higher frequency area. Only as exception you may also lay the isolation one-sided. Then you only achieve the absorption of the lower frequencies. A one-sided isolation connection may be convenient, if:
  - the conduction of a potential compensating line is not possible.
  - analog signals (some mV respectively  $\mu\text{A}$ ) are transferred.
  - foil isolations (static isolations) are used.
- With data lines always use metallic or metallised plugs for serial couplings. Fix the isolation of the data line at the plug rack. Do not lay the isolation on the PIN 1 of the plug bar!
- At stationary operation it is convenient to strip the insulated cable interruption free and lay it on the isolation/protected earth conductor line.
- To fix the isolation tangles use cable clamps out of metal. The clamps must clasp the isolation extensively and have well contact.
- Lay the isolation on an isolation rail directly after the entry of the cable in the cabinet. Lead the isolation further on to your PLC and don't lay it on there again!

**CAUTION!****Please regard at installation!**

At potential differences between the grounding points, there may be a compensation current via the isolation connected at both sides.

Remedy: Potential compensation line

## General data

## 2.8 General data

Conformity and approval		
Conformity		
CE	2014/35/EU	Low-voltage directive
	2014/30/EU	EMC directive
Approval		
UL	-	Refer to Technical data
others		
RoHS	2011/65/EU	Restriction of the use of certain hazardous substances in electrical and electronic equipment

Protection of persons and device protection		
Type of protection	-	IP20
Electrical isolation		
Safe insulation	-	between primary and secondary side
Insulation voltage to reference earth		
Inputs / outputs	-	
Protective measures	-	against short circuit

Environmental conditions to EN 61131-2		
Climatic		
Storage / transport	EN 60068-2-14	-40...+80°C
Operation		
Horizontal installation hanging	EN 61131-2	0...+60°C
Vertical installation	EN 61131-2	0...+50°C
Air humidity	EN 60068-2-30	RH1 (without condensation, rel. humidity 5...95%)
Pollution	EN 61131-2	Degree of pollution 2
Installation altitude max.	-	2000m
Mechanical		
Oscillation	EN 60068-2-6	1g, 9Hz ... 150Hz
Shock	EN 60068-2-27	15g, 11ms

Mounting conditions		
Mounting place	-	In the control cabinet
Mounting position	-	Horizontal and vertical



EMC	Standard	Comment
Overvoltage category	EN 50178	III
	UL 61010-1	II
Emitted interference	EN 61000-6-4	Class A (Industrial area)
Noise immunity zone B	EN 61000-6-2	Zone B (Industrial area)
	EN 61000-4-2	ESD 8kV at air discharge (degree of severity 3), 6kV at contact discharge (degree of severity 3)
	EN 61000-4-3	HF field immunity (casing) 80MHz ... 1000MHz, 10V/m, 80% AM (1kHz) 1.4GHz ... 6.0GHz, 3V/m, 80% AM (1kHz)
	EN 61000-4-6	HF conducted 150kHz ... 80MHz, 10V, 80% AM (1kHz)
	EN 61000-4-4	Burst, degree of severity 3
	EN 61000-4-5	Surge, degree of severity 3
	EN 61000-4-11	Mains voltage dips and interruptions

### 2.8.1 Use in difficult operating conditions



*Without additional protective measures, the products must not be used in locations with difficult operating conditions; e.g. due to:*

- *dust generation*
- *chemically active substances (corrosive vapors or gases)*
- *strong electric or magnetic fields*

## 3 Power supply

### 3.1 Safety instructions

#### Mounting

For the power supply applies:

- It is mounted together with your System MICRO modules on a DIN rail. In this case, the power supply must always be mounted only on the outer edge of your System MICRO, otherwise the backplane bus is interrupted. The power supply has no connection to the backplane bus.
- When selecting the mounting location, please note that the power supply is sufficiently cooled during operation.

Below are the precautions to take when using the power supply.



#### CAUTION!

- The power supply may only be installed in dry rooms, which are only accessible by the maintenance engineer!
- The power supply is not approved for use in potentially explosive environments (EX zone)!
- Before you start to work on at the power supply for installation or maintenance, you have to disconnect it from the main power source, i.e. the power line is to be switched off (unplug the plug, with permanent connection the associated fuse must be removed)!
- Only properly qualified electrical staff is allowed to install, connect and/or modify electrical equipment!
- Due to the compact design, the contact and fire protection can not be maintained to ensure sufficient cooling. For this reason, fire protection must be ensured by the construction of the environment of the installed power supply unit (e.g. installation in a control cabinet that complies with the fire protection regulations)!
- Please adhere to the national rules and regulations of the location and/or country where the units are installed (installation, safety precautions, EMC ...).



*Information about assembly and cabling ↪ Chap. 2 'Basics and mounting' page 8.*

## 3.2 PS M07 DC24V, 1.5A\_AC120V-240V

### Properties



- Output current 1.5A
- Rated output voltage DC 24V
- Connection to single-phase AC mains wide-range input AC 120...240V without manual switching
- Protection against short circuit and overload
- Can be used together with System MICRO on the rail
- Safe electrical isolation according to EN 60950
- Overtemperature protection
- Efficiency typ. 90% at  $I_{\text{nominal}}$
- Can be used as electronic and power section supply

### Ordering data

Type	Order number	Description
PS M07 DC24V, 1.5A_AC120V-240V	M07-2BA00	Power supply primary AC 120...240V, secondary DC 24V, 1.5A

### Structure

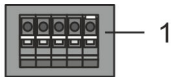

- 1 X1: Terminal DC 24V output, max. 1.5A
- 2 X3: Terminal AC 120...240V input, 47...63Hz, max. 0.9A
- 3 Status bar power module

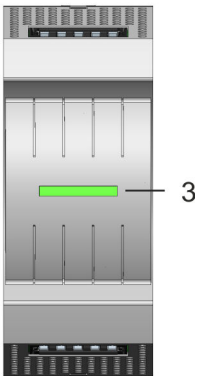

#### CAUTION!

- The power supplies must be released before installation and repair tasks, i.e. before handling with the power supply or with the cabling you must disconnect current/voltage (pull plug, at fixed connection switch off the concerning fuse)!
- Installation and modifications only by properly trained personnel!

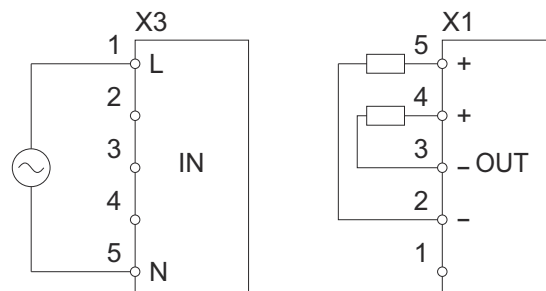

### Status bar

LED	Description
	LEDs off: Input voltage too low, power supply does not start.
	LEDs green on: OK: There is no fault and the DC 24V power supply is ensured.
	LED red on: Overload: The module is overheated or overloaded (short circuit).

Connection



- The power supply is to be supplied with AC 120 ... 240V via plug connector X3.
- A melting fuse protects the input against overload.
- The DC 24V output plug connector X1 is divided into 2 connectors each. Here you can connect your components, which are to be supplied externally with DC 24V.
- The DC 24V output is short-circuit proof with an output voltage of DC 24V at a total current of max. 1.5A
- Pin 1 of the connector is labelled by a white line.

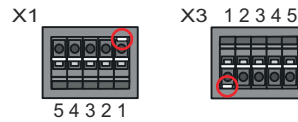

**i** To protect the power supply lines, you should use a circuit breaker with the following characteristics:

- Rated current at AC 230V: 4A
- Tripping characteristic: C

So that the circuit breaker can be easily replaced or reset, this should be mounted easily accessible.

**i** You can also supply the power supply with DC 120 ... 240V. Please note that use with DC 120 ... 240V does not correspond to UL-compliant operation.

Operation outside the nominal values

**i** In applications according to CE approval, operation outside the nominal values is permissible, but not in applications according to UL approval!

Regarding the following temperature ranges, operation outside the nominal values is possible

Output current	1.5A		2A	
Input voltage AC	100 ... 119V	100 ... 119V	120 ... 240V	
Ambient temperature (horizontal installation)	0 ... 55°C	0 ... 35°C	0 ... 45°C	
Ambient temperature (vertical installation)	0 ... 50°C	0 ... 30°C	0 ... 40°C	

Output current	1.5A		2A	
Input voltage DC	110 ... 119V	110 ... 119V	120 ... 345V	
Ambient temperature (horizontal installation)	0 ... 55°C	0 ... 35°C	0 ... 45°C	
Ambient temperature (vertical installation)	0 ... 50°C	0 ... 30°C	0 ... 40°C	

### 3.3 Technical data

Order no.	M07-2BA00
Type	PS M07
Module ID	-
<b>Technical data power supply</b>	
Input voltage (rated value)	AC 120...240V
Input voltage (permitted range)	AC 90...264 V
Mains frequency (rated value)	50...60 Hz
Mains frequency (permitted range)	47...63 Hz
Input current (at 120 V)	0.9 A
Input current (at 230 V)	0.6 A
Inrush current (at 25 °C)	30 A
I <sup>2</sup> t	-
Power consumption typ.	41 W
Output voltage (rated value)	24 V
Output current (rated value)	1.5 A
Power supply parallel switchable	-
Protect type	short circuits, overload
Ripple of output voltage (max.), BW=20 MHz	25 mV
Efficiency typ.	88 %
Power loss typ.	5 W
<b>Status information, alarms, diagnostics</b>	
Status display	yes
Interrupts	no
Process alarm	no
Diagnostic interrupt	no
Diagnostic functions	no
Diagnostics information read-out	none
Supply voltage display	none
Group error display	none
Channel error display	none
<b>Housing</b>	
Material	PC / PPE GF10
Mounting	Profile rail 35 mm
<b>Mechanical data</b>	
Dimensions (WxHxD)	35 mm x 88 mm x 71 mm
Net weight	155 g

## Technical data

<b>Order no.</b>	<b>M07-2BA00</b>
Weight including accessories	155 g
Gross weight	170 g
<b>Environmental conditions</b>	
Operating temperature	0 °C to 60 °C
Storage temperature	-40 °C to 80 °C
<b>Certifications</b>	
UL certification	yes
KC certification	in preparation

## Appendix

## Content

<b>A</b>	<b>History of changes.....</b>	<b>33</b>
----------	--------------------------------	-----------



## A History of changes

Rev.	Changes
20-02	The manual was created.
21-01	The description for the connection was revised.