

PROFIBUS-INspektor[®] NT

User Manual



Diagnostic and service tools for PROFIBUS

Revision overview

Date	Revision	Change(s)
04.06.2015	0	First version
30.06.2016	1	Firmware Update 1.5

© Copyright 2016 Indu-Sol GmbH

We reserve the right to amend this document without notice. We continuously work on further developing our products. We reserve the right to make changes to the scope of supply in terms of form, features and technology. No claims can be derived from the specifications, illustrations or descriptions in this documentation. Any kind of reproduction, subsequent editing or translation of this document, as well as excerpts from it, requires the written consent of Indu-Sol GmbH. All rights under copyright law are expressly reserved for Indu-Sol GmbH.

Caution!

This device may only be put into operation and operated by qualified personnel. Qualified personnel, as referred to in the safety-related information of this manual, are persons who are authorised to put into operation, to earth and to label devices, systems and electrical circuits in accordance with the standards of safety engineering.

Contents

Revision overview	3
Contents 4	
1 General information	6
1.1 Purpose of use	6
1.2 Scope of supply	7
1.3 Safety information	7
2 Device ports and status indicators	8
2.1 Device ports	8
2.2 Status LED	8
3 Installation	9
3.1 Installation instructions	9
3.2 Voltage supply	10
3.3 Measurement location	10
3.4 Connection to the PROFIBUS network	10
3.4.1 Connection with active programming cable	11
3.4.2 Installation at the end of the segment	11
3.4.3 Looping into an existing system	12
3.5 LAN connection	13
3.6 Signal inputs and outputs	13
3.7 LED functions	14
3.7.1 Run	14
3.7.2 Status	14
3.7.3 Alarm	14
4 Web interface and selection functions	15
4.1 Homepage	16
4.1.1 Alarm overview	16
4.1.2 Timeline	17
4.1.3 Device overview	18
4.1.4 Topology	19
4.1.5 Network statistics	21
4.2 Alarms	22
4.3 Evaluation	23
4.3.1 Statistics	23
4.3.2 Reports	23
4.4 Configuration	24

4.4.1	System	24
4.4.1.1	General	25
4.4.1.2	Time and language settings	25
4.4.1.3	Network	26
4.4.1.4	Notifications	26
4.4.1.5	Digital Input	27
4.4.1.6	Factory reset	27
4.4.1.7	Import/Export	28
4.4.1.8	Information	28
4.4.2	Monitoring	29
4.4.2.1	Device name	29
4.4.2.2	Device status	30
4.4.2.3	Triggers & alarms	32
4.4.2.4	Automated Report	35
4.4.2.5	Diagnostics	35
4.4.2.6	Control mode	36
4.4.3	Firmware update	36
5	Device parameters	37
5.1	Error telegram	37
5.2	Telegram repetition	37
5.2.1	Max. no. of telegram repetitions per bus cycle	37
5.2.2	Total telegram repetitions	37
5.3	Bus device failure	37
5.4	Bus device restart	37
5.5	Bus device internal diagnostics	38
5.6	Bus device external diagnostics	38
6	Support and contact	39
7	Block diagram	40
8	Technical data	41
8.1	Technical drawing	41

1 General information

Please read this document thoroughly from start to finish before you begin installing the device and putting it into operation.

1.1 Purpose of use

The PROFIBUS-INspektor® NT permanently monitors all data traffic in a PROFIBUS DP, FMS or MPI master system. You will receive a maintenance requirement notification when critical changes that could lead to unplanned system downtimes are detected.

Based on the log analysis, bus cycle times and the following quality parameters are monitored:

- Error telegrams
- Repeat telegrams
- Device failure / restarts
- Device errors (internal/external diagnostics)

Only one PB-INspektor® NT is required for each PROFIBUS master system, irrespective of the number of physical segments. In connection with an active programming cable, APKA II (an optional accessory not included in the scope of supply; art. no. 110040001), this can be seamlessly integrated into the fieldbus at any time without negatively impacting ongoing system operations.

No Profibus addresses or adjustments to the PLC program are required for using the PB-INspektor® NT. It works in an entirely manufacturer-independent way; i.e. the analysis works completely independently of the type of control system and bus devices.

For long-term analysis, the PB-INspektor® NT can remain in the bus system without any time restrictions. The relevant telegram traffic is continuously analysed and evaluated in order to detect deviations from normal conditions and trigger alarms.

1.2 Scope of supply

The scope of supply comprises the following individual parts:

- PROFIBUS-INspektor® NT
- 3-pole plug-in terminal block (power supply)
- 6-pole plug-in terminal block (alarm contacts)
- CD with software for the log analysis and device manual

Please check the contents are complete before putting into operation.

1.3 Safety information

- Never open the housing of the PROFIBUS-INspektor® NT
- Opening the housing immediately voids any warranty.
- If you think the device is defective, send it back to the supplier

2 Device ports and status indicators

2.1 Device ports

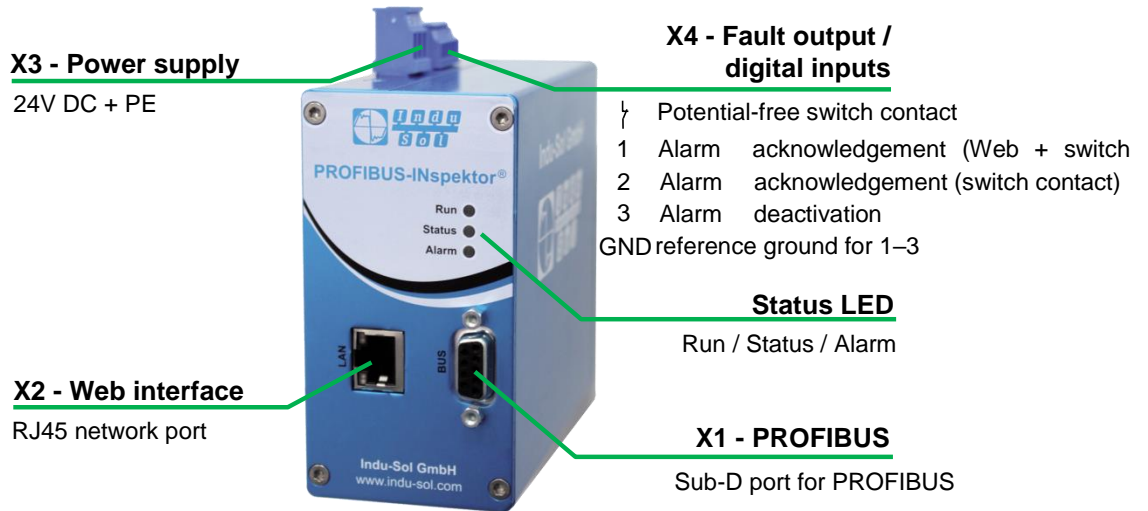

Figure 1: Device ports

2.2 Status LED







LED	Colour		Meaning
Run	Flashing green		Device initialisation
	Green		Measuring mode
Status	Green		PB communication detected
	Flashing orange		Baud rate is being scanned
	Flashing red		Update Mode
Alarm	Green		No unacknowledged alarms
	Red		Alarm

Table 1: Status LED

3 Installation

3.1 Installation instructions

The PROFIBUS-INspektor® NT is installed in the cabinet horizontally on a 35-mm top-hat rail in accordance with DIN EN 60715.



Figure 2: Device installation on top-hat rail

Caution: The following distances must be maintained from other modules for correct installation:

- From left and right: 20 mm
- Above and below: 50 mm

Removal for alternate use of the PB-INspektor® NT in different master systems is illustrated in Figure 3.



Figure 3: Removal

3.2 Voltage supply

Operation requires 24 V of external direct current, which is to be connected to the device via the 3-pole plug-in terminal block supplied in the package. The PE contact should be connected to the local PE system.

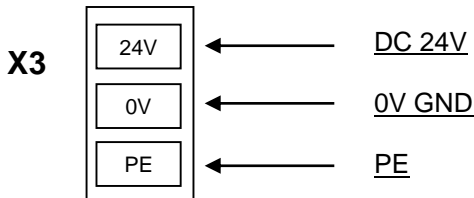

Caution: When connecting, make sure that the polarity is correct.

3.3 Measurement location

The PB-INspektor® NT can essentially be connected to any desired point on a PROFIBUS network. However, the ideal measurement location would preferably be directly on the master / PLC. When this is the case, the bus communication can still be analysed without any problems, even in the event of a line break.

3.4 Connection to the PROFIBUS network

The SUB-D interface for connection to the PROFIBUS network has the following pinout:

Pin No.	Signal	Function
1	-	-
2	-	-
3	RxD/TxD-P	DATA B
4	-	-
5	DGND	Ground
6	VP	+5V power supply
7	-	-
8	RxD/TxD-N	DATA A
9	-	-

Table 2: SUB-D interface pinout

You can connect to the PROFIBUS network in different ways. All three options are presented and described below.

3.4.1 Connection with active programming cable

In connection with the active programming cable APKA II (optional accessory; art. no. 110040001), the PROFIBUS-INspektor® NT can be connected to the PROFIBUS in a very simple way through a stub at any time without compromising ongoing system operations. This can also be performed on a temporary basis if required. A requirement for this is a PROFIBUS connector with an open PG connection socket in the existing system, directly on the PLC if possible. The settings of the terminal resistors on the existing connectors remain unchanged.

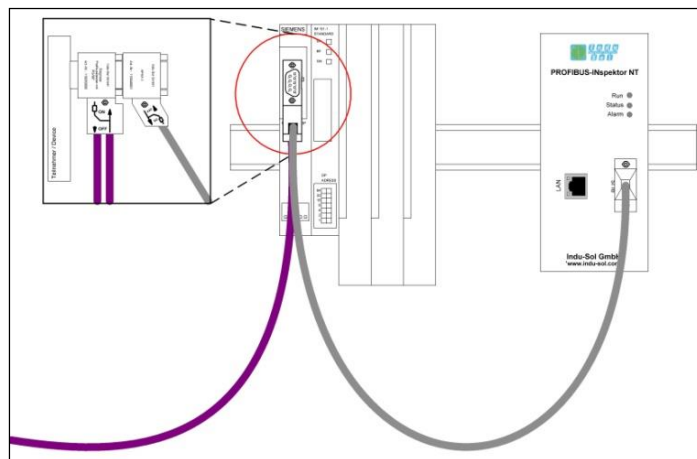

Figure 4: PROFIBUS connection by means of active programming cable

3.4.2 Installation at the end of the segment

The existing segment end of the bus system is extended up to the PB-INspektor® NT, as presented in Figure 5. The open output of the PROFIBUS connector of the last device on the bus is used for this purpose. One piece of PROFIBUS DP cable (from 1.5 MBit/s; at least one metre in length) and a PROFIBUS connector (D-SUB, 9-pole) are required. The terminal resistor usually integrated into the connector on what was the final device is to be switched off and the one on the PB-INspektor® NT is to be switched on in its place (termination: "ON").



Caution: This connection option causes a PROFIBUS network fault and should be performed during system standstill.

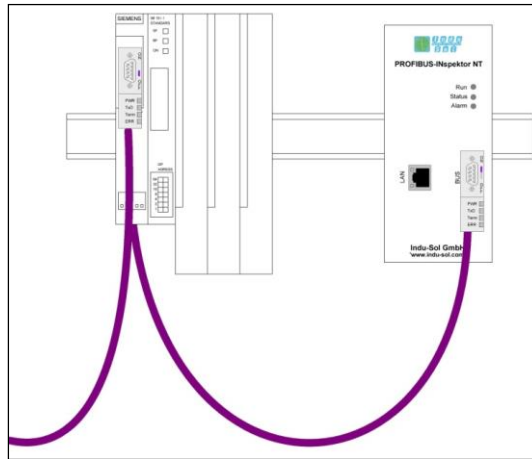

Figure 5: PB-INspektor[®] NT connected as a terminal

3.4.3 Looping into an existing system

The PB-INspektor[®] NT is "looped" into the bus between two existing devices, as can be seen in Figure 6. To do this, the bus is disconnected. One piece of PROFIBUS DP cable (from 1.5 MBit/s; at least one metre in length) and a PROFIBUS connector (D-SUB, 9-pole) are required. The terminal resistor integrated into the connector on the PB-INspektor[®] NT is to be switched off and sits in the "OFF" position, accordingly.



Caution: This connection option causes a PROFIBUS network fault and should be performed during system standstill.

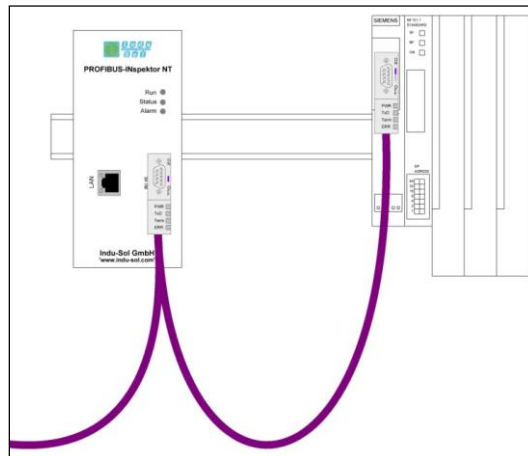

Figure 6: "Looping in" between two devices

3.5 LAN connection

The LAN connection **X2** provides the Ethernet connection to the PB-INspektor® NT. This involves a 1000Base-T RJ45 interface. A standard Ethernet cable is used as a connection cable to a PC/ laptop (not included in the scope of supply).

Both the evaluation of internally recorded data and the parametrisation of the device are possible through this access point.

The PROFIBUS-INspektor® NT is supplied with the following **factory-set** network configuration:

IP address: 192.168.212.212
Subnet mask: 255.255.255.0

A Web-server function is integrated for access to the device and can be opened with an appropriate standard browser (e.g. Microsoft Internet Explorer from version 10 or Mozilla Firefox from version 11; JavaScript must be activated). You can reach the device's user interface by entering the IP address of the PB-INspektor® NT in the browser's command line.



Caution: To display the website correctly, the following ports must be enabled in firewalls, gateways and routers: TCP/80 and TCP/6325.

3.6 Signal inputs and outputs

The 6-pole connector terminal block at the top of the device is assigned as follows:

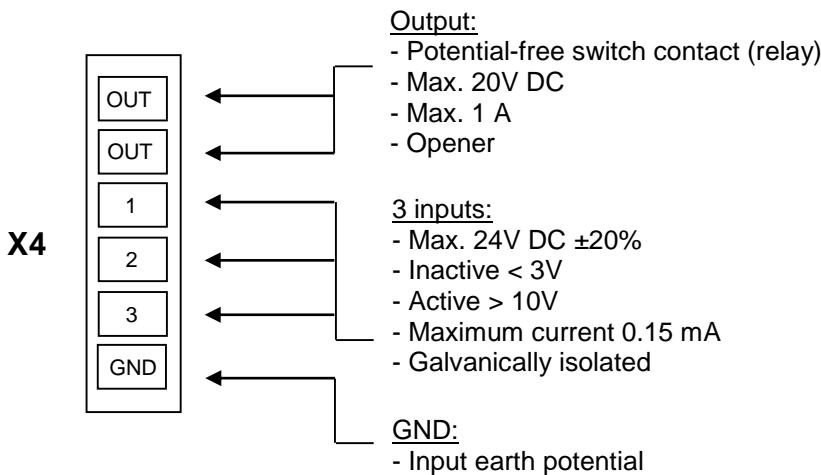

Input 1: Alarm acknowledgement (Web interface + switch contact)

Input 2: Alarm acknowledgement (switch contact)

Input 3: Alarm deactivation

Additional functions can be configured via the Web interface (see point [4.4.1.4. Digital Input](#))

3.7 LED functions

3.7.1 Run

The green Run LED indicates the voltage supply status. This flashes during internal device start-up and lights up permanently in normal operation.

When this LED remains off this is a sign that there is no supply voltage or there is an internal defect or tripped overvoltage protection. In both of these cases the device must be sent in for repair.

3.7.2 Status

The Status LED can signal many conditions using a multi-colour indicator. In this process the following information is presented:

- Green: Bus communication has been detected
- Flashing orange: Looking for bus
- Flashing red: Device fault

3.7.3 Alarm

The Alarm LED lights up red if the PB-INspektor® NT has detected a fault in the PROFIBUS communication and the trigger for the alarm is activated. If no alarm has been triggered, this LED lights up green.

4 Web interface and selection functions

To access the Web interface, and thus the recorded data of the PROFIBUS-INspektor® NT, use an Internet browser and enter the IP address (standard: 192.168.212.212) to open the Web interface.

The following icons are used in the Web interface for a simple overview of the individual statuses of the network and devices:



No faults: PROFIBUS communication is working without any problems.



Warning: A communication fault or a diagnostic message has appeared in the network, or originated from a device, and this fault or message has not yet led to system failure. The sources of these events should be localised and resolved.



Fault: A critical fault has appeared in the network, or originated from a device, and this fault leads to system failure. It is urgently necessary to resolve the fault.



The bus communication in the network has failed or cannot be detected by the INspektor (serious fault in the network) or the device is no longer communicating or is not in the network.



These devices are slaves that actually exist but are not set up in the configuration.

4.1 Homepage

The homepage provides a complete overview of the status of the connected PROFIBUS master system since the start of the PB-INspektor® NT.

If there are no faulty entries here, the system is working stably and there are no urgent actions required.

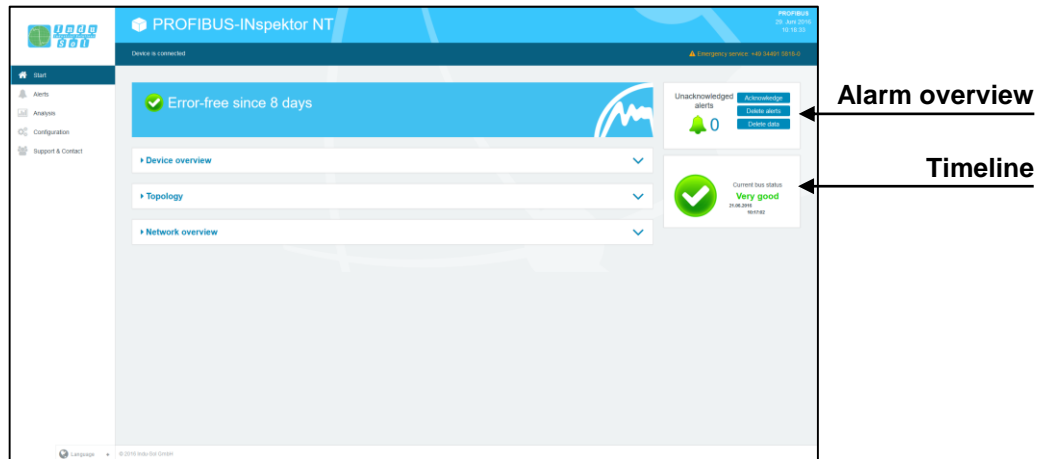

Figure 7: Complete overview

There are additional helpful functions for obtaining more detailed information on the state of the network. These can be accessed via drop-down menus and the two additional windows Alarm Overview and Timeline.

Specifying the time period, with a corresponding display of device information, is possible in the sub-menus of the homepage. The relevant period of evaluation can be selected by switching the time window between 'current', 'last minute' and 'history'. The 'current' setting always displays the device status (live list) at that particular moment, and the 'last minute' option shows the device information over the course of the previous minute. With the 'history' pre-selection, all data is displayed since the beginning of the recording or the last time 'Delete data' was commanded. You can use these different time references to determine whether PROFIBUS faults are occurring occasionally or permanently.

4.1.1 Alarm overview

In the alarm overview the number of unacknowledged alarms are indicated to you. The entries in the alarm list are opened automatically with a mouse click on the alarm bell.

You can also perform the following functions in this window:

- Acknowledge alarms:** Unacknowledged alarms are acknowledged, but the entries stay in the alarm list
- Delete alarms:** Alarm list is deleted
- Delete data:** All previously recorded data is deleted and the network analysis is restarted

4.1.2 Timeline

The timeline offers you a compact visual overview of the state of the network over the course of time. If different network statuses are analysed within the course of the monitoring period, the point in time when the respective status change started is presented as a new node (maximum 50 entries). Detailed information accumulated within this time frame can be opened by selecting one such node. The minimum time period for a status change (new nodes) is one minute.

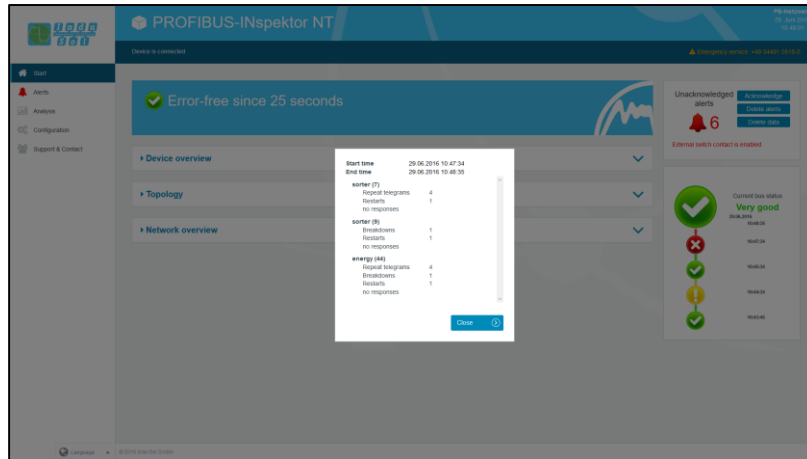

Figure 8: Timeline entry



The individual status changes can be adjusted for each device separately. (See point [4.4.2.2 Device status](#)).

4.1.3 Device overview

In this overview you get a complete overview of all the addresses possible in a PROFIBUS network (0–126). These are presented in colour in the matrix based on the status of the individual devices. A key to the individual statuses is displayed in the top left.

In order to increase the clarity, you can change the display in the upper selection box to “existing only”. The default address-related device description can be exchanged in the second submenu by selecting the relevant evaluation criteria for displaying the amount of events of discovered device parameters (error telegrams, repeat telegrams, diagnostic, etc.).

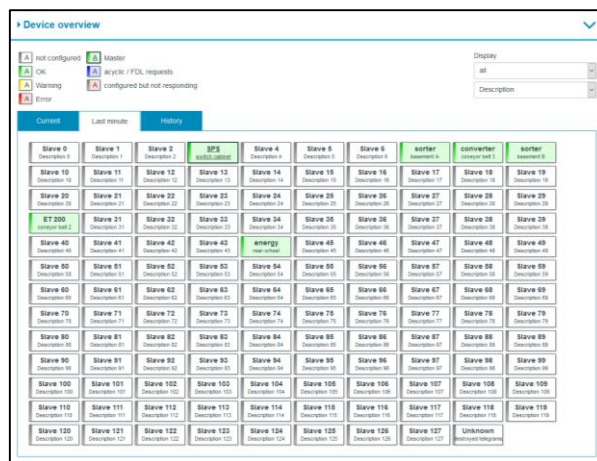

Figure 9: Device overview selection window

For a detailed view of the respective device information, select the relevant device.

Address 44 - energy - rear-wheel		Last minute	History
Status		ok	error
Error telegrams		0	0
Max. repetitions within one cycle		0	4
Repeat telegrams		0	4
Breakdowns		0	1
Restarts		0	1
Diagnosis (internal)		0	0
Diagnosis (external)		0	0
Frames (received)		100 789	807 513
Frames (sent)		100 789	806 899
Last minute	active	incoming IO data 2 Bytes	
History	active	outgoing IO data 2 Bytes	
	Warning		
	Error		
General	cyclic telegrams (data exchange)		
	acyclic telegrams (FDL status)		

Figure 10: Detailed information window (e.g. address 44)



All telegrams that cannot be specifically assigned to a particular device are assigned to the 'unknown' address window. This is the case when the sender address is no longer legible (error telegram), for example.

4.1.4 Topology

For a targeted analysis and effective fault evaluation of a network, a topology with a depiction of the complete, actual wiring sequence of all PROFIBUS devices is a fundamental requirement. That is why the PB-INSpektor® NT provides the option of storing a topology on the Web interface. An automatic scanning of the bus structure cannot be performed.

The saved topology is displayed with the respective device statuses in the overview display. This way you get a quick overview of the current and historical states of your network. You can therefore localise the weak point in the network in the event of a fault and initiate appropriate measures for fault resolution in a targeted manner. You also have the option of opening detailed information on the devices here.

Using the navigation and zoom tools, you can move around the window and adjust the size of the elements.

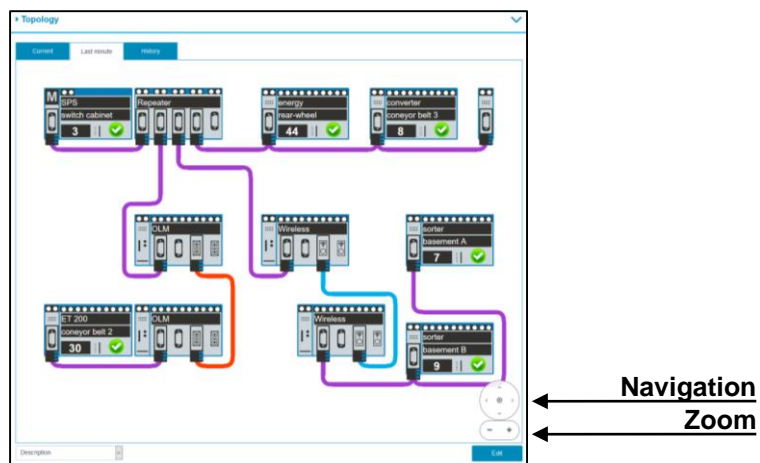









Figure 11: Topology plan display

Editing mode is activated via the 'Edit' button, with which you can create or modify a topology. In this mode the following tools are available to you for this purpose:

-  Device Adds additional devices (Device, Repeater, Diag-Rep, OLM, Wireless, Test point)
-  Copper Adds additional connections (Copper, Optical, Wireless)
-  Adds additional tool boxes (for example switch cabinet)
-  Edits the corresponding device information (ID, name and description)
-  Moving and positioning the selected elements
-  Removes devices, repeaters and connections from the topology
-  Deletes the entire topology

Web interface and selection functions

As a starting point, it is possible to adopt all detected devices from the device overview into the current plan using the 'Add all' button.

For further completion of the topology it is possible to add missing devices or components which are not in possession of an own bus address (repeater, OLM, wireless converters or measuring ports).

Subsequently all modules will be brought in position according to the real wiring sequence. After selection of the appropriate medium (copper, optical, wireless) they can be connected with each other.

Through the selection of the option “move” or “delete” there is the possibility to undertake corrections in your topology also in a later stage. If you select the option “edit” and activate the single devices in the same time you have the possibility to add a plant-specific Identification (for example “utility indicator”). (see also [4.4.2.1 device name](#)).

To save all changes, press the 'Submit' button.

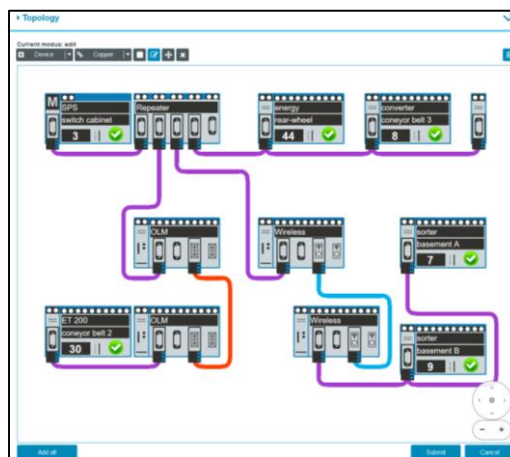

Figure 12: Edit mode

4.1.5 Network statistics

You obtain a complete overview of all the important quality parameters of a PROFIBUS master system through the 'Network statistics' selection window. These form the basis for a network's stability. The individual parameters are explained in more detail in point [5. Device parameters](#).

To make it easier to evaluate the quality parameters, they can be coloured according to predefined acceptance values. (see point [4.4.2.5 Control mode](#))

Network overview		
	Last minute	History
Measurement start time	06/29/2016 11:29:34	06/29/2016 10:43:44
Error telegrams	✓ 0	! 1
Max. repetitions within one cycle	✓ 0	! 4
Repeat telegrams	✓ 0	! 12
Breakdowns	✓ 0	✗ 2
Restarts	✓ 0	✗ 3
Diagnosis (internal)	✓ 0	✓ 0
Diagnosis (external)	✓ 0	✓ 0
Cycle time min avg max (in ms)	0.59 0.60 0.61	0.52 0.60 0.68
Transmitted frames	3.782.317	177.117.873
Uptime	Baud rate	Temperature
00:46:49	12,0 Mbit/s	50 °C

Figure 13: Network statistics overview

4.2 Alarms

This overview represents a list of all alarm entries since the restart or the resetting of alarms through the 'Delete alarms' or 'Delete data' commands. All unacknowledged entries are indicated with the 🚨 icon. The maximum quantity of saved alarms is 2,048. Any additional entries over that overwrite the oldest entries.

An entry is automatically made in the alarm list, including a telegram record (snapshot), when a triggering event occurs. Such an entry will contain all important information, such as the device address, fault event and time. In addition to an entry in the alarm overview, the value for unacknowledged alarms increases by one. The saved snapshots can be downloaded by pressing the disc icon and opened with the PROFIBUS Diagnostics Suite software. (If this software is not included in the scope of delivery, you can download it at <http://www.indu-sol.com/support/downloads/software/>).

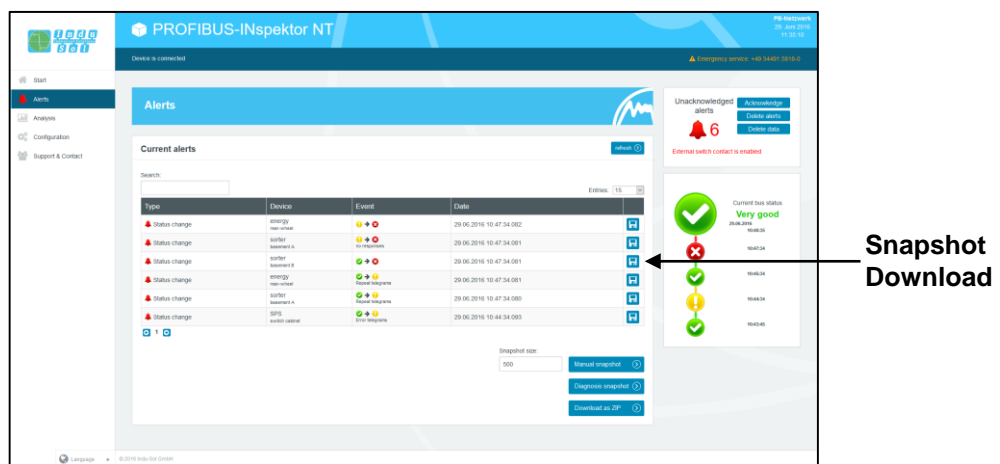

Figure 14: Alarms

The following functions are also available to you in this menu:

- refresh:** Updates the entries in the alarm list
- Manual snapshot:** Records the current telegram traffic, which is also stored as an entry in the alarm list.
- Diagnosis snapshot:** All accumulated diagnostics can be summarised in a snapshot and downloaded with this option
- Download as ZIP:** You can download all snapshots and a currently created log as a ZIP archive through this option.

4.3 Evaluation

The evaluation menu contains the statistics and log function.

4.3.1 Statistics

This sub-menu offers a statistics function for individual PROFIBUS quality parameters through all analysed device addresses. Through this option you can see the address-related accumulation for the selected parameter at a glance.

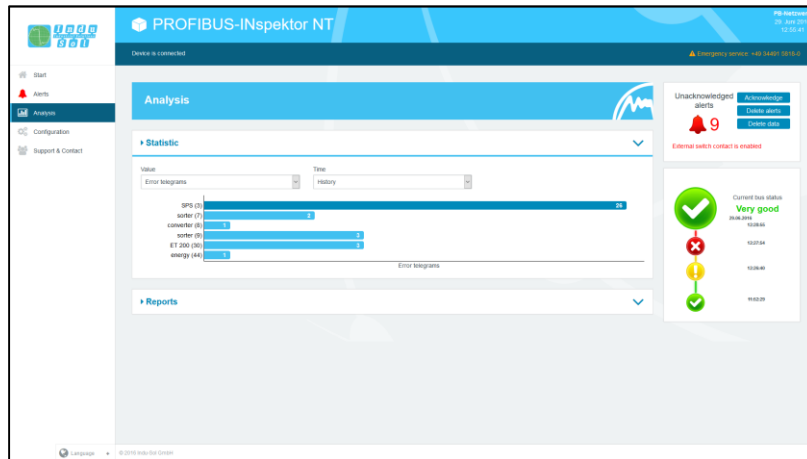

Figure 15: Statistics function

4.3.2 Reports

The log function allows for all information gathered since the beginning of the recording to be documented in a report in summary form. These logs are stored in the log directory and can be exported from here or printed out. The logs can be used for one's own documentation or as an acceptance report.

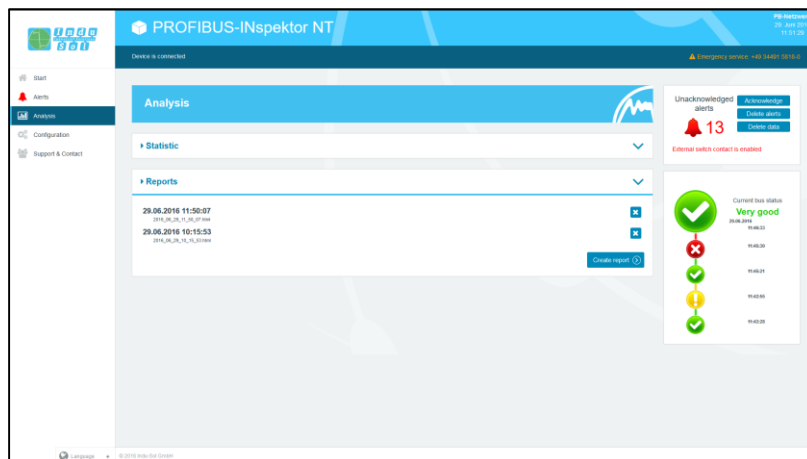

Figure 16: Reports



The 'Print background' function must be activated in the respective browser for the complete display of the topology in the log print.

The log function can also be used for the automatic creation of logs (see section [4.4.2.4 Automatic log](#)).

4.4 Configuration

Within the configuration menu, you can make changes to the general device settings of the PB-INSPEKTOR® NT and adapt the monitoring function specifically to your PROFIBUS network.



All entries are saved in the device by pressing the **'Adopt'** button or reset to the default setting through **'Reset' + 'Adopt'**.

The functions are described individually below.

4.4.1 System

Basic device settings, such as date / time, device name, IP address, etc., are displayed in the system settings and can be changed here. The entries are kept in the event of power failure or device modification.

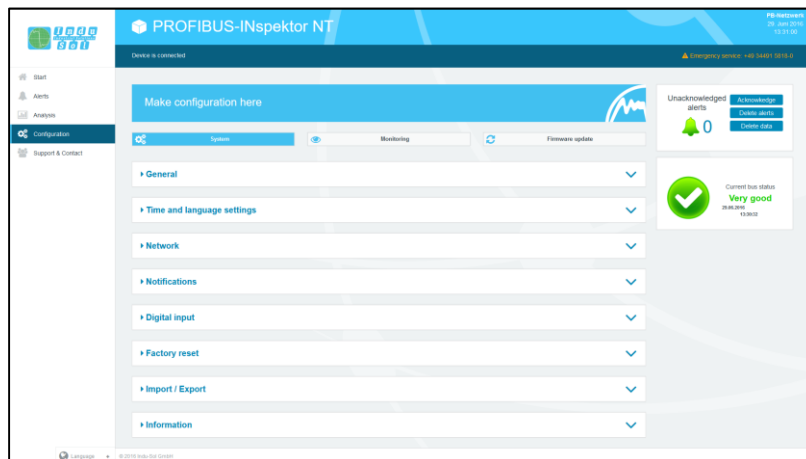

Figure 17: System settings – device overview

4.4.1.1 General

In this sub-menu, entries can be made for device name, installation location, network name and notes that provide a more detailed description of the device and the network to be monitored. In addition to these entries, this menu allows setting up a password for the INspektor®. This password will then be required for all changes made to device and monitoring settings.

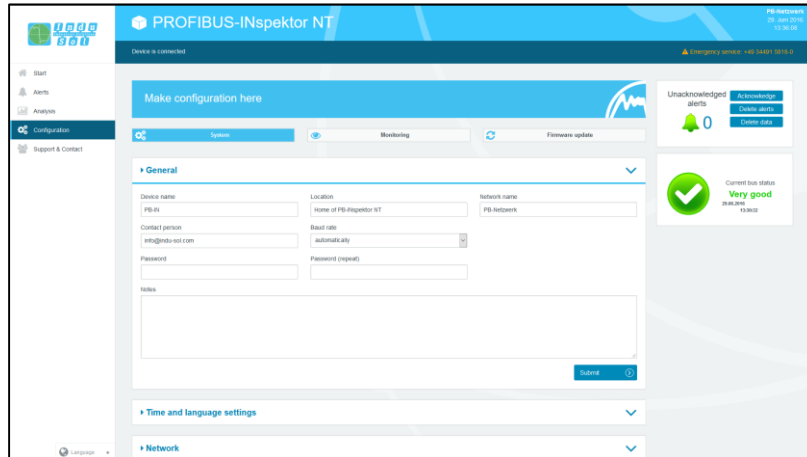

Figure 18: System settings – general

4.4.1.2 Time and language settings

In this menu, settings are made for the system time and for the default language of the PN-INspektor® NT. The system time can either be entered manually, be adopted automatically from local PC system time, or be retrieved from a time server.

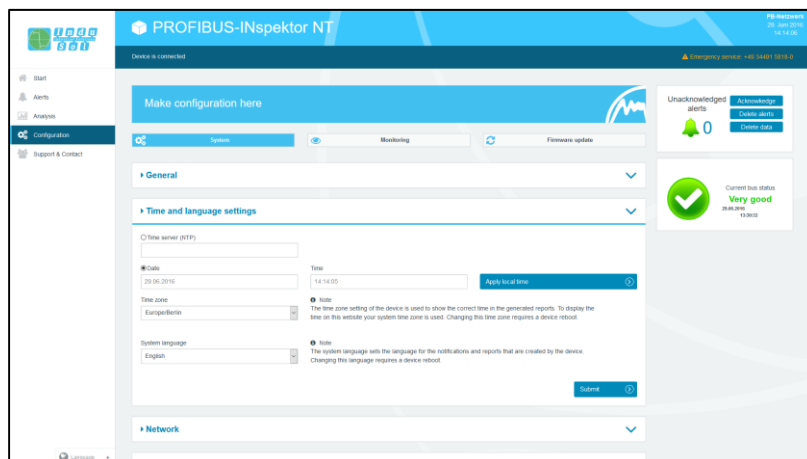

Figure 19: Time and language settings



In order for the time to be displayed correctly in the log, you must always specify the time zone, both if the time is entered manually and if it is retrieved automatically.

4.4.1.3 Network

Under this item the network address settings are defined for the PB-INspektor® NT (e.g. address, subnet mask, gateway). In this process you can decide whether you want to use a fixed address or if the IP address should be obtained automatically (DHCP).

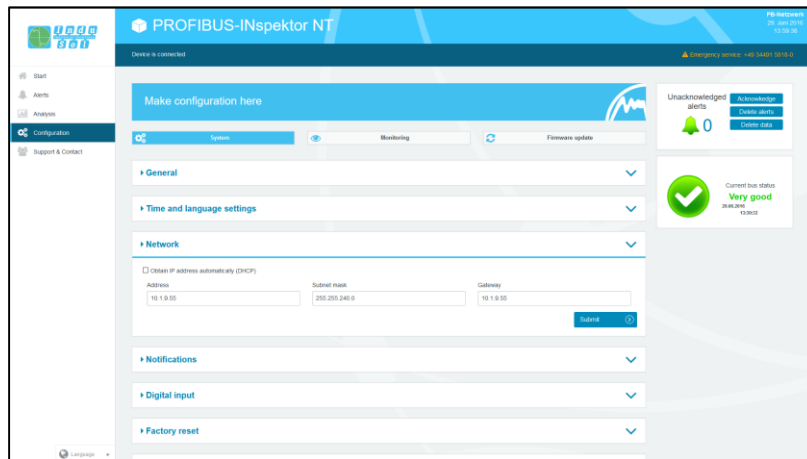

Figure 20: Network settings

4.4.1.4 Notifications

With the notification function it is possible to arrange the sending of an email through the PB-INspektor® NT in the event of an alarm. To do this you require a valid recipient address, the IP address of the email server resp. SNMP trap host and an Ethernet connection between the device and the server.

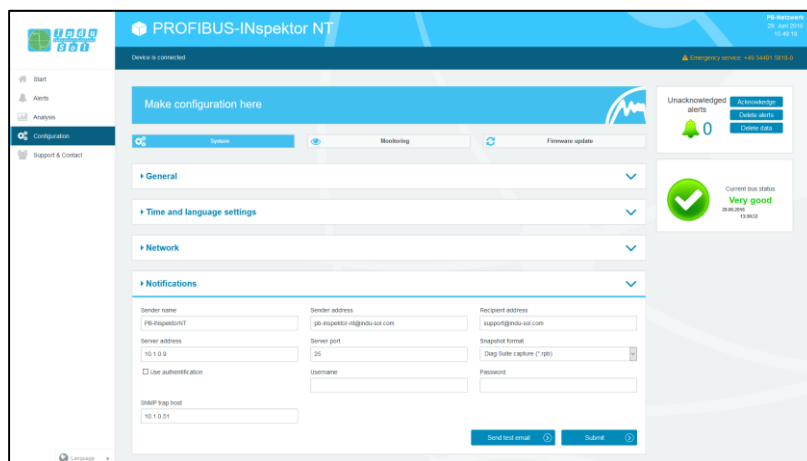

Figure 21: 'Notifications' selection window



For email alerts it is imperative that the "Email" action has been activated for the desired trigger condition (see section [4.4.2.3 Triggers & alarms](#)).

4.4.1.5 Digital Input

For configuration of the digital inputs, you can choose between the following actions under this point. You can enter either a specific or an arbitrary slope change, and multiple actions per input.

- Disable alerts
- Delete data
- Creat report
- Acknowledge alerts
- Reset digital output



Abbildung 22: Digital Input

4.4.1.6 Factory reset

Here you can reset the PN-INspektor[®] NT to default settings. You have the option to retain the network settings, or to reset them as well. After the reset, the device is available again immediately.

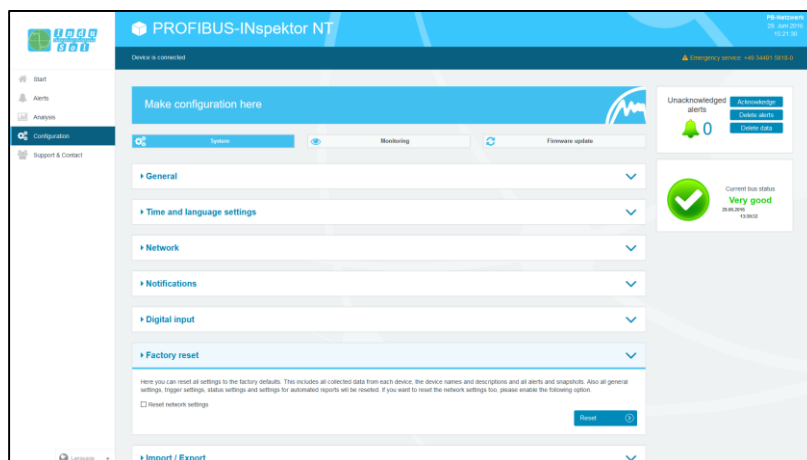

Figure 23: Factory reset



In a reset to default settings, all previously made settings and records are lost.

4.4.1.7 Import/Export

By means of the Import/Export function, all settings that have been made, e.g. general device settings and changes to PROFINET monitoring, can be saved, and loaded again into a PN-INspektor® NT whenever required.

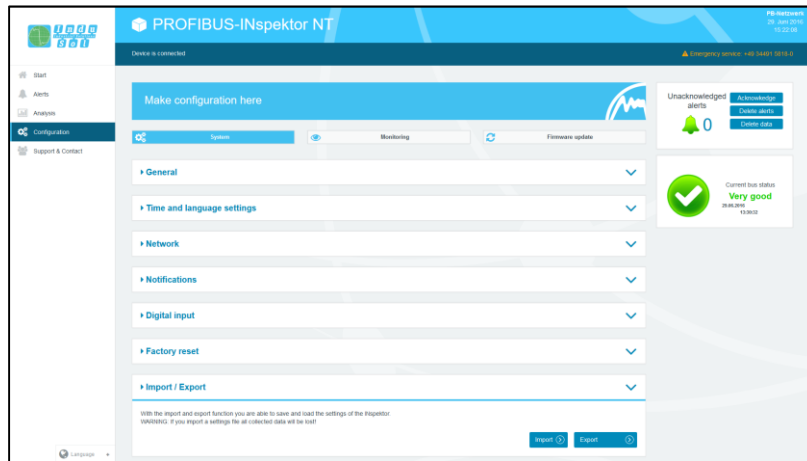

Figure 24: Import/Export

4.4.1.8 Information

Current resource usage and the firmware and hardware versions of the PB-INspektor® NT are displayed in the information overview.

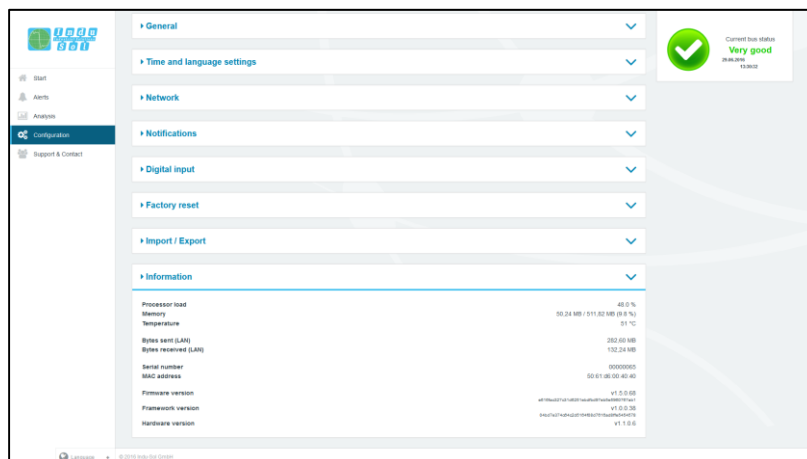

Figure 25: PB-INspektor® NT device information

4.4.2 Monitoring

You can specifically adjust the monitoring function of the PB-INspektor® NT to your network and define customised trigger and alarm thresholds with the specifications in these fields.



Figure 26: Monitoring – complete overview

4.4.2.1 Device name

All device names and their descriptions can be customised under the item 'Device names'. It is therefore possible, for example, to adopt and to save the device model, equipment identifier or installation location from the electrical diagrams. All entries are then visible for example in the device overview (see item [4.1.3](#)) and in the topology (see item [4.1.4](#)).

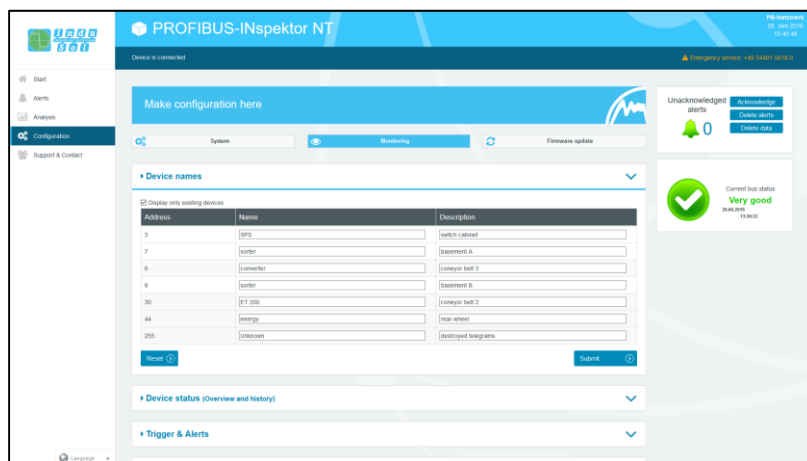





Figure 27: Device names overview

4.4.2.2 Device status

You can make adjustments to the display of device statuses over the entire master system (globally) and to specific devices in this sub-menu. In this process, a device may adopt the following statuses, depending on the fault event and setting:

-  No fault
-  Warning
-  Error

In the default setting, the PB-INspektor® NT is programmed so that diagnostics, error telegrams and repetitions of any device lead to 'Warning' status; and failures and restarts lead to 'Fault' status.

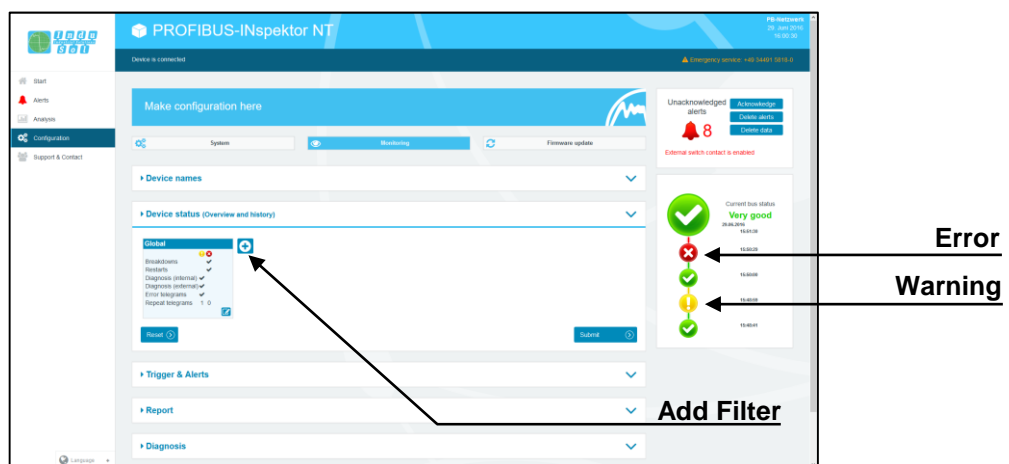

Figure 28: Device status – default setting

By adding and editing additional event fields, the device statuses can be customised. In this process, device-specific settings overwrite global values. This means it is possible to create device-specific settings to hide fault events which are justified in normal system operation.

Example: The system operator must enter a light barrier for a part change. This results in external diagnostics which are irrelevant to bus status evaluation. By deselecting the diagnostics of the devices concerned in PB-INspektor® NT, these stay 'green' in the display.

As can be seen in the figure below, the event 'External diagnostics' was deselected for address 7 in this example, and the status change for device 8 was completely deactivated.

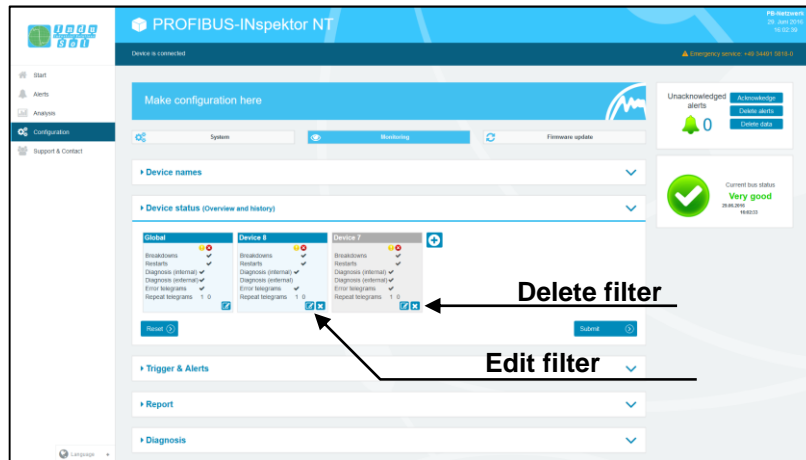

Figure 29: Applying filters

The figure below shows the setting options in the editing window for address 9 as an example.

The tick in the settings window is removed to deactivate the devices.

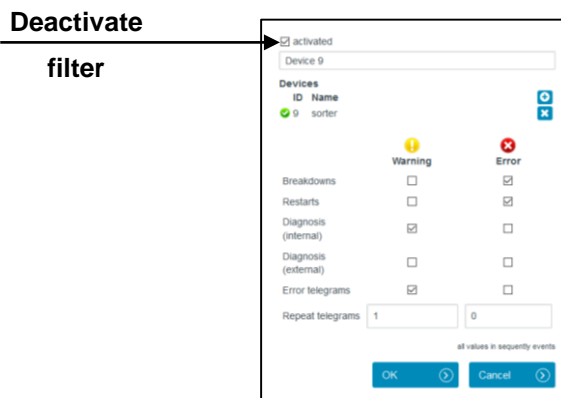

Figure 30: External diagnostics deactivated for address 9

4.4.2.3 Triggers & alarms

For the configuration of alarms and evaluation through switch contact, snapshot and email, the relevant parameters can be set under the item 'Triggers & alarms'.

In the device's default settings, all fault events of any PROFIBUS device automatically lead to an alarm through the alarm LED, activation of the switch contact, creation of a fault record (snapshot) and notification via email and SNMP-trap (if configured).

The number of telegrams before and after an event can be freely selected between 0 and 2500. This means that the size of the snapshot can be freely selected as required.

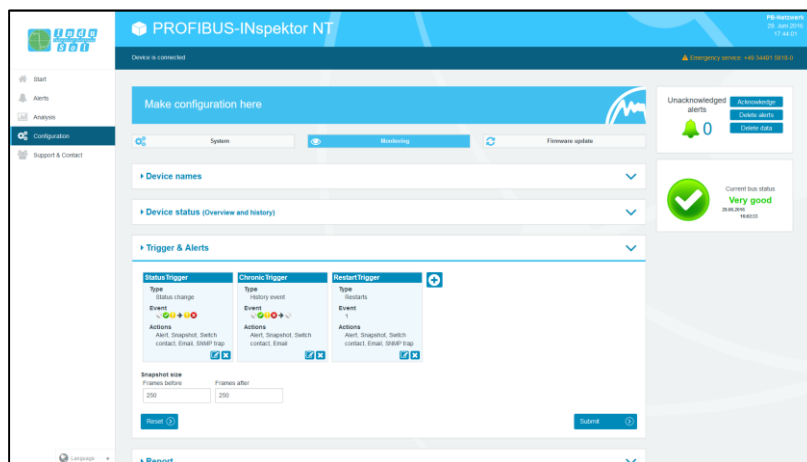

Figure 31: Triggers & alarms – default setting

Through a variable configuration of fault triggers in the form of different trigger types and special device addresses, it is possible to make the relevant adjustments here for a targeted fault search or targeted device monitoring.

The various options for editing individual filters are described in greater detail below.

By selecting the editing mode via the edit icon, the selection menu opens for adjusting the settings.

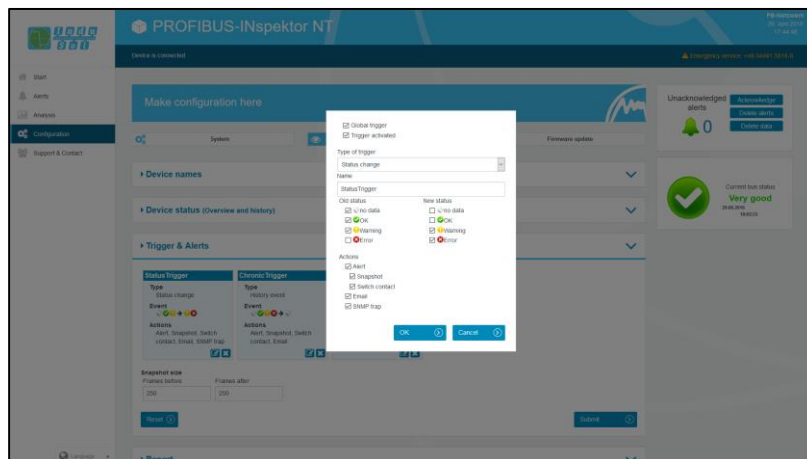

Figure 32: Selection menu for trigger type 'status change'

The menu presented in Figure 33 is available for specifying the trigger type.

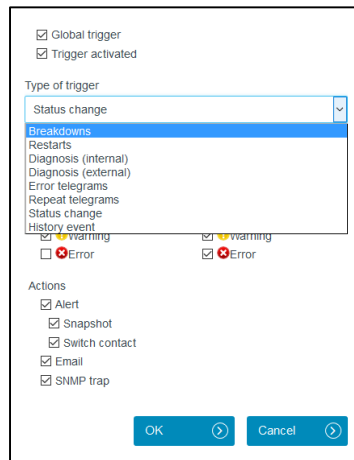

Figure 33: Trigger types

When selecting the functions breakdown, restart, diagnostics (internal), diagnostics (external), error telegram, telegram repetition and status change, you have the option of global monitoring (all devices) or an address-specific selection. By deselecting the item 'Global trigger' the address window is displayed in which you can enter the individual device addresses.

Under the item 'Threshold value' the quantity of **events per bus cycle** is specified that should lead to a trigger tripping.

You can make practical use of this setting in conjunction with telegram repetitions to indicate the first signs of deterioration in communication before device failure occurs.

Example: The telegram repetition rate (retry limit) is set to 3 reps/cycle in the hardware configuration and the threshold value in the PB-INspektor® NT is set to 2 telegram repetitions. If there is now a repetition occasionally in normal operation for process-related reasons, that can be considered perfectly normal. If these repetitions accumulate around 2 successive events due to ageing, an alarm is triggered by the PB-INspektor® NT as an early warning; even though the bus system continues to function without device failure. Thanks to this timely alert, you now have time to react before system failure to get to the bottom of the issue.

The trigger types 'Status change' and 'Timeline event' relate to changes in the entries which have been recorded under the item 'Device status' or in the timeline display respectively.

The measures for when a trigger event occurs are defined in the menu for the item 'Actions'.

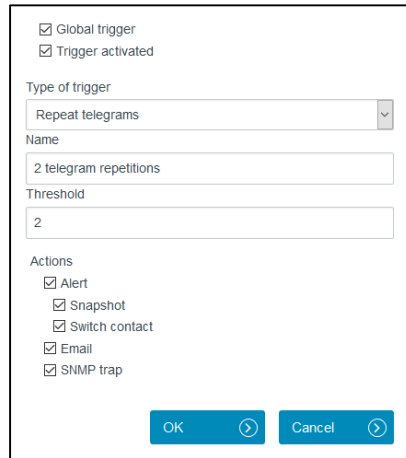

Figure 34: Trigger actions selection

With the settings in the following example (Figure 35), only the failure of device 7 causes a trigger.

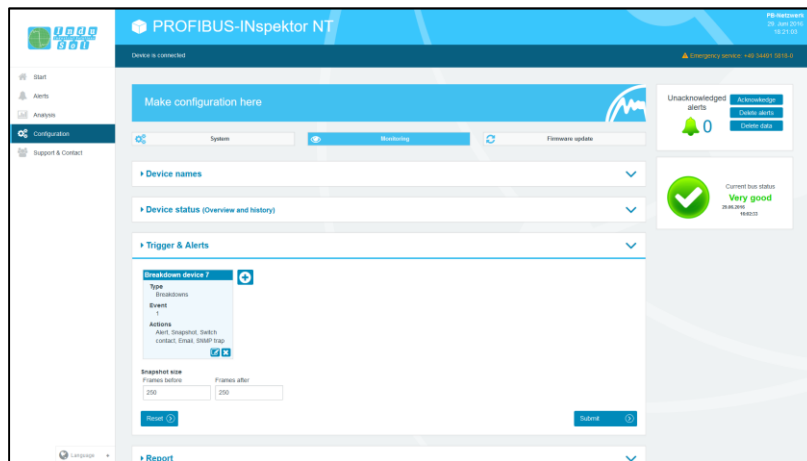

Figure 35: Device 7 failure trigger setting

4.4.2.4 Automated Report

The function 'Automatic log' provides you with the option of documenting the current system status at pre-set time intervals. These logs are then saved in the device regularly and are thus available to you for opening at any time (see item [4.3.2 Report](#)).

For the completion of the documentation, both the customer data and that of the system inspector can be added. Furthermore, the different sections for log creation can be selected or deselected and an individual company logo can be used.

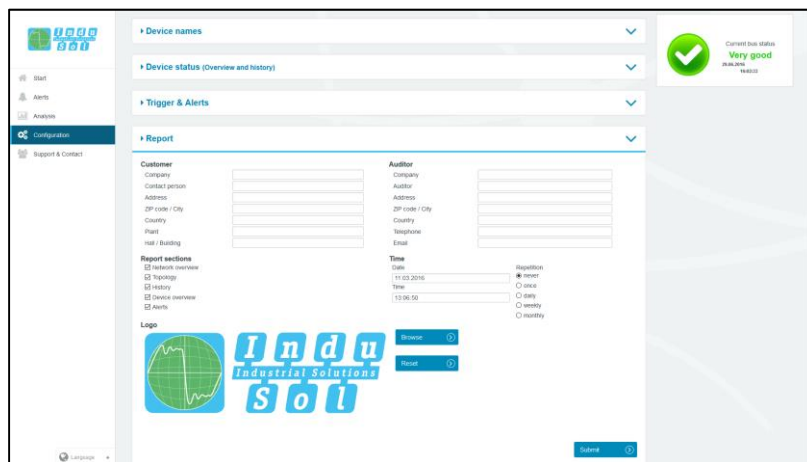

Figure 36: Selection window for automatic report creation

4.4.2.5 Diagnostics

The settings for the content of the 'diagnostics snapshot' are configured in this sub-menu (see item [4.2 Alarms](#)). In the default setting, all diagnostics telegrams of all devices are saved in the 'diagnostics snapshot' for later evaluation. The function can be global or specified for individual devices by adding address-related entries (see Figure 33: the diagnostics for address 7 have been deselected).

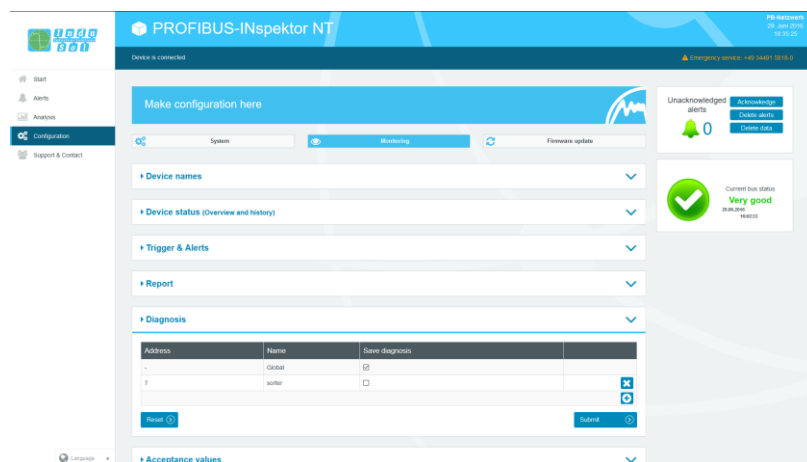

Figure 37: Diagnostics – address 7 deselected

4.4.2.6 Control mode

To allow rapid visual evaluation of the PROFINET network, individual quality parameters can be coloured by entering specific acceptance values. This setting is used both for the website (see point [4.1.3 Network statistic](#)) and for the log.

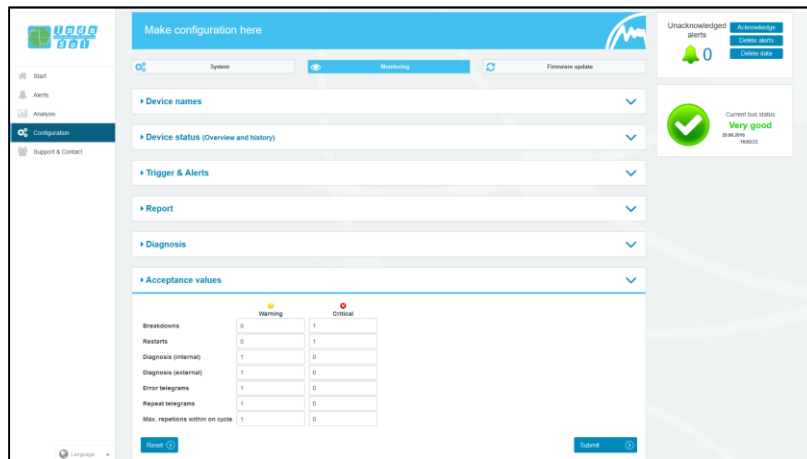

Figure 38: Control mode

4.4.3 Firmware update

You can perform a firmware update for the PB-INspektor® NT using this function, if required. To do this, the new firmware file is selected and uploaded via the 'Search' button. Following successful installation, triggering a restart is required in the device with the "Restart" button.

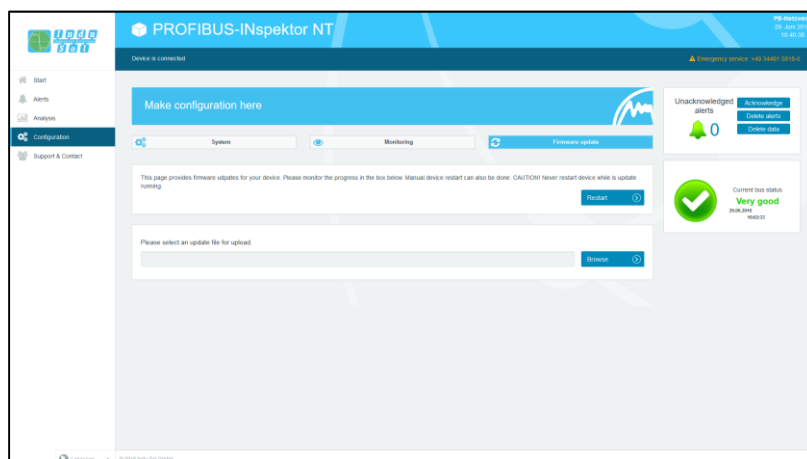

Figure 39: Firmware update

5 Device parameters

5.1 Error telegram

The 'Error telegram' parameter indicates the quantity of faulty or destroyed telegrams. An error telegram is detected through a checksum error or parity error, for example.

5.2 Telegram repetition

If a bus device does not respond after a pre-defined time, it is asked to re-send the data by the master: this is what is referred to as 'telegram repetition'. This also occurs when the master cannot interpret the content of a telegram. The maximum number of telegram repetitions per cycle is set in the master through the 'Retry limit' parameter.

5.2.1 Max. no. of telegram repetitions per bus cycle

With 'Max. no. of telegram repetitions per bus cycle', the maximum number of repeat requests to a bus device per bus cycle is recorded. If a bus device fails, the value displayed equates to the set retry limit.

5.2.2 Total telegram repetitions

With 'Total telegram repetitions', all telegram repetitions occurring within the recording period are counted.

5.3 Bus device failure

The 'Bus device failure' parameter counts all device failures that occur. A bus device failure occurs when the set retry limit (max. number of successive telegram repetitions) is exceeded.

5.4 Bus device restart

The parameter 'Bus device restart' counts all device restarts that occur. A restart of a bus device occurs after a failure or a system start when a bus device has its parameters set by the control system without any faults and then begins the cyclical data exchange.

5.5 Bus device internal diagnostics

Direct bus module faults are described for internal diagnostics.

Examples for internal diagnostics are:

- Short circuit on an internal backplane bus or the I/O modules inside the slave
- Processing of a specific master request without resourcing being available

5.6 Bus device external diagnostics

External events which are not directly associated with the bus or the bus module are detected and reported for external diagnostics.

Examples for external diagnostics are:

- Wire break of an external sensor on an analogue 4–20 mA input
- Switching off the voltage for an expansion module by opening the safety door
- Lack of compressed air at a valve terminal module

6 Support and contact

Should you wish to contact us for any reason or require quick assistance regarding device functions, further information can be accessed from this page.

Manuals are also stored here for support.

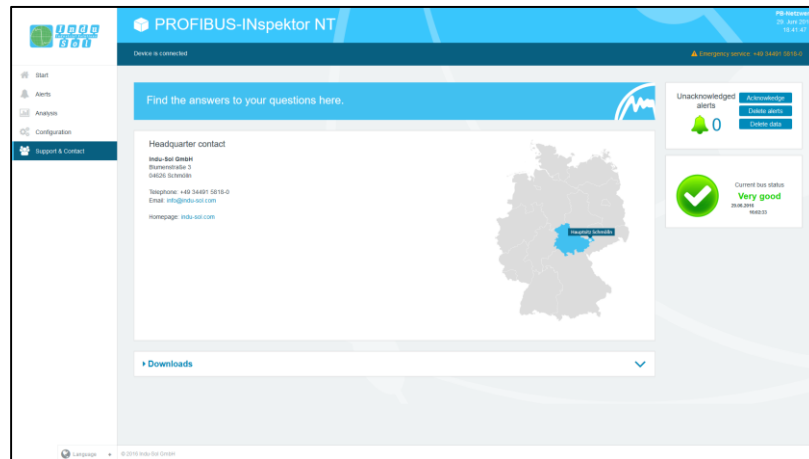

Figure 40: Support and contact

7 Block diagram

The following image is a schematic diagram of the PN-INspektor® NT.

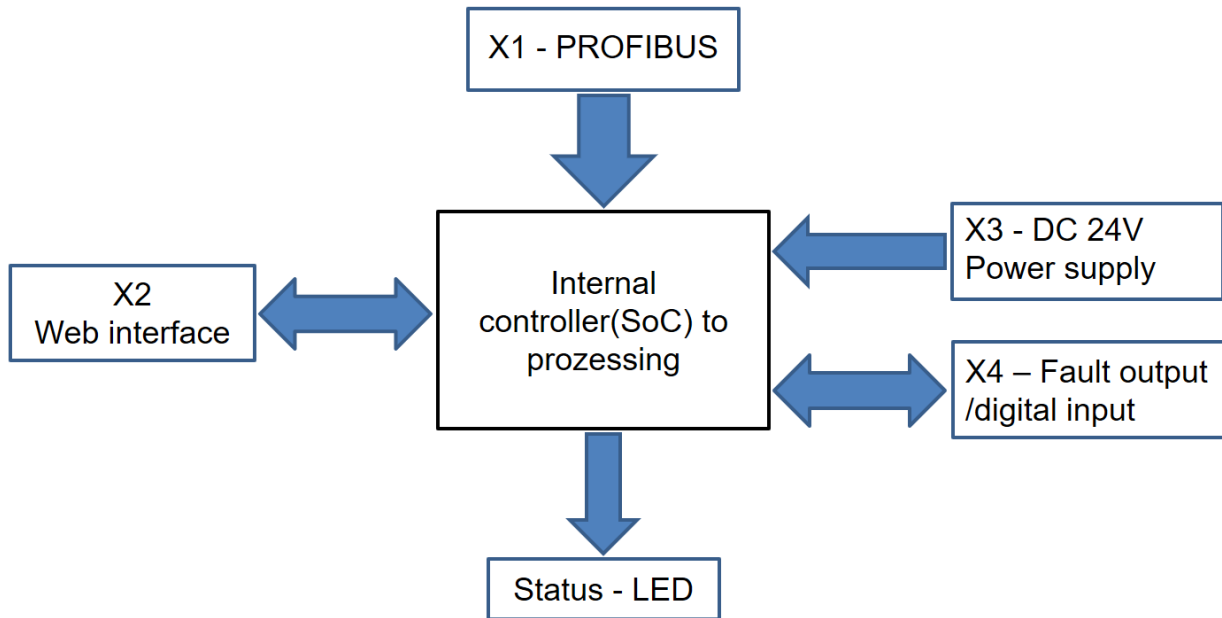

Figure 41: Block diagram

8 Technical data

- Voltage supply: +24V DC
- Tolerance: $\pm 10\%$
- Power consumption: max. 200 mA
- Starting current: max. 200 mA
- Dimensions (W x H x D): 55 x 105 x 124 (in mm)
- Assembly: TS35 DIN top-hat rail (EN 50022)
- Weight: 0.6 kg
- Protection class: IP20
- Operating temperature: +5°C to +55°C
- Storage temperature: -20°C to +70°C
- Relative air humidity: 10%...90%

8.1 Technical drawing

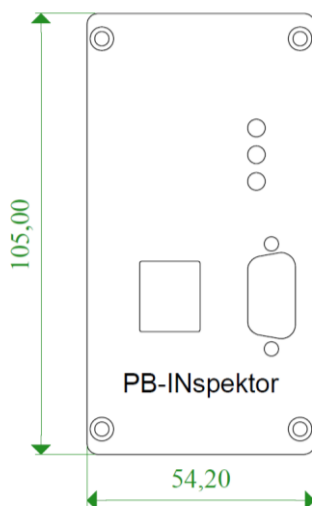

Figure 42: Front view

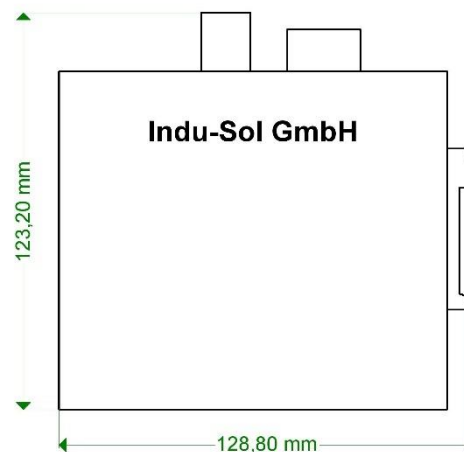

Figure 43: Side view with plugs and top-hat rail mounting

Indu-Sol GmbH
Blumenstrasse 3
04626 Schmoelln

Telephone: +49 (0) 34491 5818-0
Telefax: +49 (0) 34491 5818-99

info@indu-sol.com
www.indu-sol.com

We are certified according to DIN ES ISO 9001:2008