

VIPA SPEED7

OPL_SP7 | Operation list | Manual

HB00 | OPL_SP7 | Operation list | en | 18-30

SPEED7 Operation list



VIPA GmbH
Ohmstr. 4
91074 Herzogenaurach
Telephone: +49 9132 744-0
Fax: +49 9132 744-1864
Email: info@vipa.de
Internet: www.vipa.com

Table of contents

1	General	13
	1.1 Copyright © VIPA GmbH	13
	1.2 About this manual.....	14
2	Important notes	15
	2.1 General.....	15
	2.2 Internally used blocks.....	15
	2.3 No optimized block access.....	16
	2.4 Declaration types.....	16
3	IL operations	17
	3.1 Overview.....	17
	3.2 Abbreviations.....	21
	3.3 Comparison of syntax languages.....	24
	3.4 Differences between SPEED7 and 300V programming.....	25
	3.5 Registers.....	27
	3.6 Addressing examples.....	28
	3.7 Math instructions.....	30
	3.8 Block instructions.....	35
	3.9 Program display and Null operation instructions.....	36
	3.10 Edge-triggered instructions.....	37
	3.11 Load instructions.....	38
	3.12 Shift instructions.....	41
	3.13 Setting/resetting bit addresses.....	43
	3.14 Jump instructions.....	44
	3.15 Transfer instructions.....	47
	3.16 Data type conversion instructions.....	51
	3.17 Comparison instructions.....	53
	3.18 Combination instructions (Bit).....	55
	3.19 Combination instructions (Word).....	63
	3.20 Timer instructions.....	64
	3.21 Counter instructions.....	65
4	Block parameters	66
	4.1 HW identifier - HW_ID.....	66
	4.2 General and Specific Error Information RET_VAL.....	66
5	Include VIPA library	69
	5.1 Integration into Siemens SIMATIC Manager.....	69
	5.2 Integration into Siemens TIA Portal.....	70
6	Organization Blocks	71
	6.1 Overview.....	71
	6.2 Main.....	71
	6.2.1 OB1 - Main - Program Cycle.....	71
	6.3 Startup.....	72
	6.3.1 OB 100, OB 102 - Complete/Cold Restart - Startup.....	72
	6.4 Communication Interrupts.....	74
	6.4.1 OB 55 - DP: Status Alarm - Status Interrupt.....	74
	6.4.2 OB 56 - DP: Update Alarm - Update Interrupt.....	75
	6.4.3 OB 57 - DP: Manufacture Alarm - Manufacturer Specific Interrupt.....	76
	6.5 Time delay Interrupts.....	77

6.5.1	OB 20, OB 21 - DEL_INTx - Time-delay Interrupt.....	77
6.6	Time of day Interrupts.....	78
6.6.1	OB 10, OB 11 - TOD_INTx - Time-of-day Interrupt.....	78
6.7	Cyclic Interrupts.....	80
6.7.1	OB 28, 29, 32, 33, 34, 35 - CYC_INTx - Cyclic Interrupt.....	80
6.8	Hardware Interrupts.....	82
6.8.1	OB 40, OB 41 - HW_INTx - Hardware Interrupt.....	82
6.9	Asynchronous error Interrupts.....	84
6.9.1	OB 80 - CYCL_FLT - Time Error.....	84
6.9.2	OB 81 - PS_FLT - Power Supply Error.....	86
6.9.3	OB 82 - I/O_FLT1 - Diagnostic Interrupt.....	87
6.9.4	OB 83 - I/O_FLT2 - Insert / Remove Module.....	89
6.9.5	OB 85 - OBNL_FLT - Priority Class Error.....	92
6.9.6	OB 86 - RACK_FLT - Slave Failure / Restart.....	96
6.10	Synchronous Interrupts.....	98
6.10.1	OB 121 - PROG_ERR - Programming Error.....	98
6.10.2	OB 122 - MOD_ERR - Periphery access Error.....	100
7	Building Control.....	102
7.1	Overview.....	102
7.1.1	Call example - instance DB.....	102
7.1.2	Call example - multi instances DB.....	102
7.2	Room.....	103
7.2.1	FB 45 - LAMP - Controlling lamp / socket.....	103
7.2.2	FB 46 - BLIND - Controlling blind.....	104
7.2.3	FB 47 - DSTRIKE - Electric door opener	106
7.3	Access Control.....	107
7.3.1	FB 48 - ACONTROL - Access control.....	107
7.3.2	UDT 3 - ACLREC - Data structure for FB 48.....	108
7.3.3	UDT 4 - ACL - Data structure for FB 48.....	109
7.3.4	FB 49 - KEYPAD - Keyboard.....	109
7.3.5	FB 50 - KEYPAD2 - Keyboard.....	111
8	Network Communication.....	114
8.1	Open Communication.....	114
8.1.1	Connection-oriented protocols.....	114
8.1.2	Connection-less protocols.....	114
8.1.3	FB 63 - TSEND - Sending data - TCP native and ISO on TCP.....	115
8.1.4	FB 64 - TRCV - Receiving Data - TCP native and ISO on TCP.....	118
8.1.5	FB 65 - TCON - Establishing a connection.....	122
8.1.6	UDT 65 - TCON_PAR Data structure for FB 65.....	124
8.1.7	FB 66 - TDISCON - Terminating a connection.....	129
8.1.8	FB 67 - TUSEND - Sending data - UDP.....	131
8.1.9	FB 68 - TURCV - Receiving data - UDP.....	133
8.1.10	UDT 66 - TADDR_PAR Data structure.....	136
8.2	Ethernet Communication.....	137
8.2.1	Communication - FC 5...6 for CP 343.....	137
8.2.2	FC 5 - AG_SEND - Send to CP 343.....	139
8.2.3	FC 6 - AG_RECV - Receive from CP 343.....	142
8.2.4	FC 10 - AG_CNTRL - Control CP 343.....	144
8.2.5	FC 62 - C_CNTR - Querying the Connection Status.....	151

8.2.6	FB/SFB 8 - FB 55 - Overview.....	153
8.2.7	FB/SFB 8 - USEND - Uncoordinated data transmission.....	154
8.2.8	FB/SFB 9 - URCV - Uncoordinated data reception.....	155
8.2.9	FB/SFB 12 - BSEND - Sending data in blocks.....	158
8.2.10	FB/SFB 13 - BRCV - Receiving data in blocks.....	161
8.2.11	FB/SFB 14 - GET - Remote CPU read.....	163
8.2.12	FB/SFB 15 - PUT - Remote CPU write.....	165
8.2.13	FB 55 - IP_CONF - Progr. Communication Connections.....	167
9	Modbus Communication.....	183
9.1	TCP.....	183
9.1.1	FB 70 - TCP_MB_CLIENT - Modbus/TCP client.....	183
9.1.2	FB 71 - TCP_MB_SERVER - Modbus/TCP server.....	186
9.2	RTU.....	190
9.2.1	FB 72 - RTU_MB_MASTER - Modbus RTU master.....	190
9.2.2	FB 73 - RTU_MB_SLAVE - Modbus RTU slave.....	193
9.3	FKT Codes.....	197
10	Serial Communication.....	203
10.1	Serial communication.....	203
10.1.1	SFC 207 - SER_CTRL - Modem functionality PtP.....	203
10.1.2	FC/SFC 216 - SER_CFG - Parametrization PtP.....	204
10.1.3	FC/SFC 217 - SER_SND - Send to PtP.....	208
10.1.4	FC/SFC 218 - SER_RCV - Receive from PtP.....	213
10.1.5	FB 1 - RECEIVE_ASCII - Receiving with defined length from PtP.....	215
10.1.6	FB 7 - P_RCV_RK - Receive from CP 341.....	216
10.1.7	FB 8 - P_SND_RK - Send to CP 341.....	217
10.2	CP040.....	219
10.2.1	Overview.....	219
10.2.2	FB 60 - SEND - Send to System SLIO CP 040.....	220
10.2.3	FB 61 - RECEIVE - Receive from System SLIO CP 040.....	223
10.2.4	FB 65 - CP040_COM - Communication SLIO CP 040.....	225
10.3	CP240.....	230
10.3.1	FC 0 - SEND_ASCII_STX_3964 - Send to CP 240.....	230
10.3.2	FC 1 - RECEIVE_ASCII_STX_3964 - Receive from CP 240.....	232
10.3.3	FC 8 - STEUERBIT - Modem functionality CP 240.....	233
10.3.4	FC 9 - SYNCHRON_RESET - Synchronization CPU and CP 240.....	234
10.3.5	FC 11 - ASCII_FRAGMENT - Receive fragmented from CP 240.....	236
11	EtherCAT Communication.....	238
11.1	SDO Communication.....	238
11.1.1	FB 52 - SDO_READ - Read access to Object Dictionary Area.....	238
11.1.2	FB 53 - SDO_WRITE - Write access to Object Dictionary Area.....	242
12	Device Specific.....	246
12.1	Frequency Measurement.....	246
12.1.1	FC 300 ... 303 - Frequency measurement SLIO consistent.....	246
12.1.2	FC 300 - FM_SET_CONTROL - Control frequency measurement consistent.....	246
12.1.3	FC 301 - FM_GET_PERIOD - Calculate period duration consistent.....	248
12.1.4	FC 302 - FM_GET_FREQUENCY - Calculate frequency consistent.....	251
12.1.5	FC 303 - FM_GET_SPEED - Calculate rotational speed consistent.....	253
12.1.6	FC 310 ... 313 - Frequency measurement SLIO.....	256

12.1.7	FC 310 - FM_CONTROL - Control frequency measurement.....	256
12.1.8	FC 311 - FM_CALC_PERIOD - Calculate period duration	258
12.1.9	FC 312 - FM_CALC_FREQUENCY - Calculate frequency.....	260
12.1.10	FC 313 - FM_CALC_SPEED - Calculate rotational speed.....	262
12.2	Energy Measurement.....	264
12.2.1	Overview.....	264
12.2.2	FB 325 - EM_COM_R1 - Communication with 031-1PAxx.....	267
12.2.3	UDT 325 - EM_DATA_R1 - Data structure for FB 325.....	268
12.3	Motion Modules.....	271
12.3.1	Overview.....	271
12.3.2	FB 320 - ACYC_RW - Acyclic access to the System SLIO motion module.....	273
12.3.3	FB 321 - ACYC_DS - Acyclic parametrization System SLIO motion module.....	276
12.3.4	UDT 321 - ACYC_OBJECT-DATA - Data structure for FB 321.....	279
12.4	RAM to WLD - "WLD".....	280
12.4.1	FB 240 - RAM_to_s7prog.wld - RAM to s7prog.wld.....	280
12.4.2	FB 241 - RAM_to_autoload.wld - RAM to autoload.wld.....	280
12.5	Onboard I/O System 100V.....	281
12.5.1	SFC 223 - PWM - Pulse duration modulation.....	281
12.5.2	SFC 224 - HSC - High-speed-Counter.....	283
12.5.3	SFC 225 - HF_PWM - HF pulse duration modulation.....	285
13	Motion control - <i>Simple Motion Control Library</i>	287
13.1	Overview.....	287
13.2	Usage <i>Sigma-5/7</i> EtherCAT.....	288
13.2.1	Usage <i>Sigma-5</i> EtherCAT.....	288
13.2.2	Usage <i>Sigma-7S</i> EtherCAT.....	324
13.2.3	Usage <i>Sigma-7W</i> EtherCAT.....	362
13.3	Usage <i>Sigma-5/7</i> Pulse Train.....	405
13.3.1	Overview.....	405
13.3.2	Set the parameters on the drive.....	405
13.3.3	Wiring.....	406
13.3.4	Usage in <i>VIPA SPEED7 Studio</i>	408
13.3.5	Usage in Siemens SIMATIC Manager.....	412
13.3.6	Usage in Siemens TIA Portal.....	417
13.3.7	Drive specific block.....	423
13.4	Usage inverter drive via PWM.....	430
13.4.1	Overview.....	430
13.4.2	Set the parameters on the inverter drive.....	430
13.4.3	Wiring.....	432
13.4.4	Usage in <i>VIPA SPEED7 Studio</i>	433
13.4.5	Usage in Siemens SIMATIC Manager.....	438
13.4.6	Usage in Siemens TIA Portal.....	443
13.4.7	Drive specific block.....	449
13.5	Usage inverter drive via Modbus RTU.....	452
13.5.1	Overview.....	452
13.5.2	Set the parameters on the inverter drive.....	452
13.5.3	Wiring.....	454
13.5.4	Usage in <i>VIPA SPEED7 Studio</i>	457
13.5.5	Usage in Siemens SIMATIC Manager.....	471

13.5.6	Usage in Siemens TIA Portal.....	486
13.5.7	Drive specific blocks.....	504
13.6	Usage inverter drive via EtherCAT.....	511
13.6.1	Overview.....	511
13.6.2	Set the parameters on the inverter drive.....	512
13.6.3	Wiring.....	513
13.6.4	Usage in VIPA <i>SPEED7 Studio</i>	514
13.6.5	Usage in Siemens SIMATIC Manager.....	527
13.6.6	Drive specific blocks.....	541
13.7	Blocks for axis control.....	542
13.7.1	Overview.....	542
13.7.2	Simple motion tasks.....	544
13.7.3	Complex motion tasks - PLCopen blocks.....	548
13.8	Controlling the drive via HMI.....	613
13.8.1	Overview.....	613
13.8.2	Create a new project.....	614
13.8.3	Modify the project in Movicon.....	619
13.8.4	Commissioning.....	629
13.9	States and behavior of the outputs.....	633
13.9.1	States.....	633
13.9.2	Replacement behavior of motion jobs.....	634
13.9.3	Behavior of the inputs and outputs.....	636
13.10	ErrorID - Additional error information.....	637
14	Integrated Standard.....	645
14.1	System Functions.....	645
14.1.1	SFC 0 - SET_CLK - Set system clock.....	645
14.1.2	SFC 1 - READ_CLK - Read system clock	645
14.1.3	SFC 2 ... 4 - Run-time meter	646
14.1.4	SFC 2 - SET_RTM - Set run-time meter.....	646
14.1.5	SFC 3 - CTRL_RTM - Control run-time meter.....	647
14.1.6	SFC 4 - READ_RTM - Read run-time meter.....	647
14.1.7	SFC 5 - GADR_LGC - Logical address of a channel.....	648
14.1.8	SFC 6 - RD_SINFO - Read start information.....	650
14.1.9	SFC 7 - DP_PRAL - Triggering a hardware interrupt on the DP master.....	652
14.1.10	SFC 12 - D_ACT_DP - DP-Activating and Deactivating of DP slaves..	653
14.1.11	SFC 13 - DPNRM_DG - Read diagnostic data of a DP slave.....	657
14.1.12	SFC 14 - DPRD_DAT - Read consistent data.....	659
14.1.13	SFC 15 - DPWR_DAT - Write consistent data.....	660
14.1.14	SFC 17 - ALARM_SQ and SFC 18 - ALARM_S.....	661
14.1.15	SFC 19 - ALARM_SC - Acknowledgement state last Alarm.....	663
14.1.16	SFC 20 - BLKMOV - Block move.....	664
14.1.17	SFC 21 - FILL - Fill a field.....	666
14.1.18	SFC 22 - CREAT_DB - Create a data block.....	667
14.1.19	SFC 23 - DEL_DB - Deleting a data block.....	669
14.1.20	SFC 24 - TEST_DB - Test data block.....	670
14.1.21	SFC 25 - COMPRESS - Compressing the User Memory.....	670
14.1.22	SFC 28 ... SFC 31 - Time-of-day interrupt.....	671
14.1.23	SFC 32 - SRT_DINT - Start time-delay interrupt.....	674
14.1.24	SFC 33 - CAN_DINT - Cancel time-delay interrupt.....	675

14.1.25	SFC 34 - QRY_DINT - Query time-delay interrupt.....	675
14.1.26	SFC 36 - MSK_FLT - Mask synchronous errors.....	676
14.1.27	SFC 37 - DMSK_FLT - Unmask synchronous errors.....	677
14.1.28	SFC 38 - READ_ERR - Read error register.....	678
14.1.29	SFC 39 - DIS_IRT - Disabling interrupts.....	678
14.1.30	SFC 40 - EN_IRT - Enabling interrupts.....	680
14.1.31	SFC 41 - DIS_AIRT - Delaying interrupts.....	681
14.1.32	SFC 42 - EN_AIRT - Enabling delayed interrupts.....	681
14.1.33	SFC 43 - RE_TRIGR - Retrigger the watchdog.....	682
14.1.34	SFC 44 - REPL_VAL - Replace value to ACCU1.....	682
14.1.35	SFC 46 - STP - STOP the CPU.....	682
14.1.36	SFC 47 - WAIT - Delay the application program.....	683
14.1.37	SFC 49 - LGC_GADR - Read the slot address.....	683
14.1.38	SFC 50 - RD_LGADR - Read all logical addresses of a module.....	684
14.1.39	SFC 51 - RDSYSST - Read system status list SSL.....	685
14.1.40	SFC 52 - WR_USMSG - Write user entry into diagnostic buffer.....	687
14.1.41	FC/SFC 53 - uS_Tick - Time measurement.....	689
14.1.42	SFC 54 - RD_DPARM - Read predefined parameter.....	690
14.1.43	SFC 55 - WR_PARM - Write dynamic parameter.....	692
14.1.44	SFC 56 - WR_DPARM - Write default parameter.....	694
14.1.45	SFC 57 - PARM_MOD - Parameterize module.....	696
14.1.46	SFC 58 - WR_REC - Write record.....	698
14.1.47	SFC 59 - RD_REC - Read record.....	700
14.1.48	SFC 64 - TIME_TCK - Read system time tick.....	702
14.1.49	SFC 65 - X_SEND - Send data.....	703
14.1.50	SFC 66 - X_RCV - Receive data.....	705
14.1.51	SFC 67 - X_GET - Read data.....	708
14.1.52	SFC 68 - X_PUT - Write data.....	711
14.1.53	SFC 69 - X_ABORT - Disconnect.....	714
14.1.54	SFC 70 - GEO_LOG - Determining the Start Address of a Module.....	716
14.1.55	SFC 71 - LOG_GEO - Determining the slot belonging to a logical address.....	717
14.1.56	SFC 81 - UBLKMOV - Copy data area without gaps.....	720
14.1.57	SFC 101 - RTM - Handling Runtime meters.....	721
14.1.58	SFC 102 - RD_DPARA - Reading Predefined Parameters.....	722
14.1.59	SFC 105 - READ_SI - Reading Dynamic System Resources.....	723
14.1.60	SFC 106 - DEL_SI - Reading Dynamic System Resources.....	726
14.1.61	SFC 107 - ALARM_DQ and SFC 108 - ALARM_D.....	727
14.2	System Function Blocks.....	729
14.2.1	SFB 0 - CTU - Up-counter.....	729
14.2.2	SFB 1 - CTD - Down-counter.....	730
14.2.3	SFB 2 - CTUD - Up-Down counter.....	731
14.2.4	SFB 3 - TP - Create pulse.....	733
14.2.5	SFB 4 - TON - Create turn-on delay.....	734
14.2.6	SFB 5 - TOF - Create turn-off delay.....	735
14.2.7	FB/SFB 12 - BSEND - Sending data in blocks.....	737
14.2.8	FB/SFB 13 - BRCV - Receiving data in blocks.....	740
14.2.9	FB/SFB 14 - GET - Remote CPU read.....	742
14.2.10	FB/SFB 15 - PUT - Remote CPU write.....	744
14.2.11	SFB 31 - NOTIFY_8P - Messages without acknowledge display (8x)...	746

14.2.12	SFB 32 - DRUM - Realize a step-by-step switch.....	748
14.2.13	SFB 33 - ALARM - Messages with acknowledgement display.....	752
14.2.14	SFB 34 - ALARM_8 - Messages without associated values (8x).....	754
14.2.15	SFB 35 - ALARM_8P - Messages with associated values (8x).....	756
14.2.16	SFB 36 - NOTIFY - Messages without acknowledgement display.....	759
14.2.17	SFB 47 - COUNT - Counter controlling.....	760
14.2.18	SFB 48 - FREQUENC - Frequency measurement.....	765
14.2.19	SFB 49 - PULSE - Pulse width modulation.....	767
14.2.20	SFB 52 - RDREC - Reading record set.....	775
14.2.21	SFB 53 - WRREC - Writing record set.....	776
14.2.22	SFB 54 - RALRM - Receiving an interrupt from a periphery module.....	777
15	Standard.....	795
15.1	Converting.....	795
15.1.1	FB 80 - LEAD_LAG - Lead/Lag Algorithm.....	795
15.1.2	FC 93 - SEG - Seven Segment Decoder.....	796
15.1.3	FC 94 - ATH - ASCII to Hex.....	797
15.1.4	FC 95 - HTA - Hex to ASCII.....	797
15.1.5	FC 96 - ENCO - Encode Binary Position.....	798
15.1.6	FC 97 - DECO - Decode Binary Position.....	798
15.1.7	FC 98 - BCDCPL - Tens Complement.....	799
15.1.8	FC 99 - BITSUM - Sum Number of Bits.....	799
15.1.9	FC 105 - SCALE - Scaling Values.....	800
15.1.10	FC 106 - UNSCALE - Unscaling Values.....	801
15.1.11	FC 108 - RLG_AA1 - Issue an Analog Value.....	802
15.1.12	FC 109 - RLG_AA2 - Write Analog Value 2.....	802
15.1.13	FC 110 - PER_ET1 - Read/Write Ext. Per. 1.....	803
15.1.14	FC 111 - PER_ET2 - Read/Write Ext. Per. 2.....	804
15.2	IEC.....	805
15.2.1	Date and time as complex data types.....	805
15.2.2	FC 1 - AD_DT_TM - Add duration to instant of time.....	805
15.2.3	FC 2 - CONCAT - Concatenate two STRING variables.....	805
15.2.4	FC 3 - D_TOD_DT - Combine DATE and TIME_OF_DAY.....	806
15.2.5	FC 4 - DELETE - Delete in a STRING variable.....	806
15.2.6	FC 5 - DI_STRNG - Convert DINT to STRING.....	807
15.2.7	FC 6 - DT_DATE - Extract DATE from DT.....	807
15.2.8	FC 7 - DT_DAY - Extract day of the week from DT.....	807
15.2.9	FC 8 - DT_TOD - Extract TIME_OF_DAY from DT.....	808
15.2.10	FC 9 - EQ_DT - Compare DT for equality.....	808
15.2.11	FC 10 - EQ_STRNG - Compare STRING for equal.....	808
15.2.12	FC 11 - FIND - Find in a STRING variable.....	809
15.2.13	FC 12 - GE_DT - Compare DT for greater than or equal.....	809
15.2.14	FC 13 - GE_STRNG - Compare STRING for greater than or equal.....	809
15.2.15	FC 14 - GT_DT - Compare DT for greater than.....	810
15.2.16	FC 15 - GT_STRNG - Compare STRING for greater than.....	810
15.2.17	FC 16 - I_STRNG - Convert INT to STRING.....	811
15.2.18	FC 17 - INSERT - Insert in a STRING variable.....	811
15.2.19	FC 18 - LE_DT - Compare DT for smaller than or equal.....	811
15.2.20	FC 19 - LE_STRNG - Compare STRING for smaller then or equal.....	812
15.2.21	FC 20 - LEFT - Left part of a STRING variable.....	812

15.2.22	FC 21 - LEN - Length of a STRING variable.....	813
15.2.23	FC 22 - LIMIT.....	813
15.2.24	FC 23 - LT_DT - Compare DT for smaller than.....	813
15.2.25	FC 24 - LT_STRNG - Compare STRING for smaller.....	814
15.2.26	FC 25 - MAX - Select maximum.....	814
15.2.27	FC 26 - MID - Middle part of a STRING variable.....	815
15.2.28	FC 27 - MIN - Select minimum.....	815
15.2.29	FC 28 - NE_DT - Compare DT for unequal.....	816
15.2.30	FC 29 - NE_STRNG - Compare STRING for unequal.....	816
15.2.31	FC 30 - R_STRNG - Convert REAL to STRING.....	817
15.2.32	FC 31 - REPLACE - Replace in a STRING variable.....	817
15.2.33	FC 32 - RIGHT - Right part of a STRING variable.....	818
15.2.34	FC 33 - S5TI_TIM - Convert S5TIME to TIME.....	818
15.2.35	FC 34 - SB_DT_DT - Subtract two instants of time.....	819
15.2.36	FC 35 - SB_DT_TM - Subtract a duration from a time.....	819
15.2.37	FC 36 - SEL - Binary selection.....	819
15.2.38	FC 37 - STRNG_DI - Convert STRING to DINT.....	820
15.2.39	FC 38 - STRNG_I - Convert STRING to INT.....	820
15.2.40	FC 39 - STRNG_R - Convert STRING to REAL.....	821
15.2.41	FC 40 - TIM_S5TI - Convert TIME to S5TIME.....	821
15.3	IO.....	821
15.3.1	FB 20 - GETIO - PROFIBUS/PROFINET read all Inputs.....	821
15.3.2	FB 21 - SETIO - PROFIBUS/PROFINET write all Outputs.....	822
15.3.3	FB 22 - GETIO_PART - PROFIBUS/PROFINET read a part of the Inputs.....	822
15.3.4	FB 23 - SETIO_PART - PROFIBUS/PROFINET write a part of the Out- puts.....	824
15.4	S5 Converting.....	825
15.4.1	FC 112 - Sine(x) - Sine.....	825
15.4.2	FC 113 - Cosine(x) - Cosine.....	826
15.4.3	FC 114 - Tangent(x) - Tangent.....	827
15.4.4	FC 115 - Cotangent(x) - Cotangent.....	827
15.4.5	FC 116 - Arc Sine(x) - Arcussine.....	828
15.4.6	FC 117 - Arc Cosine(x) - Arcuscosine.....	829
15.4.7	FC 118 - Arc Tangent(x) - Arcustangent.....	830
15.4.8	FC 119 - Arc Cotangent(x) - Arcuscotangent.....	830
15.4.9	FC 120 - Naperian Logarithm $\ln(x)$ - Naperian Logarithm.....	831
15.4.10	FC 121 - Decimal Logarithm $\lg(x)$ - Decimal Logarithm.....	832
15.4.11	FC 122 - Gen. Logarithm to Base b - General Logarithm $\log(x)$ to base b.....	832
15.4.12	FC 123 - E to Power n - E high n.....	833
15.4.13	FC 124 - 10 to Power n - 10 high n.....	834
15.4.14	FC 125 - ACCU 2 to Power ACCU 1 - ACCU 2 high ACCU 1.....	834
15.5	PID Control.....	835
15.5.1	FB 41 - CONT_C - Continuous control.....	835
15.5.2	FB 42 - CONT_S - Step Control.....	841
15.5.3	FB 43 - PULSGEN - Pulse generation.....	846
15.5.4	FB 58 - TCONT_CP - Continuous Temperature Control.....	854
15.5.5	FB 59 - TCONT_S - Temperature Step Control.....	871
15.6	Time Functions.....	878

15.6.1	UDT 60 - WS_RULES - Rule DB.....	878
15.6.2	FC 61 - BT_LT - Convert base timer to local time.....	879
15.6.3	FC 62 - LT_BT - Convert local time to base time.....	880
15.6.4	FC 63 - S_LTINT - Set time interrupt in local time.....	881
16	System Blocks.....	883
16.1	Fetch/Write Communication.....	883
16.1.1	SFC 228 - RW_KACHEL - Page frame direct access.....	883
16.1.2	SFC 230 ... 238 - Page frame communication.....	885
16.1.3	SFC 230 - SEND - Send to page frame.....	897
16.1.4	SFC 231 - RECEIVE - Receive from page frame.....	898
16.1.5	SFC 232 - FETCH - Fetch from page frame.....	899
16.1.6	SFC 233 - CONTROL - Control page frame.....	900
16.1.7	SFC 234 - RESET - Reset page frame.....	901
16.1.8	SFC 235 - SYNCHRON - Synchronization page frame.....	902
16.1.9	SFC 236 - SEND_ALL - Send all to page frame.....	903
16.1.10	SFC 237 - RECEIVE_ALL - Receive all from page frame.....	904
16.1.11	SFC 238 - CTRL1 - Control1 page frame.....	905
16.2	MMC Functions standard CPUs.....	906
16.2.1	SFC 220 ... 222 - MMC Access.....	906
16.2.2	SFC 220 - MMC_CR_F - create or open MMC file.....	906
16.2.3	SFC 221 - MMC_RD_F - read from MMC file.....	908
16.2.4	SFC 222 - MMC_WR_F - write to MMC file.....	909
16.3	File Functions SPEED7 CPUs.....	910
16.3.1	FC/SFC 195 and FC/SFC 208...215 - Memory card access.....	910
16.3.2	FC/SFC 195 - FILE_ATT - Change file attributes.....	911
16.3.3	FC/SFC 208 - FILE_OPN - Open file.....	912
16.3.4	FC/SFC 209 - FILE_CRE - Create file.....	913
16.3.5	FC/SFC 210 - FILE_CLO - Close file.....	914
16.3.6	FC/SFC 211 - FILE_RD - Read file.....	915
16.3.7	FC/SFC 212 - FILE_WR - Write file.....	916
16.3.8	FC/SFC 213 - FILE_SEK - Position pointer.....	918
16.3.9	FC/SFC 214 - FILE_REN - Rename file.....	919
16.3.10	FC/SFC 215 - FILE_DEL - Delete file.....	920
16.4	System Functions.....	921
16.4.1	SFC 75 - SET_ADDR - Set PROFIBUS MAC address.....	921
16.4.2	FC/SFC 193 - AI_OSZI - Oscilloscope-/FIFO function.....	922
16.4.3	FC/SFC 194 - DP_EXCH - Data exchange with CP342S.....	926
16.4.4	FC/SFC 219 - CAN_TLGR - CANopen communication	927
16.4.5	FC/SFC 254 - RW_SBUS - IBS communication.....	929
16.5	System Function Blocks.....	931
16.5.1	SFB 7 - TIMEMESS - Time measurement.....	931
17	SSL System status list.....	932
17.1	Overview SSL.....	932
17.2	Overview - SSL partial lists.....	933
17.3	Module Identification - SSL-ID: xy11h.....	934
17.4	CPU characteristics - SSL-ID: xy12h.....	937
17.5	User memory areas - SSL-ID: xy13h.....	939
17.6	System areas - SSL-ID: xy14h.....	940
17.7	Block types - SSL-ID: xy15h.....	942

17.8	Status of all LEDs - SSL-ID: xy19h.....	944
17.9	Identification of the component - SSL-ID: xy1Ch.....	949
17.10	Interrupt status - SSL-ID: xy22h.....	952
17.11	Communication status data - SSL-ID: xy32h.....	957
17.12	Ethernet details of the module - SSL-ID xy37h.....	963
17.13	TCON Connection - SSL-ID: xy3Ah.....	966
17.14	WebVisu diagnostic information - SSL-ID: xy3Eh.....	969
17.15	Status of the LEDs - SSL-ID: xy74h.....	972
17.16	Status information CPU - SSL-ID: xy91h.....	977
17.17	Stations status information (DPM) - SSL-ID: xy92h.....	980
17.18	Stations status information (DPM, PROFINET-IO, EtherCAT) - SSL-ID: xy94h.....	982
17.19	Status information PROFINET/EtherCAT/PB DP - SSL-ID: xy96h.....	984
17.20	Diagnostic buffer of the CPU/CP - SSL-ID: xyA0h.....	986
17.21	Module diagnostic information - SSL-ID: 00B1h.....	988
17.22	Module diagnostic information via physical address - SSL-ID: 00B2h.....	990
17.23	Module diagnostic information via logical address - SSL-ID: 00B3h.....	991
17.24	Diagnostic data of a DP slave - SSL-ID: 00B4h.....	992
17.25	Information EtherCAT master/slave - SSL-ID: xyE0h.....	993
17.26	EtherCAT bus system - SSL-ID: xyE1h.....	995
17.27	Statistics information to OBs - SSL-ID: xyFAh.....	996
17.28	VSC features - SSL-ID: xyFCh.....	1000
18	Index.....	1002

1 General

1.1 Copyright © VIPA GmbH

All Rights Reserved

This document contains proprietary information of VIPA and is not to be disclosed or used except in accordance with applicable agreements.

This material is protected by the copyright laws. It may not be reproduced, distributed, or altered in any fashion by any entity (either internal or external to VIPA), except in accordance with applicable agreements, contracts or licensing, without the express written consent of VIPA and the business management owner of the material.

For permission to reproduce or distribute, please contact: VIPA, Gesellschaft für Visualisierung und Prozessautomatisierung mbH Ohmstraße 4, D-91074 Herzogenaurach, Germany

Tel.: +49 9132 744 -0

Fax.: +49 9132 744-1864

E-Mail: info@vipa.de

<http://www.vipa.com>



Every effort has been made to ensure that the information contained in this document was complete and accurate at the time of publishing. Nevertheless, the authors retain the right to modify the information.

This customer document describes all the hardware units and functions known at the present time. Descriptions may be included for units which are not present at the customer site. The exact scope of delivery is described in the respective purchase contract.

CE Conformity Declaration

Hereby, VIPA GmbH declares that the products and systems are in compliance with the essential requirements and other relevant provisions. Conformity is indicated by the CE marking affixed to the product.

Conformity Information

For more information regarding CE marking and Declaration of Conformity (DoC), please contact your local VIPA customer service organization.

Trademarks

VIPA, SLIO, System 100V, System 200V, System 300V, System 300S, System 400V, System 500S and Commander Compact are registered trademarks of VIPA Gesellschaft für Visualisierung und Prozessautomatisierung mbH.

SPEED7 is a registered trademark of profichip GmbH.

SIMATIC, STEP, SINEC, TIA Portal, S7-300, S7-400 and S7-1500 are registered trademarks of Siemens AG.

Microsoft and Windows are registered trademarks of Microsoft Inc., USA.

Portable Document Format (PDF) and Postscript are registered trademarks of Adobe Systems, Inc.

All other trademarks, logos and service or product marks specified herein are owned by their respective companies.

Information product support	<p>Contact your local VIPA Customer Service Organization representative if you wish to report errors or questions regarding the contents of this document. If you are unable to locate a customer service centre, contact VIPA as follows:</p> <p>VIPA GmbH, Ohmstraße 4, 91074 Herzogenaurach, Germany</p> <p>Telefax: +49 9132 744-1204</p> <p>E-Mail: documentation@vipa.de</p>
Technical support	<p>Contact your local VIPA Customer Service Organization representative if you encounter problems with the product or have questions regarding the product. If you are unable to locate a customer service centre, contact VIPA as follows:</p> <p>VIPA GmbH, Ohmstraße 4, 91074 Herzogenaurach, Germany</p> <p>Tel.: +49 9132 744-1150 (Hotline)</p> <p>E-Mail: support@vipa.de</p>

1.2 About this manual

Target audience	The manual is targeted at users who have a background in automation technology.
Structure of the manual	The manual consists of chapters. Every chapter provides a self-contained description of a specific topic.
Guide to the document	<p>The following guides are available in the manual:</p> <ul style="list-style-type: none">■ An overall table of contents at the beginning of the manual■ References with page numbers
Availability	<p>The manual is available in:</p> <ul style="list-style-type: none">■ printed form, on paper■ in electronic form as PDF-file (Adobe Acrobat Reader)
Icons Headings	Important passages in the text are highlighted by following icons and headings:

**DANGER!**

Immediate or likely danger. Personal injury is possible.

**CAUTION!**

Damages to property is likely if these warnings are not heeded.



Supplementary information and useful tips.

2 Important notes

2.1 General



In the following, you will find important notes, which must always be observed when using the blocks.

2.2 Internally used blocks



CAUTION!

The following blocks are used internally and must not be overwritten! The direct call of an internal block leads to errors in the corresponding instance DB! Please always use the corresponding function for the call.

FC/SFC	Designation	Description
FC/SFC 192	CP_S_R	is used internally for FB 7 and FB 8
FC/SFC 196	AG_CNTRL	is used internally for FC 10
FC/SFC 200	AG_GET	is used internally for FB/SFB 14
FC/SFC 201	AG_PUT	is used internally for FB/SFB 15
FC/SFC 202	AG_BSEND	is used internally for FB/SFB 12
FC/SFC 203	AG_BRCV	is used internally for FB/SFB 13
FC/SFC 204	IP_CONF	is used internally for FB 55 IP_CONF
FC/SFC 205	AG_SEND	is used internally for FC 5 AG_SEND
FC/SFC 206	AG_RECV	is used internally for FC 6 AG_RECV
FC/SFC 253	IBS_ACCESS	is used internally for SPEED bus INTERBUS masters
SFB 238	EC_RWOD	is used internally for EtherCAT Communication
SFB 239	FUNC	is used internally for FB 240, FB 241

2.3 No optimized block access



Please note that the blocks do not support optimized block access for use in S7-1500 CPUs from Siemens! When using instance and data blocks, the optimized block access must be deactivated!

Set block access

1. ➤ Open in the Siemens TIA Portal *Project navigation* the 'Program blocks'.
2. ➤ Select the block for which you want to change the block access and select 'Context menu → Properties'.
⇒ The "Properties" dialog of the block opens.
3. ➤ Select 'Attributes'.
4. ➤ Deactivate the parameter 'Optimized block access'.
5. ➤ Confirm with [OK].

More information can be found in the manual of the Siemens TIA Portal.

2.4 Declaration types

Please note that the spellings of the declaration types in Siemens STEP7 and TIA Portal differ. This documentation uses the notation for Siemens STEP7. A comparison of the spellings can be found in the following table.

Siemens TIA Portal	Siemens STEP7
Input	IN
Output	OUT
InOut	IN_OUT
Static	STAT
Temp	TEMP

3 IL operations

3.1 Overview

The following canter lists the available commands of the SPEED7 CPUs from VIPA. The instruction list intends to give you an overview over the commands and their syntax. The commands are sorted by topics in alphabetical order. For the parameters are integrated in the instruction list, there is no extra parameter list.

Instruction	Description	Page
)	Combination instructions (Bit)	↪ 55
+	Math instructions	↪ 30
+AR1	Math instructions	↪ 30
+AR2	Math instructions	↪ 30
+I	Math instructions	↪ 30
+D	Math instructions	↪ 30
+R	Math instructions	↪ 30
-D	Math instructions	↪ 30
-I	Math instructions	↪ 30
-R	Math instructions	↪ 30
*D	Math instructions	↪ 30
*I	Math instructions	↪ 30
*R	Math instructions	↪ 30
/D	Math instructions	↪ 30
/I	Math instructions	↪ 30
/R	Math instructions	↪ 30
==D	Comparison instructions	↪ 53
==I	Comparison instructions	↪ 53
==R	Comparison instructions	↪ 53
<=D	Comparison instructions	↪ 53
<=I	Comparison instructions	↪ 53
<=R	Comparison instructions	↪ 53
<D	Comparison instructions	↪ 53
<I	Comparison instructions	↪ 53
<R	Comparison instructions	↪ 53
<>D	Comparison instructions	↪ 53
<>I	Comparison instructions	↪ 53
<>R	Comparison instructions	↪ 53
>=D	Comparison instructions	↪ 53
>=I	Comparison instructions	↪ 53

Overview

Instruction	Description	Page
>=R	Comparison instructions	↪ 53
>D	Comparison instructions	↪ 53
>I	Comparison instructions	↪ 53
>R	Comparison instructions	↪ 53
A	Combination instructions (Bit)	↪ 55
A(Combination instructions (Bit)	↪ 55
ABS	Math instructions	↪ 30
ACOS	Math instructions	↪ 30
AD	Combination instructions (Word)	↪ 63
AN	Combination instructions (Bit)	↪ 55
AN(Combination instructions (Bit)	↪ 55
ASIN	Math instructions	↪ 30
ATAN	Math instructions	↪ 30
AW	Combination instructions (Word)	↪ 63
BTD	Data type conversion instructions	↪ 51
BTI	Data type conversion instructions	↪ 51
BE	Block instructions	↪ 35
BEC	Block instructions	↪ 35
BEU	Block instructions	↪ 35
BLD	Block instructions	↪ 35
CAD	Transfer instructions	↪ 47
CALL	Block instructions	↪ 35
CAR	Transfer instructions	↪ 47
CAR1	Transfer instructions	↪ 47
CAR2	Transfer instructions	↪ 47
CAW	Transfer instructions	↪ 47
CC	Block instructions	↪ 35
CD	Counter instructions	↪ 65
CDB	Block instructions	↪ 35
CLR	Setting/resetting bit addresses	↪ 43
COS	Math instructions	↪ 30
CU	Counter instructions	↪ 65
DEC	Transfer instructions	↪ 47
DTB	Data type conversion instructions	↪ 51
DTR	Data type conversion instructions	↪ 51
EXP	Math instructions	↪ 30

Instruction	Description	Page
FN	Edge-triggered instructions	↪ 37
FP	Edge-triggered instructions	↪ 37
FR	Counter instructions	↪ 65
	Timer instructions	↪ 64
INC	Transfer instructions	↪ 47
INVD	Data type conversion instructions	↪ 51
INVI	Data type conversion instructions	↪ 51
ITB	Data type conversion instructions	↪ 51
ITD	Data type conversion instructions	↪ 51
JBI	Jump instructions	↪ 44
JC	Jump instructions	↪ 44
JCB	Jump instructions	↪ 44
JCN	Jump instructions	↪ 44
JL	Jump instructions	↪ 44
JM	Jump instructions	↪ 44
JMZ	Jump instructions	↪ 44
JN	Jump instructions	↪ 44
JNB	Jump instructions	↪ 44
JNBI	Jump instructions	↪ 44
JO	Jump instructions	↪ 44
JOS	Jump instructions	↪ 44
JP	Jump instructions	↪ 44
JPZ	Jump instructions	↪ 44
JU	Jump instructions	↪ 44
JUO	Jump instructions	↪ 44
JZ	Jump instructions	↪ 44
L	Load instructions	↪ 38
LAR1	Transfer instructions	↪ 47
LAR2	Transfer instructions	↪ 47
LD	Load instructions	↪ 38
LN	Math instructions	↪ 30
LOOP	Jump instructions	↪ 44
MOD	Math instructions	↪ 30
NEGD	Data type conversion instructions	↪ 51
NEGI	Data type conversion instructions	↪ 51
NEGR	Math instructions	↪ 30

Overview

Instruction	Description	Page
NOP	Block instructions	↪ 35
NOT	Setting/resetting bit addresses	↪ 43
O	Combination instructions (Bit)	↪ 55
O(Combination instructions (Bit)	↪ 55
OD	Combination instructions (Word)	↪ 63
ON	Combination instructions (Bit)	↪ 55
ON(Combination instructions (Bit)	↪ 55
OPN	Block instructions	↪ 35
OW	Combination instructions (Word)	↪ 63
POP	Transfer instructions	↪ 47
PUSH	Transfer instructions	↪ 47
R	Setting/resetting bit addresses	↪ 43
RLD	Shift instructions	↪ 41
RLDA	Shift instructions	↪ 41
RND	Data type conversion instructions	↪ 51
RND+	Data type conversion instructions	↪ 51
RND-	Data type conversion instructions	↪ 51
RRD	Shift instructions	↪ 41
RRDA	Shift instructions	↪ 41
S	Setting/resetting bit addresses	↪ 43
SA	Timer instructions	↪ 64
SAVE	Setting/resetting bit addresses	↪ 43
SD	Timer instructions	↪ 64
SE	Timer instructions	↪ 64
SET	Setting/resetting bit addresses	↪ 43
SIN	Math instructions	↪ 30
SLD	Shift instructions	↪ 41
SLW	Shift instructions	↪ 41
SP	Timer instructions	↪ 64
SQR	Math instructions	↪ 30
SQRT	Math instructions	↪ 30
SRD	Shift instructions	↪ 41
SRW	Shift instructions	↪ 41
SS	Timer instructions	↪ 64
SSD	Shift instructions	↪ 41
SSI	Shift instructions	↪ 41

Instruction	Description	Page
T	Transfer instructions	↪ 47
TAK	Transfer instructions	↪ 47
TAN	Math instructions	↪ 30
TAR	Transfer instructions	↪ 47
TAR1	Transfer instructions	↪ 47
TAR2	Transfer instructions	↪ 47
TRUNC	Data type conversion instructions	↪ 51
UC	Block instructions	↪ 35
X	Combination instructions (Bit)	↪ 55
X(Combination instructions (Bit)	↪ 55
XN	Combination instructions (Bit)	↪ 55
XN(Combination instructions (Bit)	↪ 55
XOD	Combination instructions (Word)	↪ 63
XOW	Combination instructions (Word)	↪ 63

3.2 Abbreviations

Abbreviation	Description
/FC	First check bit
2#	Binary constant
a	Byte address
ACCU	Register for processing bytes, words and double words
AR	Address registers, contain the area-internal or area-crossing addresses for the instructions addressed register-indirect
b	Bit address
B	area-crossing, register-indirect addressed byte
B (b1,b2)	Constant, 2byte
B (b1,b2,b3,b4)	Constant, 4byte
B#16#	Byte hexadecimal
BR	Binary result
c	Operand range
C	Counter
C#	Counter constant (BCD-coded)
CC0	Condition code
CC1	Condition code
D	area-crossing, register-indirect addressed double word

Abbreviations

Abbreviation	Description
D#	IEC date constant
DB	Data block
DBB	Data byte in the data block
DBD	Data double word in the data block
DBW	Data word in the data block
DBX	Data bit in the data block
DI	Instance data block
DIB	Data byte in the instance DB
DID	Data double word in the instance DB
DIW	Data word in the instance DB
DIX	Data bit in the instance DB
DW#16#	Double word hexadecimal
f	Timer/Counter No.
FB	Function block
FC	Functions
g	Operand range
h	Operand range
l	Input (in the PII)
i	Operand range
i8	Integer (8bit)
i16	Integer (16bit)
i32	Integer (32bit)
IB	Input byte (in the PII)
ID	Input double word (in the PII)
IW	Input word (in the PII)
k8	Constant (8bit)
k16	Constant (16bit)
k32	Constant (32bit)
L	Local data
L#	Integer constant (32bit)
LABEL	Symbolic jump address with max. 4 characters. These 4 characters can be composed of letters, numbers and the underscore "_", where the first character must be a letter. Upper and lower case are differentiated. The label ends with ":".
LB	Local data byte
LD	Local data double word
LW	Local data word

Abbreviation	Description
m	Pointer constant P#x.y (pointer)
M	Bit memory bit
MB	Bit memory byte
MD	Bit memory double word
MW	Bit memory word
n	Binary constant
OB	Organization block
OR	Or
OS	Stored overflow
OV	Overflow
p	Hexadecimal constant
P#	Pointer constant
PIQ	Process image of the outputs
PII	Process image of the inputs
PIB	Periphery input byte (direct periphery access)
PID	Periphery input double word (direct periphery access)
PIW	Periphery input word (direct periphery access)
PQB	Periphery output byte (direct periphery access)
PQD	Periphery output double word (direct periphery access)
PQW	Periphery output word (direct periphery access)
Q	Output (in the PIQ)
q	Real number (32bit floating-point number)
QB	Output byte (in the PIQ)
QD	Output double word (in the PIQ)
QW	Output word (in the PIQ)
r	Block no.
RLO	Result of (previous) logic instruction
S5T#	S5 time constant (16bit), loads the S5-Timer
SFB	System function block
SFC	System function
STA	Status
T	Timer (times)
T#	Time constant (16/32bit)
TOD#	IEC time constant
W	area-crossing, register-indirect addressed word
W#16#	Word hexadecimal

3.3 Comparison of syntax languages

Comparison

In the following overview, the German and international syntax languages of STL are compared.

Area	German	International
Input	E	I
Output	A	Q
Counter	Z	C
Periphery input byte	PEB	PIB
Periphery input word	PEW	PIW
Periphery input double word	PED	PID
Periphery output byte	PAB	PQB
Periphery output word	PAW	PQW
Periphery output double word	PAD	PQD
Combinations	U	A
	UN	AN
	U(A(
	UN(AN(
	UW	AW
	UD	AD
Time functions	SI	SP
	SV	SE
	SE	SD
	SA	SF
Counter functions	ZV	CU
	ZR	CD
Load and transfer	TAR	CAR
	TAW	CAW
	TAD	CAD
Program control	AUF	OPN
	BEA	BEU
	BEB	BEC
	TDB	CDB
	UW	AW
	UD	AD
Jump functions	SPA	JU
	SPBB	JCB
	SPBIN	JNBI

Area	German	International
	SPBNB	JNB
	SPBI	JBI
	SPBN	JCN
	SPB	JC
	SPO	JO
	SPS	JOS
	SPU	JUO
	SPZ	JZ
	SPN	JN
	SPMZ	JMZ
	SPPZ	JPZ
	SPL	JL
	SPM	JM
	SPP	JP

3.4 Differences between SPEED7 and 300V programming

General

The SPEED7-CPU's lean in the command processing against the Siemens S7-400 and differ here to the Siemens S7-300 (VIPA 300V).

These differences are listed below.

In the following, the CPU 318 from Siemens is counted for the S7-400 series from Siemens.

Status register

In opposite to the Siemens S7-300, the VIPA SPEED7-CPU's and Siemens S7-400 (CPU 318) use the status register bits OR, STA, /FC.

If your user application is based upon the circumstance that the mentioned bits in the status register are always zero (like Siemens S7-300), the program is not executable at VIPA SPEED7-CPU's and Siemens S7-400 (CPU 318).

ACCU handling at arithmetic operations

The CPU's of the Siemens S7-300 contain 2 ACCU's. At an arithmetic operation the content of the 2nd ACCU is not altered.

Whereas the SPEED7-CPU's provide 4 ACCU's. After an arithmetic operation (+I, -I, *I, /I, +D, -D, *D, /D, MOD, +R, -R, *R, /R) the content of ACCU 3 and ACCU 4 is loaded into ACCU 3 and 2.

This may cause conflicts in applications that presume an unmodified ACCU2.

RLO at jumps

The missing of the implementation of the start command bit /ER in the Siemens S7-300 may cause, under certain circumstances, deviations in the command execution of bit commands between Siemens S7-300 and VIPA SPEED7-CPU's respectively Siemens S7-400, especially at a jump to a bit conjunction chain.

Examples RLO at jumps*Example A:*

```

A I0.0
A M1.1
= M2.0 // RLO =1 Command end
JU =J001 // jumps
.....
A M7.6
A M3.0
A M3.1
→J001:
A Q2.2 // after the jump...
// Siemens S7-300 further combines
// This command is used by VIPA SPEED7,
// Siemens S7-400 and CPU 318 as first request

```

Example B:

```

A I0.0
A M1.1
= M2.0 // RLO =1 command end
A Q3.3 // first request
JU =J001 // jumps
.....
A M3.0
A M3.1
→J001:
A M3.2 // after jump ...
..... // the CPUs further combine

```

BCD consistency

At setting a timer or counter, a valid BCD value must be present in ACCU 1. The proof of this BCD value is in the Siemens S7-300 only executed when timer or counter are taken over (edge change). The SPEED7-CPU's (like the S7-400 from Siemens) always execute the verification.

Example:

```

.....
A I5.4
L MW20
S T30
// Siemens S7-300 only proofs if timer
// is actively executed
// SPEED7, Siemens S7-400 and CPU 318
// always proof (also when no condition is present)
.....

```

3.5 Registers

ACCU1 ... ACCU4 (32bit)

The ACCUs are registers for the processing of byte, words or double words. Therefore the operands are loaded in the ACCUs and combined. The result of the instruction is always in ACCU1.

ACCU	Bit
ACCU _x (x=1 ... 4)	Bit 0 ... bit 31
ACCU _x -L	Bit 0 ... bit 15
ACCU _x -H	Bit 16 ... bit 31
ACCU _x -LL	Bit 0 ... bit 7
ACCU _x -LH	Bit 8 ... bit 15
ACCU _x -HL	Bit 16 ... bit 23
ACCU _x -HH	Bit 24 ... bit 31

Address register AR1 and AR2 (32bit)

The address registers contain the area-internal or area-crossing addresses for the register-indirect addressed instructions. The address registers are 32bit wide.

The area-internal or area-crossing addresses have the following structure:

area-internal address:

00000000 00000bbb bbbbbb bbbbbbxxx

area-crossing address:

10000yyy 00000bbb bbbbbb bbbbbbxxx

Legend:	b	Byte address
	x	Bit number
	Y	Range ID
		🔗 Chap. 3.6 'Addressing examples' page 28

Status word (16bit)

The values are analysed or set by the instructions. The status word is 16bit wide.

Addressing examples

Bit	Assignment	Description
0	/FC	First check bit
1	RLO	Result of (previous) logic instruction
2	STA	Status
3	OR	Or
4	OS	Stored overflow
5	OV	Overflow
6	CC0	Condition code
7	CC1	Condition code
8	BR	Binary result
9 ... 15	not used	-

3.6 Addressing examples

Addressing example	Description
Immediate addressing	
L +27	Load 16bit integer constant "27" in ACCU1
L L#-1	Load 32bit integer constant "-1" in ACCU1
L 2#1010101010101010	Load binary constant in ACCU1
L DW#16#A0F0_BCFD	Load hexadecimal constant in ACCU1.
L "End"	Load ASCII code in ACCU1
L T#500ms	Load time value in ACCU1
L C#100	Load time value in ACCU1
L B#(100,12)	Load constant as 2byte
L B#(100,12,50,8)	Load constant as 4byte
L P#10.0	Load area-internal pointer in ACCU1
L P#E20.6	Load area-crossing pointer in ACCU1
L -2.5	Load real number in ACCU1
L D#1995-01-20	Load date
L TOD#13:20:33.125	Load time-of-day
Direct addressing	
A I 0.0	AND operation of input bit 0.0
L IB 1	Load input byte 1 in ACCU1
L IW 0	Load input word 0 in ACCU1
L ID 0	Load input double word 0 in ACCU1
Indirect addressing timer/counter	
SP T [LW 8]	Start timer; timer no. is in local data word 8

Addressing example		Description	
CU C [LW 10]		Start counter; counter no. is in local data word 10	
Memory-indirect, area-internal addressing			
A I [LD 12]e.g.: LP#22.2 T LD 12 A I [LD 12]		AND instruction; input address is in local data double word 12 as pointer	
A I [DBD 1]		AND instruction; input address is in data double word 1 of the DB as pointer	
A Q [DID 12]		AND instruction; output address is in data double word 12 of the instance DB as pointer	
A Q [MD 12]		AND instruction; output address is in bit memory double word 12 as pointer	
Register-indirect, area-internal addressing			
A I [AR1,P#12.2]		AND instruction; input address is calculated "pointer value in address register 1 + pointer P#12.2"	
Register-indirect, area-crossing addressing			
For the area-crossing, register indirect addressing the address needs an additional range-ID in the bits 24-26. The address is in the address register.			
Range-ID	Binary code	hex.	Area
P	1000 0000	80	Periphery area
I	1000 0001	81	Input area
Q	1000 0010	82	Output area
M	1000 0011	83	Bit memory area
DB	1000 0100	84	Data area
DI	1000 0101	85	Instance data area
L	1000 0110	86	Local data area
VL	1000 0111	87	Preceding local data area (access to the local data of the calling block)
L B [AR1,P#8.0]		Load byte in ACCU1; the address is calculated "pointer value in address register 1 + pointer P#8.0"	
A [AR1,P#32.3]		AND instruction; operand address is calculated "pointer value in address register 1 + pointer P#32.3"	
Addressing via parameters			
A parameter		The operand is addressed via the parameter	

Math instructions

Example for pointer calculation

Example when sum of bit addresses ≤ 7:

```
LAR1 P#8.2
UE [AR1, P#10.2]
```

*Result:*The input 18.4 is addressed
(by adding the byte and bit addresses)

Example when sum of bit addresses > 7:

```
L MD 0 at will calculated pointer, e.g. P#10.5
LAR1
UE [AR1, P#10.7]
```

Result: Addressed is input 21.4
(by adding the byte and bit addresses with carry)

3.7 Math instructions

Fixed-point arithmetic (16bit)

Math instructions of two 16bit numbers.
The result is in ACCU1 res. ACCU1-L.

Com-mand	Operand	Parameter	Function	Length in words
+I	-		Add up two integers (16bit) (ACCU1-L)=(ACCU1-L)+(ACCU2-L)	1
-I	-		Subtract two integers (16bit) (ACCU1-L)=(ACCU2-L)-(ACCU1-L)	1
I	-		Multiply two integers (16bit) (ACCU1)=(ACCU2-L)(ACCU1-L)	1
/I	-		Divide two integers (16bit) (ACCU1-L)=(ACCU2-L):(ACCU1-L) The remainder is in ACCU1-H	1

Status word	BR	CC1	CC0	OV	OS	OR	STA	RLO	/FC
Instruction depends on	-	-	-	-	-	-	-	-	-
Instruction influences	-	✓	✓	✓	✓	-	-	-	-

**Fixed-point arithmetic
(32bit)**

Math instructions of two 32bit numbers.
The result is in ACCU1.

Com-mand	Operand	Parameter	Function	Length in words
+D	-		Add up two integers (32bit) $(ACCU1)=(ACCU2)+(ACCU1)$	1
-D	-		Subtract two integers (32bit) $(ACCU1)=(ACCU2)-(ACCU1)$	1
D	-		Multiply two integers (32bit) $(ACCU1)=(ACCU2)(ACCU1)$	1
/D	-		Divide two integers (32bit) $(ACCU1)=(ACCU2):(ACCU1)$	1
MOD	-		Divide two integers (32bit) and load the rest of the division in ACCU1 $(ACCU1)=\text{remainder of } [(ACCU2):(ACCU1)]$	1

Status word	BR	CC1	CC0	OV	OS	OR	STA	RLO	/FC
Instruction depends on	-	-	-	-	-	-	-	-	-
Instruction influences	-	✓	✓	✓	✓	-	-	-	-

Math instructions

Floating-point arithmetic (32bit)

The result of the math instructions is in ACCU1. The execution time of the instruction depends on the value to calculate.

Com-mand	Operand	Parameter	Function	Length in words
+R	-		Add up two real numbers (32bit) $(ACCU1)=(ACCU2)+(ACCU1)$	1
-R	-		Subtract two real numbers (32bit) $(ACCU1)=(ACCU2)-(ACCU1)$	1
R	-		Multiply two real numbers (32bit) $(ACCU1)=(ACCU2)(ACCU1)$	1
/R	-		Divide two real numbers (32bit) $(ACCU1)=(ACCU2):(ACCU1)$	1
NEGR	-		Negate the real number in ACCU1	1
ABS	-		Form the absolute value of the real number in ACCU1	1

Status word for: R	BR	CC1	CC0	OV	OS	OR	STA	RLO	/FC
Instruction depends on	-	-	-	-	-	-	-	-	-
Instruction influences	-	✓	✓	✓	✓	-	-	-	-

Status word for: NEGR, ABS	BR	CC1	CC0	OV	OS	OR	STA	RLO	/FC
Instruction depends on	-	-	-	-	-	-	-	-	-
Instruction influences	-	-	-	-	-	-	-	-	-

Square root an square instructions (32bit)

The result of the instructions is in ACCU1.
The instructions may be interrupted by alarms.

Com-mand	Operand	Parameter	Function	Length in words
SQRT	-		Calculate the Square root of a real number in ACCU1	1
SQR	-		Form the square of a real number in ACCU1	1

Status word	BR	CC1	CC0	OV	OS	OR	STA	RLO	/FC
Instruction depends on	-	-	-	-	-	-	-	-	-
Instruction influences	-	✓	✓	✓	✓	-	-	-	-

**Logarithmic function
(32bit)**

The result of the logarithm function is in ACCU1.

The instructions may be interrupted by alarms.

Com-mand	Operand	Parameter	Function	Length in words
LN	-		Calculate the natural logarithm of a real number in ACCU1	1
EXP	-		Calculate the exponential value of a real number in ACCU1 on basis e (=2.71828)	1

Status word	BR	CC1	CC0	OV	OS	OR	STA	RLO	/FC
Instruction depends on	-	-	-	-	-	-	-	-	-
Instruction influences	-	✓	✓	✓	✓	-	-	-	-

**Trigonometrical functions
(32bit)**

The result of the trigonometrical function is in ACCU1.

The instructions may be interrupted by alarms.

Com-mand	Operand	Parameter	Function	Length in words
SIN ¹	-		Calculate the sine of the real number	1
ASIN ²	-		Calculate the arcsine of the real number	1
COS ¹	-		Calculate the cosine of the real number	1
ACOS ²	-		Calculate the arccosine of the real number	1
TAN ¹	-		Calculate the tangent of the real number	1
ATAN ²	-		Calculate the arctangent of the real number	1

1) Specify the angle in radians; the angle must be given as a floating point value in ACCU 1.

2) The result is an angle in radians.

Status word	BR	CC1	CC0	OV	OS	OR	STA	RLO	/FC
Instruction depends on	-	-	-	-	-	-	-	-	-
Instruction influences	-	✓	✓	✓	✓	-	-	-	-

Math instructions

Addition of constants Addition of integer constants to ACCU1.
The condition code bits are not affected.

Com-mand	Operand	Parameter	Function	Length in words
+	i8		Add an 8bit integer constant	1
+	i16		Add a 16bit integer constant	2
+	i32		Add a 32bit integer constant	3

Addition via address register Adding a 16bit integer to contents of address register.
The value is in the instruction or in ACCU1-L.
Condition code bits are not affected.

Com-mand	Operand	Parameter	Function	Length in words
+AR1	-		Add the contents of ACCU1-L to AR1	1
+AR1	m		Add pointer constant to the contents of AR1	2
+AR2	-		Add the contents of ACCU1-L to AR2	1
+AR2	m		Add pointer constant to the contents of AR2	2

3.8 Block instructions

Block call instructions

Com-mand	Operand	Parameter	Function	Length in words
CALL	FB p DB r	0 ... 8191 0 ... 8191	Unconditional call of a FB, with parameter transfer	
CALL	SFB p DB r	0 ... 8191 0 ... 8191	Unconditional call of a SFB, with parameter transfer	
CALL	FC p		Unconditional call of a function, with parameter transfer	
CALL	SFC p		Unconditional call of a SFC, with parameter transfer	
UC	FB q FC q Parameter	0 ... 8191	Unconditional call of blocks, without parameter transfer FB/FC call via parameters	1/2
CC	FB q FC q Parameter	0 ... 8191	Conditional call of blocks, without parameter transfer FB/FC call via parameters	1/2
OPN	DB p DI p Parameter	0 ... 8191	Open a data block Open a instance data block Open a data block via parameter	1/2 2 2

Status word for: CALL, UC	BR	CC1	CC0	OV	OS	OR	STA	RLO	/FC
Instruction depends on	-	-	-	-	-	-	-	-	-
Instruction influences	-	-	-	-	0	0	1	-	0

Status word for: CC	BR	CC1	CC0	OV	OS	OR	STA	RLO	/FC
Instruction depends on	-	-	-	-	-	-	-	✓	-
Instruction influences	-	-	-	-	0	0	1	-	0

Status word for: OPN	BR	CC1	CC0	OV	OS	OR	STA	RLO	/FC
Instruction depends on	-	-	-	-	-	-	-	-	-
Instruction influences	-	-	-	-	-	-	-	-	-

Program display and Null operation instructions

Block end instructions

Com-mand	Operand	Parameter	Function	Length in words
BE			End block	1
BEU			End block unconditionally	1
BEC			End block if RLO="1"	1

Status word for: BE, BEU	BR	CC1	CC0	OV	OS	OR	STA	RLO	/FC
Instruction depends on	-	-	-	-	-	-	-	-	-
Instruction influences	-	-	-	-	0	0	1	-	0

Status word for: BEC	BR	CC1	CC0	OV	OS	OR	STA	RLO	/FC
Instruction depends on	-	-	-	-	-	-	-	✓	-
Instruction influences	-	-	-	-	✓	0	1	1	0

Exchanging shared data block an instance data block

Exchanging the two current data blocks. The current shared data block becomes the current instance data block and vice versa.

The condition code bits are not affected.

Com-mand	Operand	Parameter	Function	Length in words
CDB			Exchange shared data block and instant data block	1

3.9 Program display and Null operation instructions

The status word is not affected.

Com-mand	Operand	Parameter	Function	Length in words
BLD	0 ... 255		Program display instruction: is treated by the CPU like a null operation instruction	1
NOP	0 1		Null operation instruction	1

3.10 Edge-triggered instructions

Edge-triggered instructions

Detection of an edge change. The current signal state of the RLO is compared with the signal state of the instruction or edge bit memory.

FP detects a change in the RLO from "0" to "1"

FN detects a change in the RLO from "1" to "0"

Command	Operand	Parameter	Function	Length in words
FP	I/Q a.b	0.0 ... 2047.7	Detecting the positive edge in the RLO. The bit addressed in the instruction is the auxiliary edge bit memory.	2
	M a.b	0.0 ... 8191.7		2
	L a.b	parameterizable		2
	DBX a.b	0.0 ... 65535.7		2
	DIX a.b	0.0 ... 65535.7		2
	c [AR1,m]			2
	c [AR2,m]			2
	[AR1,m]			2
	[AR2,m]			2
	Parameter			2
FN	I/Q a.b	0.0 ... 2047.7	Detecting the negative edge in the RLO. The bit addressed in the instruction is the auxiliary edge bit memory	2
	M a.b	0.0 ... 8191.7		2
	L a.b	parameterizable		2
	DBX a.b	0.0 ... 65535.7		2
	DIX a.b	0.0 ... 65535.7		2
	c [AR1,m]			2
	c [AR2,m]			2
	[AR1,m]			2
	[AR2,m]			2
	Parameter			2

Status word for: FP, FN	BR	CC1	CC0	OV	OS	OR	STA	RLO	/FC
Instruction depends on	-	-	-	-	-	-	-	✓	-
Instruction influences	-	-	-	-	-	0	✓	✓	1

3.11 Load instructions

Load instructions Loading address identifiers into ACCU1. The contents of ACCU1 and ACCU2 are saved first.

The status word is not affected.

Com-mand	Operand	Parameter	Function	Length in words
L			Load ...	
	IB a		input byte	1/2
	QB a		output byte	1/2
	PIB a		periphery input byte	2
	MB a	0.0 ... 8191	bit memory byte	1/2
	LB a	parameterizable	local data byte	2
	DBB a	0.0 ... 65535	data byte	2
	DIB a	0.0 ... 65535	instance data byte	2
			... in ACCU1	
	g [AR1,m]		register-indirect, area-internal (AR1)	2
	g [AR2,m]		register-indirect, area-internal (AR2)	2
	B [AR1,m]		area-crossing (AR1)	2
	B [AR2,m]		area-crossing (AR2)	2
	Parameter		via parameters	2
L			Load ...	
	IW a	0.0 ... 2046	input word	1/2
	QW a	0.0 ... 2046	output word	1/2
	PIW a	0.0 ... 8190	periphery input word	2
	MW a	0.0 ... 8190	bit memory word	1/2
	LW a	parameterizable	local data word	2
	DBW a	0.0 ... 65534	data word	1/2
	DIW a	0.0 ... 65534	instance data word	1/2
			... in ACCU1-L	
	h [AR1,m]		register-indirect, area-internal (AR1)	2
	h [AR2,m]		register-indirect, area-internal (AR2)	2
	W [AR1,m]		area-crossing (AR1)	2
	W [AR2,m]		area-crossing (AR2)	2
	Parameter		via parameters	2
L			Load ...	
	ID a	0.0 ... 2044	input double word	1/2
	QD a	0.0 ... 2044	output double word	1/2
	PID a	0.0 ... 8188	periphery input double word	2

Com-mand	Operand	Parameter	Function	Length in words
	MD a	0.0 ... 8188	bit memory double word	1/2
	LD a	parameterizable	local data double word	2
	DBD a	0.0 ... 65532	data double word	2
	DID a	0.0 ... 65532	instance data double word	2
			... in ACCU1-L.	
	i [AR1,m]		register-indirect, area-internal (AR1)	2
	i [AR2,m]		register-indirect, area-internal (AR2)	2
	D [AR1,m]		area-crossing (AR1)	2
	D [AR2,m]		area-crossing (AR2)	2
	Parameter		via parameters	2
L			Load ...	
	k8		8bit constant in ACCU1-LL	1
	k16		16bit constant in ACCU1-L	2
	k32		32bit constant in ACCU1	3
	Parameter		Load constant in ACCU1 (addressed via parameters)	2
L	2#n		Load 16bit binary constant in ACCU1-L	2
			Load 32bit binary constant in ACCU1	3
L	B#8#p		Load 8bit hexadecimal constant in ACCU1-LL	1
	W#16#p		Load 16bit hexadecimal constant in ACCU1-L	2
	DW#16#p		Load 32bit hexadecimal constant in ACCU1	3
L	x		Load one character	
L	xx		Load two characters	2
L	xxx		Load three characters	
L	xxxx		Load four characters	3
L	D# Date		Load IEC-date (BCD-coded)	3
L	S5T# time value		Load time constant (16bit)	2
L	TOD# time value		Load 32bit time constant (IEC-time-of-day)	3
L	T# time value		Load 16bit time constant Load 32bit time constant	2 3
L	C# counter value		Load 16bit counter constant	2
L	P# bit pointer		Load bit pointer	3
L	L# Integer		Load 32bit integer constant	3
L	Real		Load real number	3

Load instructions

Load instructions for timer and counter Load a time or counter value in ACCU1, before the recent content of ACCU1 is saved in ACCU2.

The status word is not affected.

Com-mand	Operand	Parameter	Function	Length in words
L	T f Timer para.	0 ... 511	Load time value Load time value (addressed via parameters)	1/2 2
L	Z f Counter para.	0 ... 511	Load counter value Load counter value (addressed via parameters)	1/2 2
LC	T f Timer para.	0 ... 511	Load time value BCD-coded Load time value BCD-coded (addressed via parameters)	1/2 2
LC	Z f Counter para.	0 ... 511	Load counter value BCD-coded Load counter value BCD-coded (addressed via parameters)	1/2 2

3.12 Shift instructions

Shift instructions

Shifting the contents of ACCU1 and ACCU1-L to the left or right by the specified number of places. If no address identifier is specified, shift the number of places into ACCU2-LL. Any positions that become free are padded with zeros or the sign.

The last shifted bit is in condition code bit CC1.

Com-mand	Operand	Parameter	Function	Length in words
SLW	-		Shift the contents of ACCU1-L to the left. Positions that become free are provided with zeros.	1
SLW	0 ... 15			
SLD	-		Shift the contents of ACCU1 to the left. Positions that become free are provided with zeros.	1
SLD	0 ... 32			
SRW	-		Shift the contents of ACCU1-L to the right. Positions that become free are provided with zeros	1
SRW	0 ... 15			
SRD	-		Shift the contents of ACCU1 to the right. Positions that become free are provided with zeros	1
SRD	0 ... 32			
SSI	-		Shift the contents of ACCU1-L to the right with sign. Positions that become free are provided with the sign (bit 15)	1
SSI	0 ... 15			
SSD	-		Shift the contents of ACCU1 to the right with sign	1
SSD	0 ... 32			

Status word	BR	CC1	CC0	OV	OS	OR	STA	RLO	/FC
Instruction depends on	-	-	-	-	-	-	-	-	-
Instruction influences	-	✓	✓	✓	-	-	-	-	-

Shift instructions

Rotation instructions

Rotate the contents of ACCU1 to the left or right by the specified number of places. If no address identifier is specified, rotate the number of places into ACCU2-LL.

Com-mand	Operand	Parameter	Function	Length in words
RLD	-		Rotate the contents of ACCU1 to the left	1
RLD	0 ... 32			
RRD	-		Rotate the contents of ACCU1 to the right	1
RRD	0 ... 32			
RLDA	-		Rotate the contents of ACCU1 one bit position to the left, via CC1 bit	
RRDA	-		Rotate the contents of ACCU1 one bit position to the right, via CC1 bit	

Status word for: RLD, RRD	BR	CC1	CC0	OV	OS	OR	STA	RLO	/FC
Instruction depends on	-	-	-	-	-	-	-	-	-
Instruction influences	-	✓	✓	✓	-	-	-	-	-

Status word for: RLDA, RRDA	BR	CC1	CC0	OV	OS	OR	STA	RLO	/FC
Instruction depends on	-	-	-	-	-	-	-	-	-
Instruction influences	-	✓	0	0	-	-	-	-	-

3.13 Setting/resetting bit addresses

Setting/resetting bit addresses

Assign the value "1" or "0" or the RLO to the addressed instructions.

Com-mand	Operand	Parameter	Function	Length in words
S			Set ...	
	I/Q a.b	0.0 ... 2047.7	input/output to "1"	1/2
	M a.b	0.0 ... 8191.7	set bit memory to "1"	1/2
	L a.b	parameterizable	local data bit to "1"	2
	DBX a.b	0.0 ... 65535.7	data bit to "1"	2
	DIX a.b	0.0 ... 65535.7	instance data bit to "1"	2
	c [AR1,m]		register-indirect, area-internal (AR1)	2
	c [AR2,m]		register-indirect, area-internal (AR2)	2
	[AR1,m]		area-crossing (AR1)	2
	[AR2,m]		area-crossing (AR2)	2
	Parameter		via parameters	2
R			Reset ...	
	I/Q a.b	0.0 ... 2047.7	input/output to "0"	1/2
	M a.b	0.0 ... 8191.7	set bit memory to "0"	1/2
	L a.b	parameterizable	local data bit to "0"	2
	DBX a.b	0.0 ... 65535.7	data bit to "0"	2
	DIX a.b	0.0 ... 65535.7	instance data bit to "0"	2
	c [AR1,m]		register-indirect, area-internal (AR1)	2
	c [AR2,m]		register-indirect, area-internal (AR2)	2
	[AR1,m]		area-crossing (AR1)	2
	[AR2,m]		area-crossing (AR2)	2
	Parameter		via parameters	2
=			Assign ...	
	I/Q a.b	0.0 ... 2047.7	RLO to input/output	1/2
	M a.b	0.0 ... 8191.7	RLO to bit memory	1/2
	L a.b	parameterizable	RLO to local data bit	2
	DBX a.b	0.0 ... 65535.7	RLO to data bit	2
	DIX a.b	0.0 ... 65535.7	RLO to instance data bit	2
	c [AR1,m]		register-indirect, area-internal (AR1)	2
	c [AR2,m]		register-indirect, area-internal (AR2)	2
	[AR1,m]		area-crossing (AR1)	2
	[AR2,m]		area-crossing (AR2)	2
	Parameter		via parameters	2

Jump instructions

Status word for: S, R, =	BR	CC1	CC0	OV	OS	OR	STA	RLO	/FC
Instruction depends on	-	-	-	-	-	-	-	✓	-
Instruction influences	-	-	-	-	-	0	✓	-	0

Instructions directly affecting the RLO

The following instructions have a directly effect on the RLO.

Com-mand	Operand	Parameter	Function	Length in words
CLR			Set RLO to "0"	1
SET			Set RLO to "1"	1
NOT			Negate RLO	1
SAVE			Save RLO into BR-bit	1

Status word for: CLR	BR	CC1	CC0	OV	OS	OR	STA	RLO	/FC
Instruction depends on	-	-	-	-	-	-	-	-	-
Instruction influences	-	-	-	-	-	0	0	0	0

Status word for: SET	BR	CC1	CC0	OV	OS	OR	STA	RLO	/FC
Instruction depends on	-	-	-	-	-	-	-	-	-
Instruction influences	-	-	-	-	-	0	1	1	0

Status word for: NOT	BR	CC1	CC0	OV	OS	OR	STA	RLO	/FC
Instruction depends on	-	-	-	-	-	✓	-	✓	-
Instruction influences	-	-	-	-	-	-	1	✓	-

Status word for: SAVE	BR	CC1	CC0	OV	OS	OR	STA	RLO	/FC
Instruction depends on	-	-	-	-	-	-	-	✓	-
Instruction influences	✓	-	-	-	-	-	-	-	-

3.14 Jump instructions

Jump label

The jump label is a symbolic jump address with max. 4 characters. These 4 characters can be composed of letters, numbers and the underscore "_", where the 1. character must be a letter. Upper and lower case are differentiated. The colon ":" after the jump label identifies the jump label and initiates the instruction part.

Jump, depending on conditions.

8-bit operands have a jump width of (-128...+127)

16-bit operands of (-32768...-129) or (+128...+32767)

Com-mand	Operand	Parameter	Function	Length in words
JU	LABEL		Jump unconditionally	1/2
JC	LABEL		Jump if RLO="1"	1/2
JCN	LABEL		Jump if RLO="0"	2
JCB	LABEL		Jump if RLO="1" Save the RLO in the BR-bit	2
JNB	LABEL		Jump if RLO="0" Save the RLO in the BR-bit	2
JBI	LABEL		Jump if BR="1"	2
JNBI	LABEL		Jump if BR="0"	2
JO	LABEL		Jump on stored overflow (OV="1")	1/2
JOS	LABEL		Jump on stored overflow (OS="1")	2
JUO	LABEL		Jump if "unordered instruction" (CC1=1 and CC0=1)	2
JZ	LABEL		Jump if result=0 (CC1=0 and CC0=0)	1/2
JP	LABEL		Jump if result>0 (CC1=1 and CC0=0)	1/2
JM	LABEL		Jump if result < 0 (CC1=0 and CC0=1)	1/2
JN	LABEL		Jump if result ≠ 0 (CC1=1 and CC0=0) or (CC1=0) and (CC0=1)	1/2
JMZ	LABEL		Jump if result ≤ 0 (CC1=0 and CC0=1) or (CC1=0 and CC0=0)	2
JPZ	LABEL		Jump if result ≥ 0 (CC1=1 and CC0=0) or (CC1=0 and CC0=0)	2
JL	LABEL		Jump distributor This instruction is followed by a list of jump instructions. The operand is a jump label to subsequent instructions in this list. ACCU1-L-L contains the number of the jump instruction to be executed	2
LOOP	LABEL		Decrement ACCU1-L and jump if ACCU1-L ≠ 0 (loop programming)	2

Status word for: JU, JL, LOOP	BR	CC1	CC0	OV	OS	OR	STA	RLO	/FC
Instruction depends on	-	-	-	-	-	-	-	-	-
Instruction influences	-	-	-	-	-	-	-	-	-

Jump instructions

Status word for: JC, JCN	BR	CC1	CC0	OV	OS	OR	STA	RLO	/FC
Instruction depends on	-	-	-	-	-	-	-	✓	-
Instruction influences	-	-	-	-	-	0	1	1	0

Status word for: JCB, JNB	BR	CC1	CC0	OV	OS	OR	STA	RLO	/FC
Instruction depends on	-	-	-	-	-	-	-	✓	-
Instruction influences	✓	-	-	-	-	0	1	1	0

Status word for: JBI, JNBI	BR	CC1	CC0	OV	OS	OR	STA	RLO	/FC
Instruction depends on	✓	-	-	-	-	-	-	-	-
Instruction influences	-	-	-	-	-	0	1	-	0

Status word for: JO	BR	CC1	CC0	OV	OS	OR	STA	RLO	/FC
Instruction depends on	-	-	-	✓	-	-	-	-	-
Instruction influences	-	-	-	-	-	-	-	-	-

Status word for: JOS	BR	CC1	CC0	OV	OS	OR	STA	RLO	/FC
Instruction depends on	-	-	-	-	✓	-	-	-	-
Instruction influences	-	-	-	-	0	-	-	-	-

Status word for: JUO, JZ, JP, JM, JN, JMZ, JPZ	BR	CC1	CC0	OV	OS	OR	STA	RLO	/FC
Instruction depends on	-	✓	✓	-	-	-	-	-	-
Instruction influences	-	-	-	-	-	-	-	-	-

3.15 Transfer instructions

Transfer instructions Transfer the contents of ACCU1 into the addressed operand.
The status word is not affected.

Com-mand	Operand	Parameter	Function	Length in words
T			Transfer the contents of ACCU1-LL to ...	
	IB a	0.0 ... 2047	input byte	1/2
	QB a	0.0 ... 2047	output byte	1/2
	PQB a	0.0 ... 8191	periphery output byte	1/2
	MB a	0.0 ... 8191	bit memory byte	1/2
	LB a	parameterizable	local data byte	2
	DBB a	0.0 ... 65535	data byte	2
	DIB a	0.0 ... 65535	instance data byte	2
	g [AR1,m]		register-indirect, area-internal (AR1)	2
	g [AR2,m]		register-indirect, area-internal (AR2)	2
	B [AR1,m]		area-crossing (AR1)	2
	B [AR2,m]		area-crossing (AR2)	2
	Parameter		via parameters	2
	T			Transfer the contents of ACCU1-L to ...
IW		0.0 ... 2046	input word	1/2
QW		0.0 ... 2046	output word	1/2
PQW		0.0 ... 8190	periphery output word	1/2
MW		0.0 ... 8190	bit memory word	1/2
LW		parameterizable	local data word	2
DBW		0.0 ... 65534	data word	2
DIW		0.0 ... 65534	instance data word	2
h [AR1,m]			register-indirect, area-internal (AR1)	2
h [AR2,m]			register-indirect, area-internal (AR2)	2
W [AR1,m]			area-crossing (AR1)	2
W [AR2,m]			area-crossing (AR2)	2
Parameter			via parameters	2
T				Transfer the contents of ACCU1 to ...

Transfer instructions

Com-mand	Operand	Parameter	Function	Length in words
	ID	0.0 ... 2044	input double word	1/2
	QD	0.0 ... 2044	output double word	1/2
	PQD	0.0 ... 8188	periphery output double word	1/2
	MD	0.0 ... 8188	bit memory double word	1/2
	LD	parameterizable	local data double word	2
	DBD	0.0 ... 65532	data double word	2
	DID	0.0 ... 65532	instance data double word	2
	i [AR1,m]		register-indirect, area-internal (AR1)	2
	i [AR2,m]		register-indirect, area-internal (AR2)	2
	D [AR1,m]		area-crossing (AR1)	2
	D [AR2,m]		area-crossing (AR2)	2
	Parameter		via parameters	2

Load and transfer instructions for address register

Load a double word from a memory area or a register into AR1 or AR2.
The status word is not affected.

Com-mand	Operand	Parameter	Function	Length in words
LAR1			Load the contents from ...	
	-		ACCU1	1
	AR2		address register 2	1
	DBD a	0 ... 65532	data double word	2
	DID a	0 ... 65532	instance data double word	2
	m		32bit constant as pointer	3
	LD a	parameterizable	local data double word	2
	MD a	0 ... 8188	bit memory double word	2
		... into AR1		
LAR2			Load the contents from ...	
	-		ACCU1	1
	DBD a	0 ... 65532	data double word	2
	DID a	0 ... 65532	instance data double word	2
	m		32bit constant as pointer	3
	LD a	parameterizable	local data double word	2
	MD a	0 ... 8188	bit memory double word.	2
		... into AR2		
TAR1			Transfer the contents from AR1 to ...	
	-		ACCU1	1
	AR2		address register 2	1
	DBD a	0 ... 65532	data double word	2
	DID a	0 ... 65532	instance data double word	2
	LD a	parameterizable	local data double word	2
	MD a	0 ... 8188	bit memory double word	2
TAR2			Transfer the contents from AR2 to...	
	-		ACCU1	1
	DBD a	0 ... 65532	data double word	2
	DID a	0 ... 65532	instance data double word	2
	LD a	parameterizable	local data double word	2
	MD a	0 ... 8188	bit memory double word	2
TAR			Exchange the contents of AR1 and AR2	1

Transfer instructions

Load and transfer instructions for the status word

Command	Operand	Parameter	Function	Length in words
L	STW		Load status word in ACCU1	
T	STW		Transfer ACCU1 (bits 0 ... 8) into status word	

Status word for: L STW	BR	CC1	CC0	OV	OS	OR	STA	RLO	/FC
Instruction depends on	✓	✓	✓	✓	✓	✓	✓	✓	0
Instruction influences	-	-	-	-	-	-	-	-	-

Status word for: T STW	BR	CC1	CC0	OV	OS	OR	STA	RLO	/FC
Instruction depends on	-	-	-	-	-	-	-	-	-
Instruction influences	✓	✓	✓	✓	✓	-	-	✓	-

Load instructions for DB number and DB length

Load the number/length of a data block to ACCU1. The old contents of ACCU1 are saved into ACCU2.

The condition code bits are not affected.

Command	Operand	Parameter	Function	Length in words
L	DBNO		Load number of data block	1
L	DINO		Load number of instance data block	1
L	DBLG		Load length of data block into byte	1
L	DILG		Load length of instance data block into byte	1

ACCU transfer instructions, increment, decrement

The status word is not affected.

Command	Operand	Parameter	Function	Length in words
CAW	-		Reverse the order of the bytes in ACCU1-LL, LH becomes HL, LL	1
CAD	-		Reverse the order of the bytes in ACCU1 LL, LH, HL, HH becomes HH, HL, LH, LL	1
TAK	-		Swap the contents of ACCU1 and ACCU2	1
ENT	-		The contents of ACCU2 and ACCU3 are transferred to ACCU3 and ACCU4	
LEAVE	-		The contents of ACCU3 and ACCU4 are transferred to ACCU2 and ACCU3	
PUSH	-		The contents of ACCU1, ACCU2 and ACCU3 are transferred to ACCU2, ACCU3 and ACCU4	1
POP	-		The contents of ACCU2, ACCU3 and ACCU4 are transferred to ACCU1, ACCU2 and ACCU3	1
INC	0 ... 255		Increment ACCU1-LL	1
DEC	0 ... 255		Decrement ACCU1-LL	1

3.16 Data type conversion instructions**Data type conversion instructions**

The results of the conversion are in ACCU1. When converting real numbers, the execution time depends on the value.

Command	Operand	Parameter	Function	Length in words
BTI	-		Convert contents of ACCU1 from BCD to integer (16bit) (BCD to Int.)	1
BTD	-		Convert contents of ACCU1 from BCD to integer (32bit) (BCD to Doubleint.)	1
DTR	-		Convert cont. of ACCU1 from integer (32bit) to Real number (32bit) (Doubleint. to Real)	1
ITD	-		Convert contents of ACCU1 from integer (16bit) to integer (32bit) (Int. to Doubleint)	1

Status word	BR	CC1	CC0	OV	OS	OR	STA	RLO	/FC
Instruction depends on	-	-	-	-	-	-	-	-	-
Instruction influences	-	-	-	-	-	-	-	-	-

Data type conversion instructions

Command	Operand	Parameter	Function	Length in words
ITB	-		Convert contents of ACCU1 from integer (16bit) to BCD 0 ... +/-999 (Int. To BCD)	1
DTB	-		Convert contents of ACCU1 from integer (32bit) to BCD 0 ... +/-9 999 999 (Doubleint. To BCD)	1
RND	-		Convert a real number to 32bit integer	1
RND-	-		Convert a real number to 32bit integer The number is rounded next hole number	1
RND+	-		Convert real number to 32bit integer It is rounded up to the next integer	1
TRUNC	-		Convert real number to 32bit integer The places after the decimal point are truncated	1

Status word	BR	CC1	CC0	OV	OS	OR	STA	RLO	/FC
Instruction depends on	-	-	-	-	-	-	-	-	-
Instruction influences	-	-	-	✓	✓	-	-	-	-

Complement creation

Com- mand	Operand	Parameter	Function	Length in words
INVI	-		Forms the ones complement of ACCU1-L	1
INVD	-		Forms the ones complement of ACCU1	1
NEGI	-		Forms the twos complement of ACCU1-L (integer)	1
NEGD	-		Forms the twos complement of ACCU1 (double integer)	1

Status word for: INVI, INVD	BR	CC1	CC0	OV	OS	OR	STA	RLO	/FC
Instruction depends on	-	-	-	-	-	-	-	-	-
Instruction influences	-	-	-	-	-	-	-	-	-

Status word for: NEGI, NEGD	BR	CC1	CC0	OV	OS	OR	STA	RLO	/FC
Instruction depends on	-	-	-	-	-	-	-	-	-
Instruction influences	-	✓	✓	✓	✓	-	-	-	-

3.17 Comparison instructions

Comparison instructions with integer (16bit) Comparing the integer (16bit) in ACCU1-L and ACCU2-L.
RLO=1, if condition is satisfied.

Com-mand	Operand	Parameter	Function	Length in words
==I	-		ACCU2-L = ACCU1-L	1
<>I	-		ACCU2-L different to ACCU1-L	1
<I	-		ACCU2-L < ACCU1-L	1
<=I	-		ACCU2-L <= ACCU1-L	1
>I	-		ACCU2-L > ACCU1-L	1
>=I	-		ACCU2-L >= ACCU1-L	1

Status word	BR	CC1	CC0	OV	OS	OR	STA	RLO	/FC
Instruction depends on	-	-	-	-	-	-	-	-	-
Instruction influences	-	✓	✓	0	-	0	✓	✓	1

Comparison instructions with integer (32bit) Comparing the integer (32bit) in ACCU1 and ACCU2.
RLO=1, if condition is satisfied.

Com-mand	Operand	Parameter	Function	Length in words
==D	-		ACCU2 = ACCU1	1
<>D	-		ACCU2 different to ACCU1	1
<D	-		ACCU2 < ACCU1	1
<=D	-		ACCU2 <= ACCU1	1
>D	-		ACCU2 > ACCU1	1
>=D	-		ACCU2 >= ACCU1	1

Status word	BR	CC1	CC0	OV	OS	OR	STA	RLO	/FC
Instruction depends on	-	-	-	-	-	-	-	-	-
Instruction influences	-	✓	✓	0	-	0	✓	✓	1

Comparison instructions

Comparison instructions with 32bit real number

Comparing the 32bit real numbers in ACCU1 and ACCU2.

RLO=1, is condition is satisfied.

The execution time of the instruction depends on the value to be compared.

Com-mand	Operand	Parameter	Function	Length in words
==R	-		ACCU2 = ACCU1	1
<>R	-		ACCU2 different to ACCU1	1
<R	-		ACCU2 < ACCU1	1
<=R	-		ACCU2 <= ACCU1	1
>R	-		ACCU2 > ACCU1	1
>=R	-		ACCU2 >= ACCU1	1

Status word	BR	CC1	CC0	OV	OS	OR	STA	RLO	/FC
Instruction depends on	-	-	-	-	-	-	-	-	-
Instruction influences	-	✓	✓	✓	✓	0	✓	✓	1

3.18 Combination instructions (Bit)

Combination instructions with bit operands Examining the signal state of the addressed instruction and gating the result with the RLO according to the appropriate logic function.

Com-mand	Operand	Parameter	Function	Length in words
A			AND operation at signal state "1"	
	I/Q a.b	0.0 ... 2047.7	Input/output	1/2
	M a.b	0.0 ... 8191.7	Bit memory	1/2
	L a.b	parameterizable	Local data bit	2
	DBX a.b	0.0 ... 65535.7	Data bit	2
	DIX a.b	0.0 ... 65535.7	Instance data bit	2
	c [AR1,m]		register-indirect, area-internal (AR1)	2
	c [AR2,m]		register-indirect, area-internal (AR2)	2
	[AR1,m]		area-crossing (AR1)	2
	[AR2,m]		area-crossing (AR2)	2
	Parameter		via parameters	2
AN			AND operation of signal state "0"	
	I/Q a.b	0.0 ... 2047.7	Input/output	1/2
	M a.b	0.0 ... 8191.7	Bit memory	1/2
	L a.b	parameterizable	Local data bit	2
	DBX a.b	0.0 ... 65535.7	Data bit	2
	DIX a.b	0.0 ... 65535.7	Instance data bit	2
	c [AR1,m]		register-indirect, area-internal (AR1)	2
	c [AR2,m]		register-indirect, area-internal (AR2)	2
	[AR1,m]		area-crossing (AR1)	2
	[AR2,m]		area-crossing (AR2)	2
	Parameter		via parameters	2

Status word for: A, AN	BR	CC1	CC0	OV	OS	OR	STA	RLO	/FC
Instruction depends on	-	-	-	-	-	✓	-	✓	✓
Instruction influences	-	-	-	-	-	✓	✓	✓	1

Com-mand	Operand	Parameter	Function	Length in words
O			OR operation at signal state "1"	
	I/Q a.b	0.0 ... 2047.7	Input/output	1/2
	M a.b	0.0 ... 8191.7	Bit memory	1/2

Combination instructions (Bit)

Com-mand	Operand	Parameter	Function	Length in words
	L a.b	parameterizable	Local data bit	2
	DBX a.b	0.0 ... 65535.7	Data bit	2
	DIX a.b	0.0 ... 65535.7	Instance data bit	2
	c [AR1,m]		register-indirect, area-internal (AR1)	2
	c [AR2,m]		register-indirect, area-internal (AR2)	2
	[AR1,m]		area-crossing (AR1)	2
	[AR2,m]		area-crossing (AR2)	2
	Parameter		via parameters	2
ON			OR operation at signal state "0"	
	I/Q a.b	0.0 ... 2047.7	Input/output	1/2
	M a.b	0.0 ... 8191.7	Bit memory	1/2
	L a.b	parameterizable	Local data bit	2
	DBX a.b	0.0 ... 65535.7	Data bit	2
	DIX a.b	0.0 ... 65535.7	Instance data bit	2
	c [AR1,m]		register-indirect, area-internal (AR1)	2
	c [AR2,m]		register-indirect, area-internal (AR2)	2
	[AR1,m]		area-crossing (AR1)	2
	[AR2,m]		area-crossing (AR2)	2
	Parameter		via parameters	2

Status word for: O, ON	BR	CC1	CC0	OV	OS	OR	STA	RLO	/FC
Instruction depends on	-	-	-	-	-	-	-	✓	✓
Instruction influences	-	-	-	-	-	0	✓	✓	1

Com-mand	Operand	Parameter	Function	Length in words
X			EXCLUSIVE-OR operation at signal state "1"	
	I/Q a.b	0.0 ... 2047.7	Input/output	1/2
	M a.b	0.0 ... 8191.7	Bit memory	1/2
	L a.b	parameterizable	Local data bit	2
	DBX a.b	0.0 ... 65535.7	Data bit	2
	DIX a.b	0.0 ... 65535.7	Instance data bit	2
	c [AR1,m]		register-indirect, area-internal (AR1)	2
	c [AR2,m]		register-indirect, area-internal (AR2)	2
	[AR1,m]		area-crossing (AR1)	2
	[AR2,m]		area-crossing (AR2)	2
	Parameter		via parameters	2
	XN			EXCLUSIVE-OR operation at signal state "0"
I/Q a.b		0.0 ... 2047.7	Input/output	1/2
M a.b		0.0 ... 8191.7	Bit memory	1/2
L a.b		parameterizable	Local data bit	2
DBX a.b		0.0 ... 65535.7	Data bit	2
DIX a.b		0.0 ... 65535.7	Instance data bit	2
c [AR1,m]			register-indirect, area-internal (AR1)	2
c [AR2,m]			register-indirect, area-internal (AR2)	2
[AR1,m]			area-crossing (AR1)	2
[AR2,m]			area-crossing (AR2)	2
Parameter			via parameters	2

Status word for: X, XN	BR	CC1	CC0	OV	OS	OR	STA	RLO	/FC
Instruction depends on	-	-	-	-	-	-	-	✓	✓
Instruction influences	-	-	-	-	-	0	✓	✓	1

Combination instructions (Bit)

Combination instructions with parenthetical expressions

Saving the bits BR, RLO, OR and a function ID (A, AN, ...) at the nesting stack.
For each block 7 nesting levels are possible.

Com-mand	Operand	Parameter	Function	Length in words
A(AND left parenthesis	1
AN(AND-NOT left parenthesis	1
O(OR left parenthesis	1
ON(OR-NOT left parenthesis	1
X(EXCLUSIVE-OR left parenthesis	1
XN(EXCLUSIVE-OR-NOT left parenthesis	1
)			Right parenthesis; popping an entry off the nesting stack. Gating RLO with the current RLO in the processor.	1

Status word for: A(, AN(, O(, ON(, X(, XN(BR	CC1	CC0	OV	OS	OR	STA	RLO	/FC
Instruction depends on	✓	-	-	-	-	✓	-	✓	✓
Instruction influences	-	-	-	-	-	0	1	-	0

Status word for:)	BR	CC1	CC0	OV	OS	OR	STA	RLO	/FC
Instruction depends on	-	-	-	-	-	-	-	✓	-
Instruction influences	✓	-	-	-	-	✓	1	✓	1

ORing of AND operations

The ORing of AND operations is implemented according the rule: AND before OR.

Com-mand	Operand	Parameter	Function	Length in words
O			OR operations of AND functions according the rule: AND before OR	1

Status word	BR	CC1	CC0	OV	OS	OR	STA	RLO	/FC
Instruction depends on	-	-	-	-	-	✓	-	✓	✓
Instruction influences	-	-	-	-	-	✓	1	-	✓

Combination instructions with timer and counters

Examining the signal state of the addressed timer/counter and gating the result with the RLO according to the appropriate logic function.

Com-mand	Operand	Parameter	Function	Length in words
A			AND operation at signal state	
	T f	0 ... 511	Timer	1/2
	C f	0 ... 511	Counter	1/2
	Timer para.		Timer addressed via parameters	2
	Counter para.		Counter addressed via parameters	2
AN			AND operation at signal state	
	T f	0 ... 511	Timer	1/2
	C f	0 ... 511	Counter	1/2
	Timer para.		Timer addressed via parameters	2
	Counter para.		Counter addressed via parameters	2

Status word	BR	CC1	CC0	OV	OS	OR	STA	RLO	/FC
Instruction depends on	-	-	-	-	-	✓	-	✓	✓
Instruction influences	-	-	-	-	-	✓	✓	✓	1

Com-mand	Operand	Parameter	Function	Length in words
O			OR operation at signal state	
	T f	0 ... 511	Timer	1/2
	C f	0 ... 511	Counter	1/2
	Timer para.		Timer addressed via parameters	2
	Counter para.		Counter addressed via parameters	2
ON			OR operation at signal state	
	T f	0 ... 511	Timer	1/2
	C f	0 ... 511	Counter	1/2
	Timer para.		Timer addressed via parameters	2
	Counter para.		Counter addressed via parameters	2

Status word	BR	CC1	CC0	OV	OS	OR	STA	RLO	/FC
Instruction depends on	-	-	-	-	-	-	-	✓	✓
Instruction influences	-	-	-	-	-	0	✓	✓	1

Combination instructions (Bit)

Com-mand	Operand	Parameter	Function	Length in words
X			EXCLUSIVE-OR operation at signal state	
	T f	0 ... 511	Timer	1/2
	C f	0 ... 511	Counter	1/2
	Timer para.		Timer addressed via parameters	2
	Counter para.		Counter addressed via parameters	2
XN			EXCLUSIVE-OR operation at signal state	
	T f	0 ... 511	Timer	1/2
	C f	0 ... 511	Counter	1/2
	Timer para.		Timer addressed via parameters	2
	Counter para.		Counter addressed via parameters	2

Status word	BR	CC1	CC0	OV	OS	OR	STA	RLO	/FC
Instruction depends on	-	-	-	-	-	-	-	✓	✓
Instruction influences	-	-	-	-	-	0	✓	✓	1

Combination instructions Examining the specified conditions for their signal status, and gating the result with the RLO according to the appropriate function.

Com-mand	Operand	Parameter	Function	Length in words
A, O, X			AND, OR, EXCLUSIVE OR operation at signal state "1"	
	==0		Result = 0 (CC1=0) and (CC0=0)	1
	>0		Result > 0 (CC1=1) and (CC0=0)	1
	<0		Result < 0 (CC1=0) and (CC0=1)	1
	<>0		Result different to 0 ((CC1=0) and (CC0=1)) or ((CC1=1) and (CC0=0))	1
	>=0		Result < 0 ((CC1=0) and (CC0=1)) or ((CC1=0) and (CC0=0))	1
	>=0		Result >= 0 ((CC1=1) and (CC0=0)) or ((CC1=1) and (CC0=0))	1
	UO		unordered (CC1=1) and (CC0=1)	1
	OS		OS=1	1
	BR		BR=1	1
	OV		OV=1	1

Status word for: A	BR	CC1	CC0	OV	OS	OR	STA	RLO	/FC
Instruction depends on	✓	✓	✓	✓	✓	✓	-	✓	✓
Instruction influences	-	-	-	-	-	✓	✓	✓	1

Status word for: O, X	BR	CC1	CC0	OV	OS	OR	STA	RLO	/FC
Instruction depends on	✓	✓	✓	✓	✓	-	-	✓	✓
Instruction influences	-	-	-	-	-	0	✓	✓	1

Combination instructions (Bit)

Com-mand	Operand	Parameter	Function	Length in words
AN			AND NOT/OR NOT/EXCLUSIVE OR NOT	1
ON			Operation at signal state "0"	
XN	==0		Result = 0 (CC1=0) and (CC0=0)	1
	>0		Result > 0 (CC1=1) and (CC0=0)	1
	<0		Result < 0 (CC1=0) and (CC0=1)	1
	<>0		Result different to 0 ((CC1=0) and (CC0=1)) or ((CC1=1) and (CC0=0))	1
	≤0		Result < 0 ((CC1=0) and (CC0=1)) or ((CC1=0) and (CC0=0))	1
	≥0		Result ≥ 0 ((CC1=1) and (CC0=0)) or ((CC1=1) and (CC0=0))	1
	UO		unordered (CC1=1) and (CC0=1)	1
	OS		OS=0	1
	BR		BR=0	1
OV		OV=0	1	

Status word for: AN	BR	CC1	CC0	OV	OS	OR	STA	RLO	/FC
Instruction depends on	✓	✓	✓	✓	✓	✓	-	✓	✓
Instruction influences	-	-	-	-	-	✓	✓	✓	1

Status word for: ON, XN	BR	CC1	CC0	OV	OS	OR	STA	RLO	/FC
Instruction depends on	✓	✓	✓	✓	✓	-	-	✓	✓
Instruction influences	-	-	-	-	-	-	✓	✓	1

3.19 Combination instructions (Word)

Combination instructions with the contents of ACCU1

Gating the contents of ACCU1 and/or ACCU1-L with a word or double word according to the appropriate function.

The word or double word is either a constant in the instruction or in ACCU2. The result is in ACCU1 and/or ACCU1-L.

Com-mand	Operand	Parameter	Function	Length in words
AW	k16		AND ACCU2-L	1
AW			AND 16bit constant	2
OW	k16		OR ACCU2-L	1
OW			OR 16bit constant	2
XOW	k16		EXCLUSIVE OR ACCU2-L	1
XOW			EXCLUSIVE OR 16bit constant	2
AD	k32		AND ACCU2	1
AD			AND 32bit constant	3
OD	k32		OR ACCU2	1
OD			OR 32bit constant	3
XOD	k32		EXCLUSIVE OR ACCU2	1
XOD			EXCLUSIVE OR 32bit constant	3

Status word	BR	CC1	CC0	OV	OS	OR	STA	RLO	/FC
Instruction depends on	-	-	-	-	-	-	-	-	-
Instruction influences	-	✓	0	0	-	-	-	-	-

3.20 Timer instructions

Starting or resetting a timer (addressed directly or via parameters).

The time value must be in ACCU1-L.

Com-mand	Operand	Parameter	Function	Length in words
SP	T f	0 ... 511	Start time as pulse on edge change from "0" to "1"	1/2
	Timer para.			2
SE	T f	0 ... 511	Start timer as extended pulse on edge change from "0" to "1"	1/2
	Timer para.			2
SD	T f	0 ... 511	Start timer as ON delay on edge change from "0" to "1"	1/2
	Timer para.			2
SS	T f	0 ... 511	Start timer as saving start delay on edge change from "0" to "1"	1/2
	Timer para.			2
SA	T f	0 ... 511	Start timer as OFF delay on edge change from "1" to "0"	1/2
	Timer para.			2
FR	T f	0 ... 511	Enable timer for restarting on edge change from "0" to "1" (reset edge bit memory for starting timer)	1/2
	Timer para.			2
R	T f	0 ... 511	Reset timer	1/2
	Timer para.			2

Status word	BR	CC1	CC0	OV	OS	OR	STA	RLO	/FC
Instruction depends on	-	-	-	-	-	-	-	✓	-
Instruction influences	-	-	-	-	-	0	-	-	0

3.21 Counter instructions

The counter value is in ACCU1-L res. in the address transferred as parameter.

Com-mand	Operand	Parameter	Function	Length in words
S	C f	0 ... 511	Presetting of counter on edge change from "0" to "1"	1/2
	Counter para.			2
R	C f	0 ... 511	Reset counter to "0" on edge change from "0" to "1"	1/2
	Counterpara.			2
CU	C f	0 ... 511	Increment counter by 1 on edge change from "0" to "1"	1/2
	Counterpara.			2
CD	C f	0 ... 511	Decrement counter by 1 on edge change from "0" to "1"	1/2
	Counter para.			2
FR	C f	0 ... 511	Enable counter on edge change from "0" to "1" (reset the edge bit memory for up and down counting)	1/2
	Counter para.			2

Status word	BR	CC1	CC0	OV	OS	OR	STA	RLO	/FC
Instruction depends on	-	-	-	-	-	-	-	✓	-
Instruction influences	-	-	-	-	-	0	-	-	0

4 Block parameters

4.1 HW identifier - HW_ID

HW identifier

- The parameter *HW_ID* to preset the *HW identifier* is only available in S7-1500 CPUs from Siemens.
- When configuring a hardware component, a hardware identifier is automatically assigned as *HW identifier* for each object of the hardware configuration.
- The *HW identifier* is for modules, ports, interfaces and I/O areas of bus systems.
- The *HW identifier* is a decimal integer constant of data type HW_IO.
- The *HW identifier* does not distinguish between input and output ranges.
- You can use the *HW identifier* to address the corresponding hardware components.

Determine *HW identifier*

You can determine the *HW identifier* for the respective component using the following procedure:

1. ➤ Open in the *Project tree* the '*Device configuration*'.
2. ➤ Select the desired hardware component whose *HW identifier* you want to determine.
3. ➤ Click in the *Inspector* window at '*General*'.
 - ⇒ The '*HW identifier*' is shown. These can be used for the parameter *HW_ID* when the blocks are connected.

HW identifier and system constants

You can also determine the *HW identifier* using the '*System constants*'. Via the '*System constants*' in the *Inspector* window all the HW identifiers of an object, which is selected in the device view, are listed with *Name* and *Type*. *Name* and *Type* are automatically generated when assigning the HW identifier. Here *Name* has a hierarchical structure with a maximum of 4 hierarchical levels, with each level separated by a "~". The name of the component of the corresponding hierarchy level can be changed at any time via the properties.

HW identifier in the user program

- When creating your user program, you can assign the corresponding hardware component from a list of all possible hardware components by double-clicking on the corresponding input or output parameter.
- In the case of a hardware interrupt, you can use the start information to determine the *HW identifier* as the '*ID*' of the hardware component that triggers the interrupt.

4.2 General and Specific Error Information RET_VAL

Overview

The return value *RET_VAL* of a system function provides one of the following types of error codes:

- A *general error code*, that relates to errors that can occur in anyone SFC.
- A *specific error code*, that relates only to the particular SFC.

Although the data type of the output parameter *RET_VAL* is integer (INT), the error codes for system functions are grouped according to hexadecimal values.

If you want to examine a return value and compare the value with the error codes, then display the error code in hexadecimal format.

RET_VAL (Return value) The table below shows the structure of a system function error code:

Bit	Description
7 ... 0	Event number or error class and single error
14 ... 8	Bit 14 ... 8 = "0": Specific error code The specific error codes are listed in the descriptions of the individual SFCs. Bit 14 ... 8 > "0": General error code The possible general error codes are shown
15	Bit 15 = "1": indicates that an error has occurred.

Specific error code

This error code indicates that an error pertaining to a particular system function occurred during execution of the function.

A specific error code consists of the following two numbers:

- Error class between 0 and 7
- Error number between 0 and 15

Bit	Description
3 ... 0	Error number
6 ... 4	Error class
7	Bit 7 = "1"
14 ... 8	Bit 14 ... 8 = "0"
15	Bit 15 = "1": indicates that an error has occurred.

General error codes RET_VAL

The parameter *RET_VAL* of some SFCs only returns general error information. No specific error information is available.

The general error code contains error information that can result from any system function. The general error code consists of the following two numbers:

- A parameter number between 1 and 111, where 1 indicates the first parameter of the SFC that was called, 2 the second etc.
- An event number between 0 and 127. The event number indicates that a synchronous fault has occurred.

Bit	Description
7 ... 0	Event number
14 ... 8	Parameter number
15	Bit 15 = "1": indicates that an error has occurred.

General error codes

The following table explains the general error codes associated with a return value. Error codes are shown as hexadecimal numbers. The x in the code number is only used as a placeholder. The number represents the parameter of the system function that has caused the error.

Error code	Description
8x7Fh	Internal Error. This error code indicates an internal error at parameter x. This error did not result from the actions if the user and he/she can therefore not resolve the error.
8x01h	Illegal syntax detection for an ANY parameter.
8x22h	Area size error when a parameter is being read.
8x23h	Area size error when a parameter is being written. This error code indicates that parameter x is located either partially or fully outside of the operand area or that the length of the bit-field for an ANY-parameter is not divisible by 8.
8x24h	Area size error when a parameter is being read.
8x25h	Area size error when a parameter is being written. This error code indicates that parameter x is located in an area that is illegal for the system function. The description of the respective function specifies the areas that are not permitted for the function.
8x26h	The parameter contains a number that is too high for a time cell. This error code indicates that the time cell specified in parameter x does not exist.
8x27h	The parameter contains a number that is too high for a counter cell (numeric fields of the counter). This error code indicates that the counter cell specified in parameter x does not exist.
8x28h	Orientation error when reading a parameter.
8x29h	Orientation error when writing a parameter. This error code indicates that the reference to parameter x consists of an operand with a bit address that is not equal to 0.
8x30h	The parameter is located in the write-protected global-DB.
8x31h	The parameter is located in the write-protected instance-DB. This error code indicates that parameter x is located in a write-protected data block. If the data block was opened by the system function itself, then the system function will always return a value 8x30h.
8x32h	The parameter contains a DB-number that is too high (number error of the DB).
8x34h	The parameter contains a FC-number that is too high (number error of the FC).
8x35h	The parameter contains a FB-number that is too high (number error of the FB). This error code indicates that parameter x contains a block number that exceeds the maximum number permitted for block numbers.
8x3Ah	The parameter contains the number of a DB that was not loaded.
8x3Ch	The parameter contains the number of a FC that was not loaded.
8x3Eh	The parameter contains the number of a FB that was not loaded.
8x42h	An access error occurred while the system was busy reading a parameter from the peripheral area of the inputs.
8x43h	An access error occurred while the system was busy writing a parameter into den peripheral area of the outputs.
8x44h	Error during the n-th ($n > 1$) read access after an error has occurred.
8x45h	Error during the n-th ($n > 1$) write access after an error has occurred. This error code indicates that access was denied to the requested parameter.

5 Include VIPA library

Libraries

The VIPA specific blocks can be found as library ‘...LIB’ for download in the service area of www.vipa.com at ‘Downloads’. The libraries are packed ZIP files. As soon as you want to use VIPA specific blocks you have to import them into your project. The VIPA specific blocks can be found in the libraries according to its applications:

- General functions
 - ↪ *Chap. 7 ‘Building Control’ page 102*
 - ↪ *Chap. 8 ‘Network Communication’ page 114*
 - ↪ *Chap. 10 ‘Serial Communication’ page 203*
 - ↪ *Chap. 11 ‘EtherCAT Communication’ page 238*
 - ↪ *Chap. 15 ‘Standard’ page 795*
 - ↪ *Chap. 16 ‘System Blocks’ page 883*
- Simple Motion Control
 - ↪ *Chap. 13 ‘Motion control - Simple Motion Control Library’ page 287*
- Modbus
 - ↪ *Chap. 9 ‘Modbus Communication’ page 183*
- Energy and frequency measurement

This library is only available for the Siemens SIMATIC Manager.

 - ↪ *Chap. 12 ‘Device Specific’ page 246*

5.1 Integration into Siemens SIMATIC Manager

Overview

The integration into the Siemens SIMATIC Manager requires the following steps:

1. ➤ Load ZIP file
2. ➤ "Retrieve" the library
3. ➤ Open library and transfer blocks into the project

Load ZIP file

➤ Navigate on the web page to the desired ZIP file, load and store it in your work directory.

Retrieve library

1. ➤ Start the Siemens SIMATIC Manager with your project.
2. ➤ Open the dialog window for ZIP file selection via ‘File ➔ Retrieve’.
3. ➤ Select the according ZIP file and click at [Open].
4. ➤ Select a destination folder where the blocks are to be stored.
5. ➤ Start the extraction with [OK].

Open library and transfer blocks into the project

1. ➤ Open the library after the extraction.
2. ➤ Open your project and copy the necessary blocks from the library into the directory "blocks" of your project.
 - ⇒ Now you have access to the VIPA specific blocks via your user application.



Are FCs used instead of SFCs, so they are supported by the VIPA CPUs starting from firmware 3.6.0.

5.2 Integration into Siemens TIA Portal

Overview

The integration into the Siemens TIA Portal requires the following steps:

1. Load ZIP file
2. Unzip the Zip file
3. Open library and transfer blocks into the project

Load ZIP file

1. Navigate on the web page to the ZIP file, that matches your version of the program.
2. Load and store it in your work directory.

Unzip the Zip file

- Unzip the zip file to a work directory of the Siemens TIA Portal with your unzip application.

Open library and transfer blocks into the project

1. Start the Siemens TIA Portal with your project.
2. Switch to the *Project view*.
3. Choose "Libraries" from the task cards on the right side.
4. Click at "Global libraries".
5. Click at "Open global libraries".
6. Navigate to your work directory and load the file ..._TIA.al1x.

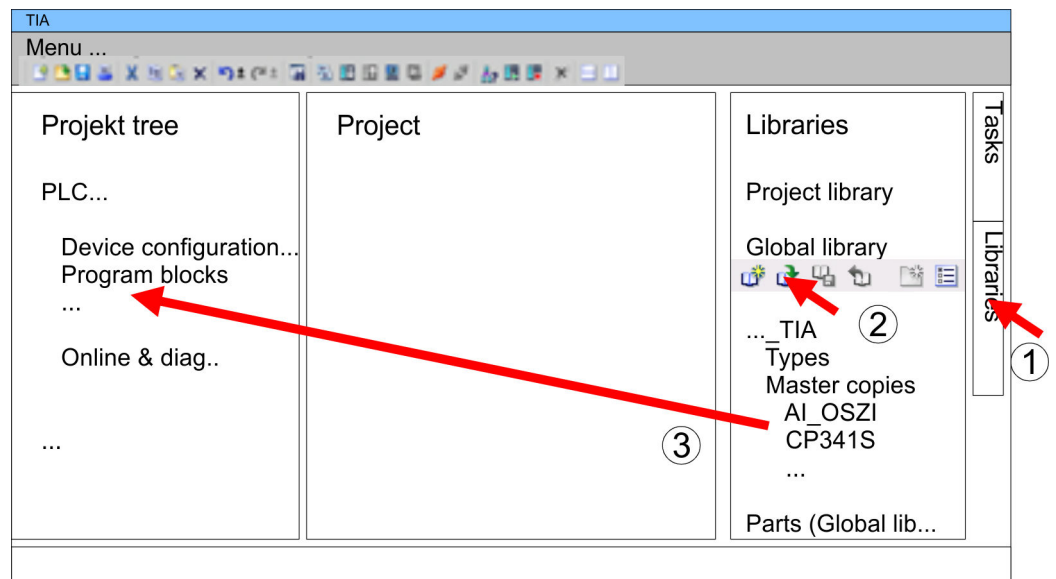

7. Copy the necessary blocks from the library into the "Program blocks" of the *Project tree* of your project. Now you have access to the VIPA specific blocks via your user application.

6 Organization Blocks

6.1 Overview

OBs (Organization blocks) are the interface between the operating system of the CPU and the user program. For the main program OB 1 is used. There are reserved numbers corresponding to the call event of the other OBs. Organization blocks are executed corresponding to their priority. OBs are used to execute specific program sections:

- On start-up of the CPU
- On cyclic or clocked execution
- On errors
- On hardware interrupts occur

6.2 Main

6.2.1 OB1 - Main - Program Cycle

Description	The operating system of the CPU executes OB 1 cyclically. After STARTUP to RUN the cyclical processing of the OB 1 is started. OB 1 has the lowest priority (priority 1) of each cycle time monitored OB. Within the OB 1 functions and function blocks can be called.
Function	When OB 1 has been executed, the operating system sends global data. Before restarting OB 1, the operating system writes the process-image output table to the output modules, updates the process-image input table and receives any global data for the CPU.
Cycle time	<p>Cycle time is the time required for processing the OB 1. It also includes the scan time for higher priority classes which interrupt the main program respectively communication processes of the operating system. This comprises system control of the cyclic program scanning, process image update and refresh of the time functions.</p> <p>By means of the Siemens SIMATIC manager the recent cycle time of an online connected CPU may be shown. With PLC > Module Information > Scan cycle time the min., max. and recent cycle time can be displayed.</p>
Scan cycle monitoring time	The CPU offers a scan cycle watchdog for the max. <i>cycle time</i> . The default value for the max. <i>cycle time</i> is 150ms as <i>scan cycle monitoring time</i> . This value can be reconfigured or restarted by means of the SFC 43 (RE_TRIGR) at every position of your program. If the main program takes longer to scan than the specified scan cycle monitoring time, the OB 80 (Timeout) is called by the CPU. If OB 80 has not been programmed, the CPU goes to STOP. Besides the monitoring of the <i>max. cycle time</i> the observance of the <i>min cycle time</i> can be guaranteed. Here the restart of a new cycle (writing of process image of the outputs) is delayed by the CPU as long as the <i>min. cycle time</i> is reached.
Access to local data	The CPU's operating system forwards start information to OB 1, as it does to every OB, in the first 20 bytes of temporary local data. The start information can be accessed by means of the system function SFC 6 RD_SINFO. Note that direct reading of the start information for an OB is possible only in that OB because that information consists of temporary local data.
Local data	The following table describes the start information of the OB 1 with default names of the variables and its data types:

Startup > OB 100, OB 102 - Complete/Cold Restart - Startup

Variable	Type	Description
OB1_EV_CLASS	BYTE	Event class and identifiers: 11h: OB 1 active
OB1_SCAN_1	BYTE	01h: completion of a restart 03h: completion of the main cycle
OB1_PRIORITY	BYTE	Priority class: 1
OB1_OB_NUMBR	BYTE	OB number (01)
OB1_RESERVED_1	BYTE	reserved
OB1_RESERVED_2	BYTE	reserved
OB1_PREV_CYCLE	INT	Run time of previous cycle (ms)
OB1_MIN_CYCLE	INT	Minimum cycle time (ms) since the last startup
OB1_MAX_CYCLE	INT	Maximum cycle time (ms) since the last startup
OB1_DATE_TIME	DATE_AND_TIME	Date and time of day when the OB was called

6.3 Startup

6.3.1 OB 100, OB 102 - Complete/Cold Restart - Startup

Description

On a restart, the CPU sets both itself and the modules to the programmed initial state, deletes all not-latching data in the system memory, calls Startup OB and then executes the main program in OB 1. Here the current program and the current data blocks generated by SFC remain in memory.

A distinction is made between the following types of startup:

- OB 100: Complete restart
- OB 102: Cold restart

The CPU executes a startup as follows:

- after PowerON and operating switch in RUN
- whenever you switch the mode selector from STOP to RUN
- after a request using a communication function
(menu command from the programming device)

Even if no startup OB is loaded into the CPU, the CPU goes to RUN without an error message.

Local data

The following table describes the start information of the startup OB with default names of the variables and its data types:

Variable	Type	Description
OB10x_EV_CLASS	BYTE	Event class and identifiers: 13h: active
OB10x_STRTUP	BYTE	Startup request <ul style="list-style-type: none"> ■ 81h: Manual restart request ■ 82h: Automatic restart request ■ 85h: Request for manual cold restart ■ 86h: Request for automatic cold restart ■ 8Ah: Master: Manual restart request ■ 8Bh: Master: Automatic restart request
OB10x_PRIORITY	BYTE	Priority class: 27
OB10x_OB_NUMBR	BYTE	OB number (100 or 102)
OB10x_RESERVED_1	BYTE	reserved
OB10x_RESERVED_2	BYTE	reserved
OB10x_STOP	WORD	Number of the event that caused the CPU to STOP
OB10x_STRT_INFO	DWORD	Supplementary information about the current startup
OB10x_DATE_TIME	DATE_AND_TIME	Date and time of day when the OB was called

Information to access the local data can be found at the description of the OB 1.

Allocation

OB10x_STRT_INFO

Bit no.	Explanation	Possible values (binary)	Description
31...24	Startup information	xxxx xxx0	No difference between expected and actual configuration
		xxxx xxx1	Difference between expected and actual configuration
		xxxx 0xxx	Clock for time stamp not battery-backed at last PowerON
		xxxx 1xxx	Clock for time stamp battery-backed at last PowerON
23...16	Startup just completed	0000 0011	Restart triggered with mode selector
		0000 0100	Restart triggered by command via MPI
		0000 0111	Cold restart triggered with mode selector
		0000 1000	Cold restart triggered by command via MPI
		0001 0000	Automatic restart after battery-backed PowerON
		0001 0011	Restart triggered with mode selector; last PowerON battery-backed
		0001 0100	Restart triggered by command via MPI; last PowerON battery-backed
		0010 0000	Automatic restart battery-backed PowerON (with memory reset by system)
		0010 0011	Restart triggered with mode selector last PowerON not battery-backed
		0010 0100	Restart triggered by command via MPI last PowerON not battery-backed
15...12	Permissibility of automatic startup	0000	Automatic startup illegal, memory request requested

Bit no.	Explanation	Possible values (binary)	Description
		0001	Automatic startup illegal, parameter modifications, etc. necessary
		0111	Automatic startup permitted
11...8	Permissibility of manual startup	0000	Manual startup illegal, memory request requested
		0001	Manual startup illegal, parameter modifications, etc. necessary
		0111	Manual startup permitted
7...0	Last valid intervention or setting of the automatic startup at PowerON	0000 0000	No startup
		0000 0011	Restart triggered with mode selector
		0000 0100	Restart triggered by command via MPI
		0001 0000	Automatic restart after battery-backed PowerON
		0001 0011	Restart triggered with mode selector; last PowerON battery-backed
		0001 0100	Restart triggered by command via MPI; last PowerON battery-backed
		0010 0000	Automatic restart after battery-backed PowerON (with memory reset by system)
		0010 0011	Restart triggered with mode selector last PowerON not battery-backed
		0010 0100	Restart triggered by command via MPI last PowerON not battery-backed

6.4 Communication Interrupts

6.4.1 OB 55 - DP: Status Alarm - Status Interrupt

Description



A status interrupt OB (OB 55) is only available for DP-V1 capable CPUs.

The CPU operating system calls OB 55 if a status interrupt was triggered via the slot of a DP-V1 slave. This might be the case if a component (module) of a DP-V1 slaves changes its operating mode, for example from RUN to STOP. For precise information on events that trigger a status interrupt, refer to the documentation of the DP-V1 slave's manufacturer.

Local data

The following table describes the start information of the OB 55 with default names of the variables and its data types:

Variable	Data type	Description
OB55_EV_CLASS	BYTE	Event class and identifiers: 11h: incoming event
OB55_STRT_INF	BYTE	55h: Status interrupt for DP 58h: Status interrupt for PROFINET IO

Variable	Data type	Description
OB55_PRIORITY	BYTE	Configured priority class: Default value: 2
OB55_OB_NUMBR	BYTE	OB number (55)
OB55_RESERVED_1	BYTE	reserved
OB55_IO_FLAG	BYTE	Input module: 54h Output module: 55h
OB55_MDL_ADDR	WORD	Logical base address of the module that triggers the interrupt
OB55_LEN	BYTE	Data block length supplied by the interrupt
OB55_TYPE	BYTE	ID for the interrupt type "Status interrupt"
OB55_SLOT	BYTE	Slot number of the interrupt triggering component (module)
OB55_SPEC	BYTE	Specifier: <ul style="list-style-type: none"> ■ Bit 1, 0: Interrupt specifier ■ Bit 2: Add_Ack ■ Bit 7 ... 3: Seq. number
OB55_DATE_TIME	DATE_AND_TIME	Date and time of day when the OB was called



You can obtain the full additional information on the interrupt from the frame by calling SFB 54 "RALRM" in OB 55. ↗ Chap. 14.2.22 'SFB 54 - RALRM - Receiving an interrupt from a periphery module' page 777

6.4.2 OB 56 - DP: Update Alarm - Update Interrupt

Description



A update interrupt OB (OB 56) is only available for DP-V1 capable CPUs.

The CPU operating system calls OB 56 if an update interrupt was triggered via the slot of a DP-V1 slave. This can be the case if you have changed the parameters for the slot of a DP-V1 slave. For precise information on events that trigger an update interrupt, refer to the documentation of the DP-V1 slave manufacturer.

Local data

The following table describes the start information of the OB 56 with default names of the variables and its data types:

Variable	Data type	Description
OB56_EV_CLASS	BYTE	Event class and identifiers: 11h: incoming event
OB56_STRT_INF	BYTE	56h: Update interrupt for DP 59h: Update interrupt for PROFINET IO

Variable	Data type	Description
OB56_PRIORITY	BYTE	Configured priority class: Default value: 2
OB56_OB_NUMBR	BYTE	OB number (56)
OB56_RESERVED_1	BYTE	reserved
OB56_IO_FLAG	BYTE	Input module: 54h Output module: 55h
OB56_MDL_ADDR	WORD	Logical base address of the module that triggers the interrupt
OB56_LEN	BYTE	Data block length supplied by the interrupt
OB56_TYPE	BYTE	ID for the interrupt type "Update interrupt"
OB56_SLOT	BYTE	Slot number of the interrupt triggering component
OB56_SPEC	BYTE	Specifier: <ul style="list-style-type: none"> ■ Bit 1, 0: Interrupt specifier ■ Bit 2: Add_Ack ■ Bit 7 ... 3: Seq. number
OB56_DATE_TIME	DATE_AND_TIME	Date and time of day when the OB was called



You can obtain the full additional information on the interrupt from the frame by calling SFB 54 "RALRM" in OB 56. ↪ Chap. 14.2.22 'SFB 54 - RALRM - Receiving an interrupt from a periphery module' page 777

6.4.3 OB 57 - DP: Manufacture Alarm - Manufacturer Specific Interrupt

Description

The OB 57 is called by the operating system of the CPU if an manufacturer specific interrupt was triggered via the slot of a slave system.

Local data

The following table describes the start information of the OB 57 with default names of the variables and its data types:

Variable	Data type	Description
OB57_EV_CLASS	BYTE	Event class and identifiers: 11h: incoming event
OB57_STRT_INF	BYTE	57h: Start request for OB 57
OB57_PRIORITY	BYTE	Configured priority class: Default value: 2
OB57_OB_NUMBR	BYTE	OB number (57)
OB57_RESERVED_1	BYTE	reserved
OB57_IO_FLAG	BYTE	Input module: 54h Output module: 55h
OB57_MDL_ADDR	WORD	Logical base address of the module that triggers the interrupt
OB57_LEN	BYTE	reserved
OB57_TYPE	BYTE	reserved
OB57_SLOT	BYTE	reserved
OB57_SPEC	BYTE	reserved
OB57_DATE_TIME	DATE_AND_TIME	Date and time of day when the OB was called



You can obtain the full additional information on the interrupt from the frame by calling SFB 54 "RALRM" in OB 57.

6.5 Time delay Interrupts

6.5.1 OB 20, OB 21 - DEL_INTx - Time-delay Interrupt

Description

A time-delay interrupt allows you to implement a delay timer independently of the standard timers. The time-delay interrupts can be configured within the hardware configuration respectively controlled by means of system functions in your main program at run time.

Activation

For the activation no hardware configuration is necessary. The time-delay interrupt is started by calling SFC 32 SRT_DINT and by transferring the corresponding OB to the CPU. Here the function needs OB number, delay time and a sign. When the delay interval has expired, the respective OB is called by the operating system. The time-delay interrupt that is just not activated can be cancelled with SFC 33 CAN_DINT respectively by means of the SFC 34 QRY_DINT the status can be queried. It can be blocked with SFC 39 DIS_IRT and released with SFC 40 EN_IRT. The priority of the corresponding OBs are changed via the hardware configuration. For this open the selected CPU with **Edit** > *Object properties* > *Interrupts*. Here the corresponding priority can be adjusted.

Behavior on error If a time-delay interrupt OB is called but was not programmed, the operating system calls OB 85. If OB 85 was not programmed, the CPU goes to STOP.

Local data The following table describes the start information of the OB 20 and OB 21 with default names of the variables and its data types:

Variable	Type	Description
OB20_EV_CLASS	BYTE	Event class and identifiers: 11h: interrupt is active
OB20_STRT_INF	BYTE	21h: start request for OB 20 22h: start request for OB 21
OB20_PRIORITY	BYTE	assigned priority class: Default: 3 (OB 20) ... 6 (OB 23)
OB20_OB_NUMBR	BYTE	OB number (20, 21)
OB20_RESERVED_1	BYTE	reserved
OB20_RESERVED_2	BYTE	reserved
OB20_SIGN	WORD	User ID: input parameter SIGN from the call for SFC 32 (SRT_DINT)
OB20_DTIME	TIME	Configured delay time in ms
OB20_DATE_TIME	DATE_AND_TIME	Date and time of day when the OB was called

Information to access the local data can be found at the description of the OB 1.

6.6 Time of day Interrupts

6.6.1 OB 10, OB 11 - TOD_INTx - Time-of-day Interrupt

Description Time-of-day interrupts are used when you want to run a program at a particular time, either once only or periodically. Time-of-day interrupts can be configured within the hardware configuration or controlled by means of system functions in your main program at run time. The prerequisite for proper handling of time-of-day interrupts is a correctly set real-time clock on the CPU. For execution there are the following intervals:

- once
- every minute
- hourly
- daily
- weekly
- monthly
- once at year
- at the end of each month



For monthly execution of a time-of-day interrupt OBs, only the day 1, 2, ... 28 can be used as a starting date.

Function

To start a time-of-day interrupt, you must first set and then activate the interrupt. The three following start possibilities exist:

1. ➤ The time-of-day interrupts are configured via the hardware configuration. Open the selected CPU with **Edit** > *Object properties* > *Time-of-Day interrupts*. Here the corresponding time-of-day interrupts may be adjusted and activated. After transmission to CPU and startup the monitoring of time-of-day interrupt is automatically started.
2. ➤ Set the time-of-day interrupt within the hardware configuration as shown above and then activate it by calling SFC 30 ACT_TINT in your program.
3. ➤ You set the time-of-day interrupt by calling SFC 28 SET_TINT and then activate it by calling SFC 30 ACT_TINT.

The time-of-day interrupt can be delayed and enabled with the system functions SFC 41 DIS_AIRT and SFC 42 EN_AIRT.

Behavior on error

If a time-of-day interrupt OB is called but was not programmed, the operating system calls OB 85. If OB 85 was not programmed, the CPU goes to STOP. Is there an error at time-of-day interrupt processing e.g. start time has already passed, the time error OB 80 is called. The time-of-day interrupt OB is then executed precisely once.

Possibilities of activation

The possibilities of activation of time-of-day interrupts is shown at the following table:

Interval	Description
Not activated	The time-of-day interrupt is not executed, even when loaded in the CPU. It may be activated by calling SFC 30.
Activated once only	The time-of-day OB is cancelled automatically after it runs the one time specified. Your program can use SFC 28 and SFC 30 to reset and reactivate the OB.
Activated periodically	When the time-of-day interrupt occurs, the CPU calculates the next start time for the time-of-day interrupt based on the current time of day and the period.

Local data for time-of-day interrupt OB

The following table describes the start information of the OB 10 ... OB 11 with default names of the variables and its data types. The variable names are the default names of OB 10.

Variable	Type	Description
OB10_EV_CLASS	BYTE	Event class and identifiers: 11h: interrupt is active
OB10_STRT_INFO	BYTE	11h: Start request for OB 10 12h: Start request for OB 11
OB10_PRIORITY	BYTE	Assigned priority class: default 2
OB10_OB_NUMBR	BYTE	OB number (10 ... 11)
OB10_RESERVED_1	BYTE	reserved
OB10_RESERVED_2	BYTE	reserved
OB10_PERIOD_EXE	WORD	The OB is executed at the specified intervals: 0000h: once 0201h: once every minute 0401h: once hourly 1001h: once daily 1201h: once weekly 1401h: once monthly 1801h: once yearly 2001h: end of month
OB10_RESERVED_3	INT	reserved
OB10_RESERVED_4	INT	reserved
OB10_DATE_TIME	DATE_AND_TIME	Date and time of day when the OB was called

Information to access the local data can be found at the description of the OB 1.

6.7 Cyclic Interrupts

6.7.1 OB 28, 29, 32, 33, 34, 35 - CYC_INTx - Cyclic Interrupt

Description

By means of a cyclic interrupt the cyclical processing can be interrupted in equidistant time intervals. The start time of the time interval and the phase offset is the instant of transition from STARTUP to RUN after execution of OB 100.

Watchdog OB	Default time interval	Default priority class	Option for phase offset
OB 28	250µs	24	no*
OB 29	500µs	24	no*
OB 32	1s	09	yes
OB 33	500ms	10	yes
OB 34	200ms	11	yes
OB 35	100ms	12	yes

*) If both OBs are activated OB 28 is executed first and then OB 29. Due to the very short time intervals and the high priority a simultaneous execution of OB 28 and OB 29 should be avoided.

Activation A cyclic interrupt is activated by programming the corresponding OB within the CPU. The cyclic interrupt can be delayed and enabled with the system functions SFC 41 DIS_AIRT and SFC 42 EN_AIRT.

Function After startup to RUN the activated cyclic OBs are called in the configured equidistant intervals with consideration of the phase shift. The equidistant start times of the cyclic OBs result of the respective time frame and the phase shift. So a sub program can be called time controlled by programming a respective OB.

Phase offset The phase offset can be used to stagger the execution of cyclic interrupt handling routines despite the fact that these routines are timed to a multiple of the same interval. The use of the phase offset achieves a higher interval accuracy. The start time of the time interval and the phase offset is the instant of transition from STARTUP to RUN. The call instant for a cyclic interrupt OB is thus the time interval plus the phase offset.

Parameterization Time interval, phase offset (not OB 28, 29) and priority may be parameterized by the hardware configurator.

Depending on the OB there are the following possibilities for parameterization:

OB 28, 29, 33:	Parameterizable as VIPA specific parameter by the properties of the CPU.
OB 32, 35:	Parameterizable by Siemens CPU 318-2DP.



You must make sure that the run time of each cyclic interrupt OB is significantly shorter than its interval. The cyclic interrupt that caused the error is executed later.

Local data The following table describes the start information with default names of the variables and its data types. The variable names are the default names of OB 35.

Variable	Type	Description
OB35_EV_CLASS	BYTE	Event class and identifiers: 11h: Cyclic interrupt is active
OB35_STRT_INF	BYTE	2Fh: Start request for OB 28 30h: Start request for OB 29 33h: Start request for OB 32 34h: Start request for OB 33 35h: Start request for OB 34 36h: Start request for OB 35
OB35_PRIORITY	BYTE	Assigned priority class; Default values: 24 (OB 28, 29), 9 (OB 32) ... 12 (OB 35)

Variable	Type	Description
OB35_OB_NUMBR	BYTE	OB number (28, 29, 32 ... 35)
OB35_RESERVED_1	BYTE	reserved
OB35_RESERVED_2	BYTE	reserved
OB35_PHASE_OFFSET	WORD	Phase offset in ms
OB35_RESERVED_3	INT	reserved
OB35_EXC_FREQ	INT	Interval in ms
OB35_DATE_TIME	DATE_AND_TIME	Date and time of day when the OB was called

Information to access the local data can be found at the description of the OB 1.



Since the blocks SFC58/59 respectively SFB52/53 for reading and writing data blocks cannot be interrupted, in conjunction with OB 28 and OB 29 the CPU may change to STOP state!

6.8 Hardware Interrupts

6.8.1 OB 40, OB 41 - HW_INTx - Hardware Interrupt

Description

Hardware interrupts are used to enable the immediate detection in the user program of events in the controlled process, making it possible to respond with an appropriate interrupt handling routine. Here OB 40 and OB 41 can be used. Within the configuration you specify for each module, which channels release a hardware interrupt during which conditions. With the system functions SFC 55 WR_PARM, SFC 56 WR_DPARM and SFC 57 PARM_MOD you can (re)parameterize the modules with hardware interrupt capability even in RUN. ↪ Chap. 14.1.43 'SFC 55 - WR_PARM - Write dynamic parameter' page 692 ↪ Chap. 14.1.44 'SFC 56 - WR_DPARM - Write default parameter' page 694 ↪ Chap. 14.1.45 'SFC 57 - PARM_MOD - Parameterize module' page 696

Activation

The hardware interrupt processing of the CPU is always active. So that a module can release a hardware interrupt, you have to activate the hardware interrupt on the appropriate module by a hardware configuration. Here you can specify whether the hardware interrupt should be generated for a coming event, a leaving event or both.

Function

After a hardware interrupt has been triggered by the module, the operating system identifies the slot and the corresponding hardware interrupt OB. If this OB has a higher priority than the currently active priority class, it will be started. The channel-specific acknowledgement is sent after this hardware interrupt OB has been executed. If another event that triggers a hardware interrupt occurs on the same module during the time between identification and acknowledgement of a hardware interrupt, the following applies:

- If the event occurs on the channel that previously triggered the hardware interrupt, then the new interrupt is lost.
- If the event occurs on another channel of the same module, then no hardware interrupt can currently be triggered. This interrupt, however, is not lost, but is triggered if just active after the acknowledgement of the currently active hardware interrupt. Else it is lost.
- If a hardware interrupt is triggered and its OB is currently active due to a hardware interrupt from another module, the new request can be processed only if it is still active after acknowledgement.

During STARTUP there is no hardware interrupt produced. The treatment of interrupts starts with the transition to operating mode RUN. Hardware interrupts during transition to RUN are lost.

Behavior on error

If a hardware interrupt is generated for which there is no hardware interrupt OB in the user program, OB 85 is called by the operating system. The hardware interrupt is acknowledged. If OB 85 has not been programmed, the CPU goes to STOP

Diagnostic interrupt

While the treatment of a hardware interrupt a diagnostic interrupt can be released. Is there, during the time of releasing the hardware interrupt up to its acknowledgement, on the same channel a further hardware interrupt, the loss of the hardware interrupt is announced by means of a diagnostic interrupt for system diagnostics.

Local data

The following table describes the start information of the OB 40 and OB 41 with default names of the variables and its data types:

Variable	Type	Description
OB40_EV_CLASS	BYTE	Event class and identifiers: 11h: Interrupt is active
OB40_STRT_INF	BYTE	41h: Interrupt via Interrupt line 1
OB40_PRIORITY	BYTE	Assigned priority class: Default: 16 (OB 40) Default: 17 (OB 41)
OB40_OB_NUMBR	BYTE	OB number (40, 41)
OB40_RESERVED_1	BYTE	reserved
OB40_IO_FLAG	BYTE	Input Module: 54h Output Module: 55h
OB40_MDL_ADDR	WORD	Logical base address of the module that triggers the interrupt
OB40_POINT_ADDR	DWORD	<ul style="list-style-type: none"> ■ For digital modules <ul style="list-style-type: none"> – Bit field with the states of the inputs on the module (bit 0 corresponds to the first input). ■ For analog modules <ul style="list-style-type: none"> – Bit field with information which channel has exceeded which limit. ■ For CPs or IMs <ul style="list-style-type: none"> – Informs about the module interrupt status.
OB40_DATE_TIME	DATE_AND_TIME	Date and time of day when the OB was called

Information to access the local data can be found at the description of the OB 1.

6.9 Asynchronous error Interrupts

6.9.1 OB 80 - CYCL_FLT - Time Error

Description

The operating system of the CPU calls OB 80 whenever an error occurs like:

- Cycle monitoring time exceeded
- OB request error i.e. the requested OB is still executed or an OB was requested too frequently within a given priority class.
- Time-of-day interrupt error i.e. interrupt time past because clock was set forward or after transition to RUN.

The time error OB can be blocked, respectively delayed and released by means of SFC 39 ... 42.



If OB 80 has not been programmed, the CPU changes to the STOP mode. If OB 80 is called twice during the same scan cycle due to the scan time being exceeded, the CPU changes to the STOP mode. You can prevent this by calling SFC 43 RE_TRIGR at a suitable point in the program.

Local data

The following table describes the start information of the OB 80 with default names of the variables and its data types:

Variable	Type	Description
OB80_EV_CLASS	BYTE	Event class and identifiers: 35h
OB80_FLT_ID	BYTE	Error code (possible values: 01h, 02h, 05h, 06h, 07h, 08h, 09h, 0Ah)
OB80_PRIORITY	BYTE	Priority class: 26 (RUN mode) 28 (Overflow of the OB request buffer)
OB80_OB_NUMBR	BYTE	OB number (80)
OB80_RESERVED_1	BYTE	reserved
OB80_RESERVED_2	BYTE	reserved
OB80_ERROR_INFO	WORD	Error information: depending on error code
OB80_ERR_EV_CLASS	BYTE	Event class for the start event that caused the error
OB80_ERR_EV_NUM	BYTE	Event number for the start event that caused the error
OB80_OB_PRIORITY	BYTE	Error information: depending on error code
OB80_OB_NUM	BYTE	Error information: depending on error code
OB80_DATE_TIME	DATE_AND_TIME	Date and time of day when the OB was called

Information to access the local data can be found at the description of the OB 1.

Variables depending on error code

The variables dependent on the error code have the following allocation:

Error code	Variable	Bit	Description
01h			<i>Cycle time exceeded</i>
	OB80_ERROR_INFO		Run time of last scan cycle (ms)
	OB80_ERR_EV_CLASS		Class of the event that triggered the interrupt
	OB80_ERR_EV_NUM		Number of the event that triggered the interrupt
	OB80_OB_PRIORITY		Priority class of the OB which was being executed when the error occurred
	OB80_OB_NUM		Number of the OB which was being executed when the error occurred
02h			<i>The called OB is still being executed</i>
	OB80_ERROR_INFO		The respective temporary variable of the called block which is determined by OB80_ERR_EV_CLASS and OB80_ERR_EV_NUM
	OB80_ERR_EV_CLASS		Class of the event that triggered the interrupt
	OB80_ERR_EV_NUM		Number of the event that triggered the interrupt

Error code	Variable	Bit	Description
	OB80_OB_PRIORITY		Priority class of the OB causing the error
	OB80_OB_NUM		Number of the OB causing the error
05h and 06h			<i>Elapsed time-of-day interrupt due to moving the clock forward</i>
			Elapsed time-of-day interrupt on return to RUN after HOLD
	OB80_ERROR_INFO	Bit 0 = "1"	The start time for time-of-day interrupt 0 is in the past
	
		Bit 7 = "1"	The start time for time-of-day interrupt 7 is in the past
		Bit 15 ... 8	Not used
	OB80_ERR_EV_CLASS		Not used
	OB80_ERR_EV_NUM		Not used
OB80_OB_PRIORITY		Not used	
OB80_OB_NUM		Not used	
07h	meaning of the parameters see error code 02h		<p><i>Overflow of OB request buffer for the current priority class</i></p> <p>(Each OB start request for a priority class will be entered in the corresponding OB request buffer; after completion of the OB the entry will be deleted. If there are more OB start requests for a priority class than the maximum permitted number of entries in the corresponding Ob request buffer OB 80 will be called with error code 07h)</p>
08h			<i>Synchronous-cycle interrupt time error</i>
09h			<i>Interrupt loss due to high interrupt load</i>
0Ah	OB80_ERROR_INFO		<i>Resume RUN after CiR (Configuration in RUN) CiR synchronizations time in ms</i>

6.9.2 OB 81 - PS_FLT - Power Supply Error

Description

The operating system of the CPU calls OB 81 whenever an event occurs that is triggered by an error or fault related to the power supply (when entering and when outgoing event).

The CPU does not change to the STOP mode if OB 81 is not programmed.

You can disable or delay and re-enable the power supply error OB using SFCs 39 ... 42.

Local Data

The following table describes the start information of the OB 81 with default names of the variables and its data types:

Variable	Data type	Description
OB81_EV_CLASS	BYTE	Event class and identifiers: 39h: incoming event
OB81_FLT_ID	BYTE	Error code: 22h: Back-up voltage missing
OB81_PRIORITY	BYTE	Priority class: 28 (mode STARTUP)
OB81_OB_NUMBR	BYTE	OB-NR. (81)
OB81_RESERVED_1	BYTE	reserved
OB81_RESERVED_2	BYTE	reserved
OB81_RACK_CPU	WORD	Bit 2 ... 0: 000 (Rack number) Bit 3: 1 (master CPU) Bit 7 ... 4: 1111 (fix)
OB81_RESERVED_3	BYTE	reserved
OB81_RESERVED_4	BYTE	reserved
OB81_RESERVED_5	BYTE	reserved
OB81_RESERVED_6	BYTE	reserved
OB81_DATE_TIME	DATE_AND_TIME	Date and time of day when the OB was called

Information to access the local data can be found at the description of the OB 1.

6.9.3 OB 82 - I/O_FLT1 - Diagnostic Interrupt

Description

- The system diagnostic is the detection, evaluation and reporting of messages which occur within a PLC system. Examples of errors for these messages could be errors in the user program, module failures or wire breaks on signalling modules.
- If a module with diagnostic capability for which you have enabled the diagnostic interrupt detects an error, it outputs a request for a diagnostic interrupt to the CPU on income and outgoing event. The operating system then calls OB 82.
- The local variables of OB 82 contain the logical base address as well as four bytes of diagnostic data of the faulty module.
- If OB 82 has not been programmed, the CPU changes to the STOP mode. You can delay the diagnostic interrupt OB with SFC 41 DIS_AIRT or disable the delay with SFC 42 EN_AIRT.

Diagnostic in ring buffer

All diagnostic events reported to the CPU operating system are entered in the diagnostic buffer in the order in which they occurred, and with date and time stamp. This is a buffered memory area on the CPU that retains its contents even in the event of an overall reset.

- This diagnostic buffer is a ring buffer and offers at the CPUs of VIPA space for 100 entries.
- When the diagnostic buffer is full, the oldest entry is overwritten by the newest.
- If you are online with the CPU, you can read out the diagnostic buffer by means of the PLC functions of the Siemens SIMATIC Manager. Besides of the standard entries in the diagnostics buffer, the VIPA CPUs support some additional specific entries as event-IDs. More information may be found in the manual of the CPU at "Deployment of the CPU ..." at "Diagnostic entries".

Configurable Diagnostics With programmable diagnostic events a message only occurs if you have enabled diagnostic by parameter assignment. Non-programmable diagnostic events are always reported, regardless of whether or not diagnostic has been enabled.

Write diagnostic data with SFC A diagnostic entry can be written to the diagnostic buffer by means of the system function SFC 52 WR_USMSG.

Read diagnostic data with SFC 59 You can use the SFC 59 RD_REC (read record set) in OB 82 to obtain detailed error information. The diagnostic data are consistent until OB 82 is exited. Exiting of OB 82 acknowledges the diagnostic interrupt. The module's diagnostic data are in record set 0 (DS 0) and record set 1 (DS 1). DS 0 contains 4byte, which describe the current status of the module. The contents of these bytes are identical to the contents of byte 8 ... 11 of the start information of OB 82. DS 1 contains the 4 byte of DS 0 and, in addition, the module specific diagnostic data. More information about module specific diagnostic data can be found at the description of the appropriate module.

Local data Information to access the local data can be found at the description of the OB 1. The following table describes the start information of the OB 82 with default names of the variables and its data types:

Variable	Data type	Description
OB82_EV_CLASS	BYTE	Event class and identifiers: 38h: outgoing event 39h: incoming event
OB82_FLT_ID	BYTE	Error code (42h)
OB82_PRIORITY	BYTE	Priority class: can be assigned via hardware configuration
OB82_OB_NUMBR	BYTE	OB-NO. (82)
OB82_RESERVED_1	BYTE	reserved
OB82_IO_FLAG	BYTE	Input module 54h Output module 55h
OB82_MDL_ADDR	INT	Logical base address of the module where the fault occurred
OB82_MDL_DEFECT	BOOL	Module fault
OB82_INT_FAULT	BOOL	Internal error
OB82_EXT_FAULT	BOOL	External error
OB82_PNT_INFO	BOOL	Channel error exists
OB82_EXT_VOLTAGE	BOOL	External power supply was not found
OB82_FLD_CONNCTR	BOOL	Front plug not found
OB82_NO_CONFIG	BOOL	Module is not configured
OB82_CONFIG_ERR	BOOL	Wrong parameters in module

Variable	Data type	Description
OB82_MDL_TYPE	BYTE	Bit 3 ... 0: Module class Bit 4: Channel information available Bit 5: User information available Bit 6: Diagnostic interrupt from substitute Bit 7: reserved
OB82_SUB_MDL_ERR	BOOL	User module incorrect/missing
OB82_COMM_FAULT	BOOL	Communication error
OB82_MDL_STOP	BOOL	Operating mode (0: RUN, 1:STOP)
OB82_WTCH_DOG_FLT	BOOL	Watchdog was triggered
OB82_INT_PS_FLT	BOOL	Module internal power supply failed
OB82_PRIM_BATT_FLT	BOOL	Battery empty
OB82_BCKUP_BATT_FLT	BOOL	Total failed buffering
OB82_RESERVED_2	BOOL	Reserved
OB82_RACK_FLT	BOOL	Expansion unit failure
OB82_PROC_FLT	BOOL	Processor failure
OB82_EPROM_FLT	BOOL	EPROM error
OB82_RAM_FLT	BOOL	RAM error
OB82_ADU_FLT	BOOL	ADC/DAC error
OB82_FUSE_FLT	BOOL	Fuse failure
OB82_HW_INTR_FLT	BOOL	Hardware interrupt lost
OB82_RESERVED_3	BOOL	reserved
OB82_DATE_TIME	DATE_AND_TIME	Date and time of day when the OB was called

6.9.4 OB 83 - I/O_FLT2 - Insert / Remove Module

Description

The CPU operating system calls OB 83 in following situations:

- after insertion / removal of a configured module
- after modifications of module parameters and download of changes to the CPU during RUN

If you have not programmed OB 83, the CPU changes to STOP mode. You can disable/delay/enable the insert/remove interrupt OB with the help of SFCs 39 to 42.

Insert/Remove

Each time a configured module is removed or inserted during the RUN, STOP, and STARTUP modes, an insert/remove interrupt is generated (power supply modules, CPUs and Bus coupler must not be removed in these modes). This interrupt causes an entry in the diagnostic buffer and in the system status list for the CPU involved. The insert/remove OB is also started if the CPU is in the RUN mode. If this OB has not been programmed, the CPU changes to the STOP mode. Then system polls modules in seconds intervals to detect insertion or removal. To enable the CPU to detect the removal and insertion of a module, a minimum time interval of two seconds must expire between removal and insertion. If you remove a configured module in the RUN mode, OB 83 is started. Since the

existence of modules is only monitored at intervals of one second, an access error may be detected first if the module is accessed directly or when the process image is updated. If you insert a module in a configured slot in the RUN mode, the operating system checks whether the type of the module inserted corresponds to the recorded configuration. OB 83 is then started and parameters are assigned if the module types match.

Reconfiguring modules

You can reassign the parameters to existing modules when you modify your system configuration during runtime. This reassignment of parameters is performed by transferring the required parameter data records to the modules. This is the procedure:

1. ➤ OB 83 will be started (Start event: 3367h) after you have assigned new parameters to a module and downloaded this configuration to the CPU in RUN mode. Relevant OB start information is the logical basic address (OB83_MDL_ADDR) and the module type (OB83_MDL_TYPE). Module I/O data may be incorrect as of now, which means that no SFC may be busy sending data records to this module.
2. ➤ The module parameters are reassigned after OB 83 was executed.
3. ➤ OB 83 will be restarted after the parameters have been assigned
 - Start event: 3267h, provided this parameter assignment was successful, or
 - 3968h, if failed

The modules I/O data response is identical to their response after an insertion interrupt, that is, currently they may be incorrect. You can now call SFCs again to send data records to the module.

Local Data

The following table describes the start information of the OB 83 with default names of the variables and its data types:

Variable	Data type	Description
OB83_EV_CLASS	BYTE	Event class and identifiers: 32h: End of reassignment of module parameters 33h: Start of reassignment of module parameters 38h: module inserted 39h: module removed or not responding, or end of parameter assignment
OB83_FLT_ID	BYTE	Error code: (possible values: 51h, 54h ... 56h, 58h, 61, 63h ... 68h)
OB83_PRIORITY	BYTE	Priority class: can be assigned via hardware configuration
OB83_OB_NUMBR	BYTE	OB number (83)
OB83_RESERVED_1	BYTE	Identification of module or submodule/interface module
OB83_MDL_ID	BYTE	54h: Peripheral input (PI) 55h: Peripheral output (PQ)

Variable	Data type	Description
OB83_MDL_ADDR	WORD	<ul style="list-style-type: none"> ■ Central or distributed PROFIBUS DP: <ul style="list-style-type: none"> – Logical base address of the module affected. If it is a mixed module, it is the smallest logical address used in the module. – If the I and O addresses in the mixed block are equal, the logical base address is the one that receives the event identifier. ■ Distributed PROFINET IO: <ul style="list-style-type: none"> – Logical base address of the module/submodule
OB83_RACK_NUM	WORD	<ul style="list-style-type: none"> ■ If OB83_RESERVED_1 = A0h: number of submodule/interface submodule (low byte) ■ If OB83_RESERVED_1 = C4h: <ul style="list-style-type: none"> – central: rack number – distributed PROFIBUS DP: number of DP station (low byte) and DP master system ID (high byte) – distributed PROFINET IO: physical address: identifier bit (bit 15, 1 = PROFINET IO), IO system ID (bits 11 ... 14) and device number (bits 0 ... 10)
OB83_MDL_TYPE	WORD	<ul style="list-style-type: none"> ■ Central or distributed PROFIBUS DP: Module type of affected module (x:irrelevant to the user) <ul style="list-style-type: none"> – x5xxh: analog module – x8xxh: function module – xCxxh: CP – xFxxh: digital module – 8340h: Replacement type identifier for input module – 9340h: Replacement type identifier for output module – A340h: Replacement type identifier for mixed module (I/O) – F340h: Replacement type identifier for uniquely identifiable module (e.g. with packed addresses) ■ Distributed PROFINET IO: <ul style="list-style-type: none"> – 8101h: module type of the inserted module is the same as the module type of the removed module – 8102h: module type of the inserted module is not the same as the module type of the removed module
OB83_DATE_TIME	DATE_AND_TIME	DATE_AND_TIME of day when the OB was called

OB83_EV_CLASS

The following table shows the event that started OB 83:

OB83_EV_CLASS	OB83_FLT_ID	Description
39h	51h	PROFINET IO module removed
	54h	PROFINET IO submodule removed
38h	54h	PROFINET IO submodule inserted and matches configured submodule
	55h	PROFINET IO submodule inserted, but does not match configured submodule
	56h	PROFINET IO submodule inserted, but error with module parameters
	58h	PROFINET IO submodule, access error corrected
39h	61h	Module removed or not responding OB83_MDL_TYPE: Actual module type
38h	61h	Module inserted. Module type OK OB83_MDL_TYPE: Actual module type
	63h	Module inserted but incorrect module type OB83_MDL_TYPE: Actual module type
	64h	Module inserted but problem (module ID cannot be read) OB83_MDL_TYPE: Configured module type
	65h	Module inserted but error in module parameter assignment OB83_MDL_TYPE: Actual module type
39h	66h	Module not responding, load voltage error
38h	66h	Module responds again, load voltage error corrected
33h	67h	Start of module reconfiguration
32h	67h	End of module reconfiguration
39h	68h	Module reconfiguration terminated with error



If you are using a DP-V1- or PROFINET-capable CPU you can obtain additional information on the interrupt with the help of SFB 54 "RALRM" which exceeds the start information of the OB.

6.9.5 OB 85 - OBNL_FLT - Priority Class Error

Description

The operating system of the CPU calls OB 85 whenever one of the following events occurs:

- Start event for an OB that has not been loaded
- Error when the operating system accesses a block
- I/O access error during update of the process image by the system (if the OB 85 call was not suppressed due to the configuration)

The OB 85 may be delayed by means of the SFC 41 and re-enabled by the SFC 42.



If OB 85 has not been programmed, the CPU changes to STOP mode when one of these events is detected.

Local data

The following table describes the start information of the OB 85 with default names of the variables and its data types:

Variable	Type	Description
OB85_EV_CLASS	BYTE	Event class and identifiers: 35h 38h (only with error code B3h, B4h) 39h (only with error code B1h, B2h, B3h, B4h)
OB85_FLT_ID	BYTE	Error code (possible values: A1h, A2h, A3h, A4h, B1h, B2h, B3h, B4h)
OB85_PRIORITY	BYTE	Priority class: 26 (Default value mode RUN) 28 (mode STARTUP)
OB85_OB_NUMBR	BYTE	OB number (85)
OB85_RESERVED_1	BYTE	reserved
OB85_RESERVED_2	BYTE	reserved
OB85_RESERVED_3	INT	reserved
OB85_ERR_EV_CLASS	BYTE	Class of the event that caused the error
OB85_ERR_EV_NUM	BYTE	Number of the event that caused the error
OB85_OB_PRIOR	BYTE	Priority class of the OB that was active when the error occurred
OB85_OB_NUM	BYTE	Number of the OB that was active when the error occurred
OB85_DATE_TIME	DATE_AND_TIME	Date and time of day when the OB was called

Information to access the local data can be found at the description of the OB 1.

OB 85 dependent on error codes

If you want to program OB 85 dependent on the possible error codes, we recommend that you organize the local variables as follows:

Variable	Type
OB85_EV_CLASS	BYTE
OB85_FLT_ID	BYTE
OB85_PRIORITY	BYTE
OB85_OB_NUMBR	BYTE
OB85_DKZ23	BYTE
OB85_RESERVED_2	BYTE
OB85_Z1	WORD
OB85_Z23	DWORD
OB85_DATE_TIME	DATE_AND_TIME

The following table shows the event that started OB 85:

Asynchronous error Interrupts > OB 85 - OB_NL_FLT - Priority Class Error

OB85_EV_CLASS	OB85_FLT_ID	Variable	Description
35h	A1h, A2h		As a result of your configuration your program or the operating system creates a start event for an OB that is not loaded on the CPU.
	A1h, A2h	OB85_Z1	The respective local variable of the called OB that is determined by OB85_Z23.
	A1h, A2h	OB85_Z23	high word: Class and number of the event causing the OB call low word, high byte: Program level and OB active at the time of error low word, low byte: Active OB
35h	A3h		Error when the operating system accesses a module
		OB85_Z1	Error ID of the operating system high byte: 1: Integrated function 2: IEC-Timer low byte: 0: no error resolution 1: block not loaded 2: area length error 3: write-protect error
		OB85_Z23	high word: block number low word: Relative address of the MC7 command causing the error. The block type must be taken from OB85_DKZ23. (88h: OB, 8Ch: FC, 8Eh: FB, 8Ah: DB)
35h	A4h		PROFINET DB cannot be addressed
34h	A4h		PROFINET DB can be addressed again
39h	B1h		I/O access error when updating the process image of the inputs
	B2h		I/O access error when transferring the output process image to the output modules
	B1h, B2h	OB85_DKZ23	ID of the type of process image transfer where the I/O access error happened. 10h: Byte access 20h: Word access 30h: DWord access 57h: Transmitting a configured consistency range

OB85_EV_CLASS	OB85_FLT_ID	Variable	Description
	B1h, B2h	OB85_Z1	Reserved for internal use by the CPU: logical base address of the module If OB85_RESERVED_2 has the value 76h OB85_Z1 receives the return value of the affected SFC
	B1h, B2h	OB85_Z23	Byte 0: Part process image number Byte 1: Irrelevant, if OB85_DKZ23=10, 20 or 30 OB85_DKZ23=57: Length of the consistency range in bytes The I/O address causing the PII, if OB85_DKZ23=10, 20 or 30 OB85_DKZ23=57: Logical start address of the consistency range
You obtain the error codes B1h and B2h if you have configured the repeated OB 85 call of I/O access errors for the system process image table update.			
38h, 39h	B3h		I/O access error when updating the process image of the inputs, incoming/outgoing event
38h, 39h	B4h		I/O access error when updating the process image of the outputs, incoming/outgoing event
	B3h, B4h	OB85_DKZ23	ID of the type of process image transfer during which the I/O access error has occurred: 10h: Byte access 20h: Word access 30h: DWord access 57h: Transmitting a configured consistency range
	B3h, B4h	OB85_Z1	Reserved for internal use by the CPU: logical base address of the module. If OB85_RESERVED_2 has the value 76h OB85_Z1 receives the return value of the affected SFC
	B3h, B4h	OB85_Z23	Byte 0: Part process image number Irrelevant, if OB85_DKZ23=10, 20 or 30 OB85_DKZ23=57: Length of the consistency range in bytes Byte 2, 3 The I/O address causing the PII, if OB85_DKZ23=10, 20 or 30 OB85_DKZ23=57: Logical start address of the consistency range
You obtain the error codes B3h or B4h, if you configured the OB 85 call of I/O access errors entering and outgoing event for process image table updating by the system. After a restart, all access to non-existing inputs and outputs will be reported as I/O access errors during the next process table updating.			

6.9.6 OB 86 - RACK_FLT - Slave Failure / Restart

Description

The operating system of the CPU calls OB 86 whenever the failure of a slave is detected (both when entering and outgoing event).



If OB 86 has not been programmed, the CPU changes to the STOP mode when this type of error is detected.

The OB 86 may be delayed by means of the SFC 41 and re-enabled by the SFC 42.

Local data

The following table describes the start information of the OB 86 with default names of the variables and its data types:

Variable	Type	Description
OB86_EV_CLASS	BYTE	Event class and identifiers: 38h: outgoing event 39h: incoming event
OB86_FLT_ID	BYTE	Error code: (possible values: C4h, C5h, C7h, C8h)
OB86_PRIORITY	BYTE	Priority class: may be assigned via hardware configuration
OB86_OB_NUMBR	BYTE	OB number (86)
OB86_RESERVED_1	BYTE	reserved
OB86_RESERVED_2	BYTE	reserved
OB86_MDL_ADDR	WORD	Depends on the error code
OB86_RACKS_FLTD	ARRAY (0 ... 31) OF BOOL	Depends on the error code
OB86_DATE_TIME	DATE_AND_TIME	Date and time of day when the OB was called

Information to access the local data can be found at the description of the OB 1.

OB 86 depending on error codes

If you want to program OB 86 dependent on the possible error codes, we recommend that you organize the local variables as follows:

Variable	Type
OB86_EV_CLASS	BYTE
OB86_FLT_ID	BYTE
OB86_PRIORITY	BYTE
OB86_OB_NUMBR	BYTE
OB86_RESERVED_1	BYTE

Variable	Type
OB86_RESERVED_2	BYTE
OB86_MDL_ADDR	WORD
OB86_Z23	DWORD
OB86_DATE_TIME	DATE_AND_TIME

The following table shows the event started OB 86:

EV_CLASS	FLT_ID	Variable	Bit ...	Description	
39h, 38h	C4h			Failure of a DP station	
	C5h			Fault in a DP station	
	C4h, C5h	OB86_MDL_ADDR			Logical base address of the DP master
			OB86_Z23		Address of the affected DP slave:
				Bit 7 ... 0	Number of the DP station
				Bit 15 ... 8	DP master system ID
				Bit 30 ... 16	Logical base address of the DP slave
Bit 31	I/O identifier				
38h	C7h			Return of a DP station, but error in module parameter assignment	
		OB86_MDL_ADDR		Logical base address of the DP master	
		OB86_Z23		Address of the DP slaves affected:	
			Bit 7 ... 0	Number of the DP station	
			Bit 15 ... 8	DP master system ID	
			Bit 30 ... 16	Logical base address of the DP slave	
			Bit 31	I/O identifier	
	C8h			Return of a DP station, however discrepancy in configured and actual configuration	
		OB86_MDL_ADDR		Logical base address of the DP master	
		OB86_Z23		Address of the DP slaves affected:	
			Bit 7 ... 0	Number of the DP station	
			Bit 15 ... 8	DP master system ID	
			Bit 30 ... 16	Logical base address of the DP slave	
			Bit 31	I/O identifier	

6.10 Synchronous Interrupts

6.10.1 OB 121 - PROG_ERR - Programming Error

Description

The operating system of the CPU calls OB 121 whenever an event occurs that is caused by an error related to the processing of the program. If OB 121 is not programmed, the CPU changes to STOP. For example, if your program calls a block that has not been loaded on the CPU, OB 121 is called.

OB 121 is executed in the same priority class as the interrupted block. So you have read/write access to the registers of the interrupted block.

Masking of start events

The CPU provides the following SFCs for masking and unmasking start events for OB 121 during the execution of your program:

- SFC 36 MSK_FLT masks specific error codes.
- SFC 37 DMSK_FLT unmaskes the error codes that were masked by SFC 36.
- SFC 38 READ_ERR reads the error register.

Local data

The following table describes the start information of the OB 121 with default names of the variables and its data types:

Variable	Data type	Description
OB121_EV_CLASS	BYTE	Event class and identifiers: 25h
OB121_SW_FLT	BYTE	Error code
OB121_PRIORITY	BYTE	Priority class: priority class of the OB in which the error occurred.
OB121_OB_NUMBR	BYTE	OB number (121)
OB121_BLK_TYPE	BYTE	Type of block where the error occurred 88h: OB, 8Ah: DB, 8Ch: FC, 8Eh: FB
OB121_RESEVED_1	BYTE	reserved (Data area and access type)
OB121_FLT_REG	WORD	Source of the error (depends on error code). For example: <ul style="list-style-type: none"> ■ Register where the conversation error occurred ■ Incorrect address (read/write error) ■ Incorrect timer/counter/block number ■ Incorrect memory area
OB121_BLK_NUM	WORD	Number of the block with command that caused the error.
OB121_PRG_ADDR	WORD	Relative address of the command that caused the error.
OB121_DATE_TIME	DATE_AND_TIME	Date and time of day when the OB was called.

Information to access the local data can be found at the description of the OB 1.

Error codes

The variables dependent on the error code have the following meaning:

Error code	Variable	Description
21h	OB121_FLT_REG:	BCD conversion error
		ID for the register concerned (0000h: accumulator 1)
22h	OB121_RESERVED_1	Area length error when reading
23h		Area length error when writing
28h		Read access to a byte, word or double word with a pointer whose bit address is not 0.
29h		Write access to a byte, word or double word with a pointer whose bit address is not 0.
		Incorrect byte address. The data area and access type can be read from OB121_RESERVED_1.
	Bit 3 ... 0 memory area: 0: I/O area 1: process-image input table 2: process-image output table 3: bit memory 4: global DB 5: instance DB 6: own local data 7: local data of caller Bit 7 ... 4 access type: 0: bit access 1: byte access 2: word access 3: double word access	
24h	OB121_FLT_REG	Range error when reading
25h		Range error when writing Contains the ID of the illegal area in the low byte (86h of own local data area)
26h	OB121_FLT_REG	Error for timer number
27h		Error for counter number Illegal number
30h	OB121_FLT_REG	Write access to a write-protected global DB
31h		Write access to a write-protected instance DB
32h		DB number error accessing a global DB
33h		DB number error accessing an instance DB
		Illegal DB number
34h	OB121_FLT_REG	FC number error in FC call

Error code	Variable	Description
35h		FB number error in FB call
3Ah		Access to a DB that has not been loaded; the DB number is in the permitted range
3Ch		Access to an FC that has not been loaded; the FC number is in the permitted range
3Dh		Access to an SFC that has not been loaded; the SFC number is in the permitted range
3Eh		Access to an FB that has not been loaded; the FB number is in the permitted range
3Fh		Access to an SFB that has not been loaded; the SFB number is in the permitted range
		Illegal DB number

6.10.2 OB 122 - MOD_ERR - Periphery access Error

Description

The operating system of the CPU calls OB 122 whenever an error occurs while accessing data on a module. For example, if the CPU detects a read error when accessing data on an I/O module, the operating system calls OB 122. If OB 122 is not programmed, the CPU changes from the RUN mode to the STOP mode.

OB 122 is executed in the same priority class as the interrupted block. So you have read/write access to the registers of the interrupted block.

Masking of start events

The CPU provides the following SFCs for masking and unmasking start events for OB 122:

- SFC 36 MASK_FLT masks specific error codes
- SFC 37 DMASK_FLT unmasks the error codes that were masked by SFC 36
- SFC 38 READ_ERR reads the error register

Local data

The following table describes the start information of the OB 122 with default names of the variables and its data types:

Variable	Type	Description
OB122_EV_CLASS	BYTE	Event class and identifiers: 29h
OB122_SW_FLT	BYTE	Error code: 42h: I/O access error - reading 43h: I/O access error - writing
OB122_PRIORITY	BYTE	Priority class: Priority class of the OB where the error occurred
OB122_OB_NUMBR	BYTE	OB number (122)
OB122_BLK_TYPE	BYTE	No valid number is entered here

Variable	Type	Description
OB122_MEM_AREA	BYTE	Memory area and access type: Bit 3 ... 0: memory area 0: I/O area; 1: Process image of the inputs 2: Process image of the outputs Bit 7 ... 4: access type: 0: Bit access, 1: Byte access, 2: Word access, 3: Dword access
OB122_MEM_ADDR	WORD	Memory address where the error occurred
OB122_BLK_NUM	WORD	No valid number is entered here
OB122_PGR_ADDR	WORD	No valid number is entered here
OB122_DATE_TIME	DATE_AND_TIME	Date and time of day when the OB was called

Information to access the local data can be found at the description of the OB 1.

7 Building Control

Block library "Building Control"

The block library can be found for download in the 'Service/Support' area of www.vipa.com at 'Downloads → VIPA Lib' as 'Block library Building Control - SW90ES0MA'. The library is available as packed zip file. As soon as you want to use these blocks you have to import them into your project. ↪ [Chap. 5 'Include VIPA library' page 69](#)

7.1 Overview

In this chapter the function blocks (FB45 ... FB50) for building control (GLT) can be found. The blocks use the system time of the CPU. There are no S7 timers required. You have the option to use for each block an instance data block or multiple instances. There are the following blocks:

FB		Description
FB 45	LAMP	Controlling a lamp or socket
FB 46	BLIND	Controlling blind
FB 47	DSTRIKE	Controlling an electric door opener
FB 48	ACONTROL	Access control
FB 49	KEYPAD	Requesting a keypad with external power supply
FB 50	KEYPAD2	Requesting a keypad without external power supply

7.1.1 Call example - instance DB

Network 1

```
CALL "Ceiling lamp", DB 1
  ON      :=M20.0
  OFF     :=20.1
  ONOFF   :=20.2
  Duration :=T#5M
  Output  :=M20.3
  PulseOn  :=
  PulseOff :=
```

7.1.2 Call example - multi instances DB

Content of: "Environment Interface\Stat"

In the following there is a STL call example of the usage of multiple lights and a blind with multiple instances.

Name	Data type	Address
Ceiling lamp	LAMP	0.0
Floor lamp	LAMP	46.0
Mirror lamp	LAMP	92.0
Blind	BLIND	138.0

Network 1

```
CALL #Ceiling lamp
  ON      :=M20.0
  OFF     :=20.1
  ONOFF   :=20.2
  Duration :=T#5M
  Output  :=M20.3
  PulseOn :=
  PulseOff :=
```

Network 2

```
CALL #Blind
  Up           :=M30.0
  Down        :=M30.1
  CentralUp   :=
  CentralDown :=
  TimeMaxDuration :=T#10S
  TimePause   :=T#1S
  TimeShortLong :=T#2S
  Endable     :=
  BlindUp     :=M30.6
  BlindDown   :=M30.7
```

7.2 Room

7.2.1 FB 45 - LAMP - Controlling lamp / socket

Description

With this block you can control load relays for lamps and sockets. It can be controlled via On/Off button or via separate On and Off button. Additionally with *Duration* you have the possibility to set a duration for the automatic switching-off. With *TimeDebounce* you can specify a debounce time for the input signals.

- When driving a monostable relay the output remains set as long as the relay is to be activated. With an edge change 0-1 at *OnOff* respectively *On* the static output *Output* is set. It remains set until you reset it with an edge change 0-1 at *OnOff* respectively *Off* or the time of *Duration* has expired.
- When controlling a bistable relay 2 outputs are used. Here *PulseOn* controls the switch on and *PulseOff* the switch off procedure. With *TimePulse* the pulse duration and with *TimePause* the switch time of the two outputs can be specified.

Parameters

Parameter	Declaration	Data type	Description
OnOff	INPUT	BOOL	With an edge change 0-1 <i>Output</i> is activated respectively deactivated and <i>PulseOn</i> or <i>PulseOff</i> is activated. Default: FALSE
On	INPUT	BOOL	With an edge change 0-1 <i>Output</i> is activated respectively deactivated and <i>PulseOn</i> is activated. Default: FALSE
Off	INPUT	BOOL	With an edge change 0-1 <i>Output</i> is deactivated and <i>PulseOff</i> is activated. Default: FALSE

Parameter	Declaration	Data type	Description
Duration	INPUT	TIME	Time for the duration the <i>Output</i> is deactivated respectively <i>PulseOff</i> is activated. With 0ms the automatic switch off is deactivated. Default: 0ms
Output	OUTPUT	BOOL	Static output to drive a monostable relay.
PulseOn	OUTPUT	BOOL	Pulse output to control the bistable relay (On signal).
PulseOff	OUTPUT	BOOL	Pulse output to control the bistable relay (Off signal).
TimeDebounce	CONSTANT	TIME	Time for debounce of the inputs. Default: 100ms
TimePulse	CONSTANT	TIME	Time for the pulse duration of <i>PulseOn</i> respectively <i>PulseOff</i> . Default: 100ms
TimePause	CONSTANT	TIME	Time for the break between resetting and setting of <i>PulseOn</i> respectively <i>PulseOff</i> . Default: 100ms

7.2.2 FB 46 - BLIND - Controlling blind

Description

With this block a motorized blind can be controlled. For this you have to release the drive with *Enable*.

- The controlling for “lifting” *BlindUp* and “sinking” *BlindDown* happens by 2 buttons (*Up/Down* respectively *CentralUp/CentralDown*).
 - *CentralUp/CentralDown*: Used for central control of all blinds in a building.
 - *Up/Down*: Used for local control of a blind. Here a pending *CentralUp/CentralDown* signal is ignored.
- If the corresponding button is pressed longer as the specified *TimeShortLong* the blind drive moves to the respective end position. By pressing on of the two buttons (*Up/Down* respectively *CentralUp/CentralDown*) you can stop the movement and reverse, if it necessary.
- With *TimeMaxDuration* you can specify the maximum run time of the motor and with *TimePause* you can specify the pause for the change of direction.
- By jogging the blind drive shortly moves. With this function you can adjust the blind slats fine.
- With *TimeDebounce* you can specify a debounce time for the input signals.
- With *Status* you can check the position of the blind.
 - 0: Upper limit position
 - 50: Unknown position between the two limit positions
 - 100: Lowest limit position



CAUTION!

The blind drive must have its own limit switches that turn off power automatically!

Parameters

Parameter	Declaration	Data type	Description
Up	INPUT	BOOL	<p>With an edge change 0-1 the output <i>BlindUp</i> is activated. Depending on the input signal the blind drives to the upper limit position or is shortly moved.</p> <p>As long as the signal is pending the signals <i>CentralUp/CentralDown</i> are ignored.</p> <p>Default: FALSE</p>
Down	INPUT	BOOL	<p>With an edge change 0-1 the output <i>BlindDown</i> is activated. Depending on the input signal the blind drives to the lower limit position or is shortly moved.</p> <p>As long as the signal is pending the signals <i>CentralUp/CentralDown</i> are ignored.</p> <p>Default: FALSE</p>
CentralUp	INPUT	BOOL	<p>With an edge change 0-1 the output <i>BlindUp</i> is activated. Here the blind moves to the upper limit position.</p> <p>Default: FALSE</p>
CentralDown	INPUT	BOOL	<p>With an edge change 0-1 the output <i>BlindDown</i> is activated. Here the blind moves to the lowest limit position.</p> <p>Default: FALSE</p>
TimeMaxDuration	INPUT	TIME	<p>Maximum drive time to reach the respective end position.</p> <p>Default: 30s</p>
TimePause	INPUT	TIME	<p>Break between a direction change.</p> <p>Default: 2s</p>
TimeShortLong	INPUT	TIME	<p>Time for the distinction between jog mode and continuous mode.</p> <p>Default: 1s</p>
Enable	INPUT	BOOL	<p>Release for the drive (static)</p> <p>Default: TRUE</p>
BlindUp	OUTPUT	BOOL	Static output blind "lifting"
BlindDown	OUTPUT	BOOL	Static output blind "sinking"
Status	OUTPUT	INT	<ul style="list-style-type: none"> ■ Status - Blind position <ul style="list-style-type: none"> – 0: Upper limit position – 50: Unknown position between the two limit positions – 100: Lowest limit position
TimeDebounce	CONSTANT	TIME	<p>Time for debounce of the inputs.</p> <p>Default: 100ms</p>

7.2.3 FB 47 - DSTRIKE - Electric door opener

Description

With this block an electric door opener can be controlled, if its not locked with *DoorIsLocked*.

- With an edge change 0-1 at the input *Open* for the duration '*TimeOpening*' '*Output*' is controlled.
- With an edge change 0-1 at the input *EnableAlwaysOpen* respectively *DisableAlwaysOpen* *Open* is static activated respectively deactivated. Additionally with set *EnableAlwaysOpen* the static output *AlwaysOpen* is set.
- You can connect your door contacts at *DoorIsClosed* and *DoorIsLocked*. *DoorIsClosed* is set, as soon as the door is closed. *DoorIsLocked* is set as soon as the door is locked, i.e. the contact is controlled by the locking mechanism of the door and opening of the door by means of the electric door opener is disabled.

Parameters

Parameter	Declaration	Data type	Description
Open	INPUT	BOOL	With an edge change 0-1 <i>Output</i> is activated for the duration of <i>TimeOpening</i> . Default: FALSE
EnableAlwaysOpen	INPUT	BOOL	With an edge change 0-1 <i>Output</i> is static set. Default: FALSE
DisableAlwaysOpen	INPUT	BOOL	With an edge change 0-1 <i>Output</i> is static reset. Default: FALSE
TimeOpening	INPUT	TIME	Time for the duration of the activation of <i>Output</i> . Default: 3s
DoorIsClosed	INPUT	BOOL	<ul style="list-style-type: none"> ■ Optional - Position door TRUE: Door is closed FALSE: Door is open Default: FALSE
DoorIsLocked	INPUT	BOOL	<ul style="list-style-type: none"> ■ Optional - Lock state of the door – TRUE: Door is locked – FALSE: Door is not locked Default: FALSE
Output	OUTPUT	BOOL	Static output to drive a monostable relay.
AlwaysOpen	OUTPUT	BOOL	Static output to indicate "Door is static open".

7.3 Access Control

7.3.1 FB 48 - ACONTROL - Access control

Description

With this block a access control can be implemented. After getting a code from an external keypad, panel or RFID reader, the code is compared with a list. Depending on the result, then the relative outputs are controlled.

- The access codes are to be applied in a data block, which is specified by *ACLBlock*. Here you can also specify which outputs *Access1...6* are to be controlled and how (pulse/static) are they controlled. With the data block up to 16 access codes can be treaded.
- Via *AccessCode1...4* the code of the corresponding input device is specified.
- Via *CheckCode1...4* the code is compared with the code in your data block *ACLBlock*.
 - If the access code in the data block exists, the corresponding outputs are controlled according to the specifications. With configured pulse output you can specify the pulse duration with *TimePulse*.
 - If the access code does not exist in the data block, the output *Error* is set for the duration *TimeError*.
- With an edge change 0-1 of *CentralLock* all the access codes are disabled. Here the output *CentralLocked* is set.
- With an edge change 0-1 of *CentralUnlock* all the access codes are enabled and the output *CentralLocked* is reset.

Parameters

Parameter	Declaration	Data type	Description
AccessCode1	INPUT	STRING[16]	Access code, e.g. from keypad.
CheckCode1	INPUT	BOOL	With an edge change 0-1, the <i>AccessCode1</i> is compared with the access code in the data block <i>ACLBlock</i> . Default: 0
AccessCode2	INPUT	STRING[16]	Access code, e.g. from panel.
CheckCode2	INPUT	BOOL	With an edge change 0-1, the <i>AccessCode2</i> is compared with the access code in the data block <i>ACLBlock</i> . Default: 0
AccessCode3	INPUT	STRING[16]	Access code, e.g. RFID reader.
CheckCode3	INPUT	BOOL	With an edge change 0-1, the <i>AccessCode3</i> is compared with the access code in the data block <i>ACLBlock</i> . Default: 0
AccessCode4	INPUT	STRING[16]	Access code, e.g. from an other system
CheckCode4	INPUT	BOOL	With an edge change 0-1, the <i>AccessCode4</i> is compared with the access code in the data block <i>ACLBlock</i> . Default: 0
CentralLock	INPUT	BOOL	With an edge change 0-1 all the access codes are disabled. Here the output <i>CentralLocked</i> is set.
CentralUnlock	INPUT	BOOL	With an edge change 0-1 of <i>CentralUnlock</i> all the access codes are enabled and the output <i>CentralLocked</i> is reset.

Parameter	Declaration	Data type	Description
ACLBlock	INPUT	BLOCK	Data block with the access codes. ↗ Chap. 7.3.3 'UDT 4 - ACL - Data structure for FB 48' page 109
Access1	OUTPUT	BOOL	Output 1, can be controlled as pulse or static.
Access2	OUTPUT	BOOL	Output 2, can be controlled as pulse or static.
Access3	OUTPUT	BOOL	Output 3, can be controlled as pulse or static.
Access4	OUTPUT	BOOL	Output 4, can be controlled as pulse or static.
Access5	OUTPUT	BOOL	Output 5, can be controlled as pulse or static.
Access6	OUTPUT	BOOL	Output 6, can be controlled as pulse or static.
Error	OUTPUT	BOOL	If the access code does not exist in the data block, the output <i>Error</i> is set for the duration <i>TimeError</i> .
CentralLocked	OUTPUT	BOOL	<ul style="list-style-type: none"> ■ Access <ul style="list-style-type: none"> – TRUE: locked - access not possible – FALSE: not locked - access possible Default: TRUE
TimePulse	CONSTANT	Time	Time for the pulse duration at an output. Default: 3s
TimeError	CONSTANT	Time	Time for the duration of the error signal. Default: 500ms

7.3.2 UDT 3 - ACLREC - Data structure for FB 48

Description

Address	Name	Type	Start value	Comment
0.0		STRUCT		
+0.0	Code	STRING[16]	''	Byte 0 ... 17: Access code S7String with max. 16 ASCII characters for access code
+18.0	EnableOutput1	BOOL	FALSE	Byte 18: Signal for the outputs to be controlled TRUE: activate output, FALSE: deactivate output
+18.1	EnableOutput2	BOOL	FALSE	
+18.2	EnableOutput3	BOOL	FALSE	
+18.3	EnableOutput4	BOOL	FALSE	
+18.4	EnableOutput5	BOOL	FALSE	
+18.5	EnableOutput6	BOOL	FALSE	
+18.6	EnableRes7	BOOL	FALSE	
+18.7	EnableRes8	BOOL	FALSE	

Address	Name	Type	Start value	Comment
0.0		STRUCT		
+19.0	SignalOutput1	BOOL	FALSE	Byte 19: Signal type FALSE: Pulse, TRUE: static 1, deactivation with additional code
+19.1	SignalOutput2	BOOL	FALSE	
+19.2	SignalOutput3	BOOL	FALSE	
+19.3	SignalOutput4	BOOL	FALSE	
+19.4	SignalOutput5	BOOL	FALSE	
+19.5	SignalOutput6	BOOL	FALSE	
+19.6	SignalRes7	BOOL	FALSE	
+19.7	SignalRes8	BOOL	FALSE	
=20.0				

7.3.3 UDT 4 - ACL - Data structure for FB 48

Description

Address	Name	Type	Start value	Comment
0.0		STRUCT		
+0.0	RecordCount	INT	16	DBW0: Number valid record sets (0 ... n)
+2.0	RecordLen	INT	20	DBW2: Length of one record set in bytes (20)
+4.0	Record	ARRAY[0...15]		The first record set starts from DBB4
*20.0		"UDT 3 - ACLREC"		🔗 <i>Chap. 7.3.2 'UDT 3 - ACLREC - Data structure for FB 48' page 108</i>
=324.0		BOOL		



CAUTION!

A code must only occur 1 x in the whole list. Duplicate Codes are not allowed.

7.3.4 FB 49 - KEYPAD - Keyboard

Description

This block is used to connect an external keypad (0...9,*,#) with external DC 24V power supply. Depending on the pressed key, the keyboard provides the row and column signals (24V). The block evaluates the signals internally by means of a bit pattern table and transfers the determined ASCII code into the keyboard buffer. If necessary, or automatically the keyboard buffer is output as max. 16byte character string.

- Via *Row 1...4* the rows 1...4 of the keyboard matrix are connected.
- Via *Column 1...3* the columns 1...3 of the keyboard matrix are connected.
- Via *ClearCode* you can specify a key code to clear the keyboard buffer.

- Via *EnterCode* you can specify a key code to output the keyboard buffer at *Output* for one cycle. During this time the output *Valid* is enabled.
- Via edge change 0-1 of *Clear* the keyboard buffer cleared.
- Via *TimeAutoClear* you specify the max. duration for pressing the keys. Otherwise the keyboard buffer is cleared.
- Via *CountCharAutoEnter* you can specify the number of characters, which are automatically output as keyboard buffer at *Output* for one cycle. During this time the output *Valid* is enabled.
- *Error* is activated for the time *TimeError* when a key is pressed, but the keyboard buffer is full.
- With *TimeDebounce* you can specify a debounce time for the input signals.

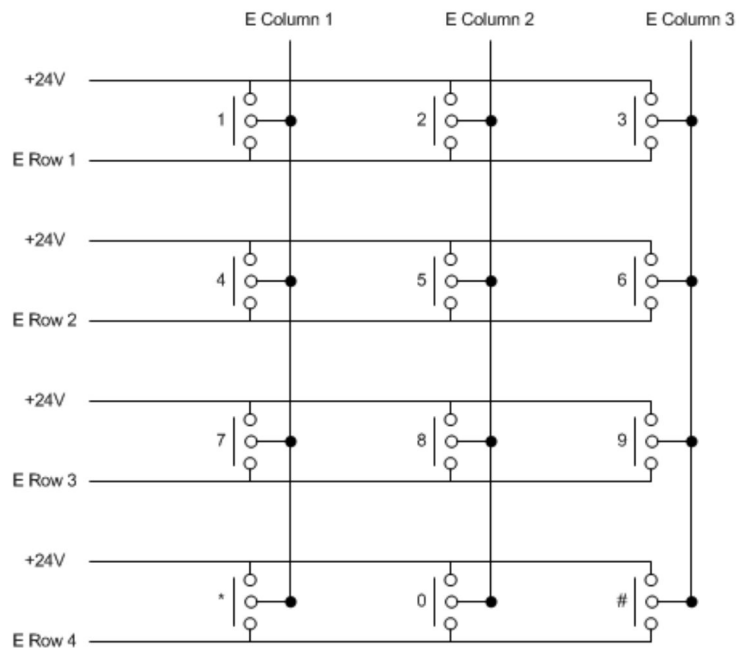

Parameters

Parameter	Declaration	Data type	Description
Row1	INPUT	BOOL	Row 1 of the keyboard matrix. Default: FALSE
Row2	INPUT	BOOL	Row 2 of the keyboard matrix. Default: FALSE
Row3	INPUT	BOOL	Row 3 of the keyboard matrix. Default: FALSE
Row4	INPUT	BOOL	Row 4 of the keyboard matrix. Default: FALSE
Column1	INPUT	BOOL	Column 1 of the keyboard matrix. Default: FALSE
Column2	INPUT	BOOL	Column 2 of the keyboard matrix. Default: FALSE

Parameter	Declaration	Data type	Description
Column3	INPUT	BOOL	Column 3 of the keyboard matrix. Default: FALSE
ClearCode	INPUT	BYTE	The value at which the keyboard buffer is to be cleared. 0: deactivated Default: 42 = *
EnterCode	INPUT	BYTE	The value at which the keyboard buffer is to be output. 0: deactivated Default: 35 = #
Clear	INPUT	BOOL	Edge change 0-1 clears the keyboard buffer. Default: FALSE
TimeAutoClear	INPUT	TIME	Duration within a further key must be pressed. Otherwise the keyboard buffer is cleared. 0: Buffer is not cleared Default: 10s
CountCharAutoEnter	INPUT	INT	Number of characters, which are automatically output as keyboard buffer. 0: deactivated Default: 0
Output	OUTPUT	STRING[16]	Contents of the keyboard buffer as max. 16 byte string.
Valid	OUTPUT	BOOL	The static output indicates that the string at <i>Output</i> is valid. The signal is pending for one cycle.
Error	OUTPUT	BOOL	<i>Error</i> is activated for the time <i>TimeError</i> when a key is pressed, but the keyboard buffer is full.
TimeDebounce	CONSTANT	TIME	Time for debounce of the inputs. Default: 100ms
TimeError	CONSTANT	TIME	Time for the duration of the error signal. Default: 500ms

7.3.5 FB 50 - KEYPAD2 - Keyboard

Description

This block is used to connect an external keypad (0...9,*,#) without an own power supply. The block provides output column signals. Depending on the pressed key, the keyboard provides the according row signals. The block evaluates the signals internally by means of a bit pattern table and transfers the determined ASCII code into the keyboard buffer. If necessary, or automatically the keyboard buffer is output as max. 16byte character string.

- Via *Row 1...4* the rows 1...4 of the keyboard matrix are connected.
- Via *Column 1...3* the columns 1...3 of the keyboard matrix are connected.
- Via *TimeDelay* you can specify a waiting time after setting the column outputs up to reading the corresponding row inputs. This time must be greater than the delay time of the used module.
- Via *ClearCode* you can specify a key code to clear the keyboard buffer.

- Via *EnterCode* you can specify a key code to output the keyboard buffer at *Output* for one cycle. During this time the output *Valid* is enabled.
- Via edge change 0-1 of *Clear* the keyboard buffer cleared.
- Via *TimeAutoClear* you specify the max. duration for pressing the keys. Otherwise the keyboard buffer is cleared.
- Via *CountCharAutoEnter* you can specify the number of characters, which are automatically output as keyboard buffer at *Output* for one cycle. During this time the output *Valid* is enabled.
- *Error* is activated for the time *TimeError* when a key is pressed, but the keyboard buffer is full.
- With *TimeDebounce* you can specify a debounce time for the input signals.

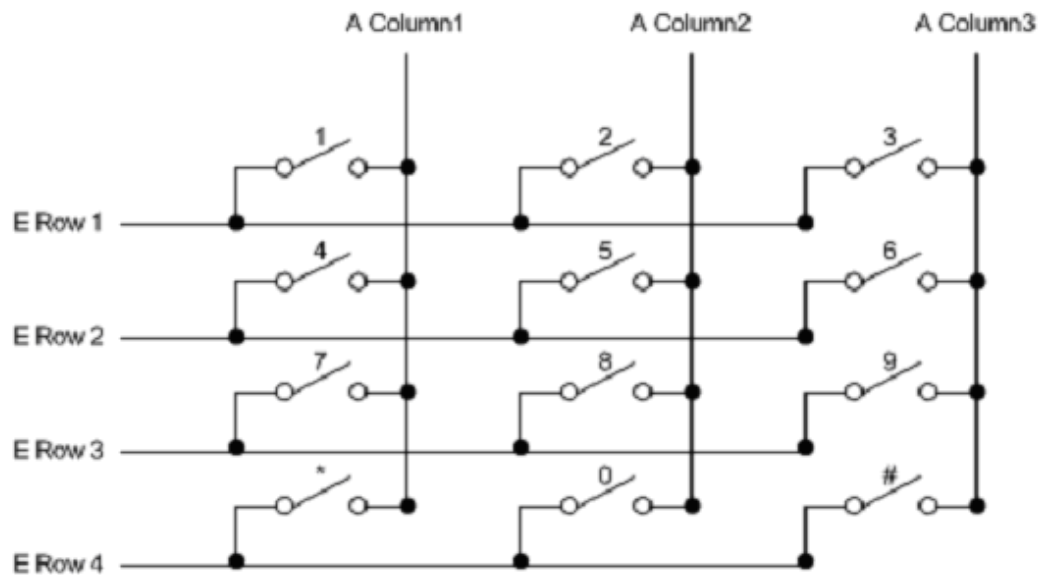

Parameters

Parameter	Declaration	Data type	Description
Row1	INPUT	BOOL	Row 1 of the keyboard matrix. Default: FALSE
Row2	INPUT	BOOL	Row 2 of the keyboard matrix. Default: FALSE
Row3	INPUT	BOOL	Row 3 of the keyboard matrix. Default: FALSE
Row4	INPUT	BOOL	Row 4 of the keyboard matrix. Default: FALSE
ClearCode	INPUT	BYTE	The value at which the keyboard buffer is to be cleared. 0: deactivated Default: 42 = *
EnterCode	INPUT	BYTE	The value at which the keyboard buffer is to be output. 0: deactivated Default: 35 = #

Parameter	Declaration	Data type	Description
Clear	INPUT	BOOL	Edge change 0-1 clears the keyboard buffer. Default: FALSE
TimeAutoClear	INPUT	TIME	Duration within a further key must be pressed. Otherwise the keyboard buffer is cleared. 0: Buffer is not cleared Default: 10s
CountCharAutoEnter	INPUT	INT	Number of characters, which are automatically output as keyboard buffer. 0: deactivated Default: 0
Column1	OUTPUT	BOOL	Column 1 of the keyboard matrix. Default: FALSE
Column2	OUTPUT	BOOL	Column 2 of the keyboard matrix. Default: FALSE
Column3	OUTPUT	BOOL	Column 3 of the keyboard matrix. Default: FALSE
Output	OUTPUT	BYTE	Contents of the keyboard buffer as max. 16 byte string.
Valid	OUTPUT	BOOL	The static output indicates that the string at <i>Output</i> is valid. The signal is pending for one cycle.
Error	OUTPUT	BOOL	<i>Error</i> is activated for the time <i>TimeError</i> when a key is pressed, but the keyboard buffer is full.
TimeDebounce	CONSTANT	TIME	Time for debounce of the inputs. Default: 100ms
TimeError	CONSTANT	TIME	Time for the duration of the error signal. Default: 500ms
TimeDelay	CONSTANT	TIME	Duration after setting the column outputs up to reading the corresponding row inputs. This time must be greater than the delay time of the used module. Default: 10ms

8 Network Communication

Block library "Network Communication"

The block library can be found for download in the 'Service/Support' area of www.vipa.com at 'Downloads → VIPA Lib' as 'Block library Network Communication - SW90FS0MA'. The library is available as packed zip file. As soon as you want to use these blocks you have to import them into your project. ↪ *Chap. 5 'Include VIPA library' page 69*

8.1 Open Communication

8.1.1 Connection-oriented protocols

- Connection-oriented protocols establish a (logical) connection to the communication partner before data transmission is started. And if necessary they terminate the connection after the data transfer was finished.
- Connection-oriented protocols are used for data transmission when reliable, guaranteed delivery is of particular importance. Also the correct order of the received packets is ensured.
- In general, many logical connections can exist on one physical line.
- The following connection-oriented protocols are supported with FBs for open communication via industrial Ethernet:
 - TCP/IP native according to RFC 793 (connection types 01h and 11h)
 - ISO on TCP according to RFC 1006 connection type 12h)

TCP native

- During data transmission, no information about the length or about the start and end of a message is transmitted. However, the receiver has no means of detecting where one message ends in the data stream and the next one begins.
- The transfer is stream-oriented. For this reason, it is recommended that the data length of the FBs is identical for the sending and receiving station.
- If the number of received data does not fit to the preset length you either will get not the whole data, or you will get data of the following job.
- The receive block copies as many bytes into the receive area as you have specified as length. After this, it will set NDR to TRUE and write RCVD_LEN with the value of LEN. With each additional call, you will thus receive another block of sent data.

ISO on TCP

- During data transmission, information on the length and the end of the message is also transmitted. The transfer is block-oriented
- If you have specified the length of the data to be received greater than the length of the data to be sent, the receive block will copy the received data completely into the receive range. After this, it will set NDR to TRUE and write RCVD_LEN with the length of the sent data.
- If you have specified the length of the data to be received less than the length of the sent data, the receive block will not copy any data into the receive range but instead will supply the following error information: ERROR = 1, STATUS = 8088h.

8.1.2 Connection-less protocols

There is thus no establishment and termination of a connection with a remote partner. Connection-less protocols transmit data with no acknowledge and with no reliable guaranteed delivery to the remote partner. The following connection-oriented protocol is supported with FBs for open communication via Industrial Ethernet:

- UDP according to RFC 768 (with connection type 13h)

UDP

- In this case, when calling the sending block you have to specify the address parameters of the receiver (IP address and port number). During data transmission, information on the length and the end of the message is also transmitted.
- Analog after finishing the receive block you get a reference to the address parameter of the sender (IP address and port no.)
- In order to be able to use the sending and receiving blocks first you have to configure the local communications access point at both sides.
- With each new call of the sending block, you re-reference the remote partner by specifying its IP address and its port number.
- If you have specified the length of the data to be received greater than the length of the data to be sent, the receive block will copy the received data completely into the receive range. After this, it will set NDR to TRUE and write RCVD_LEN with the length of the sent data.
- If you have specified the length of the data to be received less than the length of the sent data, the receive block will not copy any data into the receive range but instead will supply the following error information: ERROR = 1, STATUS = 8088h.

8.1.3 FB 63 - TSEND - Sending data - TCP native and ISO on TCP**Description**

- FB 63 TSEND Sends data over an editing communications connection. FB 63 TSEND is an asynchronously functioning FB, which means that its processing extends over several FB calls.
- To start sending data, call FB 63 with *REQ* = 1.
- The job status is indicated at the output parameters *BUSY* and *STATUS*. *STATUS* corresponds to the *RET_VAL* output parameter of asynchronously functioning SFCs (see also Meaning of the Parameters *REQ*, *RET_VAL* and *BUSY* with Asynchronous SFCs).
- The following table shows the relationships between *BUSY*, *DONE* and *ERROR*. Using this table, you can determine the current status of FB 63 or when the establishment of the connection is complete.

BUSY	DONE	ERROR	Description
TRUE	irrelevant	irrelevant	The job is being processed.
FALSE	TRUE	FALSE	The job was completed successfully.
FALSE	FALSE	TRUE	The job was ended with an error. The cause of the error can be found in the STATUS parameter.
FALSE	FALSE	FALSE	The FB was not assigned a (new) job.



Due to the asynchronous function of FB 63 TSEND, you must keep the data in the sender area consistent until the DONE parameter or the ERROR parameter assumes the value TRUE.

Parameters

Parameter	Declaration	Data type	Memory area	Description
REQ	INPUT	BOOL	I, Q, M, D, L	Control parameter <i>REQ</i> , initiates terminating the connection specified by the <i>ID</i> . Initiation occurs at rising edge. At the first call with <i>REQ</i> = 1, data are transmitted from the area specified by the <i>DATA</i> parameter.
ID	INPUT	WORD	M, D, constant	Reference to the connection to be terminated. <i>ID</i> must be identical to the associated parameter <i>ID</i> in the local connection description. Range of values: 0001h ... 0FFFh
LEN	INPUT	INT	I, Q, M, D, L	Number of bytes to be sent with the job Range of values: <ul style="list-style-type: none"> ■ 1 ... 1460, if connection type = 01h ■ 1 ... 8192, if connection type = 11h ■ 1 ... 1452, if connection type = 12h and a CP is being used ■ 1 ... 8192, if connection type = 12h and no CP is being used
DONE	OUTPUT	BOOL	I, Q, M, D, L	<i>DONE</i> status parameter: <ul style="list-style-type: none"> ■ 0: Job not yet started or still running. ■ 1: Job executed without error.
BUSY	OUTPUT	BOOL	I, Q, M, D, L	<ul style="list-style-type: none"> ■ <i>BUSY</i> = 1: Job is not yet completed. A new job cannot be triggered. ■ <i>BUSY</i> = 0: Job is completed.
ERROR	OUTPUT	BOOL	I, Q, M, D, L	<i>ERROR</i> status parameter: <ul style="list-style-type: none"> ■ <i>ERROR</i> = 1: Error occurred during processing. <i>STATUS</i> provides detailed information on the type of error.
STATUS	OUTPUT	WORD	M, D	<i>STATUS</i> parameter: Status information
DATA	IN_OUT	ANY	I, Q, M, D	Send area, contains address and length. The address refers to: <ul style="list-style-type: none"> ■ The process image input ■ The process image output ■ A bit memory ■ A data block Allowed referenced data types: BOOL, BYTE, CHAR, WORD, INT, DWORD, DINT, REAL, DATE, TIME_OF_DAY, TIME, S5TIME, DATE_AND_TIME, STRING

Status information

ERROR	STATUS	Description
0	0000h	Send job completed without error.
0	7000h	First call with <i>REQ</i> = 0, sending not initiated.
0	7001h	First call with <i>REQ</i> = 1, sending initiated.
0	7002h	Follow-on call (<i>REQ</i> irrelevant), job being processed Note: during this processing the operating system accesses the data in the <i>DATA</i> send buffer.
1	8085h	<i>LEN</i> parameter has the value 0 or is greater than the largest permitted value.
1	8086h	The <i>ID</i> parameter is not in the permitted address range.
0	8088h	<i>LEN</i> parameter is larger than the memory area specified in <i>DATA</i> .
1	80A1h	Communications error: <ul style="list-style-type: none"> ■ FB 65 TCON was not yet called for the specified <i>ID</i> ■ The specified connection is currently being terminated. Transmission over this connection is not possible. ■ The interface is being reinitialized.
1	80B3h	The parameter for the connection type (<i>connection_type</i> parameter in the connection description) is set to UDP. Please use the FB 67 TUSEND.
1	80C3h	The resources (memory) of the CPU are temporarily occupied.
1	80C4h	Temporary communications error: <ul style="list-style-type: none"> ■ The connection to the communications partner cannot be established at this time. ■ The interface is receiving new parameters.
1	8822h	<i>DATA</i> parameter: Source area invalid: area does not exist in DB.
1	8824h	<i>DATA</i> parameter: Range error in ANY pointer.
1	8832h	<i>DATA</i> parameter: DB number too large.
1	883Ah	<i>DATA</i> parameter: Access to send buffer not possible (e.g. due to deleted DB).
1	887Fh	<i>DATA</i> parameter: Internal error, such as an invalid ANY reference.
1	8F7Fh	Internal Error (VIPA specific)
1	8xyyh	General error information ↪ <i>Chap. 4.2 'General and Specific Error Information RET_VAL' page 66</i>

8.1.4 FB 64 - TRCV - Receiving Data - TCP native and ISO on TCP

Description

FB 64 TRCV receives data over an existing communication connection. There are two variants available for receiving and processing the data:

- Variant 1: Received data block is processed immediately.
- Variant 2: Received data block is stored in a receive buffer and is only processed when the buffer is full.

The following table shows the relationships between the connection type as shown in the following table:

Connection type	Variant
01h and 11h	The user can specify the variant.
12h	Variant 2 (fix)

The two variants are more described in the following table.

Received Data ...	Range Values for LEN	Range Values for RCVD_LEN	Description
are available immediately.	0	1 ... x	The data go into a buffer whose length x is specified in the ANY pointer of the receive buffer (<i>DATA</i> parameter). After being received, a data block is immediately available in the receive buffer. The amount of data received (<i>RCVD_LEN</i> parameter) can be no greater than the size specified in the <i>DATA</i> parameter. Receiving is indicated by <i>NDR</i> = 1.
are stored in the receive buffer. The data are available as soon as the configured length is reached.	1 ... 1460, if the connection type = 01h 1 ... 8192, if the connection type = 11h 1 ... 1452, if the connection type = 12h and a CP is being used 1 ... 8192, if the connection type = 12h and no CP is being used	Same value as in the LEN parameter	The data go into a buffer whose length is specified by the LEN parameter. If this specified length is reached, the received data are made available in the <i>DATA</i> parameter (<i>NDR</i> = 1).

Function

- FB 64 TRCV is an asynchronously functioning FB, which means that its processing extends over several FB calls. To start receiving data, call FB 64 with *REQ* = 1.
- The job status is indicated at the output parameters *BUSY* and *STATUS*. *STATUS* corresponds to the *RET_VAL* output parameter of asynchronously functioning SFCs (see also Meaning of the Parameters *REQ*, *RET_VAL* and *BUSY* with Asynchronous SFCs).
- The following table shows the relationships between *BUSY*, *DONE* and *ERROR*. Using this table, you can determine the current status of FB 64 or when the receiving process is complete.

BUSY	DONE	ERROR	Description
TRUE	irrelevant	irrelevant	The job is being processed.
FALSE	TRUE	FALSE	The job was completed successfully.
FALSE	FALSE	TRUE	The job was ended with an error. The cause of the error can be found in the <i>STATUS</i> parameter.
FALSE	FALSE	FALSE	The FB was not assigned a (new) job.



Due to the asynchronous function of FB 64 TRCV, the data in the receiver area are only consistent when the NDR parameter assumes the value TRUE.

Parameters

Parameter	Declaration	Data type	Memory area	Description
EN_R	INPUT	BOOL	I, Q, M, D, L	With <i>EN_R</i> = 1, FB 64 TRCV is ready to receive (Control parameter). The receive job is processed.
ID	INPUT	WORD	M, D, constant	Reference to the connection to be terminated. <i>ID</i> must be identical to the associated parameter <i>id</i> in the local connection description. Range of values: 0001h ... 0FFFh
LEN	INPUT	INT	I, Q, M, D, L	<ul style="list-style-type: none"> ■ <i>LEN</i> = 0 (ad hoc mode): use implied length specified in the ANY pointer for <i>DATA</i>. The received data are made available immediately when the block is called. The amount of data received is available in <i>RCVD_LEN</i>. ■ $1 \leq \text{LEN} \leq \text{max}$: number of bytes to be received. The amount of data actually received is available in <i>RCVD_LEN</i>. The data are available after they have been completely received. "max" depends on the connection type: <ul style="list-style-type: none"> – max = 1460 with connection type 01h – max = 8192 with connection type 11h – max = 1452 with connection type 12h with a CP – max = 8192 with connection type 12h without a CP

Parameter	Declaration	Data type	Memory area	Description
NDR	OUTPUT	BOOL	I, Q, M, D, L	<i>NDR</i> status parameter: <ul style="list-style-type: none"> ■ <i>NDR</i> = 0: Job not yet started or still running. ■ <i>NDR</i> = 1: Job successfully completed
ERROR	OUTPUT	BOOL	I, Q, M, D, L	<i>ERROR</i> status parameter: <ul style="list-style-type: none"> ■ <i>ERROR</i> = 1: Error occurred during processing. <i>STATUS</i> provides detailed information on the type of error
BUSY	OUTPUT	BOOL	I, Q, M, D, L	<ul style="list-style-type: none"> ■ <i>BUSY</i> = 1: Job is not yet completed. A new job cannot be triggered. ■ <i>BUSY</i> = 0: Job is completed.
STATUS	OUTPUT	WORD	M, D	<i>STATUS</i> parameter: Status information
RCVD_LEN	OUTPUT	INT	I, Q, M, D, L	Amount of data actually received, in bytes
DATA	IN_OUT	ANY	I, Q, M, D	Receiving area (address and length)The address refers to: <ul style="list-style-type: none"> ■ The process image input ■ The process image output ■ A bit memory ■ A data block <p>Allowed referenced data types: BOOL, BYTE, CHAR, WORD, INT, DWORD, DINT, REAL, DATE, TIME_OF_DAY, TIME, S5TIME, DATE_AND_TIME, STRING</p>

Status information

ERROR	STATUS	Description
0	0000h	New data were accepted. The current length of the received data is shown in <i>RCVD_LEN</i> .
0	7000h	First call with <i>REQ</i> = 0, receiving not initiated
0	7001h	Block is ready to receive. Receiving job has been activated.
0	7002h	Follow-on call, job being processed Note: during this processing the operating system writes the operating system data to the <i>DATA</i> receive buffer. For this reason, an error could result in inconsistent data being in the receive buffer.
1	8085h	<i>LEN</i> parameter is greater than the largest permitted value, or you changed the value of <i>LEN</i> from the one that existed during the first call
1	8086h	The <i>ID</i> parameter is not in the permitted address range
1	8088h	<ul style="list-style-type: none"> ■ Target buffer (<i>DATA</i>) is too small value <i>LEN</i> is greater than the predetermined by <i>DATA</i>. Troubleshooting if the connection type = 12h: Increase the destination buffer <i>DATA</i>.

ERROR	STATUS	Description
1	80A1h	Communications error: <ul style="list-style-type: none"> ■ FB 65 TCON was not yet called for the specified <i>ID</i> ■ The specified connection is currently being terminated. Receiving over this connection is not possible. ■ The interface is receiving new parameters.
1	80B3h	The parameter for the connection type (<i>connection_type</i> parameter in the connection description) is set to UDP. Please use the FB 68 TRCV.
1	80C3h	The operating resources (memory) in the CPU are temporarily occupied.
1	80C4h	Temporary communications error: The connection is currently being terminated.
1	8922h	<i>DATA</i> parameter: Target area invalid: area does not exist in DB.
1	8924h	<i>DATA</i> parameter: Range error in ANY pointer
1	8932h	<i>DATA</i> parameter: DB number too large.
1	893Ah	<i>DATA</i> parameter: Access to receive buffer not possible (e.g. due to deleted DB)
1	897Fh	<i>DATA</i> parameter: Internal error, such as an invalid ANY reference
1	8F7Fh	Internal Error (VIPA specific)
1	8xyyh	General error information ↗ <i>Chap. 4.2 'General and Specific Error Information RET_VAL' page 66</i>

8.1.5 FB 65 - TCON - Establishing a connection

Use with TCP native and ISO on TCP

Both communications partners call FB 65 TCON to establish the communications connection. In the parameters you specify which partner is the active communications transmission point and which is the passive one. For information on the number of possible connections, please refer to the technical data for your CPU. After the connection is established, it is automatically monitored and maintained by the CPU. If the connection is interrupted, such as due a line break or due to the remote communications partner, the active partner attempts to reestablish the connection. In this case, you do not have to call FB 65 TCON again. An existing connection is terminated when FB 66 TDISCON is called or when the CPU has gone into STOP mode. To reestablish the connection, you will have to call FB 65 TCON again.

Use with UDP

Both communications partner call FB 65 TCON in order to configure their local communications access point. A connection is configured between the user program and the communications level of the operating system. No connection is established to the remote partner. The local access point is used to send and receive UDP message frames.

Description

FB 65 TCON is an asynchronously functioning FB, which means that its processing extends over several FB calls. To start establishing a connection, call FB 65 with REQ = 1. The job status is indicated at the output parameters *RET_VAL* and *BUSY*. *STATUS* corresponds to the *RET_VAL* output parameter of asynchronously functioning SFCs (see also Meaning of the Parameters *REQ*, *RET_VAL* and *BUSY* with asynchronous SFCs). The following table shows the relationships between *BUSY*, *DONE* and *ERROR*. Using this table, you can determine the current status of FB 65 or when the establishment of the connection is complete.

BUSY	DONE	ERROR	Description
TRUE	irrelevant	irrelevant	The job is being processed.
FALSE	TRUE	FALSE	The job was completed successfully.
FALSE	FALSE	TRUE	The job was ended with an error. The cause of the error can be found in the <i>STATUS</i> parameter.
FALSE	FALSE	FALSE	The FB was not assigned a (new) job.

Parameters

Parameter	Declaration	Data type	Memory area	Description
REQ	INPUT	BOOL	I, Q, M, D, L	Control parameter <i>REQ</i> , initiates establishing the connection at rising edge.
ID	INPUT	WORD	M, D, constant	Reference to the connection to be established to the remote partner or between the user program and the communications level of the operating system. ID must be identical to the associated parameter ID in the local connection description. Range of values: 0001h ... 0FFFh
DONE	OUTPUT	BOOL	I, Q, M, D, L	<i>DONE</i> status parameter: <ul style="list-style-type: none"> ■ 0: Job not yet started or still running. ■ 1: Job executed without error.
BUSY	OUTPUT	BOOL	I, Q, M, D, L	<ul style="list-style-type: none"> ■ <i>BUSY</i> = 1: Job is not yet completed. ■ <i>BUSY</i> = 0: Job is completed.

Parameter	Declaration	Data type	Memory area	Description
ERROR	OUTPUT	BOOL	I, Q, M, D, L	<p><i>ERROR</i> status parameter:</p> <ul style="list-style-type: none"> ■ <i>ERROR</i> = 1: Error occurred during processing. <i>STATUS</i> provides detailed information on the type of error.
STATUS	OUTPUT	WORD	M, D	<p><i>STATUS</i> status parameter:</p> <p>Error information</p>
CONNECT	IN_OUT	ANY	D	<p>Pointer to the associated connection description.</p> <p>↳ <i>Chap. 8.1.6 'UDT 65 - TCON_PAR Data structure for FB 65' page 124</i></p>

Status information

ERROR	STATUS	Description
0	0000h	Connection is able to be established
0	7000h	Call with <i>REQ</i> = 0, establishment of connection not initiated
0	7001h	First call with <i>REQ</i> = 1, connection being established
0	7002h	Follow-on call (<i>REQ</i> irrelevant), connection being established
1	8086h	The ID parameter must not have value of zero.
0	8087h	Maximal number of connections reached; no additional connection possible
1	8089h	The <i>CONNECT</i> parameter does not point to a data block.
1	809Ah	The <i>CONNECT</i> parameter points to a field that does not have the length of the data structure for assigning connection (UDT 65).
1	809Bh	The communication interface specified via <i>local_device_id</i> and <i>next_staddr</i> is not supported by the CPU.
1	80A1h	Connection or port is already occupied by the user.
1	80A2h	Local or remote port is occupied by the system.
1	80A3h	Attempt being made to re-establish an existing connection.
1	80A4h	IP address of the remote connection endpoint is invalid.
1	80A7h	Communications error: you have called TDISCON before TCON was complete. TDISCON must first complexly terminate the connection referenced by the ID.
1	80B4h	<p>In the ISO on TCP protocol, one or more of the following conditions have been violated during passive connection setup:</p> <ul style="list-style-type: none"> ■ <i>local_tsap_id_len</i> ≥ 02h ■ <i>local_tsap_id</i>[1] = E0h at <i>local_tsap_id_len</i> = 02h ■ <i>local_tsap_id</i>[1] an ASCII character <i>local_tsap_id_len</i> ≥ 03h ■ <i>local_tsap_id</i>[1] is an ASCII character and <i>local_tsap_id_len</i> ≥ 03h
1	80B5h	Parameter <i>active_est</i> (UDT 65) is TRUE with the protocol variant UDP.
1	80B6h	Parameters <i>connection_type</i> is invalid (UDT 65).

ERROR	STATUS	Description
1	80B7h	Error in one of the following parameters of UDT 65: <ul style="list-style-type: none"> ■ block_length ■ local_tsap_id_len ■ rem_subnet_id_len ■ rem_staddr_len ■ rem_tsap_id_len ■ next_staddr_len
1	80B8h	Parameters <i>id</i> in the local connection description (UDT 65) and parameter ID are different.
1	80C3h	Temporary lack of resources in the CPU.
1	80C4h	Temporary communications error: <ul style="list-style-type: none"> ■ The connection cannot be established at this time. ■ The interface is receiving new parameters.
1	8F7Fh	Internal Error (VIPA specific)
1	8xyyh	General error information ↪ Chap. 4.2 'General and Specific Error Information RET_VAL' page 66

8.1.6 UDT 65 - TCON_PAR Data structure for FB 65

8.1.6.1 Data structure for assigning connection

In the TCP Connection parameterization of native or ISO on TCP, you define which communication partners enabled the connection and which to a request through the communication partner performs a passive connection. If both communication partners have launched their connection, the operating system can restore the communication link. To communicate a DB is needed. Facility whereby the DB's data structure from the UDT 65 TCON_PAR. For each connection such a data structure is needed that can be summarized in a global DB. The CONNECT connection parameter address of FB 65 TCON contains a reference to the associated connection description (e.g. P#DB10.DBX0.0 byte 64).

Data structure

Byte	Parameter	Data type	Start value	Description
0 ... 1	block_length	WORD	40h	Length of UDT 65: 64 bytes (fixed)
2 ... 3	id	WORD	0000h	<ul style="list-style-type: none"> ■ Reference to the connection (range of values: 0001h ... 0FFFh) ■ You must specify the value of the parameter in the respective block with <i>ID</i>.
4	connection_type	BYTE	01h	Connection type: <ul style="list-style-type: none"> ■ 11h: TCP/IP native ■ 12h: ISO on TCP ■ 13h: UDP ■ 01h: TCP/IP native (Compatibility mode)

Byte	Parameter	Data type	Start value	Description
5	active_est	BOOL	FALSE	ID for the way the connection is established: TCP, TCP, IoT: <ul style="list-style-type: none"> ■ FALSE: passive establishment ■ TRUE: active establishment UDP: <ul style="list-style-type: none"> ■ FALSE
6	local_device_id	BYTE	02h	Communication device <ul style="list-style-type: none"> ■ 00h: Ethernet PG/OP channel of the CPU ■ 02h: Ethernet CP of the CPU
7	local_tsap_id_len	BYTE	02h	Length of parameter <i>local_tsap_id</i> used; possible values: TCP <ul style="list-style-type: none"> ■ Active side: 0 (dynamic port) or 2 ■ Passive side: 2 ISO on TCP <ul style="list-style-type: none"> ■ 2 ... 16 UDP <ul style="list-style-type: none"> ■ 2 TCP <ul style="list-style-type: none"> ■ Active side: 0 ■ Passive side: 2
8	rem_subnet_id_len	BYTE	00h	This parameter is currently not used. You must assign 00h to it.
9	rem_staddr_len	BYTE	00h	Length of address for the remote connection transmission point: TCP/ISO on TCP/TCP (Comp.) <ul style="list-style-type: none"> ■ 0: unspecified, i.e. parameter <i>rem_staddr</i> is irrelevant. ■ 4: valid IP address in the parameter <i>rem_staddr</i> UDP <ul style="list-style-type: none"> ■ 0*

Byte	Parameter	Data type	Start value	Description
10	rem_tsap_id_len	BYTE	00h	<p>Length of parameter <i>rem_tsap_id</i> used; possible values:</p> <p>TCP</p> <ul style="list-style-type: none"> ■ Active side: 2 (The port must be specified.) ■ Passive side: 0 or 2 <p>ISO on TCP</p> <ul style="list-style-type: none"> ■ 0 or 2 ... 16 <p>UDP</p> <ul style="list-style-type: none"> ■ This parameter is not used. Assign parameter to 00h. <p>TCP (Comp.)</p> <ul style="list-style-type: none"> ■ Active side: 2 (The port must be specified.) For the passive side, only the value 00h permitted.
11	next_staddr_len	BYTE	00h	<p>Length of parameter <i>next_staddr</i> used</p> <ul style="list-style-type: none"> ■ 00h: Ethernet CP of the CPU ■ 01h: Ethernet PG/OP channel of the CPU
12 ... 27	local_tsap_id	ARRAY [1..16] of BYTE	00h ...	<p>With <i>connection_type</i></p> <p>TCP, UDP</p> <ul style="list-style-type: none"> ■ local_tsap_id[1] = high byte of port number in hexadecimal representation ■ local_tsap_id[2] = low byte of port number in hexadecimal representation ■ local_tsap_id[3-16] = 00h <p>ISO on TCP</p> <ul style="list-style-type: none"> ■ local TSAP-ID (possible values: 2000 ... 5000) <ul style="list-style-type: none"> – local_tsap_id[1] = E0h (connection type T-connection) – local_tsap_id[2] = Rack and slot in own CPU (bits 0 ... 4 slot, bits 5 ... 7: rack number) – local_tsap_id[3-16] = TSAP extension <p>TCP (Comp.)</p> <ul style="list-style-type: none"> ■ local_tsap_id[1] = low byte of port number in hexadecimal representation ■ local_tsap_id[2] = high byte of port number in hexadecimal representation ■ local_tsap_id[3-16] = 00h <p>Note: Make sure that each value of <i>local_tsap_id</i> that you use in your CPU is unique.</p>
28 ... 33	rem_subnet_id	ARRAY [1..6] of BYTE	00h ...	<p>This parameter is currently not used. You must assign 00h to it.</p>

Byte	Parameter	Data type	Start value	Description
34 ... 39	rem_staddr	ARRAY [1..6] of BYTE	00h ...	<p>IP address for the remote connection transmission point: e.g. 192.168.002.003: With <i>connection_type</i></p> <ul style="list-style-type: none"> ■ TCP / ISO on TCP <ul style="list-style-type: none"> – rem_staddr[1] = C0h (192) – rem_staddr[2] = A8h (168) – rem_staddr[3] = 02h (002) – rem_staddr[4] = 03h (003) – rem_staddr[5-6] = irrelevant ■ UDP <ul style="list-style-type: none"> – This parameter is not used. Assign parameter to 00h. ■ TCP (Comp.) <ul style="list-style-type: none"> – rem_staddr[1] = 03h (003) – rem_staddr[2] = 02h (002) – rem_staddr[3] = A8h (168) – rem_staddr[4] = C0h (192) – rem_staddr[5-6] = irrelevant
40 ... 55	rem_tsap_id	ARRAY [1..16] of BYTE	00h ...	<p>With <i>connection_type</i></p> <ul style="list-style-type: none"> ■ TCP: remote port number (possible values: 2000 ... 5000) <ul style="list-style-type: none"> – rem_tsap_id[1] = high byte of port no in hexadecimal representation – rem_tsap_id[2] = low byte of port no in hexadecimal representation – rem_tsap_id[3-16] = 00h ■ ISO on TCP: remote TSAP-ID: <ul style="list-style-type: none"> – rem_tsap_id[1] = E0h (connection type T-connection) – rem_tsap_id[2] = Rack and slot for the remote connection transmission point CPU (bits 0 ... 4: slot, bits 5 ... 7: rack number), – rem_tsap_id[3-16] = TSAP extension ■ UDP <p>This parameter is not used. Assign parameter to 00h</p> ■ 01h: remote port number (possible values: 2000 ... 5000) <ul style="list-style-type: none"> – local_tsap_id[1] = low byte of port number in hexadecimal representation – local_tsap_id[2] = high byte of port number in hexadecimal representation – local_tsap_id[3-16] = 00h
56 ... 61	next_staddr	ARRAY [1..6] of BYTE	00h ...	<p>Rack and slot of the configured CP for the PG/OP interface</p> <ul style="list-style-type: none"> ■ 00h (Ethernet P/OP channel) <ul style="list-style-type: none"> – next_staddr[1]: 04h – next_staddr[2-6]: 00h ■ 02h (Ethernet CP) <ul style="list-style-type: none"> – next_staddr[1-6]: 00h

Open Communication > UDT 65 - TCON_PAR Data structure for FB 65

Byte	Parameter	Data type	Start value	Description
62 ... 63	spare	WORD	0000h	irrelevant

*) The partner IP address is specified by calling the TUSEND/TURECV parameter via the ADDR parameter.

8.1.6.2 Data structure for communications access point

A communications access point provides the link between application of the communication layer of the operating system. Defined for communication over UDP, each communication partner a communication access point using a DB. Facility whereby the DB's data structure from the UDT 65 "TCON_PAR".

Data structure

Byte	Parameter	Data type	Start value	Description
0 ... 1	block_length	WORD	40h	Length of UDT 65: 64 Bytes (fixed)
2 ... 3	id	WORD	0000h	<ul style="list-style-type: none"> ■ Reference to this connection between the user program and the communications level of the operating system (range of values: 0001h ... 0FFFh) ■ You must specify the value of the parameter in the respective block with the ID.
4	connection_type	BYTE	01h	Connection type: <ul style="list-style-type: none"> ■ 13h: UDP
5	active_est	BOOL	FALSE	ID for the way the connection is established: You must assign FALSE to this parameter since the communications access point can be used to both send and receive data.
6	local_device_id	BYTE	02h	Communication device <ul style="list-style-type: none"> ■ 00h: Ethernet PG/OP channel of the CPU ■ 02h: Ethernet CP of the CPU
7	local_tsap_id_len	BYTE	02h	Length of parameter local_tsap_id used; possible value: 2
8	rem_subnet_id_len	BYTE	00h	This parameter is currently not used. Value 00h (fix).
9	rem_staddr_len	BYTE	00h	This parameter is currently not used. Value 00h (fix).
10	rem_tsap_id_len	BYTE	00h	This parameter is currently not used. Value 00h (fix).
11	next_staddr_len	BYTE	00h	This parameter is currently not used. Value 00h (fix).

Byte	Parameter	Data type	Start value	Description
12 ... 27	local_tsap_id	ARRAY [1..16] of BYTE	00h ...	<ul style="list-style-type: none"> Remote port number (possible values: 2000 ... 5000), local_tsap_id[1] = high byte of port no in hexadecimal representation, local_tsap_id[2] = low byte of port no in hexadecimal representation, local_tsap_id[3-16] = irrelevant <p>Note: Make sure that each value of <i>local_tsap_id</i> that you use in your CPU is unique.</p>
28 ... 33	rem_subnet_id	ARRAY [1..6] of BYTE	00h ...	This parameter is currently not used. Value 00h (fix).
34 ... 39	rem_staddr	ARRAY [1..6] of BYTE	00h ...	This parameter is currently not used. Value 00h (fix).
40 ... 55	rem_tsap_id	ARRAY [1..16] of BYTE	00h ...	This parameter is currently not used. Value 00h (fix).
56 ... 61	next_staddr	ARRAY [1..6] of BYTE	00h ...	This parameter is currently not used. Value 00h (fix).
62 ... 63	spare	WORD	0000h	irrelevant

8.1.7 FB 66 - TDISCON - Terminating a connection

Use with TCP native and ISO on TCP

FB 66 TDISCON terminates a communications connection from the CPU to a communications partner.

Use with UDP

The FB 66 TDISCON closes the local communications access point. The connection between the user program and the communications level of the operating system is terminated.

Description

FB 66 TDISCON is an asynchronously functioning FB, which means that its processing extends over several FB calls. To start terminating a connection, call FB 66 with REQ = 1.

After FB 66 TDISCON has been successfully called, the ID specified for FB 65 TCON is no longer valid and thus cannot be used for sending or receiving.

The job status is indicated at the output parameters *RET_VAL* and *BUSY*. *STATUS* corresponds to the *RET_VAL* output parameter of asynchronously functioning SFCs (see also Meaning of the Parameters REQ, RET_VAL and BUSY with asynchronous SFCs).

The following table shows the relationships between *BUSY*, *DONE* and *ERROR*. Using this table, you can determine the current status of FB 66 or when the establishment of the connection is complete.

BUSY	DONE	ERROR	Description
TRUE	irrelevant	irrelevant	The job is being processed.
FALSE	TRUE	FALSE	The job was completed successfully.

Open Communication > FB 66 - TDISCON - Terminating a connection

BUSY	DONE	ERROR	Description
FALSE	FALSE	TRUE	The job was ended with an error. The cause of the error can be found in the <i>STATUS</i> parameter.
FALSE	FALSE	FALSE	The FB was not assigned a (new) job.

Parameters

Parameter	Declaration	Data type	Memory area	Description
REQ	INPUT	BOOL	I, Q, M, D, L	Control parameter <i>REQ</i> , initiates terminating the connection specified by the <i>ID</i> . Initiation occurs at rising edge.
ID	INPUT	WORD	M, D, constant	Reference to the connection to be terminated to the remote partner or between the user program and the communications level of the operating system. <i>ID</i> must be identical to the associated parameter <i>ID</i> in the local connection description. Range of values: 0001h ... 0FFFh
DONE	OUTPUT	BOOL	I, Q, M, D, L	<i>DONE</i> status parameter: <ul style="list-style-type: none"> ■ 0: Job not yet started or still running. ■ 1: Job executed without error.
BUSY	OUTPUT	BOOL	I, Q, M, D, L	<ul style="list-style-type: none"> ■ <i>BUSY</i> = 1: Job is not yet completed ■ <i>BUSY</i> = 0: Job is completed.
ERROR	OUTPUT	BOOL	I, Q, M, D, L	ERROR status parameter: <ul style="list-style-type: none"> ■ <i>ERROR</i> = 1: Error occurred during processing. <i>STATUS</i> provides detailed information on the type of error.
STATUS	OUTPUT	WORD	M, D	<i>STATUS</i> parameter: Status information

Status information

ERROR	STATUS	Description
0	0000h	Connection is terminated
0	7000h	First call with <i>REQ</i> = 0, establishment of connection not initiated
0	7001h	First call with <i>REQ</i> = 1, start of the processing, connection being terminated
0	7002h	Follow-on call (<i>REQ</i> irrelevant), connection being terminated
1	8086h	The ID parameter is not in the permitted address range
1	80A3h	Attempt being made to terminate a non-existent connection
1	80C4h	Temporary communications error: The interface is receiving new parameters.
1	8F7Fh	Internal Error (VIPa specific)
1	8xyyh	General error information ↪ Chap. 4.2 'General and Specific Error Information RET_VAL' page 66

8.1.8 FB 67 - TUSEND - Sending data - UDP

Description

FB 67 TUSEND sends data via UDP to the remote partner specified by the parameter *ADDR*.



*When sending separate data in sequence to different partners, you only need to adjust the parameter *ADDR* when calling FB 67 TUSEND. It is not necessary to call FB 65 TCON and FB 66 TDISCON again.*

Function

- FB 67 TUSEND is an asynchronously functioning FB, which means that its processing extends over several FB calls. To start sending data, call FB 67 with *REQ* = 1.
- The job status is indicated at the output parameters *BUSY* and *STATUS*. *STATUS* corresponds to the *RET_VAL* output parameter of asynchronously functioning SFCs (see also Meaning of the Parameters *REQ*, *RET_VAL* and *BUSY* with asynchronous SFCs).
- The following table shows the relationships between *BUSY*, *DONE* and *ERROR*. Using this table, you can determine the current status of FB 67 or when the sending process (transmission) is complete.

BUSY	DONE	ERROR	Description
TRUE	irrelevant	irrelevant	The job is being processed.
FALSE	TRUE	FALSE	The job was completed successfully.
FALSE	FALSE	TRUE	The job was ended with an error. The cause of the error can be found in the <i>STATUS</i> parameter.
FALSE	FALSE	FALSE	The FB was not assigned a (new) job.



*Due to the asynchronous function of FB 67 TUSEND, you must keep the data in the sender area consistent until the *DONE* parameter or the *ERROR* parameter assumes the value TRUE.*

Parameters

Parameter	Declaration	Data type	Memory area	Description
REQ	INPUT	BOOL	I, Q, M, D, L	Control parameter <i>REQ</i> , initiates the transmission at rising edge. At the first call with <i>REQ</i> = 1, bytes are transmitted from the area specified by the <i>DATA</i> parameter.
ID	INPUT	WORD	M, D, constant	Reference to the associated connection between the user program and the communication level of the operating system. <i>ID</i> must be identical to the associated parameter <i>ID</i> in the local connection description. Range of values: 0001h ... 0FFFh

Open Communication > FB 67 - TUSEND - Sending data - UDP

Parameter	Declaration	Data type	Memory area	Description
LEN	INPUT	INT	I, Q, M, D, L	Number of bytes to be sent with the job: Range of values: 1 ... 1460
DONE	OUTPUT	BOOL	I, Q, M, D, L	<i>DONE</i> status parameter: <ul style="list-style-type: none"> ■ 0: Job not yet started or still running ■ 1: Job executed without error.
BUSY	OUTPUT	BOOL	I, Q, M, D, L	<ul style="list-style-type: none"> ■ <i>BUSY</i> = 1: Job is not yet completed. A new job cannot be triggered. ■ <i>BUSY</i> = 0: Job is completed.
ERROR	OUTPUT	BOOL	I, Q, M, D, L	ERROR status parameter: <ul style="list-style-type: none"> ■ <i>ERROR</i> = 1: Error occurred during processing. <i>STATUS</i> provides detailed information on the type of error
STATUS	OUTPUT	WORD	M, D	<i>STATUS</i> parameter: Error information
DATA	IN_OUT	ANY	I, Q, M, D	Sender area, contains address and length The address refers to: <ul style="list-style-type: none"> ■ The process image input table ■ The process image output table ■ A bit memory ■ A data block Allowed referenced data types: BOOL, BYTE, CHAR, WORD, INT, DWORD, DINT, REAL, DATE, TIME_OF_DAY, TIME, S5TIME, DATE_AND_TIME, STRING
ADDR	IN_OUT	ANY	D	Pointer to the address of the receiver (e.g. P#DB100.DBX0.0 byte 8), see Structure of the Address Information for the Remote Partner with UDP.

Error information

ERROR	STATUS	Description
0	0000h	Send job completed without error.
0	7000h	First call with <i>REQ</i> = 1, sending not initiated.
0	7001h	First call with <i>REQ</i> = 1, sending initiated.
0	7002h	Follow-on call (<i>REQ</i> irrelevant), job being processed Note: during this processing the operating system accesses the data in the <i>DATA</i> send buffer.
1	8085h	<i>LEN</i> parameter has the value 0 or is greater than the largest permitted value.
1	8086h	The <i>ID</i> parameter is not in the permitted address range.
0	8088h	<i>LEN</i> parameter is larger than the memory area specified in <i>DATA</i> .
1	8089h	Parameter <i>ADDR</i> does not point to a data block.

ERROR	STATUS	Description
1	80A1h	Communications error: <ul style="list-style-type: none"> ■ FB 65 TCON was not yet called for the specified <i>ID</i> ■ The specified connection between the user program and the communication level of the operating system is currently being terminated. Transmission over this connection is not possible. ■ The interface is being reinitialized (receiving new parameters).
1	80A4h	The IP address of the communication partner is not valid.
1	80B3h	<ul style="list-style-type: none"> ■ The parameter for the connection type (<i>connection_type</i> parameter in the connection description) is not set to UDP. Please use the FB 63 TSEND. ■ Parameter <i>ADDR</i>: invalid port number or IP address.
1	80B7h	Length error: The parameter <i>ADDR</i> is the length specification < 8byte.
1	80C4h	Temporary communications error: <ul style="list-style-type: none"> ■ The communication partner is currently not available. ■ The connection is currently being configured (or TCON is still running).
1	8822h	<i>DATA</i> parameter: Source area invalid: area does not exist in DB.
1	8824h	<i>DATA</i> parameter: Range error in ANY pointer.
1	8832h	<i>DATA</i> parameter: DB number too large.
1	883Ah	<i>DATA</i> parameter: Access to send buffer not possible (e.g. due to deleted DB).
1	887Fh	<i>DATA</i> parameter: Internal error, e.g. an invalid ANY reference.
1	8F7Fh	Internal Error (VIPA specific)
1	8xyyh	General error information ↗ <i>Chap. 4.2 'General and Specific Error Information RET_VAL' page 66</i>

8.1.9 FB 68 - TURCV - Receiving data - UDP

Description

- FB 68 TURCV receives data via UDP. After successful completion of FB 68 TURCV the parameter *ADDR* will show you the address of the remote partner (the sender).
- FB 68 TURCV is an asynchronously functioning FB, which means that its processing extends over several FB calls. To start sending data, call FB 68 with *REQ* = 1.
- The job status is indicated at the output parameters *RET_VAL* and *BUSY*. *STATUS* corresponds to the *RET_VAL* output parameter of asynchronously functioning SFCs (see also Meaning of the Parameters *REQ*, *RET_VAL* and *BUSY* with asynchronous SFCs).
- The following table shows the relationships between *BUSY*, *NDR* and *ERROR*. Using this table, you can determine the current status of FB 68 or when the receiving process is complete.

BUSY	NDR	ERROR	Description
TRUE	irrelevant	irrelevant	The job is being processed.
FALSE	TRUE	FALSE	The job was completed successfully.

BUSY	NDR	ERROR	Description
FALSE	FALSE	TRUE	The job was ended with an error. The cause of the error can be found in the <i>STATUS</i> parameter.
FALSE	FALSE	FALSE	The FB was not assigned a (new) job.



Due to the asynchronous function of FB 68 TURCV, the data in the receiver area are only consistent when the NDR parameter assumes the value TRUE.

Parameters

Parameter	Declaration	Data type	Memory area	Description
EN_R	INPUT	BOOL	I, Q, M, D, L	Control parameter enabled to receive: when <i>EN_R</i> = 1, FB 68 TURCV is ready to receive.
ID	INPUT	WORD	M, D, constant	Reference to the associated connection between the user program and the communication level of the operating system. <i>ID</i> must be identical to the associated parameter <i>ID</i> in the local connection description. Range of values: 0001h ... 0FFFh
LEN	INPUT	INT	I, Q, M, D, L	$1 \leq LEN \leq 1472$: number of bytes to be received. The received data are immediately available when the block is called. The amount of data received is available in <i>RCVD_LEN</i> .
NDR	OUTPUT	BOOL	I, Q, M, D, L	NDR status parameter: <ul style="list-style-type: none"> ■ <i>NDR</i> = 0: Job not yet started or still running. ■ <i>NDR</i> = 1: Job successfully completed
ERROR	OUTPUT	BOOL	I, Q, M, D, L	<i>ERROR</i> status parameter: <ul style="list-style-type: none"> ■ <i>ERROR</i> = 1: Error occurred during processing. <i>STATUS</i> provides detailed information on the type of error
BUSY	OUTPUT	BOOL	I, Q, M, D, L	<ul style="list-style-type: none"> ■ <i>BUSY</i> = 1: Job is not yet completed. A new job cannot be triggered. ■ <i>BUSY</i> = 0: Job is completed.
STATUS	OUTPUT	WORD	M, D	Status parameter: Error information
RCVD_LEN	OUTPUT	INT	I, Q, M, D, L	Amount of data actually received, in bytes

Parameter	Declaration	Data type	Memory area	Description
DATA	IN_OUT	ANY	I, Q, M, D	Receiver area, contains address and length The address refers to: <ul style="list-style-type: none"> ■ The process image input table ■ The process image output table ■ A bit memory ■ A data block Allowed referenced data types: BOOL, BYTE, CHAR, WORD, INT, DWORD, DINT, REAL, DATE, TIME_OF_DAY, TIME, S5TIME, DATE_AND_TIME, STRING
ADDR	IN_OUT	ANY	D	Pointer to the address of the sender (e.g. P#DB100.DBX0.0 byte 8), see Structure of the Address Information for the Remote Partner with UDP

Error information

ERROR	STATUS	Description
0	0000h	New data were accepted. The current length of the received data is shown in <i>RCVD_LEN</i> .
0	7000h	First call with <i>REQ</i> = 0, receiving not initiated
0	7001h	Block is ready to receive.
0	7002h	Follow-on call, job being processed Note: during this processing the operating system writes the operating system data to the <i>DATA</i> receive buffer. For this reason, an error could result in inconsistent data being in the receive buffer.
1	8085h	<i>LEN</i> parameter is greater than the largest permitted value, or you changed the value of <i>LEN</i> from the one that existed during the first call
1	8086h	The <i>ID</i> parameter is not in the permitted address range
1	8088h	<ul style="list-style-type: none"> ■ Target buffer (<i>DATA</i>) is too small. ■ The value in <i>LEN</i> is greater than the receiver area specified by <i>DATA</i>.
1	8089h	Parameter <i>ADDR</i> does not point to a data block.
1	80A1h	Communications error: <ul style="list-style-type: none"> ■ FB 65 TCON was not yet called for the specified <i>ID</i> ■ The specified connection between the user program and the communication level of the operating system is currently being terminated. Receiving over this connection is not possible. ■ The interface is being reinitialized (receiving new parameters).
1	80B3h	The parameter for the connection type (connection_type parameter in the connection description) is not set to UDP. Please use the FB 64 TRCV.
1	80B7h	Length error: The parameter <i>ADDR</i> is the length specification < 8byte.
1	80C4h	Temporary communications error: <ul style="list-style-type: none"> ■ The connection is currently being configured (or TCON is still running).

ERROR	STATUS	Description
1	8922h	DATA parameter: Target area invalid: area does not exist in DB.
1	8924h	DATA parameter: Range error in ANY pointer
1	8932h	DATA parameter: DB number too large.
1	893Ah	DATA parameter: Access to receive buffer not possible (e.g. deleted DB)
1	897Fh	DATA parameter: Internal error, such as an invalid ANY reference
1	8F7Fh	Internal Error (VIPA specific)
1	8xyyh	General error information ↗ Chap. 4.2 'General and Specific Error Information RET_VAL' page 66

8.1.10 UDT 66 - TADDR_PAR Data structure

8.1.10.1 Data structure for assigning connection

Description

- With FB 67 TUSEND, at the parameter *ADDR* you transfer the address of the receiver. This address information must have structure specified below.
- With FB 68 TURCV, in the parameter *ADDR* you get the address of the sender of the data that were received. This address information must have structure specified below.

Data block

You have to create an DB that contains one or more data structures as per UDT 66 TADDR_PAR.

In parameter *ADDR* of FB 67 TUSEND you transfer and in parameter *ADDR* of FB 68 TURCV you receive a pointer to the address of the associated remote partner (e.g. P#DB10.DBX0.0 byte 8).

Structure of the address information for the remote partner

Byte	Parameter	Data type	Start value	Description
0 ... 3	rem_ip_addr	ARRAY [1..4] of BYTE	00h ...	IP address of the remote partner, e.g. 192.168.002.003: <ul style="list-style-type: none"> ■ rem_ip_addr[1] = C0h (192) ■ rem_ip_addr[2] = A8h (168) ■ rem_ip_addr[3] = 02h (002) ■ rem_ip_addr[4] = 03h (003)
4 ... 5	rem_port_nr	ARRAY [1..2] of BYTE	00h ...	remote port number (possible values: 2000 ... 5000) <ul style="list-style-type: none"> ■ rem_port_nr[1] = high byte of port number in hexadecimal representation ■ rem_port_nr[2] = low byte of port number in hexadecimal representation
6 ... 7	spare	ARRAY [1..2] of BYTE	00h ...	reserved (00h)

8.2 Ethernet Communication

8.2.1 Communication - FC 5...6 for CP 343

The two blocks are used to process connection requests on the PLC side of an Ethernet CP 343. Through integration of these blocks in the cycle block OB1 you may cyclically send and receive data. Within these blocks, the SFCs 205 and 206 are called that are stored as special function blocks in the CPU.



Please regard that you may only use the SEND/RCV-FCs from VIPA in your user application for the communication with VIPA CPs. At a change to VIPA CPs in an already existing project, the present AG_SEND / AG_LSEND res. AG_RECV / AG_LRCV may be replaced by AG_SEND res. AG_RECV from VIPA without adaptation. Due to the fact that the CP automatically adjusts itself to the length of the data to transfer, the L variant of SEND res. RCV is not required for VIPA CPs.

Communication blocks

For the communication between CPU and Ethernet-CP 343, the following FCs are available:

- AG_SEND (FC 5)
 - This block transfers the user data from the data area given in *SEND* to the CP specified via *ID* and *LADDR*. As data area you may set a PI, bit memory or data block area. When the data area has been transferred without errors, "job ready without error" is returned.
- AG_RECV (FC 6)
 - The block transfers the user data from the CP into a data area defined via *RCV*. As data area you may set a PI, bit memory or data block area. When the data area has been transferred without errors, "job ready without error" is returned.

Status displays

The CP processes send and receive commands independently from the CPU cycle and needs for this transfer time. The interface with the FC blocks to the user application is here synchronized by means of acknowledgements/receipts. For status evaluation the communication blocks return parameters that may be evaluated directly in the user application. These status displays are updated at every block call.

Deployment at high communication load

Do not use cyclic calls of the communication blocks in OB 1. This causes a permanent communication between CPU and CP. Program instead the communication blocks within a time OB where the cycle time is higher OB 1 res. event controlled.

FC call is faster than CP transfer time

If a block is called a second time in the user application before the data of the last time is already completely send res. received, the FC block interface reacts like this:

- AG_SEND
 - No command is accepted until the data transfer has been acknowledged from the partner via the connection. Until this you receive the message "Order running" before the CP is able to receive a new command for this connection.
- AG_RECV
 - The job is acknowledged with the message "No data available yet" as long as the CP has not received the receive data completely.

AG_SEND, AG_RECV in user application

The following illustration shows a possible sequence for the FC blocks together with the organizations and program blocks in the CPU cycle:

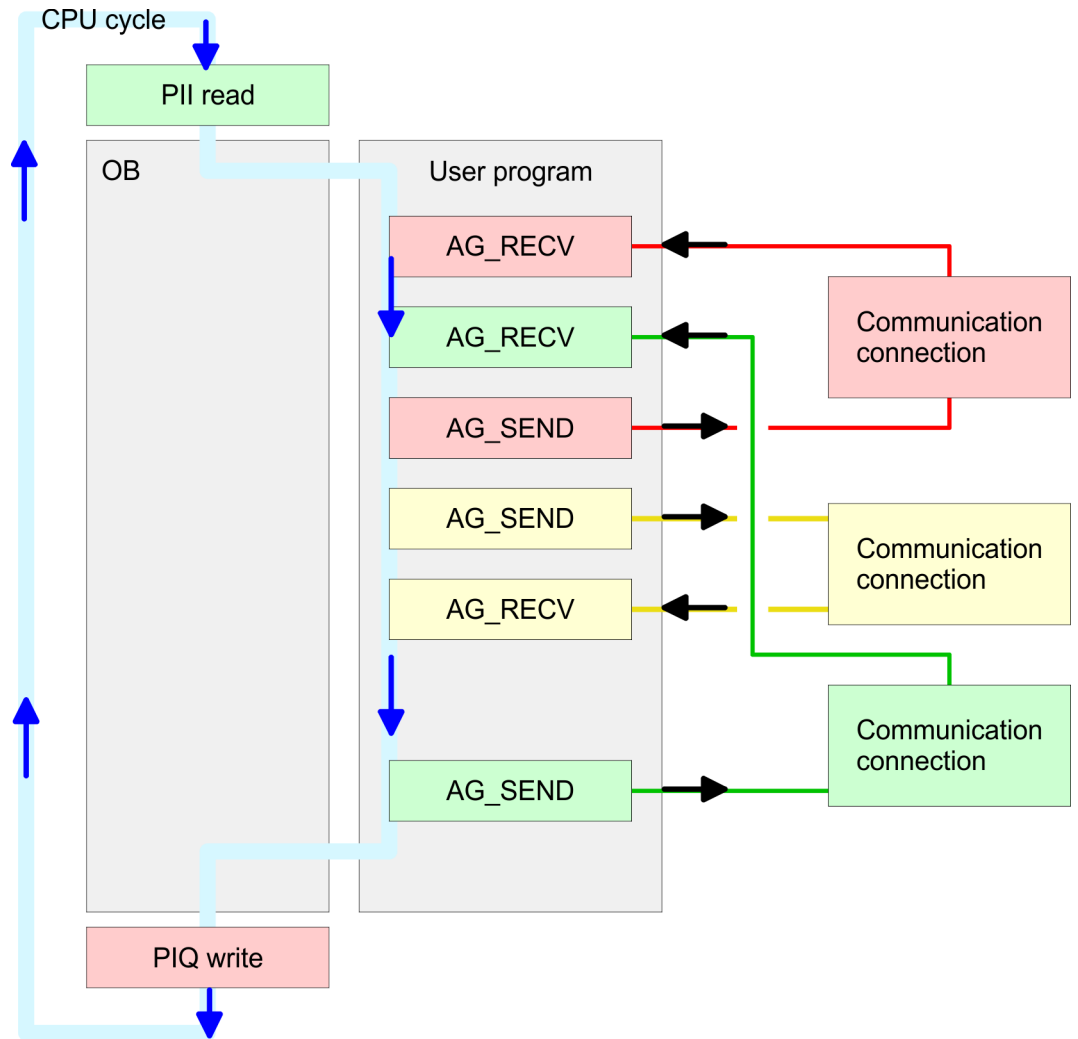

The FC blocks with concerning communication connection are grouped by color. Here you may also see that your user application may consist of any number of blocks. This allows you to send or receive data (with AG_SEND res. AG_RECV) event or program driven at any wanted point within the CPU cycle. You may also call the blocks for **one** communication connection several times within one cycle.

8.2.2 FC 5 - AG_SEND - Send to CP 343

By means of AG_SEND the data to send are transferred from the CPU to an Ethernet CP.



Please note that this block calls the FC or SFC 205 AG_SEND internally. These must not be overwritten! The direct call of an internal block leads to errors in the corresponding instance DB!

Parameter

Parameter	Declaration	Data type	Description
ACT	INPUT	BOOL	Activation of the sender 0: Updates <i>DONE</i> , <i>ERROR</i> and <i>STATUS</i> 1: The data area defined in <i>SEND</i> with the length <i>LEN</i> is send
ID	INPUT	INT	Connection number 1 ... 16 (identical with <i>ID</i> of NetPro)
LADDR	INPUT	WORD	Logical basic address of the CP (identical with <i>LADDR</i> of NetPro)
SEND	INPUT	ANY	Data area
LEN	INPUT	INT	Number of bytes from data area to transfer
DONE	OUTPUT	BOOL	Status parameter for the job 0: Job running 1: Job finished without error.
ERROR	OUTPUT	BOOL	Error message 0: Job running (at <i>DONE</i> = 0) 0: Job ready without error (at <i>DONE</i> = 1) 1: Job ready with error
STATUS	OUTPUT	WORD	Status message returned with <i>DONE</i> and <i>ERROR</i> . More details are to be found in the following table.

DONE, ERROR, STATUS

The following table shows all messages that can be returned by the Ethernet CP after a SEND res. RECV job. A "-" means that this message is not available for the concerning SEND res. RECV command.

DONE (SEND)	NDR (RECV)	ERROR	STATUS	Description
1	-	0	0000h	Job finished without error.
-	1	0	0000h	New data taken without error.
0	-	0	0000h	There is no job being executed
-	0	0	8180h	No data available yet.
0	0	0	8181h	Job running
0	0	1	8183h	No CP project engineering for this job.

DONE (SEND)	NDR (RECV)	ERROR	STATUS	Description
0	-	1	8184h	System error occurred
-	0	1	8184h	System error occurred (source data area failure).
0	-	1	8185h	Parameter <i>LEN</i> exceeds source area <i>SEND</i> .
	0	1	8185h	Destination buffer (RECV) too small.
0	0	1	8186h	Parameter <i>ID</i> invalid (not within 1 ...16).
0	-	1	8302h	No receive resources at destination station, receive station is not able to process received data fast enough res. has no receive resources reserved.
0	-	1	8304h	The connection is not established. The send command shouldn't be sent again before a delay time of > 100ms.
-	0	1	8304h	The connection is not established. The receive command shouldn't be sent again after a delay time of > 100ms.
0	-	1	8311h	Destination station not available under the defined Ethernet address.
0	-	1	8312h	Ethernet error in the CP.
0		1	8F22h	Source area invalid, e.g. when area in DB not present Parameter <i>LEN</i> < 0
-	0	1	8F23h	Source area invalid, e.g. when area in DB not present Parameter <i>LEN</i> < 0
0	-	1	8F24h	Range error at reading a parameter.
-	0	1	8F25h	Range error at writing a parameter.
0	-	1	8F28h	Orientation error at reading a parameter.
-	0	1	8F29h	Orientation error at writing a parameter.
-	0	1	8F30h	Parameter is within write protected 1. recent data block
-	0	1	8F31h	Parameter is within write protected 2. recent data block Data block
0	0	1	8F32h	Parameter contains oversized DB number.
0	0	1	8F33h	DB number error
0	0	1	8F3Ah	Area not loaded (DB)
0	-	1	8F42h	Acknowledgement delay at reading a parameter from peripheral area.
-	0	1	8F43h	Acknowledgement delay at writing a parameter from peripheral area.
0	-	1	8F44h	Address of the parameter to read locked in access track
-	0	1	8F45h	Address of the parameter to write locked in access track
0	0	1	8F7Fh	Internal error e.g. invalid ANY reference e.g. parameter <i>LEN</i> = 0.
0	0	1	8090h	Module with this module start address not present or CPU in STOP.

DONE (SEND)	NDR (RCV)	ERROR	STATUS	Description
0	0	1	8091h	Module start address not within double word grid.
0	0	1	8092h	ANY reference contains type setting unequal BYTE.
-	0	1	80A0h	Negative acknowledgement at reading from module.
0	0	1	80A4h	reserved
0	0	1	80B0h	Module doesn't recognize the record set.
0	0	1	80B1h	The length setting (in parameter <i>LEN</i>) is invalid.
0	0	1	80B2h	reserved
0	0	1	80C0h	Record set not readable.
0	0	1	80C1h	The set record set is still in process.
0	0	1	80C2h	There is a job jam.
0	0	1	80C3h	The operating sources (memory) of the CPU are temporarily occupied.
0	0	1	80C4h	Communication error (occurs temporarily; a repetition in the user application is reasonable).
0	0	1	80D2h	Module start address is wrong.

Status parameter at reboot At a reboot of the CP, the output parameters are set as follows:

- DONE = 0
- NDR = 0
- ERROR = 0
- STATUS = 8180h (at AG_RECV)
- STATUS = 8181h (at AG_SEND)

8.2.3 FC 6 - AG_RECV - Receive from CP 343

With the 1. call of AG_RECV a receive buffer for the communication between CPU and an Ethernet CP 343 is established. From now on received data are automatically stored in this buffer. As soon as after calling AG_RECV the return value of *NDR* = 1 is returned, valid data are present. Since with a further call of AG_RECV the receive buffer is established again for the receipt of new data, you have to save the previous received data.



Please note that this block calls the FC or SFC 206 AG_RECV internally. These must not be overwritten! The direct call of an internal block leads to errors in the corresponding instance DB!

Parameter

Parameter	Declaration	Data type	Description
ID	INPUT	INT	Connection number 1 ... 16 (identical with <i>ID</i> of NetPro)
LADDR	INPUT	WORD	Logical base address of the CP (identical with <i>LADDR</i> of NetPro)
RECV	INPUT	ANY	Data area for the received data.
NDR	OUTPUT	BOOL	Status parameter for the order 0: Order running 1: Order ready data received without error
ERROR	OUTPUT	BOOL	Error message 0: Order running (at <i>NDR</i> = 0) 0: Order ready without error (at <i>NDR</i> = 1) 1: Order ready with error
STATUS	OUTPUT	WORD	Status message returned with <i>NDR</i> and <i>ERROR</i> . More details are to be found in the following table.
LEN	OUTPUT	INT	Number of bytes that have been received

DONE, ERROR, STATUS

The following table shows all messages that can be returned by the Ethernet CP after a SEND res. RECV job. A "-" means that this message is not available for the concerning SEND res. RECV command.

DONE (SEND)	NDR (RECV)	ERROR	STATUS	Description
1	-	0	0000h	Job finished without error.
-	1	0	0000h	New data taken without error.
0	-	0	0000h	There is no job being executed
-	0	0	8180h	No data available yet.
0	0	0	8181h	Job running
0	0	1	8183h	No CP project engineering for this job.

DONE (SEND)	NDR (RECV)	ERROR	STATUS	Description
0	-	1	8184h	System error occurred
-	0	1	8184h	System error occurred (source data area failure).
0	-	1	8185h	Parameter <i>LEN</i> exceeds source area <i>SEND</i> .
	0	1	8185h	Destination buffer (RECV) too small.
0	0	1	8186h	Parameter <i>ID</i> invalid (not within 1 ...16).
0	-	1	8302h	No receive resources at destination station, receive station is not able to process received data fast enough res. has no receive resources reserved.
0	-	1	8304h	The connection is not established. The send command shouldn't be sent again before a delay time of > 100ms.
-	0	1	8304h	The connection is not established. The receive command shouldn't be sent again after a delay time of > 100ms.
0	-	1	8311h	Destination station not available under the defined Ethernet address.
0	-	1	8312h	Ethernet error in the CP.
0		1	8F22h	Source area invalid, e.g. when area in DB not present Parameter <i>LEN</i> < 0
-	0	1	8F23h	Source area invalid, e.g. when area in DB not present Parameter <i>LEN</i> < 0
0	-	1	8F24h	Range error at reading a parameter.
-	0	1	8F25h	Range error at writing a parameter.
0	-	1	8F28h	Orientation error at reading a parameter.
-	0	1	8F29h	Orientation error at writing a parameter.
-	0	1	8F30h	Parameter is within write protected 1. recent data block
-	0	1	8F31h	Parameter is within write protected 2. recent data block Data block
0	0	1	8F32h	Parameter contains oversized DB number.
0	0	1	8F33h	DB number error
0	0	1	8F3Ah	Area not loaded (DB)
0	-	1	8F42h	Acknowledgement delay at reading a parameter from peripheral area.
-	0	1	8F43h	Acknowledgement delay at writing a parameter from peripheral area.
0	-	1	8F44h	Address of the parameter to read locked in access track
-	0	1	8F45h	Address of the parameter to write locked in access track
0	0	1	8F7Fh	Internal error e.g. invalid ANY reference e.g. parameter <i>LEN</i> = 0.
0	0	1	8090h	Module with this module start address not present or CPU in STOP.

DONE (SEND)	NDR (RECV)	ERROR	STATUS	Description
0	0	1	8091h	Module start address not within double word grid.
0	0	1	8092h	ANY reference contains type setting unequal BYTE.
-	0	1	80A0h	Negative acknowledgement at reading from module.
0	0	1	80A4h	reserved
0	0	1	80B0h	Module doesn't recognize the record set.
0	0	1	80B1h	The length setting (in parameter <i>LEN</i>) is invalid.
0	0	1	80B2h	reserved
0	0	1	80C0h	Record set not readable.
0	0	1	80C1h	The set record set is still in process.
0	0	1	80C2h	There is a job jam.
0	0	1	80C3h	The operating sources (memory) of the CPU are temporarily occupied.
0	0	1	80C4h	Communication error (occurs temporarily; a repetition in the user application is reasonable).
0	0	1	80D2h	Module start address is wrong.

Status parameter at reboot At a reboot of the CP, the output parameters are set as follows:

- DONE = 0
- NDR = 0
- ERROR = 0
- STATUS = 8180h (at AG_RECV)
- STATUS = 8181h (at AG_SEND)

8.2.4 FC 10 - AG_CNTRL - Control CP 343

Description

The connections of the Ethernet CP 343 may be diagnosed and initialized by means of the VIPA FC 10.

The following jobs may be executed by parameterizable commands:

- Reading connection information
- Resetting configured connections

The commands of this block are permitted only for SEND/RECV connections based on the ISO/RFC/TCP and UDP protocols.



Please note that this block calls the FC or SFC 196 AG_CNTRL internally. These must not be overwritten! The direct call of an internal block leads to errors in the corresponding instance DB!

FC 10 in the user program

The following diagram shows a typical sequence of AG_CNTRL. Here it is shown how the connection status is initially queried and then, in a second job, how the connection termination is triggered with the rest command.

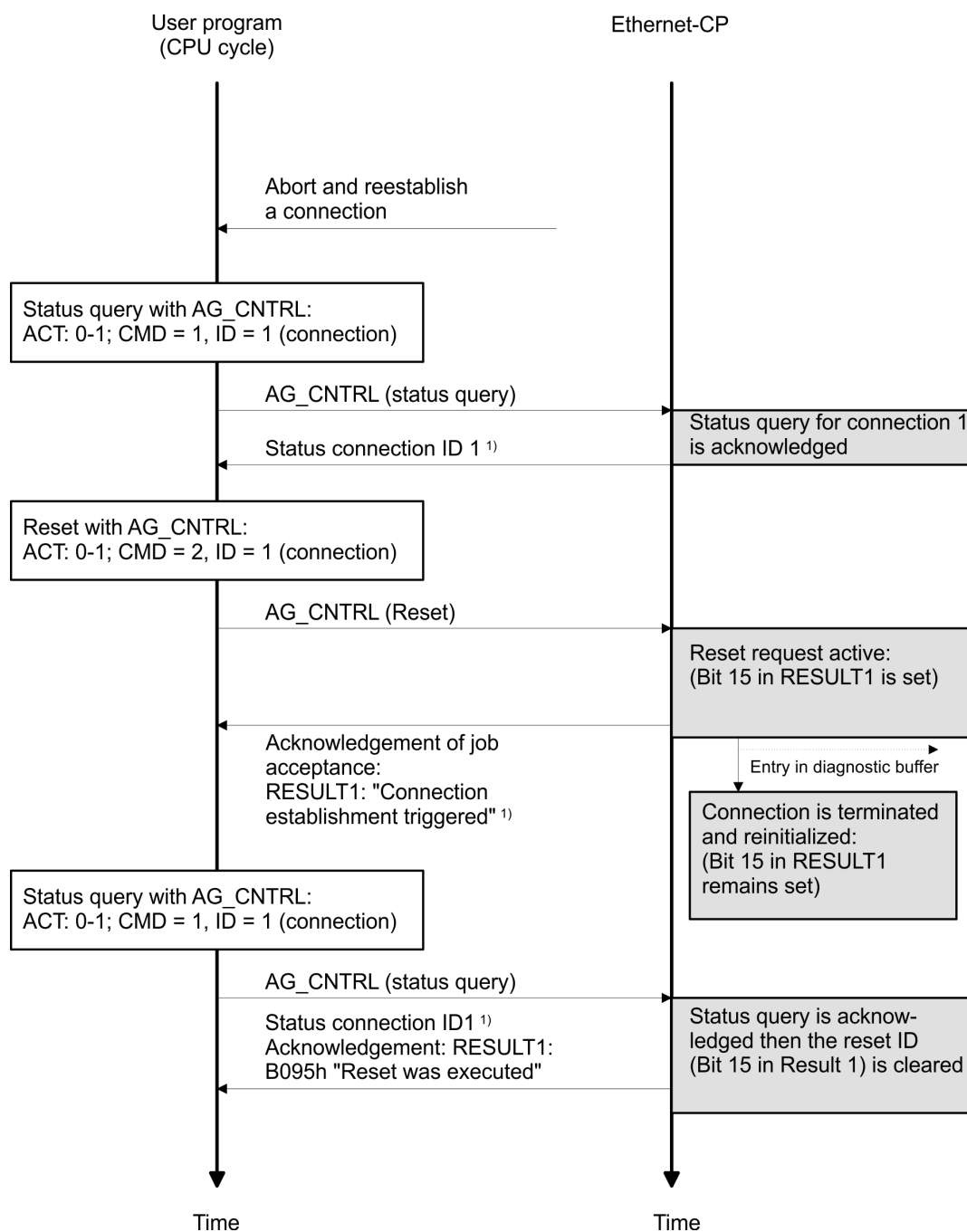

1) Parameter transfer *DONE*, *ERROR*, *STATUS* and *RESULT1/2*

Parameters

Parameter	Declaration	Data type	Description
ACT	INPUT	BOOL	Job triggered by edge change 0-1 of the memory bit <i>ACT</i>
ID	INPUT	INT	Connection ID according to configuration
LADDR	INPUT	WORD	Base address of CP in hardware configuration
CMD	INPUT	INT	Job ID
DONE	OUTPUT	BOOL	Execution code
ERROR	OUTPUT	BOOL	Error code

Parameter	Declaration	Data type	Description
STATUS	OUTPUT	WORD	Status code
RESULT1	OUTPUT	DWORD	Job result 1 under command
RESULT2	OUTPUT	DWORD	Job result 2 under command

ACT	<p>Possible values: 0, 1</p> <p>The FC is to be called with edge change 0-1 of <i>ACT</i>.</p> <p>If it is called with <i>ACT</i> = 0, there is no function call and the block is exited immediately.</p>
ID	<p>Possible values: 1, 2 ... n, or 0</p> <p>The number of the connection is specified in the parameter <i>ID</i>. The connection number may be found in the configuration. n is the maximum number of connections.</p> <p>If the call addresses every connection as <i>ID</i> 0 is to be specified (<i>_ALL</i>-function with <i>CMD</i> 3 respectively <i>CMD</i> 4).</p>
LADDR	<p>Module base address</p> <p>At CP configuration with the hardware configurator the module base address is displayed in the configuration table.</p> <p>Specify this address here.</p>
CMD	<p>Command to the FC AG_CNTRL</p>
DONE	<p>0: Job is still being processed or not yet triggered</p> <p>1: Job executed</p> <p>This parameter indicates whether or not the job was completed without errors.</p> <p>If <i>DONE</i> = 1 <i>RESULT</i> may be evaluated.</p>
ERROR	<p>0: No error</p> <p>1: Error indication</p>
STATUS	<p>Status indication</p>
RESULT1/2	<p>Information returned according to the command sent to the FC AG_CNTRL</p>
DONE, ERROR, STATUS	<p>The following table shows the messages that may be returned by the Ethernet-CP 343 after an AG_CNTRL call.</p> <p>Additional the command results in the parameters <i>RESULT1</i> and <i>RESULT2</i> are to be evaluated.</p>

DONE	ERROR	STATUS	Description
1	0	0000h	Job executed without error
0	0	0000h	No job executing
0	0	8181h	Job active, the block call is to be repeated with the same parameters until <i>DONE</i> or <i>ERROR</i> is returned.
0	1	8183h	There is no CP configuration for this job or the service has not yet started in the Ethernet-CP 343.
0	1	8186h	Parameter <i>ID</i> is invalid. The permitted <i>ID</i> depends on the selected command.
0	1	8187h	Parameter <i>CMD</i> is invalid
0	1	8188h	Sequence error in the <i>ACT</i> control
0	1	8090h	Module with this address does not exist or CPU in STOP.
0	1	8091h	The module base address is not on a double-word boundary.
0	1	80B0h	The module does not recognize the record set.
0	1	80C0h	The record set cannot be read.
0	1	80C1h	The specified record set is currently being processed.
0	1	80C2h	There are too many jobs pending.
0	1	80C3h	CPU resources (memory) occupied.
0	1	80C4h	Communication error (error occurs temporarily; it is usually best to repeat the job in the user program).
0	1	80D2h	The module base address is incorrect.

Status parameter at cold restart

The output parameters are set to the following values during a restart of the CP:

- *DONE* = 0
- *NDR* = 0
- *ERROR* = 8180h (at AG_RECV)
- *ERROR* = 8181h (at AG_SEND)



Please consider the block may only be called with new parameters if a job started before was just ended with *DONE* = 1.

Commands and evaluating the job results

The following table shows the possible commands and the results that may be evaluated in the parameters *RESULT1* and *RESULT2*.

CMD 0

NOP - no operation

The block is executed without a job being sent to the CP.

RESULT	Hex value/range	Description
RESULT 1	0000 0001h	Executed without error
RESULT 2	0000 0000h	Default

CMD 1

CN_STATUS - connection status

This command returns the status of the connection selected with the *ID* of the CP addressed by *LADDR*. If bit 15 (reset ID) is set, this is automatically reset (this action corresponds to the CMD 5 - CN_CLEAR_RESET).

RESULT	Hex value/range	Description
RESULT 1	0000 000xh	Bit 3 ... 0: Codes for the send direction (excluded: 0010 _b) Bit 0: Connection reserved for send and receive jobs Bit 1: Send job being executed Bit 3, 2: Previous job 00: No information 01: Send job completed successful 10: Send job not completed successfully
	0000 00x0h	Bit 7 ... 4: Codes for receive direction (excluded: 0010 _b) Bit 4: Connection reserved for send and receive jobs Bit 5: Receive job being executed Bit 7, 6: Previous job 00: No information 01: Receive job completed successfully 10: Receive job not completed successfully
	0000 0x00h	Bit 11 ... 8: Codes for FETCH/WRITE (excluded: 0011 _b , 0111 _b , 1000 _b , 1011 _b , 0010 _b) Bit 8: Connection type 0: No FETCH connection 1: Connection reserved for FETCH jobs Bit 9: Connection type 0: No WRITE connection 1: Connection reserved for WRITE jobs Bit 10: Job status (FETCH/ WRITE) 0: Job status OK 1: Job status not OK This ID is set in the following situations: - The job was acknowledged negatively by the CPU - The job could not be forwarded to the CPU because the connection was in the "LOCKED" status. - The job was rejected because the FETCH/WRITE header did not have the correct structure. Bit 11: Status of FETCH/WRITE job 0: No job active 1: Job from LAN active

RESULT	Hex value/range	Description
	0000 x000h	Bit 15 ... 12: General CP information (excluded: 0011 _b , 1011 _b) Bit 13, 12: Connection status (only available for SEND/RECV connections based on the ISO/RFC/TCP protocols; with UDP, the corresponding internal information is output) 00: Connection is terminated 01: Connection establishment active 10: Connection termination active 11: Connection is established Bit 14: CP information 0: CP in STOP 1: CP in RUN Bit 15: Reset ID 0: FC 10 has not yet reset a connection or the reset ID was cleared. 1: The FC 10 has executed a connection reset
	xxxx 0000h	Bit 31 ... 16: Reserved for later expansions
RESULT 2	0000 0000h	Reserved for later expansions

CMD 2

CN_RESET - connection reset

This command resets the connection selected with the *ID* of the CP addressed by *LADDR*.

Resetting the connection means that a connection is aborted and established again (active or passive depending on the configuration).

An entry is also generated in the diagnostic buffer in which the job result may be found.

RESULT	Hex value/range	Description
RESULT 1	0000 0001h	The reset job was transferred to the CP successfully. The connection abort and subsequent connection establishment were triggered.
	0000 0002h	The reset job could not be transferred to the CP because the service was not started on the CP (for example CP in STOP).
RESULT 2	0000 0000h	Default

CMD 3

CN_STATUS_ALL - all connections status

This command returns the connection status of all connections (established/terminated) in the *RESULT1/2* parameters (at total of 8byte of group information) of the CP addressed by *LADDR*.

The *ID* parameter must be set to "0" (checked for "0").

When necessary, you may obtain detailed information about a terminated or not configured connection using a further connection status call with *CMD* = 1.

RESULT	Hex value/range	Description
RESULT 1	xxxx xxxxh	32 Bit: Connection 1 ... 32 0: Connection terminated / not configured 1: Connection established
RESULT 2	xxxx xxxxh	32 Bit: Connection 33 ... 64 0: Connection terminated / not configured 1: Connection established

CMD 4

CN_RESET_ALL - all connections reset

This command resets all connection of the CP addressed by *LADDR*.

The *ID* parameter must be set to "0" (checked for "0").

Resetting the connection means that a connection is aborted and established again (active ore passive depending on the configuration).

An entry is also generated in the diagnostic buffer in which the job result may be found.

RESULT	Hex value/range	Description
RESULT 1	0000 0001h	The reset job was transferred to the CP successfully. The connection abort and subsequent connection establishment of every connection were triggered.
	0000 0002h	The reset job could not be transferred to the CP because the service was not started on the CP (for example CP in STOP).
RESULT 2	0000 0000h	Default

CMD 5

CN_CLEAR_RESET - Clear the reset ID

This command resets the reset ID (bit 15 in RESULT1) for the connection selected with the ID of the CP addressed by *LADDR*.

This job executes automatically when the connection status is read (*CMD* = 1); the separate job described here is therefore only required in special situations.

RESULT	Hex value/range	Description
RESULT 1	0000 0001h	The clear job was transferred to the CP successfully.
	0000 0002h	The clear job could not be transferred to the CP because the service was not started on the CP (for example CP in STOP).
RESULT 2	0000 0000h	Default

CMD 6

CN_DISCON - connection disconnect

This command resets the connection, which was selected by *ID* and *LADDR*. The reset is executed by means of aborting the connection.

Possibly in the stack stored data are lost without any instructions. After that no further connection is automatically established. The connection may again be established by the control job CN_STARTCON. An entry is also generated in the diagnostic buffer in which the job result may be found.

RESULT	Hex value/ range	Description
RESULT 1	0000 0001h	The job was transferred to the CP successfully. The connection abort was triggered.
	0000 0002h	This job could not be transferred to the CP because the service was not started on the CP (for example CP in STOP).
RESULT 2	0000 0000h	Default

CMD 7

CN_STARTCON - start connection

This command establishes a connection, which was selected by *ID* and *LADDR* and aborted by the control job CN_DISCON before. An entry is also generated in the diagnostic buffer in which the job result may be found.

RESULT	Hex value/ range	Description
RESULT 1	0000 0001h	The job was transferred to the CP successfully. The connection abort was triggered.
	0000 0002h	This job could not be transferred to the CP because the service was not started on the CP (for example CP in STOP).
RESULT 2	0000 0000h	Default

8.2.5 FC 62 - C_CNTR - Querying the Connection Status

Description

Query a connection status with FC 62. The current status of the communication that has been determined via *ID* is queried after the system function has been called with value 1 at the control input *EN_R*.

Parameters

Parameter	Declaration	Data Type	Memory Area	Description
EN_R	INPUT	BOOL	I, Q, M, D, constant	Control parameter enabled to receive, signals ready to receive if the input is set.
ID	INPUT	WORD	M, D, constant	Addressing parameter <i>ID</i> ,
RET_VAL	OUTPUT	INT	I, Q, M, D, L	Error information
ERROR	OUTPUT	BOOL	I, Q, M, D, L	Status parameter <i>ERROR</i> and <i>STATUS</i>

Parameter	Declaration	Data Type	Memory Area	Description
STATUS	OUTPUT	WORD	I, Q, M, D, L	<ul style="list-style-type: none"> ■ <i>ERROR</i> = 0 and <i>STATUS</i> have the values: <ul style="list-style-type: none"> – 0000h: Neither warning nor error – <> 0000h: Warning, <i>STATUS</i> supplies detailed information. ■ <i>ERROR</i> = 1 <ul style="list-style-type: none"> – There is an error. <i>STATUS</i> supplies detailed information on the type of error.
C_CONN	OUTPUT	BOOL	I, Q, M, D, L	Status of the corresponding connection. Possible values: <ul style="list-style-type: none"> ■ 0: The connection was dropped or it is not up. ■ 1: Connection is established.
C_STATUS	OUTPUT	WORD	I, Q, M, D, L	Connection status: <ul style="list-style-type: none"> ■ W#16#0000: Connection is not established ■ W#16#0001: Connection is being established ■ W#16#0002: Connection is established ■ W#16#000F: No data on connection status available (such as at CP startup) ■ W#16#00FF: Connection is not configured

Error Information

The output parameter *RET_VAL* can assume the following values at FC 62 C_CNTRL:

- 0000h: No error when FC was executed.
- 8000h: Error when FC was executed.



The output parameters ERROR and STATUS are to be evaluated regardless of the output parameter RET_VAL showing the value 0000h.

ERROR	STATUS (decimal)	Description
1	10	CP access error. Another job is currently running. Repeat job later.
1	27	There is no function code in the CPU for this block.

8.2.6 FB/SFB 8 - FB 55 - Overview

With the Siemens S7 connection large data sets may be transferred between via Ethernet connected PLC systems based on Siemens STEP7®. The communication connections are static i.e. they are to be configured in a connection table.

Possibilities of communication functions

- Siemens S7-300 communication functions
 - By including the VIPA specific function blocks FB 8 ... FB 55 you get access to the Siemens S7-300 communication functions. ↪ *Chap. 5 'Include VIPA library' page 69*
- Siemens S7-400 communication functions
 - To deploy the Siemens S7-400 communication functions the in the operating system of the CPU integrated system function blocks SFB 8 ... SFB 23 should be used. Here copy the interface description of the SFBs from the standard library at system function block to the directory container, generate an instance data block for each call and call the SFB with the associated instance data block.

Project engineering

Precondition for the Siemens S7 communication is a configured connection table, which contains the defined connections for communication. For this e.g. WinPLC7 from VIPA or NetPro from Siemens can be used. A communication connection is specified by a connection ID for each connection partner. Use the local ID to initialize the FB/SFB in the PLC from which the connection is regarded and the partner ID to configure the FB/SFB in the partner PLC.

Function blocks

FB/SFB	Designation	Description
FB/SFB 8	USEND	Uncoordinated data transmission
FB/SFB 9	URCV	Uncoordinated data reception
FB/SFB 12	BSEND	Sending data in blocks
FB/SFB 13	BRCV	Receiving data in blocks
FB/SFB 14	GET	Remote CPU read
FB/SFB 15	PUT	Remote CPU write
FB 55	IP_CONF	Programmed communication connections



Please use for the Siemens S7 communication exclusively the FB/SFBs listed here. The direct call of the associated internal SFCs leads to errors in the corresponding instance DB!

8.2.7 FB/SFB 8 - USEND - Uncoordinated data transmission

Description

FB/SFB 8 USEND may be used to transmit data to a remote partner FB/SFB of the type URCV (FB/SFB 9). You must ensure that parameter *R_ID* of both FB/SFBs is identical. The transmission is started by a positive edge at control input *REQ* and proceeds without coordination with the partner FB/SFB.

Depending upon communication function the following behavior is present:

- Siemens S7-300 Communication (FB 8)
 - The data is sent on a rising edge at *REQ*. The parameters *R_ID*, *ID* and *SD_1* are transferred on each rising edge at *REQ*. After a job has been completed, you can assign new values to the *R_ID*, *ID* and *SD_1* parameters.
- Siemens S7-400 Communication (SFB 8)
 - The data is sent on a rising edge at *REQ*. The data to be sent is referenced by the parameters *SD_1* ... *SD_4* but not all four send parameters need to be used.

Parameters

Parameter	Declaration	Data type	Memory block	Description
REQ	INPUT	BOOL	I, Q, M, D, L	Control parameter request, activates the exchange of data when a rising edge is applied (with respect to the most recent FB/SFB-call)
ID	INPUT	WORD	I, Q, M, D, constant	Connection reference. The <i>ID</i> must be specified in the form wxyzh.
R_ID	INPUT	DWORD	I, Q, M, D, constant	Addressing parameter <i>R_ID</i> . Format DW#16#wxyzWXYZ.
DONE	OUTPUT	BOOL	I, Q, M, D, L	Status parameter <i>DONE</i> : <ul style="list-style-type: none"> ■ 0: task has not been started or it is still being executed. ■ 1: task was executed without error.
ERROR	OUTPUT	BOOL	I, Q, M, D, L	Status parameter <i>ERROR</i> : <ul style="list-style-type: none"> ■ <i>ERROR</i> = 0 + <i>STATUS</i> = 0000h <ul style="list-style-type: none"> – No warnings or errors ■ <i>ERROR</i> = 0 + <i>STATUS</i> unequal to 0000h <ul style="list-style-type: none"> – A Warning has occurred. <i>STATUS</i> contains detailed information. ■ <i>ERROR</i> = 1 <ul style="list-style-type: none"> – An error has occurred.
STATUS	OUTPUT	WORD	I, Q, M, D, L	Status parameter <i>STATUS</i> , returns detailed information about the type of error.
SD_i, 1 ≤ i ≤ 4	IN_OUT	ANY	I, Q, M, D, T, C	Pointer to transmit buffer i.. Only data type BOOL is valid (Bit field not permitted), BYTE, CHAR, WORD, INT, DWORD, DINT, REAL, DATE, TOD, TIME, S5TIME, DATE_AND_TIME, COUNTER, TIMER.



You must, however, make sure that the areas defined by the parameters *SD_1/SD_1...SD_4* and *RD_1/RD_1...RD_4* (at the corresponding partner FB/SFB URCV) agree in Number, Length and Data type.

The parameter *R_ID* must be identical at both FB/SFBs. Successful completion of the transmission is indicated by the status parameter *DONE* having the logical value 1.

Error information

ERROR	STATUS (decimal)	Description
0	11	Warning: the new task is not active, since the previous task has not completed.
0	25	Communications initiated. The task is being processed.
1	1	Communication failures, e.g. <ul style="list-style-type: none"> ■ Connection parameters not loaded (local or remote) ■ Connection interrupted (e.g. cable, CPU turned off, CP in STOP)
1	4	Error in transmission range pointers <i>SD_i</i> with respect to the length or the data type.
1	10	Access to local application memory not possible (e.g. access to deleted DB).
1	12	The call to the FB/SFB <ul style="list-style-type: none"> ■ contains an instance DB that does not belong to the FB/SFB 8 ■ contains a global DB instead of an instance DB ■ could not locate an instance DB (load a new instance DB from the PG)
1	18	<i>R_ID</i> already exists in the connection <i>ID</i> .
1	20	Not enough memory.

Data consistency

To ensure the data consistency is not compromised, can the currently used transmission ranges *SD_i* be described again only if the current job is completed. This requires that the *DONE* parameter is evaluated. This is the case when the value of the status parameter *DONE* changes to 1.

8.2.8 FB/SFB 9 - URCV - Uncoordinated data reception

Description

FB/SFB 9 URCV can be used to receive data asynchronously from a remote partner FB/SFB of the type USEND (FB/SFB 8). You must ensure that parameter *R_ID* of both FB/SFBs is identical. The block is ready to receive then there is a logical 1 at the *EN_R* input. An active job can be cancelled with *EN_R=0*.

Depending upon communication function the following behavior is present:

- Siemens S7-300 Communication (FB 9)
 - The parameters *R_ID*, *ID* and *RD_1* are applied with every positive edge on *EN_R*. After a job has been completed, you can assign new values to the *R_ID*, *ID* and *RD_1* parameters.
- Siemens S7-400 Communication (SFB 9)
 - The receive data areas are referenced by the parameters *RD_1...RD_4*.

Parameters

Parameter	Declaration	Data type	Memory block	Description
EN_R	INPUT	BOOL	I, Q, M, D, L	Control parameter enabled to receive, indicates that the partner is ready for reception
ID	INPUT	WORD	I, Q, M, D, constant	A reference for the connection. Format wxyz
R_ID	INPUT	DWORD	I, Q, M, D, constant	Address parameter <i>R_ID</i> . Format DW#16#wxyzWXYZ.
NDR	OUTPUT	BOOL	I, Q, M, D, L	Status parameter <i>NDR</i> : new data transferred.
ERROR	OUTPUT	BOOL	I, Q, M, D, L	Status parameter <i>ERROR</i> : <ul style="list-style-type: none"> ■ <i>ERROR</i> = 0 + <i>STATUS</i> = 0000h <ul style="list-style-type: none"> – No warnings or errors ■ <i>ERROR</i> = 0 + <i>STATUS</i> unequal to 0000h <ul style="list-style-type: none"> – A Warning has occurred. <i>STATUS</i> contains detailed information. ■ <i>ERROR</i> = 1 <ul style="list-style-type: none"> – An error has occurred.
STATUS	OUTPUT	WORD	I, Q, M, D, L	Status parameter <i>STATUS</i> , returns detailed information about the type of error.
RD_i, 1 ≤ i ≤ 4	IN_OUT	ANY	I, Q, M, D, T, C	Pointer to receive buffer i. Only data type BOOL is valid (Bit field not permitted), BYTE, CHAR, WORD, INT, DWORD, DINT, REAL, DATE, TOD, TIME, S5TIME, DATE_AND_TIME, COUNTER, TIMER.



The quantity, length and data type of the buffer areas defined by parameters *SD_i* and *RD_i*, $1 \leq i \leq 4$ must be identical (*RD_i* is the receive buffer of the respective partner FB/SFB, see FB/SFB 8). The initial call to FB/SFB 9 creates the "receive box". The receive data available during any subsequent calls must fit into this receive box. When a data transfer completes successfully parameter *NDR* is set to 1.

Error information

ERROR	STATUS (decimal)	Description
0	9	Overrun warning: old receive data was overwritten by new receive data.
0	11	Warning: the new task is not active since the previous task has not completed.
0	25	Communications initiated. The task is being processed.

ERROR	STATUS (decimal)	Description
1	1	Communication failures, e.g. <ul style="list-style-type: none"> ■ Connection parameters not loaded (local or remote) ■ Connection interrupted (e.g. cable, CPU turned off, CP in STOP)
1	4	Error in receive buffer pointer <i>RD_i</i> with respect to the length or the data type.
1	10	Access to local application memory not possible (e.g. access to deleted DB).
1	12	The call to the FB/SFB <ul style="list-style-type: none"> ■ contains an instance DB that does not belong to the FB/SFB 9 ■ contains a global DB instead of an instance DB ■ could not locate an instance DB (load a new instance DB from the PG)
1	18	<i>R_ID</i> already exists in the connection ID.
1	19	The respective FB/SFB USEND transmits data quicker than FB/SFB URCV can copy the data into the receive buffers.
1	20	Not enough memory.

Data consistency

The data are received consistently if you remember the following points:

- Siemens S7-300 Communication:
 - After the status parameter *NDR* has changed to the value 1, you must immediately call FB 9 URCV again with the value 0 at *EN_R*. This ensures that the receive area is not overwritten before you have evaluated it. Evaluate the receive area (*RD_1*) completely before you call the block with the value 1 at control input *EN_R*.
- Siemens S7-400 Communication:
 - After the status parameter *NDR* has changed to the value 1, there are new receive data in your receive areas (*RD_i*). A new block call may cause these data to be overwritten with new receive data. If you want to prevent this, you must call SFB 9 URCV (such as with cyclic block processing) with the value 0 at *EN_R* until you have finished processing the receive data.

8.2.9 FB/SFB 12 - BSEND - Sending data in blocks

Description

FB/SFB 12 BSEND sends data to a remote partner FB/SFB of the type BRCV (FB/SFB 13). The data area to be transmitted is segmented. Each segment is sent individually to the partner. The last segment is acknowledged by the partner as it is received, independently of the calling up of the corresponding FB/SFB/BRCV. With this type of data transfer, more data can be transported between the communications partners than is possible with all other communication FBs/SFBs for configured S7 connections, namely 65534 bytes.



Please note that this block calls the FC or SFC 202 AG_BSEND internally. These must not be overwritten! The direct call of an internal block leads to errors in the corresponding instance DB!

Depending upon communication function the following behavior is present:

- **Siemens S7-300 Communication (FB 12)**
 - The send job is activated on a rising edge at *REQ*. The parameters *R_ID*, *ID*, *SD_1* and *LEN* are transferred on each positive edge at *REQ*. After a job has been completed, you can assign new values to the *R_ID*, *ID*, *SD_1* and *LEN* parameters. For the transmission of segmented data the block must be called periodically in the user program. The start address and the maximum length of the data to be sent are specified by *SD_1*. You can determine the job-specific length of the data field with *LEN*.
- **Siemens S7-400 Communication (SFB 12)**
 - The send job is activated after calling the block and when there is a rising edge at *REQ*. Sending the data from the user memory is carried out asynchronously to the processing of the user program. The start address and the maximum length of the data to be sent are specified by *SD_1*. You can determine the job-specific length of the data field with *LEN*. In this case, *LEN* replaces the length section of *SD_1*.

Function

- If there is a rising edge at control input *R*, the current data transfer is cancelled.
- Successful completion of the transfer is indicated by the status parameter *DONE* having the value 1.
- A new send job cannot be processed until the previous send process has been completed if the status parameter *DONE* or *ERROR* have the value 1.
- Due to the asynchronous data transmission, a new transmission can only be initiated if the previous data have been retrieved by the call of the partner FB/SFB. Until the data are retrieved, the status value 7 will be given when the FB/SFB BSEND is called.



*The parameter *R_ID* must be identical at the two corresponding FBs/SFBs.*

Parameters

Parameter	Declaration	Data type	Memory block	Description
REQ	INPUT	BOOL	I, Q, M, D, L	Control parameter request, a rising edge activates the data exchange (with respect to the most recent FB/SFB call)
R	INPUT	BOOL	I, Q, M, D, L, constant	control parameter reset: terminates the active task

Parameter	Declaration	Data type	Memory block	Description
ID	INPUT	WORD	I, Q, M, D, constant	A reference for the connection. Format W#16#xxxx
R_ID	INPUT	DWORD	I, Q, M, D, L, constant	Address parameter <i>R_ID</i> . Format DW#16#wxyzWXYZ.
DONE	OUTPUT	BOOL	I, Q, M, D, L	Status parameter <i>DONE</i> : 0: task has not been started or is still being executed. 1: task was executed without error.
ERROR	OUTPUT	BOOL	I, Q, M, D, L	Status parameter <i>ERROR</i> : <ul style="list-style-type: none"> ■ <i>ERROR</i> = 0 + <i>STATUS</i> = 0000h <ul style="list-style-type: none"> – No warnings or errors. ■ <i>ERROR</i> = 0 + <i>STATUS</i> unequal to 0000h <ul style="list-style-type: none"> – A Warning has occurred. <i>STATUS</i> contains detailed information. ■ <i>ERROR</i> = 1 <ul style="list-style-type: none"> – An error has occurred.
STATUS	OUTPUT	WORD	I, Q, M, D, L	Status parameter <i>STATUS</i> , returns detailed information about the type of error.
SD_1	IN_OUT	ANY	I, Q, M, D, T, C	Pointer to the send data buffer. The length parameter is only utilized when the block is called for the first time after a start. It specifies the maximum length of the send buffer. Only data type BOOL is valid (Bit field not permitted), BYTE, CHAR, WORD, INT, DWORD, DINT, REAL, DATE, TOD, TIME, S5TIME, DATE_AND_TIME, COUNTER, TIMER.
LEN	IN_OUT	WORD	I, Q, M, D, L	The length of the send data block in bytes.

Error information

ERROR	STATUS (decimal)	Description
0	11	Warning: the new task is not active since the previous task has not completed.
0	25	The communication process was initiated. The task is being processed.
1	1	Communication failures, e.g.: <ul style="list-style-type: none"> ■ Connection parameters not loaded (local or remote) ■ Connection interrupted (e.g. cable, CPU turned off, CP in STOP)
1	2	Negative acknowledgment received from the partner FB/SFB. The function cannot be executed.
1	3	<i>R_ID</i> is not available to the communication link specified by ID or the receive block has never been called.
1	4	Error in send buffer pointer <i>SD_1</i> with respect to the length or the data type, or parameter <i>LEN</i> was set to 0 or an error has occurred in the receive data buffer pointer <i>RD_1</i> of the respective FB/SFB 13 BRCV

ERROR	STATUS (decimal)	Description
1	5	Reset request was executed.
1	6	The status of the partner FB/SFB is DISABLED (<i>EN_R</i> has a value of 0)
1	7	The status of the partner FB/SFB is not correct (the receive block has not been called after the most recent data transfer).
1	8	Access to the remote object in application memory was rejected.
1	10	Access to local application memory not possible (e.g. access to deleted DB).
1	12	The call to the FB/SFB <ul style="list-style-type: none"> ■ contains an instance DB that does not belong to the FB/SFB 12 ■ contains a global DB instead of an instance DB ■ could not locate an instance DB (load a new instance DB from the PG)
1	18	<i>R_ID</i> already exists in the connection ID.
1	20	Not enough memory.

Data consistency

To guarantee consistent data the segment of send buffer *SD_1* that is currently being used can only be overwritten when current send process has been completed. For this purpose the program can test parameter *DONE*.

8.2.10 FB/SFB 13 - BRCV - Receiving data in blocks

Description

The FB/SFB 13 BRCV can receive data from a remote partner FB/SFB of the type BSEND (FB/SFB 12). The parameter *R_ID* of both FB/SFBs must be identical. After each received data segment an acknowledgment is sent to the partner FB/SFB and the *LEN* parameter is updated.



Please note that this block calls the FC or SFC 203 AG_BRCV internally. These must not be overwritten! The direct call of an internal block leads to errors in the corresponding instance DB!

Depending upon communication function the following behavior is present:

- **Siemens S7-300 Communication (FB 13)**
 - The parameters *R_ID*, *ID* and *RD_1* are applied with every positive edge on *EN_R*. After a job has been completed, you can assign new values to the *R_ID*, *ID* and *RD_1* parameters. For the transmission of segmented data the block must be called periodically in the user program.
- **Siemens S7-400 Communication (SFB 13)**
 - Receipt of the data from the user memory is carried out asynchronously to the processing of the user program.

Parameters

Parameter	Declaration	Data type	Memory block	Description
EN_R	INPUT	BOOL	I, Q, M, D, L, constant	control parameter enabled to receive, indicates that the partner is ready for reception
ID	INPUT	WORD	I, Q, M, D, constant	A reference for the connection. Format: W#16#xxxx
R_ID	INPUT	DWORD	I, Q, M, D, L, constant	Address parameter <i>R_ID</i> . Format: DW#16#wxyzWXYZ
NDR	OUTPUT	BOOL	I, Q, M, D, L	Status parameter NDR: new data accepted.
ERROR	OUTPUT	BOOL	I, Q, M, D, L	Status parameter <i>ERROR</i> : <ul style="list-style-type: none"> ■ <i>ERROR</i> = 0 + <i>STATUS</i> = 0000h <ul style="list-style-type: none"> – No warnings or errors. ■ <i>ERROR</i> = 0 + <i>STATUS</i> unequal to 0000h <ul style="list-style-type: none"> – A Warning has occurred. <i>STATUS</i> contains detailed information. ■ <i>ERROR</i> = 1 <ul style="list-style-type: none"> – An error has occurred.
STATUS	OUTPUT	WORD	I, Q, M, D, T, C	Status parameter <i>STATUS</i> , returns detailed information about the type of error.
RD_1	IN_OUT	ANY	I, Q, M, D, T, C	Pointer to the receive data buffer. The length specifies the maximum length for the block that must be received. Only data type BOOL is valid (Bit field not permitted), BYTE, CHAR, WORD, INT, DWORD, DINT, REAL, DATE, TOD, TIME, S5TIME, DATE_AND_TIME, COUNTER, TIMER.
LEN	IN_OUT	WORD	I, Q, M, D, L	Length of the data that has already been received.

Function

- The FB/SFB 13 is ready for reception when control input *EN_R* is set to 1. Parameter *RD_1* specifies the start address of the receive data buffer. An acknowledgment is returned to the partner FB/SFB after reception of each data segment and parameter *LEN* of the FB/SFB 13 is updated accordingly. If the block is called during the asynchronous reception process a warning is issued via the status parameter *STATUS*.
- Should this call be received with control input *EN_R* set to 0 then the receive process is terminated and the FB/SFB is reset to its initial state. When all data segments have been received without error parameter *NDR* is set to 1. The received data remains unaltered until FB/SFB 13 is called again with parameter *EN_R* = 1.

Error information

ERROR	STATUS (decimal)	Description
0	11	Warning: the new task is not active since the previous task has not completed.
0	17	Warning: block is receiving asynchronous data.
0	25	Communications has been initiated. The task is being processed.
1	1	Communication failures, e.g. <ul style="list-style-type: none"> ■ Connection parameters not loaded (local or remote) ■ Connection interrupted (e.g. cable, CPU turned off, CP in STOP)
1	2	Function cannot be executed.
1	4	Error in the receive data block pointer <i>RD_1</i> with respect to the length or the data type (the send data block is larger than the receive data block).
1	5	Reset request received, incomplete data transfer.
1	8	Access to the remote object in application memory was rejected.
1	10	Access to local application memory not possible (e.g. access to deleted DB).
1	12	The call to the FB/SFB <ul style="list-style-type: none"> ■ contains an instance DB that does not belong to the FB/SFB 13 ■ contains a global DB instead of an instance DB ■ could not locate an instance DB (load a new instance DB from the PG)
1	18	<i>R_ID</i> already exists in the connection <i>ID</i> .
1	20	Not enough memory.

Data consistency

To guarantee data consistency during reception the following points must be met:

- When copying has been completed (parameter *NDR* is set to 1) FB/SFB 13 must again be called with parameter *EN_R* set to 0 in order to ensure that the receive data block is not overwritten before it has been evaluated.
- The most recently used receive data block *RD_1* must have been evaluated completely before the block is denoted as being ready to receive (calls with parameter *EN_R* set to 1).

Receiving Data S7-400

- If a receiving CPU with a BRCV block ready to accept data (that is, a call with $EN_R = 1$ has already been made) goes into STOP mode before the corresponding send block has sent the first data segment for the job, the following will occur:
- The data in the first job after the receiving CPU has gone into STOP mode are fully entered in the receive area.
- The partner SFB BSEND receives a positive acknowledgment.
- Any additional BSEND jobs can no longer be accepted by a receiving CPU in STOP mode.
- As long as the CPU remains in STOP mode, both NDR and LEN have the value 0.
- To prevent information about the received data from being lost, you must perform a hot restart of the receiving CPU and call SFB 13 BRCV with $EN_R = 1$.

8.2.11 FB/SFB 14 - GET - Remote CPU read

Description

The FB/SFB 14 GET can be used to read data from a remote CPU. The respective CPU must be in RUN mode or in STOP mode.



Please note that this block calls the FC or SFC 200 AG_GET internally. These must not be overwritten! The direct call of an internal block leads to errors in the corresponding instance DB!

Depending upon communication function the following behavior is present:

- **Siemens S7-300 Communication (FB 14)**
 - The data is read on a rising edge at REQ . The parameters ID , $ADDR_1$ and RD_1 are transferred on each rising edge at REQ . After a job has been completed, you can assign new values to the ID , $ADDR_1$ and RD_1 parameters.
- **Siemens S7-400 Communication (SFB 14)**
 - The SFB is started with a rising edge at REQ . In the process the relevant pointers to the areas to be read out ($ADDR_i$) are sent to the partner CPU.

Parameters

Parameter	Declaration	Data type	Memory block	Description
REQ	INPUT	BOOL	I, Q, M, D, L	control parameter request, a rising edge activates the data exchange (with respect to the most recent FB/SFB-call)
ID	INPUT	WORD	I, Q, M, D, constant	A reference for the connection. Format: W#16#xxxx
NDR	OUTPUT	BOOL	I, Q, M, D, L	Status parameter NDR : data from partner CPU has been accepted.
ERROR	OUTPUT	BOOL	I, Q, M, D, L	Status parameter $ERROR$: <ul style="list-style-type: none"> ■ $ERROR = 0 + STATUS = 0000h$ <ul style="list-style-type: none"> – No warnings or errors. ■ $ERROR = 0 + STATUS$ unequal to 0000h <ul style="list-style-type: none"> – A Warning has occurred. $STATUS$ contains detailed information. ■ $ERROR = 1$ <ul style="list-style-type: none"> – An error has occurred.

Parameter	Declaration	Data type	Memory block	Description
STATUS	OUTPUT	WORD	I, Q, M, D, L	Status parameter <i>STATUS</i> , returns detailed information about the type of error.
ADDR_1	IN_OUT	ANY	e.g. I, Q, M, D	Pointer indicating the buffers in the partner CPU that must be read
ADDR_2	IN_OUT	ANY	e.g. I, Q, M, D	Pointer indicating the buffers in the partner CPU that must be read
ADDR_3	IN_OUT	ANY	e.g. I, Q, M, D	Pointer indicating the buffers in the partner CPU that must be read
ADDR_4	IN_OUT	ANY	e.g. I, Q, M, D	Pointer indicating the buffers in the partner CPU that must be read
RD_i, 1 ≤ i ≤ 4	IN_OUT	ANY	I, Q, M, D, T, C	Pointers to the area of the local CPU in which the read data are entered. Only data type BOOL is valid (bit field not permitted), BYTE, CHAR, WORD, INT, DWORD, DINT, REAL, DATE, TOD, TIME, S5TIME, DATE_AND_TIME, COUNTER, TIMER.

Function

- The remote CPU returns the data and the answer is checked for access problems during the read process for the data. The data type is checked in addition.
- When a data transfer error is detected the received data are copied into the configured receive data buffer (*RD_i*) with the next call to FB/SFB 14 and parameter *NDR* is set to 1.
- It is only possible to activate a new read process when the previous read process has been completed. You must ensure that the defined parameters on the *ADDR_i* and *RD_i* areas and the number that fit in quantity, length and data type of data to each other.

Error information

ERROR	STATUS (decimal)	Description
0	11	Warning: the new task is not active since the previous task has not completed.
0	25	The communication process was initiated. The task is being processed.
1	1	Communication failures, e.g. <ul style="list-style-type: none"> ■ Connection parameters not loaded (local or remote) ■ Connection interrupted (e.g.: cable, CPU turned off, CP in STOP)
1	2	Negative acknowledgment from partner device. The function cannot be executed.
1	4	Error in receive data buffer pointer <i>RD_i</i> with respect to the length or the data type.
1	8	Partner CPU access error
1	10	Access to local application memory not possible (e.g. access to deleted DB).

ERROR	STATUS (decimal)	Description
1	12	The call to the FB/SFB <ul style="list-style-type: none"> ■ contains an instance DB that does not belong to the FB/SFB 14 ■ contains a global DB instead of an instance DB ■ could not locate an instance DB (load a new instance DB from the PG)
1	20	Not enough memory.

Data consistency

The data are received consistently if you evaluate the current use of range RD_i completely before initiating another job.

8.2.12 FB/SFB 15 - PUT - Remote CPU write**Description**

The FB/SFB 15 PUT can be used to write data to a remote CPU. The respective CPU may be in RUN mode or in STOP mode.



Please note that this block calls the FC or SFC 201 AG_PUT internally. These must not be overwritten! The direct call of an internal block leads to errors in the corresponding instance DB!

Depending upon communication function the following behavior is present:

- **Siemens S7-300 Communication (FB 15)**
 - The data is sent on a rising edge at REQ . The parameters ID , $ADDR_1$ and SD_1 are transferred on each rising edge at REQ . After a job has been completed, you can assign new values to the ID , $ADDR_1$ and SD_1 parameters.
- **Siemens S7-400 Communication (SFB 15)**
 - The SFB is started on a rising edge at REQ . In the process the pointers to the areas to be written ($ADDR_i$) and the data (SD_i) are sent to the partner CPU.

Parameters

Parameter	Declaration	Data type	Memory block	Description
REQ	INPUT	BOOL	I, Q, M, D, L	control parameter request, a rising edge activates the data exchange (with respect to the most recent FB/SFB-call)
ID	INPUT	WORD	I, Q, M, D, constant	A reference for the connection. Format $W\#16\#xxxx$
DONE	OUTPUT	BOOL	I, Q, M, D, L	Status parameter $DONE$: function completed.

Parameter	Declaration	Data type	Memory block	Description
ERROR	OUTPUT	BOOL	I, Q, M, D, L	Status parameter <i>ERROR</i> : <ul style="list-style-type: none"> ■ <i>ERROR</i> = 0 + <i>STATUS</i> = 0000h <ul style="list-style-type: none"> – No warnings or errors. ■ <i>ERROR</i> = 0 + <i>STATUS</i> unequal to 0000h <ul style="list-style-type: none"> – A Warning has occurred. <i>STATUS</i> contains detailed information. ■ <i>ERROR</i> = 1 <ul style="list-style-type: none"> – An error has occurred.
STATUS	OUTPUT	WORD	I, Q, M, D, L	Status parameter <i>STATUS</i> , returns detailed information about the type of error.
ADDR_1	IN_OUT	ANY	e.g. I, Q, M, D	Pointer indicating the buffers in the partner CPU into which data is written
ADDR_2	IN_OUT	ANY	e.g. I, Q, M, D	Pointer indicating the buffers in the partner CPU into which data is written
ADDR_3	IN_OUT	ANY	e.g. I, Q, M, D	Pointer indicating the buffers in the partner CPU into which data is written
ADDR_4	IN_OUT	ANY	e.g. I, Q, M, D	Pointer indicating the buffers in the partner CPU into which data is written
SD_i, 1 ≤ i ≤ 4	IN_OUT	ANY	I, Q, M, D, T, C	Pointer to the data buffers in the local CPU that contains the data that must be sent. Only data type BOOL is valid (Bit field not permitted), BYTE, CHAR, WORD, INT, DWORD, DINT, REAL, DATE, TOD, TIME, S5TIME, DATE_AND_TIME, COUNTER, TIMER.

Function

- The partner CPU stores the data at the respective address and returns an acknowledgment.
- This acknowledgment is tested and when an error is detected in the data transfer parameter *DONE* is set to 1 with the next call of FB/SFB 15.
- The write process can only be activated again when the most recent write process has been completed. The amount, length and data type of the buffer areas that were defined by means of parameters *ADDR_i* and *SD_i*, $1 \leq i \leq 4$ must be identical.

Error information

ERROR	STATUS (decimal)	Description
0	11	Warning: the new task is not active since the previous task has not completed.
0	25	The communication process was initiated. The task is being processed.
1	1	Communication failures, e.g. <ul style="list-style-type: none"> ■ Connection parameters not loaded (local or remote) ■ Connection interrupted (e.g.: cable, CPU turned off, CP in STOP)
1	2	Negative acknowledgment from partner device. The function cannot be executed.

ERROR	STATUS (decimal)	Description
1	4	Error in transmission range pointers <i>SD_i</i> with respect to the length or the data type
1	8	Partner CPU access error
1	10	Access to local application memory not possible (e.g. access to deleted DB).
1	12	The call to the FB/SFB contains an instance DB that does not belong to the FB/SFB 15. contains a global DB instead of an instance DB. could not locate an instance DB (load a new instance DB from the PG).
1	20	Not enough memory.

Data consistency

- *Siemens S7-300 Communication*
 - In order to ensure data consistency, send area *SD_1* may not be used again for writing until the current send process has been completed. This is the case when the state parameter *DONE* has the value "1".
- *Siemens S7-400 Communication*
 - When a send operation is activated (rising edge at *REQ*) the data to be sent from the send area *SD_i* are copied from the user program. After the block call, you can write to these areas without corrupting the current send data.

8.2.13 FB 55 - IP_CONF - Progr. Communication Connections**8.2.13.1 Overview**

To configure flexible communication connections, the FB 55 - IP_CONF allows the program controlled transfer of data blocks with configuration data for a CP.



Please note that this block calls the FC or SFC 204 IP_CONF internally. These must not be overwritten! The direct call of an internal block leads to errors in the corresponding instance DB!

Principle

Configuration data for communication connections may be transferred to the CPU by the FB 55 called in the user program. The configuration DB may be loaded into the CP at any time.

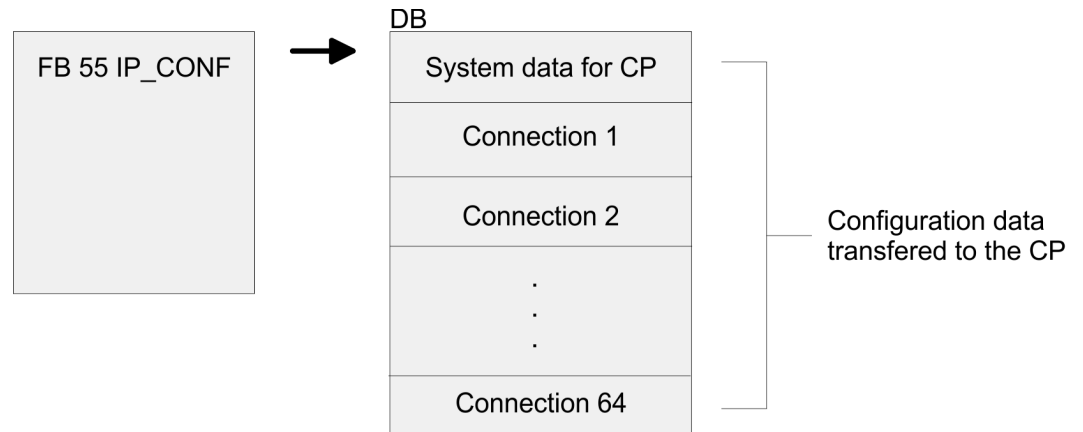

CAUTION!

As soon as the user program transfers the connection data via FB 55 IP_CONF, the CPU switches the CP briefly to STOP. The CP accepts the system data (including IP address) and the new connection data and processes it during startup (RUN).

8.2.13.2 FB 55 - IP_CONF

Depending on the size of the configuration DB, the data may be transferred to the CP in several segments. This means that the FB must as long be called as the FB signals complete transfer by setting the *DONE* bit to 1.

The Job is started with *ACT* = 1.

Parameters

Parameter	Declaration	Data type	Memory block	Description
ACT	INPUT	BOOL	I, Q, M, D, L	<ul style="list-style-type: none"> When the FB is called with <i>ACT</i> = 1, the DBxx is transmitted to the CP. If the FB is called with <i>ACT</i> = 0, only the status codes <i>DONE</i>, <i>ERROR</i> and <i>STATUS</i> are updated.
LADDR	INPUT	WORD	I, Q, M, D, constant	Module base address When the CP is configured by the hardware configuration, the module base address is displayed in the configuration table. Enter this address here.
CONF_DB	INPUT	ANY	I, Q, M, D	The parameter points to the start address of the configuration data area in a DB.
LEN	INPUT	INT	I, Q, M, D, constant	Length information in bytes for the configuration data area.
DONE	OUTPUT	BOOL	I, Q, M, D, L	The parameter indicates whether the configuration data areas was completely transferred. Remember that it may be necessary to call the FB several times depending on the size of the configuration data area (in several cycles) until the <i>DONE</i> parameter is set to 1 to signal completion of the transfer.
ERROR	OUTPUT	BOOL	I, Q, M, D, L	Error code

Parameter	Declaration	Data type	Memory block	Description
STATUS	OUTPUT	WORD	I, Q, M, D	Status code
EXT_STATUS	OUTPUT	WORD	I, Q, M, D	<p>If an error occurs during the execution of a job, the parameter indicates, which parameter was detected as the cause of the error in the configuration DB.</p> <ul style="list-style-type: none"> ■ High byte: Index of the parameter block ■ Low byte: Index of the subfield within the parameter block

Error information

ERROR	STATUS	Description
0	0000h	Job completed without errors
0	8181h	Job active
1	80B1h	The amount of data to be sent exceeds the upper limit permitted for this service.
1	80C4h	<p>Communication error</p> <p>The error can occur temporarily; it is usually best to repeat the job in the user program.</p>
1	80D2h	Configuration error, the module you are using does not support this service.
1	8183h	The CP rejects the requested record set number.
1	8184h	System error or illegal parameter type.
1	8185h	The value of the <i>LEN</i> parameter is larger than the <i>CONF_DB</i> less the reserved header (4bytes) or the length information is incorrect.
1	8186h	Illegal parameter detected. The ANY pointer <i>CONF_DB</i> does not point to data block.
1	8187h	Illegal status of the FB. Data in the header of <i>CONF_DB</i> was possibly overwritten.
1	8A01h	The status code in the record set is invalid (value is ≥ 3).
1	8A02h	There is no job running on the CP; however the FB has expected an acknowledgment for a completed job.
1	8A03h	There is no job running on the CP and the CP is not ready; the FB triggered the first job to read a record set.
1	8A04h	There is no job running on the CP and the CP is not ready; the FB nevertheless expected an acknowledgment for a completed job.
1	8A05h	There is a job running, but there was no acknowledgment; the FB nevertheless triggered the first job for a read record set job.
1	8A06h	A job is complete but the FB nevertheless triggered the first job for a read record sets job.
1	8B01h	Communication error, the DB could not be transferred.
1	8B02h	Parameter error, double parameter field
1	8B03h	Parameter error, the subfield in the parameter field is not permitted.
1	8B04h	Parameter error, the length specified in the FB does not match the length of the parameter fields/subfields.
1	8B05h	Parameter error, double parameter field.
1	8B06h	Parameter error, the subfield in the parameter field is not permitted.

ERROR	STATUS	Description
1	8B07h	Parameter error, the length of the parameter field is invalid.
1	8B08h	Parameter error, the ID of the subfield is invalid.
1	8B09h	System error, the connection does not exist.
1	8B0Ah	Data error, the content of the subfield is not correct.
1	8B0Bh	Structure error, a subfield exists twice.
1	8B0Ch	Data error, the parameter does not contain all the necessary parameters.
1	8B0Dh	Data error, the <i>CONF_DB</i> does not contain a parameter field for system data.
1	8B0Eh	Data error/structure error, the <i>CONF_DB</i> type is invalid.
1	8B0Fh	System error, the CP does not have enough resources to process <i>CONF_DB</i> completely.
1	8B10	Data error, configuration by the user program is not set.
1	8B11	Data error, the specified type of parameter field is invalid.
1	8B12	Data error, too many connections were specified.
1	8B13	CP internal error
1	8F22h	Area length error reading a parameter.
1	8F23h	Area length error writing a parameter.
1	8F24h	Area error reading a parameter.
1	8F25h	Area error writing a parameter.
1	8F28h	Alignment error reading a parameter.
1	8F29h	Alignment error writing a parameter.
1	8F30h	The parameter is in the write-protected first current data block.
1	8F31h	The parameter is in the write-protected second current data block.
1	8F32h	The parameter contains a DB number that is too high.
1	8F33h	DB number error
1	8F3Ah	The target area was not loaded (DB).
1	8F42h	Timeout reading a parameter from the I/O area.
1	8F43h	Timeout writing a parameter from the I/O area.
1	8F44h	Address of the parameter to be read is disabled in the accessed rack.
1	8F45h	Address of the parameter to be written is disabled in the accessed rack.
1	8F7Fh	Internal error

8.2.13.3 Configuration Data Block

The configuration data block (*CONF_DB*) contains all the connection data and configuration data (IP address, subnet mask, default router, NTP time server and other parameters) for an Ethernet CP. The configuration data block is transferred to the CP with function block FB 55.

Structure

The *CONF_DB* can start at any point within a data block as specified by an offset range. The connections and specific system data are described by an identically structured parameter field.

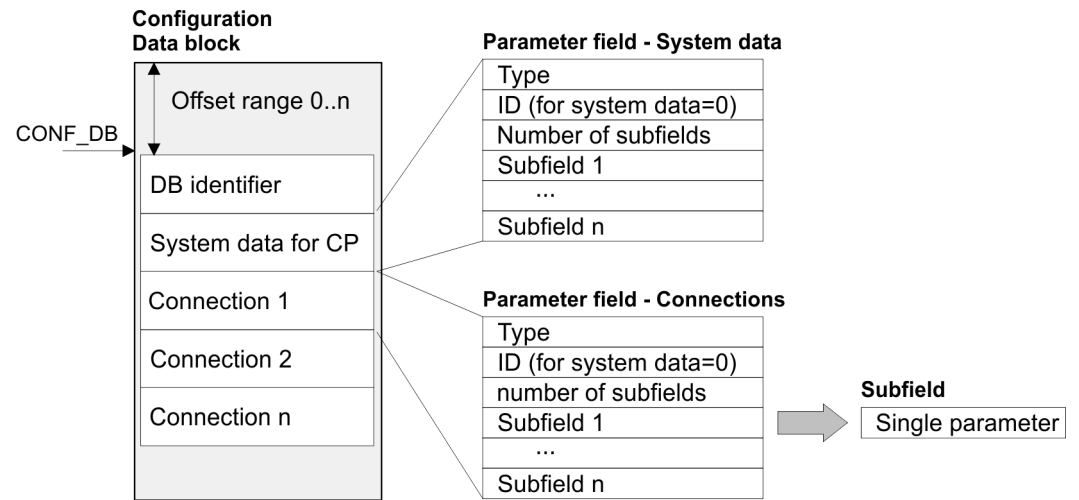

Parameter field for system data for CP

Below, there are the subfields that are relevant for networking the CP. These must be specified in the parameter field for system data. Some applications do not require all the subfield types.

Structure

Type = 0
ID = 0
Number of subfields = n
Subfield 1
Subfield 2
Subfield n

Subfield				Parameter	
ID	Type	Length (byte)	Description	Special features	Use
1	SUB_IP_V4	4 + 4	IP address of the local station according to IPv4		mandatory
2	SUB_NETMASK	4 + 4	Subnet mask of the local station		mandatory
4	SUB_DNS_SERV_ADDR	4 + 4	DNS Server Address	This subfield can occur to 4 times. The first entry is the primary DNS server.	optional
8	SUB_DEF_ROUTER	4 + 4	IP address of the default router		optional
14	SUB_DHCP_ENABLE	4 + 1	Obtain an IP address from a DHCP	0: no DHCP 1: DHCP	optional

Subfield				Parameter	
ID	Type	Length (byte)	Description	Special features	Use
15	SUB_CLIENT_ID	Length Client-ID + 4	-	-	optional
51	MAC-ADR	4 + 6	MAC address local node		optional

Parameter fields for Connections

There is shown below which values are needed to be entered in the parameter fields and which subfields are to be used for the various connection types. Some applications do not require all the subfield types. The ID parameter that precedes each connection parameter field beside the type ID is particularly important. On programmed connections this ID may freely be assigned within the permitted range of values. For identification of the connection this ID is to be used on the call interface of the FCs for the SEND/RECV.

Range of values for the connection ID: 1, 2 ... 64

TCP connection

Type = 1
ID = Connection ID
Number of subfields = n
Subfield 1
Subfield 2
Subfield n

Subfield				Parameter	
ID	Type	Length (byte)	Description	Special features	Use
1	SUB_IP_V4	4 + 4	IP address of the remote station according to IPv4		mandatory ¹
9	SUB_LOC_PORT	4 + 2	Port of the local station		mandatory
10	SUB_REM_PORT	4 + 2	Port of the remote station		mandatory ¹
18	SUB_CONNECT_NAME	Length Name + 4	Name of the connection		optional
19	SUB_LOC_MODE	4 + 1	Local mode of the connection, Possible values: 0x00 = SEND/REC 0x10 = S5-addressing mode for FETCH/ WRITE ² 0x80 = FETCH ² 0x40 = WRITE ² If you do not set the parameter, the default setting is SEND/RECV. For FETCH/WRITE a passive connection setup is necessary.		optional
21	SUB_KBUS_ADR	-	-	Value: fix 2	optional

Subfield				Parameter	
ID	Type	Length (byte)	Description	Special features	Use
22	SUB_CON_ESTABL	4 + 1	Type of connection establishment. With this option, you specify whether the connection is established by this station. Possible values: 0 = passive 1 = active		mandatory
1) Option using passive connection					
2) the coding may be combined with OR operations					

UDP connection

Type = 2
ID = Connection ID
Number of subfields = n
Subfield 1
Subfield 2
Subfield n

Subfield				Parameter	
ID	Type	Length (byte)	Description	Special features	Use
1	SUB_IP_V4	4 + 4	IP address of the remote station according to IPv4		mandatory
9	SUB_LOC_PORT	4 + 2	Port of the local station		mandatory
10	SUB_REM_PORT	4 + 2	Port of the remote station		mandatory
18	SUB_CON- NECT_NAME	Length Name + 4	Name of the connection		optional
19	SUB_LOC_MODE	4 + 1	Local mode of the connection Possible values: 0x00 = SEND/REC 0x10 = S5-addressing mode for FETCH/ WRITE ¹ 0x80 = FETCH ¹ 0x40 = WRITE ¹ If you do not set the parameter, the default setting is SEND/ RECV. For FETCH/WRITE a passive connection setup is necessary		optional
21	SUB_KBUS_ADR	-	-	Value: fix 2	optional

Subfield				Parameter	
ID	Type	Length (byte)	Description	Special features	Use
23	SUB_ADDR_IN_DATA_BLOCK	4 + 1	Select free UDP connection. The remote node is entered in the job header of the job buffer by the user program when it calls AG_SEND. This allows any node on Ethernet/LAN/WAN to be reached. Possible values: 1 = free UDP connection 0 = otherwise		optional

1) the coding may be combined with OR operations

ISO-on-TCP connection

Type = 3
ID = Connection ID
Number of subfields = n
Subfield 1
Subfield 2
Subfield n

Subfield				Parameter	
ID	Type	Length (byte)	Description	Special features	Use
1	SUB_IP_V4	4 + 4	IP address of the remote station according to IPv4		mandatory ¹
11	SUB_LOC_PORT	Length TSAP + 4	TSAP of the local station		mandatory
12	SUB_REM_PORT	Length TSAP + 4	TSAP of the remote station		mandatory ¹
18	SUB_CONNECT_NAME	Length Name + 4	Name of the connection		optional
19	SUB_LOC_MODE	4 + 1	Local mode of the connection Possible values: 0x00 = SEND/RECV 0x10 = S5-addressing mode for FETCH/WRITE ² 0x80 = FETCH ² 0x40 = WRITE ² If you do not set the parameter, the default setting is SEND/RECV. For FETCH/WRITE a passive connection setup is necessary		optional
21	SUB_KBUS_ADR	-	-	Value: fix 2	optional

Subfield				Parameter	
ID	Type	Length (byte)	Description	Special features	Use
22	SUB_CON_ESTABL	4 + 1	Type of connection establishment With this option, you specify whether the connection is established by this station. Possible values: 0 = passive 1 = active		mandatory
1) option using passive connection					
2) the coding may be combined with OR operation					

H1 connection (ISO)

Type = 10
ID = Connection ID
Number of subfields = n
Subfield 1
Subfield 2
Subfield n

Subfield				Parameter	
ID	Type	Length (byte)	Description	Special features	Use
51	SUB_MAC	4 + 6	MAC address of the remote station		mandatory
11	SUB_LOC_TSAP	Length TASP + 4	TSAP of the local station		mandatory
12	SUB_REM_TSAP	Length TASP + 4	TSAP of the remote station		mandatory ¹
18	SUB_CONNECT_NAME	Length Name + 4	Name of the connection		optional
19	SUB_LOC_MODE	4 + 1	Local mode of the connection Possible values: 0x00 = SEND/RECV 0x10 = S5-addressing mode for FETCH/WRITE ² 0x80 = FETCH ² 0x40 = WRITE ² If you do not set the parameter, the default setting is SEND/RECV. For FETCH/WRITE a passive connection setup is necessary		optional

Subfield				Parameter	
ID	Type	Length (byte)	Description	Special features	Use
22	SUB_CON_ESTABL	4 + 1	Type of connection establishment With this option, you specify whether the connection is established by this station. Possible values: 0 = passive; 1 = active		mandatory
52	SUB_TIME_CON_RETRAN	4 + 2	Time interval after which a failed connection is established again. (1...60s, default: 5s)	irrelevant with passive connection establishment	optional
53	SUB_TIME_DAT_RETRAN	4 + 2	Time interval after which a failed send is triggered again. (100...30000ms, default: 1000ms)		optional
54		4 + 2	Number of send attempts, incl 1. attempt(1...100, Default: 5)		optional
55		4 + 2	Time interval after which a connection is released, if there is no responds of the partner station.(6...160s, default: 30s)		optional

1) option using passive connection
2) the coding may be combined with OR operation

Siemens S7 connection

Type = 11
ID = Connection ID
Number of subfields = n
Subfield 1
Subfield 2
Subfield n

Subfield				Parameter	
ID	Type	Length (byte)	Description	Special features	Use
56	SUB_S/_C_DETAIL	4 + 14	Connection specific parameter		mandatory
18	SUB_CONNECT_NAME	LengthName + 4	Name of the connection		optional
1	SUB_IP_V4	4 + 4	IP address according to IPv4	IP address of the remote partner	mandatory ¹
51	SUB_MAC	4 + 6	MAC address of the remote station		mandatory

Subfield				Parameter	
ID	Type	Length (byte)	Description	Special features	Use
22	SUB_CON_ESTABL	4 + 1	Type of connection establishment. With this option, you specify whether the connection is established by this station. Possible values: 0 = passive 1 = active		mandatory
1) option using passive connection					

SUB_S/_C_DETAIL

Parameter	Declaration	Data type	Description
SubBlockID	IN	WORD	ID
SubBlockLen	IN	WORD	Length
TcpIpActive	IN	INT	Connection via MAC or IP address (MAC=0, IP=1)
LocalResource	IN	WORD	Local resource 0001h ... 00DFh (1=PG, 2=OP, 0010h ... 00DFh=not specified)
LocalRack	IN	WORD	Number local rack 0000h ... 0002h
LocalSlot	IN	WORD	Number local slot 0002h ... 000Fh (2=CPU, 4=VIPA-PG/OP, 5=CP int., 6=CP ext.)
RemoteResource	IN	WORD	Remote resource 0001h ... 00DFh (1=PG, 2=OP, 0010h ... 00DFh=not specified)
RemoteRack	IN	WORD	Number remote rack 0000h ... 0002h
RemoteSlot	IN	WORD	Number remote slot 0002h ... 000Fh (2=CPU, 4=VIPA-PG/OP, 5=CP int., 6=CP ext.)

The "local TSAP" is created with *LocalResource*, *LocalRack* and *LocalSlot*.

The "remote TSAP" is created with *RemoteResource*, *RemoteRack* and *RemoteSlot*.

Example for configuring a Siemens S7 connection

The configuration of a dynamic Siemens S7 connection via IP_CONF takes place analog to the configuration of a fix Siemens S7 connection with Siemens NetPro. Based on Siemens NetPro there are the following parameters corresponding to the following subfields:

Properties - Siemens S7- Connection	
Siemens NetPro	FB55 - IP_CONFIG
establish an active connection	SUB_CON_ESATBL.CON_ESTABL
TCP/IP	SUB_S7_C_DETAILS.TcpIpActive

Properties - Siemens S7- Connection	
Siemens NetPro	FB55 - IP_CONFIG
IP respectively MAC address remote station	SUB_IP_V4.rem_IP.IP_0...IP_3 resp. SUB_MAC.rem_MAC.MAC_0...MAC5
Local ID	Connection ID

Address details	
Siemens NetPro	FB55 - IP_CONFIG
Local rack	SUB_S7_C_DETAILS.LocalRack
Local slot	SUB_S7_C_DETAILS.LocalSlot
Local resource	SUB_S7_C_DETAILS.LocalResource
Remote rack	SUB_S7_C_DETAILS.RemoteRack
Remote slot	SUB_S7_C_DETAILS.RemoteSlot
Remote resource	SUB_S7_C_DETAILS.RemoteResource

Additional Parameter fields

Block_VIPA_HWK

As soon as the Block_VIPA_HWK (special identification 99) is contained in the DB, all connections, which were parameterized in the NETPRO, are still remain. Now it is possible to change with IP_CONFIG only the system data (IP, Netmask etc.). If the special identification Block_VIPA_HWK were found, no other connecting data may be parameterized in the DB, otherwise error is announced in the RETVAL. If the Block_VIPA_HWK is not in the DB, then all connections are removed from NETPRO (as with Siemens) and the connections from this DB are only configured.

Type = 99
ID = 0
Number of subfields = 0

Block_VIPA_BACNET

As soon as the Block_VIPA_BACNET (special identification 100) is contained in the DB, a BACNET configuration is derived from the DB and no further blocks are evaluated thereafter.

Type = 100
Number of subfields = 0

Block_VIPA_IPK

Type = 101
ID = Connection ID
Number of subfields = n
Subfield 1
Subfield 2
Subfield n

Subfield				Parameter	
ID	Type	Length (byte)	Description	Special features	Use
1	VIPA_IPK_CYCLE	4 + 4	IPK cycle time for connection ID	VIPA specific	optional

Example DB

Address	Name	Type	Initial value	Actual	Comment
0.0	DB_Ident	WORD	W#16#1	W#16#1	
2.0	Systemdaten.Typ	INT	0	0	System data
4.0	Systemdaten.Verbld	INT	0	0	fix 0
6.0	Systemdaten.SubBlock_Anzahl	INT	3	3	
8.0	Systemdaten.ip.SUB_IP_V4	WORD	W#16#1	W#16#1	
10.0	Systemdaten.ip.SUB_IP_V4_LEN	WORD	W#16#8	W#16#8	
12.0	Systemdaten.ip.IP_0	BYTE	B#16#0	B#16#AC	
13.0	Systemdaten.ip.IP_1	BYTE	B#16#0	B#16#14	
14.0	Systemdaten.ip.IP_2	BYTE	B#16#0	B#16#8B	
15.0	Systemdaten.ip.IP_3	BYTE	B#16#0	B#16#61	
16.0	Systemdaten.netmask.SUB_NETMASK	WORD	W#16#2	W#16#2	
18.0	Systemdaten.netmask.SUB_NETMASK_LEN	WORD	W#16#8	W#16#8	
20.0	Systemdaten.netmask.NETMASK_0	BYTE	B#16#0	B#16#FF	
21.0	Systemdaten.netmask.NETMASK_1	BYTE	B#16#0	B#16#FF	
22.0	Systemdaten.netmask.NETMASK_2	BYTE	B#16#0	B#16#FF	
23.0	Systemdaten.netmask.NETMASK_3	BYTE	B#16#0	B#16#0	
24.0	Systemdaten.router.SUB_DEF_ROUTER	WORD	W#16#8	W#16#8	
26.0	Systemdaten.router.SUB_DEF_ROUTER_LEN	WORD	W#16#8	W#16#8	
28.0	Systemdaten.router.ROUTER_0	BYTE	B#16#0	B#16#AC	
29.0	Systemdaten.router.ROUTER_1	BYTE	B#16#0	B#16#14	
30.0	Systemdaten.router.ROUTER_2	BYTE	B#16#0	B#16#8B	
31.0	Systemdaten.router.ROUTER_3	BYTE	B#16#0	B#16#61	
32.0	Con_TCP_ID1.Typ	INT	1	1	TCP connection
34.0	Con_TCP_ID1.Verbld	INT	0	1	Connection ID
36.0	Con_TCP_ID1.SubBlock_Anzahl	INT	4	4	
38.0	Con_TCP_ID1.ip1.SUB_IP_V4	WORD	W#16#1	W#16#1	
40.0	Con_TCP_ID1.ip1.SUB_IP_V4_LEN	WORD	W#16#8	W#16#8	
42.0	Con_TCP_ID1.ip1.IP_0	BYTE	B#16#0	B#16#AC	
43.0	Con_TCP_ID1.ip1.IP_1	BYTE	B#16#0	B#16#14	
44.0	Con_TCP_ID1.ip1.IP_2	BYTE	B#16#0	B#16#8B	
45.0	Con_TCP_ID1.ip1.IP_3	BYTE	B#16#0	B#16#62	
46.0	Con_TCP_ID1.locport.SUB_LOC_PORT	WORD	W#16#9	W#16#9	
48.0	Con_TCP_ID1.locport.SUB_LOC_PORT_LEN	WORD	W#16#6	W#16#6	
50.0	Con_TCP_ID1.locport.LOC_PORT	WORD	W#16#0	W#16#3E9	

Ethernet Communication > FB 55 - IP_CONF - Progr. Communication Connections

Address	Name	Type	Initial value	Actual	Comment
52.0	Con_TCP_ID1.remport.SUB_REM_PORT	WORD	W#16#A	W#16#A	
54.0	Con_TCP_ID1.remport.SUB_REM_PORT_LEN	WORD	W#16#6	W#16#6	
56.0	Con_TCP_ID1.remport.REM_PORT	WORD	W#16#0	W#16#3E9	
58.0	Con_TCP_ID1.con_est.SUB_CON_ESTABL	WORD	W#16#16	W#16#16	
60.0	Con_TCP_ID1.con_est.SUB_CON_ESTABL_LEN	WORD	W#16#6	W#16#6	
62.0	Con_TCP_ID1.con_est.CON_ESTABL	BYTE	B#16#0	B#16#1	
64.0	Con_ISO_ID3.Typ	INT	3	3	ISO-on-TCP connection
66.0	Con_ISO_ID3.VerblD	INT	0	3	Connection ID
68.0	Con_ISO_ID3.SubBlock_Anzahl	INT	4	4	
70.0	Con_ISO_ID3.ip1.SUB_IP_V4	WORD	W#16#1	W#16#1	
72.0	Con_ISO_ID3.ip1.SUB_IP_V4_LEN	WORD	W#16#8	W#16#8	
74.0	Con_ISO_ID3.ip1.IP_0	BYTE	B#16#0	B#16#AC	
75.0	Con_ISO_ID3.ip1.IP_1	BYTE	B#16#0	B#16#10	
76.0	Con_ISO_ID3.ip1.IP_2	BYTE	B#16#0	B#16#8B	
77.0	Con_ISO_ID3.ip1.IP_3	BYTE	B#16#0	B#16#62	
78.0	Con_ISO_ID3.loc_TSAP.SUB_LOC_PORT	WORD	W#16#B	W#16#B	
80.0	Con_ISO_ID3.loc_TSAP.SUB_LOC_PORT_LEN	WORD	W#16#A	W#16#A	
82.0	Con_ISO_ID3.loc_TSAP.LOC_TSAP[0]	BYTE	B#16#0	B#16#54	
83.0	Con_ISO_ID3.loc_TSAP.LOC_TSAP[1]	BYTE	B#16#0	B#16#53	
84.0	Con_ISO_ID3.loc_TSAP.LOC_TSAP[2]	BYTE	B#16#0	B#16#41	
85.0	Con_ISO_ID3.loc_TSAP.LOC_TSAP[3]	BYTE	B#16#0	B#16#50	
86.0	Con_ISO_ID3.loc_TSAP.LOC_TSAP[4]	BYTE	B#16#0	B#16#30	
87.0	Con_ISO_ID3.loc_TSAP.LOC_TSAP[5]	BYTE	B#16#0	B#16#31	
88.0	Con_ISO_ID3.rem_TSAP.SUB_REM_PORT	WORD	W#16#C	W#16#C	
90.0	Con_ISO_ID3.rem_TSAP.SUB_REM_PORT_LEN	WORD	W#16#A	W#16#A	
92.0	Con_ISO_ID3.rem_TSAP.REM_TSAP[0]	BYTE	B#16#0	B#16#54	
93.0	Con_ISO_ID3.rem_TSAP.REM_TSAP[1]	BYTE	B#16#0	B#16#53	
94.0	Con_ISO_ID3.rem_TSAP.REM_TSAP[2]	BYTE	B#16#0	B#16#41	
95.0	Con_ISO_ID3.rem_TSAP.REM_TSAP[3]	BYTE	B#16#0	B#16#50	
96.0	Con_ISO_ID3.rem_TSAP.REM_TSAP[4]	BYTE	B#16#0	B#16#30	
97.0	Con_ISO_ID3.rem_TSAP.REM_TSAP[5]	BYTE	B#16#0	B#16#31	
98.0	Con_ISO_ID3.con_est.SUB_CON_ESTABL	WORD	W#16#16	W#16#16	
100.0	Con_ISO_ID3.con_est.SUB_CON_ESTABL_LEN SUB_CON_ESTABL SUB_CON_ESTABL_LEN	WORD	W#16#6	W#16#6	
102.0	Con_ISO_ID3.con_est.CON_ESTABL	BYTE	B#16#0	B#16#1	
104.0	S7_Verb.Typ	INT	11	11	S7 connection
106.0	S7_Verb.VerblD	INT	0	0	Connection ID
108.0	S7_Verb.SubBlock_Anzahl	INT	5	5	
110.0	S7_Verb.VerblParameter.SUB_S7_C_DETAIL	INT	56	56	
112.0	S7_Verb.VerblParameter.SUB_S7_C_DETAIL_LEN	INT	18	18	
114.0	S7_Verb.VerblParameter.TcplpActive	INT	0	1	

Address	Name	Type	Initial value	Actual	Comment
116.0	S7_Verb.Verb_Parameter.LocalResource	INT	0	2	
118.0	S7_Verb.Verb_Parameter.LocalRack	INT	0	0	
120.0	S7_Verb.Verb_Parameter.LocalsSlot	INT	0	2	
122.0	S7_Verb.Verb_Parameter.RemoteResource	INT	0	2	
124.0	S7_Verb.Verb_Parameter.RemoteRack	INT	0	0	
126.0	S7_Verb.Verb_Parameter.RemoteSlot	INT	0	2	
128.0	S7_Verb.ipl.SUB_IP_V4	WORD	W#16#1	W#16#1	
130.0	S7_Verb.ipl.SUB_IP_V4_LEN	WORD	W#16#8	W#16#8	
132.0	S7_Verb.ipl.IP_0	BYTE	B#16#0	B#16#AC	
133.0	S7_Verb.ipl.IP_1	BYTE	B#16#0	B#16#10	
134.0	S7_Verb.ipl.IP_2	BYTE	B#16#0	B#16#8B	
135.0	S7_Verb.ipl.IP_3	BYTE	B#16#0	B#16#62	
136.0	S7_Verb.Mac.SUB_MAC	INT	51	51	
138.0	S7_Verb.Mac.SUB_MAC_LEN	INT	10	10	
140.0	S7_Verb.Mac.MAC_0	BYTE	B#16#0	B#16#0	
141.0	S7_Verb.Mac.MAC_1	BYTE	B#16#0	B#16#20	
142.0	S7_Verb.Mac.MAC_2	BYTE	B#16#0	B#16#D5	
143.0	S7_Verb.Mac.MAC_3	BYTE	B#16#0	B#16#77	
144.0	S7_Verb.Mac.MAC_4	BYTE	B#16#0	B#16#53	
145.0	S7_Verb.Mac.MAC_5	BYTE	B#16#0	B#16#9B	
146.0	S7_Verb.con_est.SUB_CON_ESTABL	WORD	W#16#16	W#16#16	
148.0	S7_Verb.con_est.SUB_CON_ESTABL_LEN	WORD	W#16#6	W#16#6	
150.0	S7_Verb.con_est.CON_ESTABL	BYTE	B#16#0	B#16#1	
152.0	S7_Verb.name_verb.SUB_CONNECT_NAME	WORD	W#16#12	W#16#12	
154.0	S7_Verb.name_verb.SUB_CONNECT_NAME_LEN	WORD	W#16#23	W#16#23	
156.0	S7_Verb.name_verb.CONNECT_NAME[0]	CHAR	''	'V'	Connection S7 with IP-Config 1
157.0	S7_Verb.name_verb.CONNECT_NAME[1]	CHAR	''	'e'	
158.0	S7_Verb.name_verb.CONNECT_NAME[2]	CHAR	''	'r'	
159.0	S7_Verb.name_verb.CONNECT_NAME[3]	CHAR	''	'b'	
160.0	S7_Verb.name_verb.CONNECT_NAME[4]	CHAR	''	'l'	
161.0	S7_Verb.name_verb.CONNECT_NAME[5]	CHAR	''	'n'	
162.0	S7_Verb.name_verb.CONNECT_NAME[6]	CHAR	''	'd'	
163.0	S7_Verb.name_verb.CONNECT_NAME[7]	CHAR	''	'u'	
164.0	S7_Verb.name_verb.CONNECT_NAME[8]	CHAR	''	'n'	
165.0	S7_Verb.name_verb.CONNECT_NAME[9]	CHAR	''	'g'	
166.0	S7_Verb.name_verb.CONNECT_NAME[10]	CHAR	''	''	
167.0	S7_Verb.name_verb.CONNECT_NAME[11]	CHAR	''	'S'	
168.0	S7_Verb.name_verb.CONNECT_NAME[12]	CHAR	''	'7'	
169.0	S7_Verb.name_verb.CONNECT_NAME[13]	CHAR	''	''	
170.0	S7_Verb.name_verb.CONNECT_NAME[14]	CHAR	''	'm'	
171.0	S7_Verb.name_verb.CONNECT_NAME[15]	CHAR	''	'l'	

Ethernet Communication > FB 55 - IP_CONF - Progr. Communication Connections

Address	Name	Type	Initial value	Actual	Comment
172.0	S7_Verb.name_verb.CONNECT_NAME[16]	CHAR	''	't'	
173.0	S7_Verb.name_verb.CONNECT_NAME[17]	CHAR	''	''	
174.0	S7_Verb.name_verb.CONNECT_NAME[18]	CHAR	''	'l'	
175.0	S7_Verb.name_verb.CONNECT_NAME[19]	CHAR	''	'P'	
176.0	S7_Verb.name_verb.CONNECT_NAME[20]	CHAR	''	'.'	
177.0	S7_Verb.name_verb.CONNECT_NAME[21]	CHAR	''	'C'	
178.0	S7_Verb.name_verb.CONNECT_NAME[22]	CHAR	''	'o'	
179.0	S7_Verb.name_verb.CONNECT_NAME[23]	CHAR	''	'n'	
180.0	S7_Verb.name_verb.CONNECT_NAME[24]	CHAR	''	'f'	
181.0	S7_Verb.name_verb.CONNECT_NAME[25]	CHAR	''	'l'	
182.0	S7_Verb.name_verb.CONNECT_NAME[26]	CHAR	''	'g'	
183.0	S7_Verb.name_verb.CONNECT_NAME[27]	CHAR	''	''	
184.0	S7_Verb.name_verb.CONNECT_NAME[28]	CHAR	''	'1'	
185.0	S7_Verb.name_verb.CONNECT_NAME[29]	CHAR	''	''	
186.0	S7_Verb.name_verb.CONNECT_NAME[30]	CHAR	''	''	

9 Modbus Communication

Block library "Modbus Communication"

The block library can be found for download in the 'Service/Support' area of www.vipa.com at 'Downloads → VIPA Lib' as 'Block library Modbus Communication - SW90AS0MA'. The library is available as packed zip file. As soon as you want to use these blocks you have to import them into your project. ↪ *Chap. 5 'Include VIPA library' page 69*

9.1 TCP

9.1.1 FB 70 - TCP_MB_CLIENT - Modbus/TCP client

9.1.1.1 Description

This function allows the operation of an Ethernet interface as Modbus/TCP client.

Call parameter

Name	Declaration	Type	Description
REQ	IN	BOOL	Start job with edge 0-1.
ID	IN	WORD	ID from TCON.
MB_FUNCTION	IN	BYTE	Modbus: <i>Function code</i> .
MB_DATA_ADDR	IN	WORD	Modbus: Start address or <i>sub function code</i> .
MB_DATA_LEN	IN	INT	Modbus: Number of register/bits.
MB_DATA_PTR	IN	ANY	Modbus: Data buffer (only flag area or data block of data type byte allowed) for access with <i>function code 03h, 06h and 10h</i> .
DONE *	OUT	BOOL	Job finished without error.
BUSY	OUT	BOOL	Job is running.
ERROR *	OUT	BOOL	Job is ready with error - parameter STATUS has error information.
STATUS *	OUT	WORD	Extended status and error information.

*) Parameter is available until the next call of the FB

Parameter in instance DB

Name	Declaration	Type	Description
PROTOCOL_TIMEOUT	STAT	INT	Blocking time before an active job can be cancelled by the user. Default: 3s
RCV_TIMEOUT	STAT	INT	Monitoring time for a job. Default: 2s
MB_TRANS_ID	STAT	WORD	Modbus: Start value for the transaction identifier. Default: 1
MB_UNIT_ID	STAT	BYTE	Modbus: Device identification. Default: 255

TCP > FB 70 - TCP_MB_CLIENT - Modbus/TCP client

The following must be observed:

- The *call parameters* must be specified with the block call. Besides the *call parameters* all parameters are located in the instance DB.
- The communication link must be previously initialized via FB 65 (TCON).
- FB 63 (TSEND) and FB 64 (TRCV) are required for the use of the block.
- During a job processing the instance DB is blocked for other clients.
- During job processing changes to the input parameters are not evaluated.
- With the following conditions a job processing is completed or cancelled:
 - DONE = 1 job without error
 - ERROR = 1 job with error
 - Expiration of RCV_TIMEOUT
 - REQ = FALSE after expiration of PROTOCOL_TIMEOUT
- REQ is reset before DONE or ERROR is set or PROTOCOL_TIMEOUT has expired, STATUS 8200h is reported. Here the current job is still processed.

Status and error indication The function block reports via STATUS the following status and error information.

STATUS	DONE	BUSY	ERROR	Description
0000h	1	0	0	Operation executed without error.
7000h	0	0	0	No connection established or communication error (TCON).
7004h	0	0	0	Connection established and monitored. No job active.
7005h	0	1	0	Data are sent.
7006h	0	1	0	Data are received.
8210h	0	0	1	The hardware is incompatible with the block library Modbus RTU/TCP.
8380h	0	0	1	Received Modbus frame does not have the correct format or has an invalid length.
8381h	0	0	1	Server returns <i>Exception code 01h</i> .
8382h	0	0	1	Server returns <i>Exception code 03h</i> or wrong start address.
8383h	0	0	1	Server returns <i>Exception code 02h</i> .
8384h	0	0	1	Server returns <i>Exception code 04h</i> .
8386h	0	0	1	Server returns wrong <i>Function code</i> .
8387h	0	0	1	Connection ID (TCON) does not match the instance or server returns wrong protocol ID.
8388h	0	0	1	Server returns wrong value or wrong quantity.
80C8h	0	0	1	No answer of the server during the duration (RCV_TIMEOUT).
8188h	0	0	1	MB_FUNCTION not valid.
8189h	0	0	1	MB_DATA_ADDR not valid.
818Ah	0	0	1	MB_DATA_LEN not valid.
818Bh	0	0	1	MB_DATA_PTR not valid.
818Ch	0	0	1	BLOCKED_PROC_TIMEOUT or RCV_TIMEOUT not valid.

STATUS	DONE	BUSY	ERROR	Description
818Dh	0	0	1	Server returns wrong transaction ID.
8200h	0	0	1	Another Modbus request is processed at the time via the port (PROTOCOL_TIMEOUT).

9.1.1.2 Example

Task

With *Function code 03h*, starting from address 2000, 100 register are to be read from a Modbus/TCP server and stored in flag area starting from MB200. Errors are to be stored.

OB1

```

CALL FB 65 , DB65
  REQ      :=M100.0
  ID       :=W#16#1
  DONE     :=M100.1
  BUSY     :=
  ERROR    :=M100.2
  STATUS   :=MW102
  CONNECT:=P#DB255.DBX 0.0 BYTE 64





UN  M  100.2
SPB ERR1
L   MW 102
T   MW 104
ERR1: NOP 0
U   M  100.1
R   M  100.0

CALL FB 70 , DB70
  REQ      :=M101.0
  ID       :=W#16#1
  MB_FUNCTION :=B#16#3
  MB_DATA_ADDR:=W#16#7D0
  MB_DATA_LEN :=100
  MB_DATA_PTR :=P#M 200.0 BYTE 200
  DONE     :=M101.1
  BUSY     :=
  ERROR    :=M101.2
  STATUS   :=MW106

UN  M  101.2
SPB ERR2
L   MW 106
T   MW 108
ERR2: NOP 0
U   M  101.1
R   M  101.0

```

OB1 - Description

1.  Calling of FB 65 (TCON) to establish a communication connection with the partner station.
2.  Calling the handling block of the Modbus/TCP client with the correct parameters.
3.  There is no connection to the partner station and MW102 returns 7000h.
4.  Set M100.0 in the CPU to TRUE.
 - ⇒ If M100.0 is automatically reset, the connection to the partner station is established and MW108 returns 7004h.

TCP > FB 71 - TCP_MB_SERVER - Modbus/TCP server

5. → Set M101.0 in the CPU to TRUE.

⇒ The Modbus request is sent and it is waited for a response.

If M101.0 is automatically reset, the job was finished without errors and the read data are stored in the CPU starting from bit memory byte 200. MW108 returns 7004h and indicates waiting for a new job.

If M101.0 is not automatically reset and MW108 returns non-zero, an error has occurred. The cause of error can be read by the code of MW108 (e.g. MW108 = 8382h when the start address 2000 in the server is not available). MW108 returns 7004h and indicates waiting for a new job.

9.1.2 FB 71 - TCP_MB_SERVER - Modbus/TCP server**9.1.2.1 Description**

This function allows the operation of an Ethernet interface as Modbus/TCP server.

Call parameter

Name	Declaration	Type	Description
ENABLE	IN	BOOL	Activation/Deactivation Modbus server.
MB_DATA_PTR	IN	ANY	Modbus: Data buffer (only flag area or data block of type Byte allowed) for access with <i>function code 03h, 06h and 10h</i> .
ID	IN	WORD	ID from TCON.
NDR*	OUT	BOOL	New data were written by the Modbus client.
DR*	OUT	BOOL	Data were read by the Modbus client.
ERROR*	OUT	BOOL	Job is ready with error - parameter STATUS has error information.
STATUS*	OUT	WORD	Extended status and error information.

*) Parameter is available until the next call of the FB

Parameter in instance DB

Name	Declaration	Type	Description
REQUEST_COUNT	STAT	WORD	Counter for each received frame.
MESSAGE_COUNT	STAT	WORD	Counter for each valid Modbus request.
XMT_RCV_COUNT	STAT	WORD	Counter for each received frame, which contains no valid Modbus request.
EXCEPTION_COUNT	STAT	WORD	Counter for each negatively acknowledged Modbus request.
SUCCESS_COUNT	STAT	WORD	Counter for each positively acknowledged Modbus request.
FC1_ADDR_OUTPUT_START	STAT	WORD	Modbus <i>Function code 01h</i> start register for Q0.0 Default: 0

Name	Declaration	Type	Description
FC1_ADDR_OUTPUT_END	STAT	WORD	Modbus <i>Function code 01h</i> end register for Qx.y Default: 19999
FC1_ADDR_MEMORY_START	STAT	WORD	Modbus <i>Function code 01h</i> start register for M0.0 Default: 20000
FC1_ADDR_MEMORY_END	STAT	WORD	Modbus <i>Function code 01h</i> end register for Mx.y Default: 39999
FC2_ADDR_INPUT_START	STAT	WORD	Modbus <i>Function code 02h</i> start register for I0.0 Default: 0
FC2_ADDR_INPUT_END	STAT	WORD	Modbus <i>Function code 02h</i> end register for Ix.y Default: 19999
FC2_ADDR_MEMORY_START	STAT	WORD	Modbus <i>Function code 02h</i> start register for M0.0 Default: 20000
FC2_ADDR_MEMORY_END	STAT	WORD	Modbus <i>Function code 02h</i> end register for Mx.y Default: 39999
FC4_ADDR_INPUT_START	STAT	WORD	Modbus <i>Function code 04h</i> start register for IW0 Default: 0
FC4_ADDR_INPUT_END	STAT	WORD	Modbus <i>Function code 04h</i> end register for IWx Default: 19999
FC4_ADDR_MEMORY_START	STAT	WORD	Modbus <i>Function code 04h</i> start register for MW0 Default: 20000
FC4_ADDR_MEMORY_END	STAT	WORD	Modbus <i>Function code 04h</i> end register for MWx Default: 39999
FC5_ADDR_OUTPUT_START	STAT	WORD	Modbus <i>Function code 05h</i> start register for Q0.0 Default: 0
FC5_ADDR_OUTPUT_END	STAT	WORD	Modbus <i>Function code 05h</i> end register for Qx.y Default: 19999
FC5_ADDR_MEMORY_START	STAT	WORD	Modbus <i>Function code 05h</i> start register for M0.0 Default: 20000
FC5_ADDR_MEMORY_END	STAT	WORD	Modbus <i>Function code 05h</i> end register for Mx.y Default: 39999
FC15_ADDR_OUTPUT_START	STAT	WORD	Modbus <i>Function code 0Fh</i> start register for Q0.0 Default: 0
FC15_ADDR_OUTPUT_END	STAT	WORD	Modbus <i>Function code 0Fh</i> end register for Qx.y Default: 19999

TCP > FB 71 - TCP_MB_SERVER - Modbus/TCP server

Name	Declaration	Type	Description
FC15_ADDR_MEMORY_START	STAT	WORD	Modbus <i>Function code 0Fh</i> start register for Q0.0 Default: 20000
FC15_ADDR_MEMORY_END	STAT	WORD	Modbus <i>Function code 0Fh</i> end register for Qx.y Default: 39999

The following must be observed:

- The *call parameters* must be specified with the block call. Besides the *call parameters* all parameters are located in the instance DB.
- The communication link must be previously initialized via FB 65 (TCON).
- FB 63 (TSEND) and FB 64 (TRCV) are required for the use of the block.
- The INPUT/OUTPUT Modbus addresses of a *Function code* must be located in front of the MEMORY Modbus address and thus always be lower.
- Within a *Function code* no Modbus address may be defined multiple times - also not 0!
- The server can only process one job simultaneously. New Modbus requests during job processing are ignored and not answered.

Status and error indication The function block reports via *STATUS* the following status and error information.

STATUS	NDR	DR	ERROR	Description
0000h	0 or 1*		0	Operation executed without error.
7000h	0	0	0	No connection established or communication error (TCON).
7005h	0	0	0	Data are sent.
7006h	0	0	0	Data are received.
8210h	0	0	1	The hardware is incompatible with the block library Modbus RTU/TCP.
8380h	0	0	1	Received Modbus frame does not have the correct format or bytes are missing.
8381h	0	0	1	<i>Exception code 01h</i> , <i>Function code</i> is not supported.
8382h	0	0	1	<i>Exception code 03h</i> , data length or data value are not valid.
8383h	0	0	1	<i>Exception code 02h</i> , invalid start address or address range.
8384h	0	0	1	<i>Exception code 04h</i> , area length error when accessing inputs, outputs or bit memories.
8387h	0	0	1	Connection ID (TCON) does not match the instance or client returns wrong protocol ID.
8187h	0	0	1	MB_DATA_PTR not valid.

*) Error free Modbus job with *Function code 05h, 06h, 0Fh or 10h* returns NDR=1 and DR=0.

Error free Modbus job with *Function code 01h, 02h, 03h, 04h* return DR=1 and NDR=0.

9.1.2.2 Example

Task

The CPU provides 100 byte data in the flag area starting from MB200 for a Modbus client via the Modbus register 0...49. Data can be read from the Modbus client via *Function code 03h* and written with *Function code 06h, 10h*. The CPU output Q1.0 is to be controlled by a Modbus client via *Function code 05h* and the start address 5008. Errors are to be stored.

OB1

```

CALL FB    65 , DB65
   REQ    :=M100.0
   ID     :=W#16#1
   DONE   :=M100.1
   BUSY   :=
   ERROR  :=M100.2
   STATUS :=MW102
   CONNECT:=P#DB255.DBX 0.0 BYTE 64

UN      M    100.2
SPB     ERR1

L       MW    102
T       MW    104

ERR1: NOP  0
U       M    100.1
R       M    100.0

L       5000
T       DB71.DBW  52

CALL FB    71 , DB71
   ENABLE :=M101.0
   MB_DATA_PTR:=P#M 200.0 BYTE 100
   ID     :=W#16#1
   NDR    :=M101.1
   DR     :=M101.2
   ERROR  :=M101.3
   STATUS :=MW106







UN      M    101.3
SPB     ERR2

L       MW    106
T       MW    108

ERR2: NOP  0

```

OB1 - Description

1.  Call of FB 65 (TCON) to establish a communication connection with the partner station.
2.  Calling the handling block of the Modbus/TCP server with the correct parameters.
3.  There is no connection to the partner station and MW102 returns 7000h.
4.  Set M100.0 in the CPU to TRUE.
 - ⇒ If M100.0 is automatically reset, the connection to the partner station is established and MW108 returns 7006h.
5.  The Modbus start register in the process image, which can be reached by *Function code 05h*, may be changed in the example by the parameter FC5_ADDR_OUTPUT_START (word 52 in the instance data block).
6.  Set M101.0 in the CPU to TRUE.
 - ⇒ The Modbus server now works.
7.  The client sends a Modbus request with *Function code 03h* start address 10 and quantity 30.

RTU > FB 72 - RTU_MB_MASTER - Modbus RTU master

- ⇒ The server responds with 60 byte starting from MB220. DR is set for one CPU cycle and thus M101.2 is set to "1".
- 8. ➤ The client sends a Modbus request with *Function code 05h* start address 5008 and the value FF00h.
 - ⇒ The server acknowledges the request and writes "1" to the output Q1.0. NDR is set for one CPU cycle and thus M101.1 is set to "1".
- 9. ➤ The client sends a Modbus request with *Function code 03h* start address 50 (does not exist) and quantity 1.
 - ⇒ The server responds with *Exception code 02h* and sets ERROR/STATUS for one CPU cycle. MW108 returns 8383h.

9.2 RTU

9.2.1 FB 72 - RTU_MB_MASTER - Modbus RTU master

9.2.1.1 Description

This function block allows the operation of the internal serial RS485 interface of a SPEED7 CPU from VIPA or a System SLIO CP 040 as Modbus RTU master.

Call parameter

Name	Declaration	Type	Description
REQ	IN	BOOL	Start job with edge 0-1.
HARDWARE	IN	BYTE	1 = System SLIO CP 040 / 2 = VIPA SPEED7 CPU
LADDR	IN	INT	Logical address of the System SLIO CP 040 (parameter is ignored with the VIPA SPEED7 CPU).
MB_UNIT_ID	IN	BYTE	Modbus: Device identification = Address of the slave (0 ... 247).
MB_FUNCTION	IN	BYTE	Modbus: <i>Function code</i> .
MB_DATA_ADDR	IN	WORD	Modbus: Start address or <i>Sub function code</i> .
MB_DATA_LEN	IN	INT	Modbus: Number of register/bits.
MB_DATA_PTR	IN	ANY	Modbus: Data buffer (only flag area or data block of data type byte allowed) for access with <i>function code 03h, 06h and 10h</i> .
DONE*	OUT	BOOL	Job finished without error.
BUSY	OUT	BOOL	Job is running.
ERROR*	OUT	BOOL	Job is ready with error - parameter <i>STATUS</i> has error information.
STATUS*	OUT	WORD	Extended status and error information.

*) Parameter is available until the next call of the FB

Parameter in instance DB

Name	Declaration	Type	Description
INIT	STAT	BOOL	With an edge 0-1 an synchronous reset is established at the System SLIO CP 040. After a successful reset the bit automatically reset.

The following must be observed:

- The *call parameters* must be specified with the block call. Besides the *call parameters* all parameters are located in the instance DB.
- The interface to be used must be configured before:
 - VIPA System SLIO CP 040: Configuration as "Modbus master RTU" with 60 byte IO-Size in the hardware configuration.
 - Internal serial RS485 interface of a VIPA CPU: Configuration via SFC 216 (SER_CFG) with protocol "Modbus master RTU".
- FB 60 SEND and FB 61 RECEIVE (or FB 65 SEND_RECV) are required for the use of the block, even if the internal serial RS485 interface of a CPU from VIPA is used.
- During job processing changes to the input parameters are not evaluated.
- Broadcast request via MB_UNIT_ID = 0 are only accepted for writing functions.
- With the following conditions a job processing is completed or cancelled:
 - DONE = 1 job without error
 - ERROR = 1 job with error
 - Expiration of time-out (parameterization at the interface)
- If REQ is reset before DONE or ERROR is set, STATUS 8200h is reported. Here the current job is still processed.

Status and error indication The function block reports via STATUS the following status and error information.

STATUS	DONE	BUSY	ERROR	Description
0000h	1	0	0	Operation executed without error.
7000h	0	0	0	No connection established or communication error.
7004h	0	0	0	Connection established and monitored. No job active.
7005h	0	1	0	Data are sent.
7006h	0	1	0	Data are received.
8210h	0	0	1	The hardware is incompatible with the block library Modbus RTU/TCP.
8381h	0	0	1	Server returns <i>Exception code 01h</i> .
8382h	0	0	1	Server returns <i>Exception code 03h</i> or wrong start address.
8383h	0	0	1	Server returns <i>Exception code 02h</i> .
8384h	0	0	1	Server returns <i>Exception code 04h</i> .
8386h	0	0	1	Server returns wrong <i>Function code</i> .
8388h	0	0	1	Server returns wrong value or quantity.
80C8h	0	0	1	No answer of the server during the defined duration (time-out parameterizable via interface).
8188h	0	0	1	MB_FUNCTION not valid.
8189h	0	0	1	MB_DATA_ADDR not valid.
818Ah	0	0	1	MB_DATA_LEN not valid.
818Bh	0	0	1	MB_DATA_PTR not valid.
8201h	0	0	1	HARDWARE not valid.
8202h	0	0	1	MB_UNIT_ID not valid.
8200h	0	0	1	Another Modbus request is processed at the time via the port.

RTU > FB 72 - RTU_MB_MASTER - Modbus RTU master

9.2.1.2 Example



Task

With *Function code 03h*, starting from address 2000, 100 register are to be read from a Modbus RTU slave with address 99 and stored in flag area starting from MB200. Errors are to be stored. The Modbus RTU master is realized via the internal serial RS485 interface of a VIPA CPU.

OB100

```
CALL SFC 216
    Protocol :=B#16#5
    Parameter :=DB10
    Baudrate:=B#16#9
    CharLen:=B#16#3
    Parity:=B#16#2
    StopBits:=B#16#1
    FlowControl:=B#16#1
    RetVal:=MW100
```

OB100 - Description



1.  Calling of the SFC 216 (SER_CFG) to configure the internal serial interface of the CPU from VIPA.
2.  Protocol: "Modbus Master RTU", 9600 baud, 8 data bit, 1 stop bit, even parity, no flow control.
3.  DB10 has a variable of type WORD with a Modbus time-out (value in ms).

OB1

```
CALL FB 72 , DB72
    REQ           :=M101.0
    HARDWARE      :=B#16#2
    LADDR         :=
    MB_UNIT_ID    :=B#16#63
    MB_FUNCTION   :=B#16#3
    MB_DATA_ADDR :=W#16#7D0
    MB_DATA_LEN   :=100
    MB_DATA_PTR  :=P#M 200.0 BYTE 200
    DONE         :=M101.1
    BUSY         :=
    ERROR        :=M101.2
    STATUS       :=MW102

    UN   M   101.2
    SPB  ERR1
    L    MW  102
    T    MW  104
ERR1:  NOP  0
    U    M   101.1
    R    M   101.0
```

OB1 - Description

1.  Calling the handling block of the Modbus RTU master with the correct parameters.
2.  If the interface was correctly initialized in the OB 100, the master can be used and MW102 returns 7004h.

3. Set M101.0 in the CPU to TRUE.

⇒ The Modbus request is sent and it is waited for a response.

If M101.0 is automatically reset, the job was finished without errors and the read data are stored in the CPU starting from bit memory byte 200. MW104 returns 7004h and indicates waiting for a new job.

If M101.0 is not automatically reset and MW104 returns non-zero, an error has occurred. The cause of error can be read by the code of MW104 (e.g. MW104 = 8382h when the start address 2000 in the server is not available). MW102 returns 7004h and indicates waiting for a new job.

9.2.2 FB 73 - RTU_MB_SLAVE - Modbus RTU slave**9.2.2.1 Description**

This function block allows the operation of the internal serial RS485 interface of a SPEED7 CPU from VIPA or a System SLIO CP 040 as Modbus RTU slave.

Call parameter

Name	Declaration	Type	Description
ENABLE	IN	BOOL	Activation/Deactivation Modbus server.
HARDWARE	IN	BYTE	1 = System SLIO CP 040 / 2 = VIPA SPEED7 CPU
LADDR	IN	INT	Logical address of the System SLIO CP 040 (parameter is ignored with the VIPA SPEED7 CPU).
MB_UNIT_ID	IN	BYTE	Modbus: Device identification = own address (1 ... 247).
MB_DATA_PTR	IN	ANY	Modbus: Data buffer (only flag area or data block of data type byte allowed) for access with <i>function code 03h, 06h and 10h</i> .
NDR*	OUT	BOOL	New data were written by the Modbus client.
DR*	OUT	BOOL	Data were read by the Modbus client.
ERROR*	OUT	BOOL	Job is ready with error - parameter <i>STATUS</i> has error information.
STATUS*	OUT	WORD	Extended status and error information.

*) Parameter is available until the next call of the FB

Parameter in instance DB

Name	Declaration	Type	Description
INIT	STAT	BOOL	With an edge 0-1 an synchronous reset is established at the System SLIO CP 040.
REQUEST_COUNT	STAT	WORD	Counter for each received frame.
MESSAGE_COUNT	STAT	WORD	Counter for each valid Modbus request.
BROADCAST_COUNT	STAT	WORD	Counter for each valid Modbus broadcast request.

RTU > FB 73 - RTU_MB_SLAVE - Modbus RTU slave

Name	Declaration	Type	Description
EXCEPTION_COUNT	STAT	WORD	Counter for each negatively acknowledged Modbus request.
SUCCESS_COUNT	STAT	WORD	Counter for each positively acknowledged Modbus request.
BAD_CRC_COUNT	STAT	WORD	Counter for each valid Modbus request with CRC error.
FC1_ADDR_OUTPUT_START	STAT	WORD	Modbus <i>Function code 01h</i> start register for Q0.0 Default: 0
FC1_ADDR_OUTPUT_END	STAT	WORD	Modbus <i>Function code 01h</i> end register for Qx.y Default: 19999
FC1_ADDR_MEMORY_START	STAT	WORD	Modbus <i>Function code 01h</i> start register for M0.0 Default: 20000
FC1_ADDR_MEMORY_END	STAT	WORD	Modbus <i>Function code 01h</i> end register for Mx.y Default: 39999
FC2_ADDR_INPUT_START	STAT	WORD	Modbus <i>Function code 02h</i> start register for I0.0 Default: 0
FC2_ADDR_INPUT_END	STAT	WORD	Modbus <i>Function code 02h</i> end register for Ix.y Default: 19999
FC2_ADDR_MEMORY_START	STAT	WORD	Modbus <i>Function code 02h</i> start register for M0.0 Default: 20000
FC2_ADDR_MEMORY_END	STAT	WORD	Modbus <i>Function code 02h</i> end register for Mx.y Default: 39999
FC4_ADDR_INPUT_START	STAT	WORD	Modbus <i>Function code 04h</i> start register for IW0 Default: 0
FC4_ADDR_INPUT_END	STAT	WORD	Modbus <i>Function code 04h</i> end register for IWx Default: 19999
FC4_ADDR_MEMORY_START	STAT	WORD	Modbus <i>Function code 04h</i> start register for MW0 Default: 20000
FC4_ADDR_MEMORY_END	STAT	WORD	Modbus <i>function-Code 04 h</i> end register for MW0 Default: 39999
FC5_ADDR_OUTPUT_START	STAT	WORD	Modbus <i>Function code 05h</i> start register for Q0.0 Default: 0
FC5_ADDR_OUTPUT_END	STAT	WORD	Modbus <i>Function code 05h</i> end register for Qx.y Default: 19999
FC5_ADDR_MEMORY_START	STAT	WORD	Modbus <i>Function code 05h</i> start register for M0.0 Default: 20000
FC5_ADDR_MEMORY_END	STAT	WORD	Modbus <i>Function code 05h</i> end register for Mx.y Default: 39999

Name	Declaration	Type	Description
FC15_ADDR_OUTPUT_START	STAT	WORD	Modbus <i>Function code 0Fh</i> start register for Q0.0 Default: 0
FC15_ADDR_OUTPUT_END	STAT	WORD	Modbus <i>Function code 0Fh</i> end register for Qx.y Default: 19999
FC15_ADDR_MEMORY_START	STAT	WORD	Modbus <i>Function code 0Fh</i> start register for M0.0 Default: 20000
FC15_ADDR_MEMORY_END	STAT	WORD	Modbus <i>Function code 0Fh</i> end register for Mx.y Default: 39999

The following must be observed:

- The *call parameters* must be specified with the block call. Besides the *call parameters* all parameters are located in the instance DB.
- The interface to be used must be configured before:
 - VIPA System SLIO CP 040: Configuration as ASCII module with 60 byte IO-Size in the hardware configuration.
 - Internal serial RS485 interface of a VIPA CPU:
Configuration via SFC 216 (SER_CFG) with protocol "ASCII".
- FB 60 SEND and FB 61 RECEIVE (or FB 65 SEND_RECV) are required for the use of the block, even if the internal serial RS485 interface of a CPU from VIPA is used.
- Broadcast request via MB_UNIT_ID = 0 are only accepted for writing functions.
- The INPUT/OUTPUT Modbus addresses of a *Function code* must be located in front of the MEMORY Modbus address and thus always be lower.
- Within a *Function code* no Modbus address may be defined multiple times - also not 0!
- The slave can only process one job simultaneously. New Modbus requests during job processing are ignored and not answered.

Status and error indication The function block reports via STATUS the following status and error information.

STATUS	NDR	DR	ERROR	Description
0000h	0 or 1*		0	Operation executed without error.
7000h	0	0	0	No connection established or communication error.
7005h	0	0	0	Data are sent.
7006h	0	0	0	Data are received.
8210h	0	0	1	The hardware is incompatible with the block library Modbus RTU/TCP.
8380h	0	0	1	CRC error
8381h	0	0	1	<i>Exception code 01h</i> , <i>Function code</i> is not supported.
8382h	0	0	1	<i>Exception code 03h</i> , data length or data value are not valid.
8383h	0	0	1	<i>Exception code 02h</i> , invalid start address or address range.
8384h	0	0	1	<i>Exception code 04h</i> , area length error when accessing inputs, outputs or bit memories.
8187h	0	0	1	MB_DATA_PTR not valid.

RTU > FB 73 - RTU_MB_SLAVE - Modbus RTU slave

STATUS	NDR	DR	ERROR	Description
8201h	0	0	1	HARDWARE not valid.
8202h	0	0	1	MB_UNIT_ID not valid.
8203 h	0	0	1	

*) Error free Modbus job with *Function code 05h, 06h, 0Fh or 10h* returns NDR=1 and DR=0.

Error free Modbus job with *Function code 01h, 02h, 03h, 04h* return DR=1 and NDR=0.

9.2.2.2 Example

Task

The CPU provides 100 byte data in the flag area starting from MB200 for a Modbus master via the Modbus register 0 ... 49. Data can be read by the Modbus master via *Function code 03h* and written with *Function code 06h, 10h*. The CPU output Q1.0 is to be controlled by a Modbus master via *Function code 05h* and the start address 5008. Errors are to be stored. The Modbus RTU slave with the address 99 is realized via the internal serial RS485 interface of a VIPA CPU.

OB100

```
CALL SFC 216
  Protocol :=B#16#1
  Parameter :=DB10
  Baudrate:=B#16#9
  CharLen:=B#16#3
  Parity:=B#16#2
  StopBits:=B#16#1
  FlowControl:=B#16#1
  RetVal:=MW100
```

OB100 - Description

1. Calling of the SFC 216 (SER_CFG) to configure the internal serial interface of the CPU from VIPA.
2. Protocol: "ASCII", 9600 baud, 8 data bit, 1 stop bit, even parity, no flow control.
3. DB10 has a variable of type WORD and must be passed as "Dummy".

OB1

```
L 5000
T DB73.DBW 58

CALL FB 73 , DB73
  ENABLE :=M101.0
  HARDWARE :=B#16#2
  LADDR :=
  MB_UNIT_ID :=B#16#63
  MB_DATA_PTR:=P#M 200.0 BYTE 100
  NDR :=M101.1
  DR :=M101.2
  ERROR :=M101.3
  STATUS :=MW102

UN M 101.3
SPB ERR1
L MW 102
T MW 104
ERR1: NOP 0
```



OB1 - Description

1. ➤ Calling the handling block of the Modbus/TCP server with the correct parameters.
2. ➤ If the interface was correctly initialized in the OB100, the slave can be used and MW102 returns 7006h.
3. ➤ The Modbus start register in the process image, which can be reached by *Function code 05h*, may be changed in the example by the parameter FC5_ADDR_OUTPUT_START (word 58 in the instance data block).
4. ➤ Set M101.0 in the CPU to TRUE.
⇒ The Modbus slave now works.
5. ➤ The master sends a Modbus request with *Function code 03h* start address 10 and quantity 30.
⇒ The slave responds with 60byte starting from MB200. DR is set for one CPU cycle and thus M101.2 is set to "1".
6. ➤ The master sends a Modbus request with *Function code 05h* start address 5008 and the value FF00h.
⇒ The slave acknowledges the request and writes "1" to the output Q1.0. NDR is set for one CPU cycle and thus M101.1 is set to "1".
7. ➤ The master sends a Modbus request with *Function code 03h* start address 50 (does not exist!) and quantity 1.
⇒ The server responds with *Exception code 02h* and sets ERROR/STATUS for one CPU cycle. MW104 returns 8383h.

9.3 FKT Codes

Naming convention

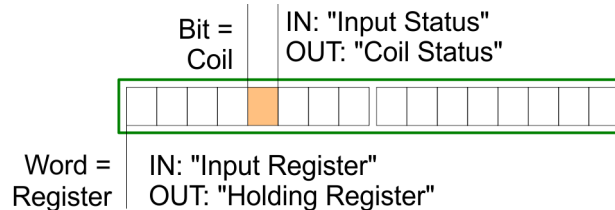
Modbus has some naming conventions:



- Modbus differentiates between bit and word access; Bits = "Coils" and Words = "Register".
- Bit inputs are referred to as "Input-Status" and bit outputs as "Coil-Status".
- Word inputs are referred to as "Input-Register" and word outputs as "Holding-Register".

Range definitions

Normally the access with Modbus happens by means of the ranges 0x, 1x, 3x and 4x.

0x and 1x gives you access to *digital* bit areas and 3x and 4x to *analog* word areas.

For the Ethernet coupler from VIPA is not differentiating digital and analog data, the following assignment is valid:

FKT Codes

- 0x - Bit area for master output
Access via function code 01h, 05h, 0Fh
- 1x - Bit area for master input
Access via function code 02h
- 3x - Word area for master input
Access via function code 04h
- 4x - Word area for master output
Access via function code 03h, 06h, 10h, 16h

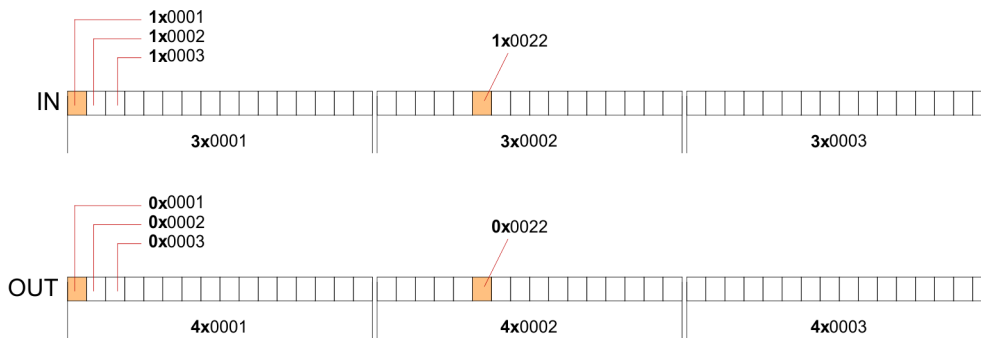

Overview

With the following Modbus function codes a Modbus master can access a Modbus slave. The description always takes place from the point of view of the master:

Code	Command	Description
01h	Read n Bits	Read n bits of master output area 0x
02h	Read n Bits	Read n bits of master input area 1x
03h	Read n Words	Read n words of master output area 4x
04h	Read n Words	Read n words master input area 3x
05h	Write 1 Bit	Write 1 bit to master output area 0x
06h	Write 1 Word	Write 1 word to master output area 4x
0Fh	Write n Bits	Write n bits to master area 0x
10h	Write n Words	Write n words to master area 4x
16h	Mask 1 Word	Mask 1 word in master output area 4x
17h	Write n Words and Read m Words	Write n words into master output area 4x and the respond contains m read words of the master input area 3x

Byte sequence in a word

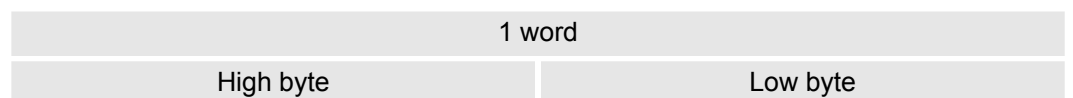

Respond of the coupler

If the slave announces an error, the function code is sent back with a "OR" and 80h. Without an error, the function code is sent back.

Coupler answer:	Function code OR 80h	→ Error & error number
	Function code	→ OK

If the slave announces an error, the function code is sent back with a "OR" and 80h. Without an error, the function code is sent back.

01h: Function number is not supported

02h: Addressing errors

03h: Data errors

04h: System SLIO bus is not initialized

07h: General error

Read n Bits 01h, 02h

Code 01h: Read n bits of master output area 0x.

Code 02h: Read n bits of master input area 1x.

Command telegram

Modbus/TCP-Header						Slave address	Function code	Address1. bit	Number of bits
x	x	0	0	0	6				
6byte						1byte	1byte	1word	1word

Respond telegram

Modbus/TCP-Header						Slave address	Function code	Number of read bytes	Data 1. byte	Data 2. byte	...
x	x	0	0	0							
6byte						1byte	1byte	1byte	1byte	1byte	
									max. 252byte		

Read n words 03h, 04h

03h: Read n words of master output area 4x.

04h: Read n words master input area 3x.

Command telegram

Modbus/TCP-Header						Slave address	Function code	Address word	Number of words
x	x	0	0	0	6				
6byte						1byte	1byte	1word	1word

Respond telegram

Modbus/TCP-Header						Slave address	Function code	Number of read bytes	Data 1. word	Data 2. word	...
x	x	0	0	0							
6byte						1byte	1byte	1byte	1word	1word	
									max. 126words		

Write 1 bit 05h

Code 05h: Write 1 bit to master output area 0x.

A status change is via "Status bit" with following values:

"Status bit" = 0000h → Bit = 0

"Status bit" = FF00h → Bit = 1

Command telegram

Modbus/TCP-Header						Slave address	Function code	Address bit	Status bit
x	x	0	0	0	6				
6byte						1byte	1byte	1word	1word

Respond telegram

Modbus/TCP-Header						Slave address	Function code	Address bit	Status bit
x	x	0	0	0	6				
6byte						1byte	1byte	1word	1word

Write 1 word 06h

Code 06h: Write 1 word to master output area 4x.

Command telegram

Modbus/TCP-Header						Slave address	Function code	Address word	Value word
x	x	0	0	0	6				
6byte						1byte	1byte	1word	1word

Respond telegram

Modbus/TCP-Header						Slave address	Function code	Address word	Value word
x	x	0	0	0	6				
6byte						1byte	1byte	1word	1word

Write n bits 0Fh

Code 0Fh: Write n bits to master output area 0x.

Please regard that the number of bits are additionally to be set in byte.

Command telegram

Modbus/TCP-Header						Slave address	Function code	Address1 . bit	Number of bits	Number of bytes	Data 1. byte	Data 2. byte	...
x	x	0	0	0									
6byte						1byte	1byte	1word	1word	1byte	1byte	1byte	1byte
											max. 248byte		

Respond telegram

Modbus/TCP-Header						Slave address	Function code	Address 1. bit	Number of bits
x	x	0	0	0	6				
6byte						1byte	1byte	1word	1word

Write n words 10h

Code 10h: Write n words to master output area 4x.

Command telegram

Modbus/TCP-Header						Slave address	Function code	Address1 . word	Number of words	Number of bytes	Data 1. word	Data 2. word	...
x	x	0	0	0									
6byte						1byte	1byte	1word	1word	1word	1word	1word	1word
											max. 124byte		

Respond telegram

Modbus/TCP-Header						Slave address	Function code	Address 1. word	Number of words
x	x	0	0	0	6				
6byte						1byte	1byte	1word	1word

Mask a word 16h

Code 16h: This function allows to mask a word in the master output area 4x.

Command telegram

Modbus/TCP-Header						Slave address	Function code	Address word	AND Mask	OR Mask
x	x	0	0	0	8					
6byte						1byte	1byte	1word	1word	1word

FKT Codes

Respond telegram

Modbus/TCP-Header						Slave address	Function code	Address word	AND Mask	OR Mask
x	x	0	0	0	8					
6byte						1byte	1byte	1word	1word	1word

10 Serial Communication

Block library "Serial Communication"

The block library can be found for download in the 'Service/Support' area of www.vipa.com at 'Downloads → VIPA Lib' as 'Block library Serial Communication - SW90GS0MA'. The library is available as packed zip file. As soon as you want to use these blocks you have to import them into your project. ↪ *Chap. 5 'Include VIPA library' page 69*

10.1 Serial communication

10.1.1 SFC 207 - SER_CTRL - Modem functionality PtP

Description



Please note that this block is not supported by SPEED7 CPUs!

The use in S7-1500 CPUs from Siemens is also not supported!

Using the RS232 interface by means of ASCII protocol the serial modem lines can be accessed with this SFC during operation. Depending on the parameter *FLOWCONTROL*, which is set by *SFC 216 (SER_CFG)*, this SFC has the following functionality:

	Read	Write
<i>FLOWCONTROL=0:</i>	DTR, RTS, DSR, RI, CTS, CD	DTR, RTS
<i>FLOWCONTROL>0:</i>	DTR, RTS, DSR, RI, CTS, CD	not possible

Parameters

Name	Declaration	Type	Description
WRITE	IN	BYTE	<ul style="list-style-type: none"> ■ Bit 0: New state DTR ■ Bit 1: New state RTS
MASKWRITE	IN	BYTE	<ul style="list-style-type: none"> ■ Bit 0: Set state DTR ■ Bit 1: Set state RTS
READ	OUT	BYTE	Status flags (CTS, DSR, RI, CD, DTR, RTS)
READDELTA	OUT	BYTE	Status flags of change between 2 accesses
RETVAL	OUT	WORD	Return value (0 = OK)

WRITE

With this parameter the status of DTR and RTS is set and activated by *MASKWRITE*. The byte has the following allocation:

- Bit 0 = DTR
- Bit 1 = RTS
- Bit 7 ... Bit 2: reserved

MASKWRITE

Here with "1" the status of the appropriate parameter is activated. The byte has the following allocation:

- Bit 0 = DTR
- Bit 1 = RTS
- Bit 7 ... Bit 2: reserved

READ You get the current status by *READ*. The current status changed since the last access is returned by *READDELTA*. The bytes have the following structure:

Bit No.	7	6	5	4	3	2	1	0
Read	x	x	RTS	DTR	CD	RI	DSR	CTS
ReadDelta	x	x	x	x	CD	RI	DSR	CTS

RETVAl (Return value)

Value	Description
0000h	no error
8x24h	Error SFC parameter x, with x: <ul style="list-style-type: none"> ■ 1: Error at <i>WRITE</i> ■ 2: Error at <i>MASKWRITE</i> ■ 3: Error at <i>READ</i> ■ 4: Error at <i>READDELTA</i>
809Ah	Interface missing
809Bh	Interface not configured (SFC 216)

10.1.2 FC/SFC 216 - SER_CFG - Parametrization PtP**Description**

Please note that this block can only be used in CPUs from VIPA or in S7-300 CPUs from Siemens!

You may de-activate the DP master integrated in the SPEED7-CPU via a hardware configuration using object properties and the parameter "Function RS485". Thus release the RS485 interface for PtP (point-to-point) communication. The RS485 interface supports in PtP operation the serial process connection to different source res. destination systems. The parametrization happens during runtime deploying the FC/SFC 216 (SER_CFG). For this you have to store the parameters in a DB for all protocols except ASCII.

Communication

- Data, which are written into the according data channel by the PLC, is stored in a FIFO send buffer (first in first out) with a size of 2x1024byte and then put out via the interface.
- When the interface receives data, this is stored in a FIFO receive buffer with a size of 2x1024byte and can there be read by the PLC.
- If the data is transferred via a protocol, the adoption of the data to the according protocol happens automatically. In opposite to ASCII and STX/ETX, the protocols 3964R, USS and Modbus require the acknowledgement of the partner.
- An additional call of the FC/SFC 217 SER_SND causes a return value in RETVAL that includes among others recent information about the acknowledgement of the partner. Further on for USS and Modbus after a SER_SND the acknowledgement telegram must be evaluated by call of the FC/SFC 218 SER_RCV.

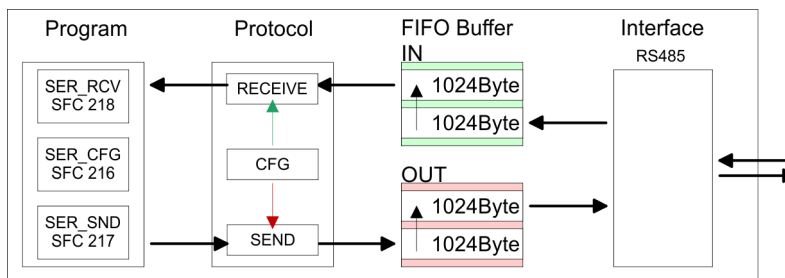

Parameters

Parameter	Declaration	Data type	Description
PROTOCOL	IN	BYTE	1=ASCII, 2=STX/ETX, 3=3964R
PARAMETER	IN	ANY	Pointer to protocol-parameters
BAUDRATE	IN	BYTE	Number of baudrate
CHARLEN	IN	BYTE	0=5bit, 1=6bit, 2=7bit, 3=8bit
PARITY	IN	BYTE	0=Non, 1=Odd, 2=Even
STOPBITS	IN	BYTE	1=1bit, 2=1.5bit, 3=2bit
FLOWCONTROL	IN	BYTE	1 - see note
RETVAL	OUT	WORD	Return value (0 = OK)

All time settings for timeouts must be set as hexadecimal value. Find the Hex value by multiply the wanted time in seconds with the baudrate.

Example:

- Wanted time 8ms at a baudrate of 19200baud
- Calculation: $19200\text{bit/s} \times 0.008\text{s} \approx 154\text{bit} \rightarrow (9Ah)$
- Hex value is 9Ah.

PROTOCOL

Here you fix the protocol to be used. You may choose between:

- 1: ASCII
- 2: STX/ETX
- 3: 3964R
- 4: USS Master
- 5: Modbus RTU Master
- 6: Modbus ASCII Master

PARAMETER (as DB)

At ASCII protocol, this parameter is ignored. At STX/ETX, 3964R, USS and Modbus you fix here a DB that contains the communication parameters and has the following structure for the according protocols:

Data block at STX/ETX			
DBB0:	STX1	BYTE	(1. Start-ID in hexadecimal)
DBB1:	STX2	BYTE	(2. Start-ID in hexadecimal)
DBB2:	ETX1	BYTE	(1. End-ID in hexadecimal)

DBB3:	ETX2	BYTE	(2. End-ID in hexadecimal)
DBW4:	TIMEOUT	WORD	(max. delay time between 2 telegrams)



The start res. end sign should always be a value <20, otherwise the sign is ignored!

With not used IDs please always enter FFh!

Data block at 3964R

DBB0:	Prio	BYTE	(The priority of both partners must be different)
DBB1:	ConnAtmptNr	BYTE	(Number of connection trials)
DBB2:	SendAtmptNr	BYTE	(Number of telegram retries)
DBB4:	CharTimeout	WORD	(Char. delay time)
DBW6:	ConfTimeout	WORD	(Acknowledgement delay time)

Data block at USS

DBW0:	Timeout	WORD	(Delay time)
-------	---------	------	--------------

Data block at Modbus master

DBW0:	Timeout	WORD	(Respond delay time)
-------	---------	------	----------------------

BAUDRATE

Velocity of data transfer in bit/s (baud)

04h:	1200baud	05h:	1800baud	06h:	2400baud	07h:	4800baud
08h:	7200baud	09h:	9600baud	0Ah:	14400baud	0Bh:	19200baud
0Ch:	38400baud	0Dh:	57600baud	0Eh:	115200baud		

CHARLEN

Number of data bits where a character is mapped to.

0: 5bit	1: 6bit	2: 7bit	3: 8bit
---------	---------	---------	---------

PARITY

The parity is -depending on the value- even or odd. For parity control, the information bits are extended with the parity bit, that amends via its value ("0" or "1") the value of all bits to a defined status. If no parity is set, the parity bit is set to "1", but not evaluated.

0: NONE	1: ODD	2: EVEN
---------	--------	---------

STOPBITS

The stop bits are set at the end of each transferred character and mark the end of a character.

1: 1bit

2: 1.5bit*

3: 2bit

*) Only permitted when *CHARLEN* = 0 (5bit)**FLOWCONTROL**

The parameter *FLOWCONTROL* is ignored. When sending RTS=1, when receiving RTS=0.

**Special function in System MICRO CPU**

From firmware version 2.4.4 with a System MICRO CPU you can switch between RS422 and RS485 communication.

0: RS422 communication

1: RS485 communication

**RETVAL FC/SFC 216
(Return values)**

Return values send by the block:

Error code	Description
0000h	no error
809Ah	Interface not found e. g. interface is used by PROFIBUS
8x24h	Error at FC/SFC-Parameter x, with x: 1: Error at <i>PROTOCOL</i> 2: Error at <i>PARAMETER</i> 3: Error at <i>BAUDRATE</i> 4: Error at <i>CHARLENGTH</i> 5: Error at <i>PARITY</i> 6: Error at <i>STOPBITS</i> 7: Error at <i>FLOWCONTROL</i>
809xh	Error in FC/SFC parameter value x, where x: 1: Error at <i>PROTOCOL</i> 3: Error at <i>BAUDRATE</i> 4: Error at <i>CHARLENGTH</i> 5: Error at <i>PARITY</i> 6: Error at <i>STOPBITS</i> 7: Error at <i>FLOWCONTROL</i> (parameter is missing)
8092h	Access error in parameter DB (DB too short)
828xh	Error in parameter x of DB parameter, where x: 1: Error 1. parameter 2: Error 2. parameter ...

10.1.3 FC/SFC 217 - SER_SND - Send to PtP

Description



Please note that this block can only be used in CPUs from VIPA or in S7-300 CPUs from Siemens!

This block sends data via the serial interface. The repeated call of the FC/SFC 217 SER_SND delivers a return value for 3964R, USS and Modbus via RETVAL that contains, among other things, recent information about the acknowledgement of the partner station. The protocols USS and Modbus require to evaluate the receipt telegram by calling the FC/SFC 218 SER_RCV after SER_SND.

Parameters

Parameter	Declaration	Data type	Description
DATAPTR	IN	ANY	Pointer to Data Buffer for sending data
DATALEN	OUT	WORD	Length of data sent
RETVAL	OUT	WORD	Return value (0 = OK)

DATAPTR

Here you define a range of the type Pointer for the send buffer where the data to be sent are stored. You have to set type, start and length.

Example:

- Data is stored in DB5 starting at 0.0 with a length of 124byte.
- DataPtr:=P#DB5.DBX0.0 BYTE 124

DATALEN

- Word where the number of the sent Bytes is stored.
- At **ASCII** if data were sent by means of FC/SFC 217 faster to the serial interface than the interface sends, the length of data to send could differ from the DATALEN due to a buffer overflow. This should be considered by the user program.
- With **STX/ETX**, **3964R**, **Modbus** and **USS** always the length set in *DATAPTR* is stored or 0.

RETVAL FC/SFC 217 (Return values)

Return values of the block:

Error code	Description
0000h	Send data - ready
1000h	Nothing sent (data length 0)
20xxh	Protocol executed error free with xx bit pattern for diagnosis
7001h	Data is stored in internal buffer - active (busy)
7002h	Transfer - active
80xxh	Protocol executed with errors with xx bit pattern for diagnosis (no acknowledgement by partner)
90xxh	Protocol not executed with xx bit pattern for diagnosis (no acknowledgement by partner)

Error code	Description
8x24h	Error in FC/SFC parameter x, where x: 1: Error in <i>DATAPTR</i> 2: Error in <i>DATALEN</i>
8122h	Error in parameter <i>DATAPTR</i> (e.g. DB too short)
807Fh	Internal error
809Ah	interface not found e.g. interface is used by PROFIBUS
809Bh	interface not configured

Protocol specific RETVAL values

ASCII

Value	Description
9000h	Buffer overflow (no data send)
9002h	Data too short (0byte)

STX/ETX

Value	Description
9000h	Buffer overflow (no data send)
9001h	Data too long (>1024byte)
9002h	Data too short (0byte)
9004h	Character not allowed

3964R

Value	Description
2000h	Send ready without error
80FFh	NAK received - error in communication
80FEh	Data transfer without acknowledgement of partner or error at acknowledgement
9000h	Buffer overflow (no data send)
9001h	Data too long (>1024byte)
9002h	Data too short (0byte)

USS

Error code	Description
2000h	Send ready without error
8080h	Receive buffer overflow (no space for receipt)
8090h	Acknowledgement delay time exceeded
80F0h	Wrong checksum in respond

Serial communication > FC/SFC 217 - SER_SND - Send to PtP

Error code	Description
80FEh	Wrong start sign in respond
80FFh	Wrong slave address in respond
9000h	Buffer overflow (no data send)
9001h	Data too long (>1024byte)
9002h	Data too short (<2byte)

Modbus RTU/ASCII Master

Error code	Description
2000h	Send ready (positive slave respond)
2001h	Send ready (negative slave respond)
8080h	Receive buffer overflow (no space for receipt)
8090h	Acknowledgement delay time exceeded
80F0h	Wrong checksum in respond
80FDh	Length of respond too long
80FEh	Wrong function code in respond
80FFh	Wrong slave address in respond
9000h	Buffer overflow (no data send)
9001h	Data too long (>1024byte)
9002h	Data too short (<2byte)

Principles of programming

The following text shortly illustrates the structure of programming a send command for the different protocols.

3964R

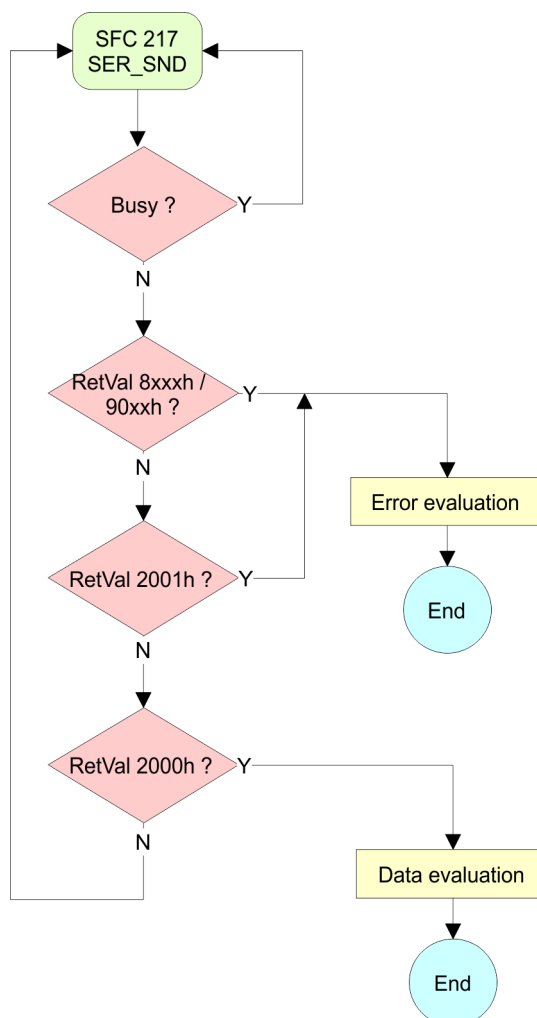

USS / Modbus

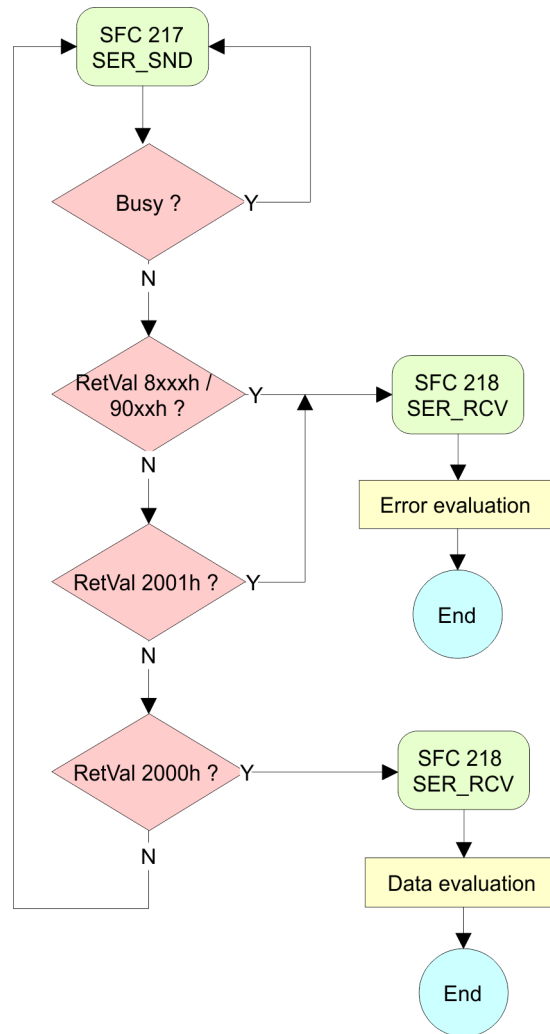

ASCII / STX/ETX

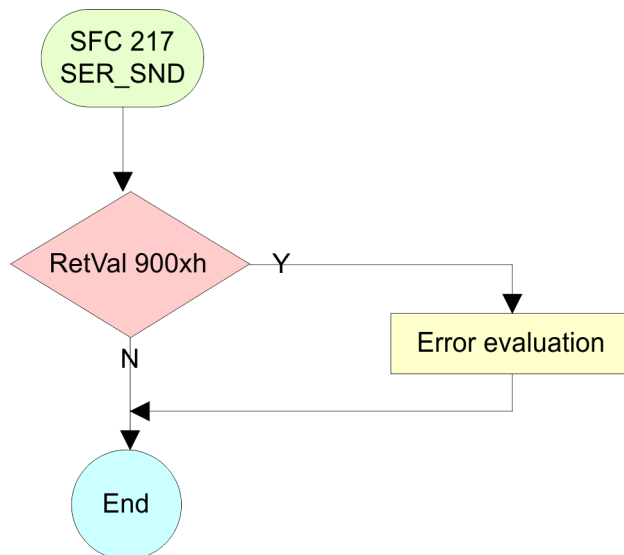

10.1.4 FC/SFC 218 - SER_RCV - Receive from PtP

Description



Please note that this block can only be used in CPUs from VIPA or in S7-300 CPUs from Siemens!

This block receives data via the serial interface. Using the FC/SFC 218 SER_RCV after SER_SND with the protocols USS and Modbus the acknowledgement telegram can be read.

Parameters

Parameter	Declaration	Data type	Description
DATAPTR	IN	ANY	Pointer to Data Buffer for received data
DATALEN	OUT	WORD	Length of received data
ERROR	OUT	WORD	Error Number
RETVAL	OUT	WORD	Return value (0 = OK)

DATAPTR

Here you set a range of the type Pointer for the receive buffer where the reception data is stored. You have to set type, start and length.

Example:

- Data is stored in DB5 starting at 0.0 with a length of 124byte.
- DataPtr:=P#DB5.DBX0.0 BYTE 124

DATALEN

- Word where the number of received Bytes is stored.
- At **STX/ETX** and **3964R**, the length of the received user data or 0 is entered.
- At **ASCII**, the number of read characters is entered. This value may be different from the read telegram length.

ERROR

This word gets an entry in case of an error. The following error messages may be created depending on the protocol:

ASCII

Bit	Error	Description
0	overrun	Overflow, a sign couldn't be read fast enough from the interface
1	framing error	Error that shows that a defined bit frame is not coincident, exceeds the allowed length or contains an additional bit sequence (Stop bit error)
2	parity	Parity error
3	overflow	Buffer is full

STX/ETX

Bit	Error	Description
0	overflow	The received telegram exceeds the size of the receive buffer.
1	char	A sign outside the range 20h ... 7Fh has been received.
3	overflow	Buffer is full.

3964R / Modbus RTU/ASCII Master

Bit	Error	Description
0	overflow	The received telegram exceeds the size of the receive buffer.

**RETVAL FC/SFC 218
(Return value)**

Error code	Description
0000h	no error
1000h	Receive buffer too small (data loss)
8x24h	Error at FC/SFC-Parameter x, with x: 1: Error at <i>DATAPTR</i> 2: Error at <i>DATALEN</i> 3: Error at <i>ERROR</i>
8122h	Error in parameter <i>DATAPTR</i> (e.g. DB too short)
809Ah	Serial interface not found res. interface is used by PROFIBUS
809Bh	Serial interface not configured

Principles of programming The following picture shows the basic structure for programming a receive command. This structure can be used for all protocols.

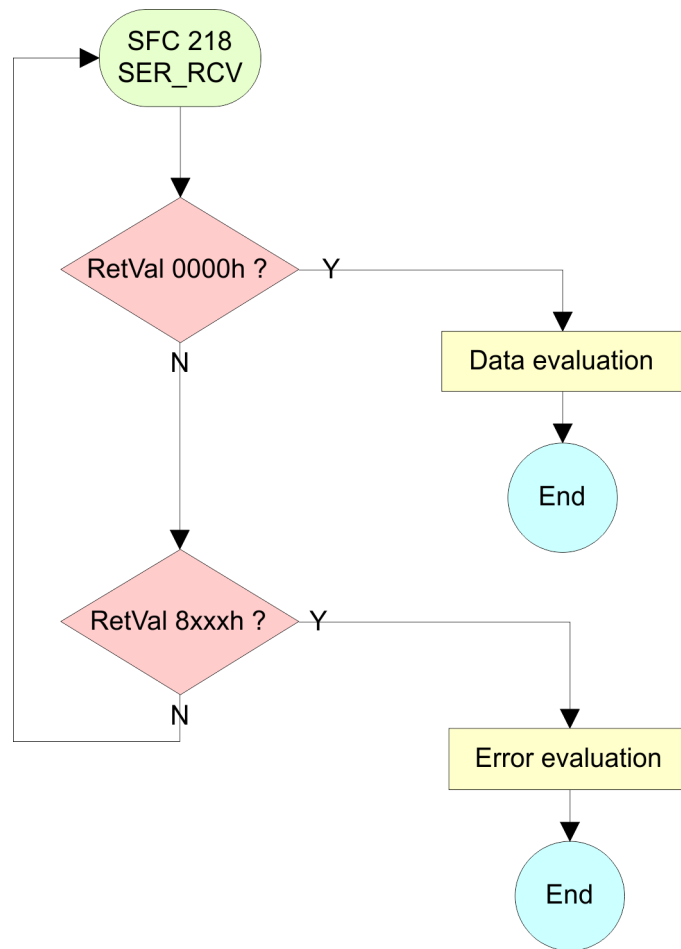

10.1.5 FB 1 - RECEIVE_ASCII - Receiving with defined length from PtP

Description



Please note that this block can only be used in CPUs from VIPA or in S7-300 CPUs from Siemens!

This FB collects the data, which are received via the internal serial interface in PtP operation and copies them into the telegram buffer specified by *EMPF_PUFFER*. If the entire telegram was received *EMPF_FERTIG* is set and the FB is left. The reading of the data may require several FB calls. The next telegram is only be read, if the bit *EMPF_FERTIG* was reset by the user. With this FB only telegrams with fix length can be received.

Parameter

Parameter	Declaration	Data type	Description
EMPF_PUFFER	IN	ANY	Pointer to DB in which the received telegram is transmitted.
ER_BYTE	OUT	WORD	Error code
EMPF_FERTIG	IN_OUT	BOOL	Status

EMPF_PUFFER

Specify here an area of type pointer, in which the received data are to be copied. Specify type, start and length.

Example:

- Data are to be stored in DB5 starting from 0.0 with length 124byte
 - DataPtr:=P#DB5.DBX0.0 BYTE 124

ER_BYTE

This word gets an entry in case of error.

Error code	Description
0003h	DB with telegram buffer does not exist.
0004h	DB with telegram buffer is too short.
7000h	Receive buffer is too small - data have been deleted!
8000h	Pointer setting in <i>EMPF_PUFFER</i> is faulty or does not exist.
9001h	DB setting in <i>EMPF_PUFFER</i> is faulty or does not exist.
9002h	Length setting in <i>EMPF_PUFFER</i> is faulty or does not exist.

10.1.6 FB 7 - P_RCV_RK - Receive from CP 341**Description**

Please note that this block can only be used in CPUs from VIPA or in S7-300 CPUs from Siemens!

The FB 7 P_RCV_RK transfers data from the CP to a data area of the CPU specified by the parameter *DB_NO*, *DBB_NO* and *LEN*. For data transfer the FB is to be called either cyclically or statically by a timer-driven program. Please note that this block calls the FC or SFC 192 CP_S_R internally. These must not be overwritten! The direct call of an internal block leads to errors in the corresponding instance DB!

Parameter

Parameter	Declaration	Data type	Description
EN_R	IN	BOOL	Enables data read
R	IN	BOOL	Aborts request - current request is aborted and receiving is blocked.
LADDR	IN	INT	Logical basic address of the CP - corresponds to the address of the hardware configuration of the CP.
DB_NO	IN	INT	Data block number - number of the receive DB, zero is not allowed.
DBB_NO	IN	INT	Data byte number - received data as of data byte $0 \leq DBB_NO \leq 8190$
L_...	OUT	-	These parameters are not relevant for ASCII and 3964(R). But they may be used by loadable protocols.
NDR*	OUT	BOOL	Request complete without errors, data received Parameter <i>STATUS</i> = 00h
ERROR*	OUT	BOOL	Request complete with error Parameter <i>STATUS</i> contains error details

Parameter	Declaration	Data type	Description
LEN*	OUT	BOOL	Length of the received telegram in byte $1 \leq LEN \leq 1024$
STATUS*	OUT	WORD	Specification of the error on $ERROR = 1$

*) Parameter is available until the next call of the FB.

Release and cancel a request

- With the signal state "1" at parameter EN_R , the software checks whether data can be read by the CP. A data transmission operation can run over several program cycles, depending on the amount of data involved.
- An active transmission can be aborted with signal state "0" at the EN_R parameter. The aborted receive request is terminated with an error message ($STATUS$).
- Receiving is deactivated as long as the EN_R parameter shows the signal state "0". A running request may be cancelled with $R = "1"$ then the FB is reset to the basic state. Receiving is deactivated as long as the R parameter shows the signal state "1".

Mechanism for startup synchronization

The FB 7 has a mechanism for startup-synchronization between CPU and CP, which is automatically executed at the first call of the FB. Before the CP can process an activated request after the CPU has changed from STOP to RUN mode, the CP CPU start-up mechanism must be completed. Any requests initiated in the meantime are transmitted once the start-up coordination with the CP is finished.



A minimum pulse time is necessary for a signal change to be identified. Significant time periods are the CPU cycle time, the updating time on the CP and the response time of the communication partner.

Error indication

- The NDR output shows "request completed without errors/data accepted". If there was an $ERROR$, the corresponding event number is displayed in the $STATUS$. If no error occurs the value of $STATUS$ is "0".
- NDR and $ERROR/STATUS$ are also output in response to a $RESET$ of the FB. In the event of an error, the binary result BR is reset. If the block is terminated without errors, the binary result has the status "1".
- Please regard the parameter NDR , $ERROR$ and $STATUS$ are only available at one block call. For further evaluation these should be copied to a free data area.

Addressing

With $LADDR$ the address of the corresponding CP is specified. This is the address, which was specified by the hardware configuration of the CP. Please regard that the base address for input and output of the CP are identical.

Data area

The FB 7 - P_RCV_RK deals with an Instance DB I_RCV_RK. This has a length from 60byte. The DB no. is transmitted with the call. It is not allowed to access the data of an instance DB.

10.1.7 FB 8 - P_SND_RK - Send to CP 341

Description



Please note that this block can only be used in CPUs from VIPA or in S7-300 CPUs from Siemens!

The FB 8 - P_SND_RK transfers a data block of a DB to the CP, specified by the parameters *DB_NO*, *DBB_NO* and *LEN*. For data transfer the FB is to be called either cyclically or statically by a timer-driven program. Please note that this block calls the FC or SFC 192 CP_S_R internally. These must not be overwritten! The direct call of an internal block leads to errors in the corresponding instance DB!

Parameter

Parameter	Declaration	Data type	Description
SF	IN	CHAR	S = Send, F = Fetch. At ASCII and 3964R the default value "S" for Send may be used
REQ	IN	BOOL	Initiates request with positive edge
R	IN	BOOL	Aborts request - current request is aborted and sending is blocked.
LADDR	IN	INT	Logical basic address of the CP - corresponds to the address of the hardware configuration of the CP.
DB_NO	IN	INT	Data block number - number of the send DB, zero is not allowed.
DBB_NO	IN	INT	Data byte number - transmitted data as of data byte $0 \leq DBB_NO \leq 8190$
LEN	IN	INT	Length of message frame to be sent in byte $1 \leq LEN \leq 1024$
R_...	IN	-	These parameters are not relevant for ASCII and 3964(R). But they may be used by loadable protocols. With Modbus enter here "X".
DONE*	OUT	BOOL	Request complete without errors, data sent Parameter <i>STATUS</i> = 00h
ERROR*	OUT	BOOL	Request complete with error Parameter <i>STATUS</i> contains error details
STATUS*	OUT	WORD	Specification of the error on <i>ERROR</i> = 1

*) Parameter is available until the next call of the FB.

Release and cancel a request

- The data transmission is initiated by a positive edge at the *REQ* input of FB 8 - P_SND_RK. A data transmission operation can run over several program cycles, depending on the amount of data involved.
- A running request may be cancelled at any time with *R* = "1" then the FB is reset to the basic state. Please regard that data, which the CP still has received from the CPU, were sent to the communication partner.
- If the *R* input is statically showing the signal state "1", this means that sending is deactivated.

Mechanism for startup synchronization

The FB 8 has a mechanism for startup-synchronization between CPU and CP, which is automatically executed at the first call of the FB. Before the CP can process an activated request after the CPU has changed from STOP to RUN mode, the CP CPU start-up mechanism must be completed. Any requests initiated in the meantime are transmitted once the start-up coordination with the CP is finished.



A minimum pulse time is necessary for a signal change to be identified. Significant time periods are the CPU cycle time, the updating time on the CP and the response time of the communication partner.

Error indication

- The *DONE* output shows "request completed without errors". If there was an *ERROR*, the corresponding event number is displayed in the *STATUS*. If no error occurs the value of *STATUS* is "0".
- *DONE* and *ERROR/STATUS* are also output in response to a *RESET* of the FB. In the event of an error, the binary result BR is reset. If the block is terminated without errors, the binary result has the status "1".
- Please regard the parameter *DONE*, *ERROR* and *STATUS* are only available at one block call. For further evaluation these should be copied to a free data area.

Addressing

With *LADDR* the address of the corresponding CP is specified. This is the address, which was specified by the hardware configuration of the CP. Please regard that the base address for input and output of the CP are identical.

Data area

The FB 8 - P_SND_RK deals with an Instance DB I_SND_RK. This has a length from 62byte. The DB no. is transmitted with the call. It is not allowed to access the data of an instance DB.

10.2 CP040

10.2.1 Overview

Communication principle

- By a cyclic call of FB 60 SEND and FB 61 RECEIVE or FB 65 CP040_COM data may be cyclically sent and received by the CP.
- On the CP the transmission of the communication protocols to the communication partner takes place, which may be configured by the hardware configuration.
- A telegram to be sent is divided into blocks in the CPU depending on the IO size and transferred via the data channel to the CP. In the CP these blocks are assembled in the send buffer, and when the telegram is complete, the telegram is sent by the serial interface.
- The exchange of received telegrams via the backplane bus is asynchronous.
- If a complete telegram was received via the serial interface, it is stored in a 1024byte ring buffer. From the length of the still free ring buffer the maximum length of a telegram results.
- Depending upon the parametrization up to 250 telegrams can be buffered, whereby their overall length may not exceed 1024.
- If the buffer is full, arriving telegrams are rejected.
- A complete telegram is divided into blocks, depending on the parametrized IO size, and transferred to the backplane bus.
- The data blocks must be assembled in the CPU.
- Since the data exchange via the backplane bus runs asynchronously, a software handshake is used between the CP and the CPU. For this, both handling blocks have the common CONTROL parameter. The same flag byte is to be used for this parameter.

CP040 > FB 60 - SEND - Send to System SLIO CP 040

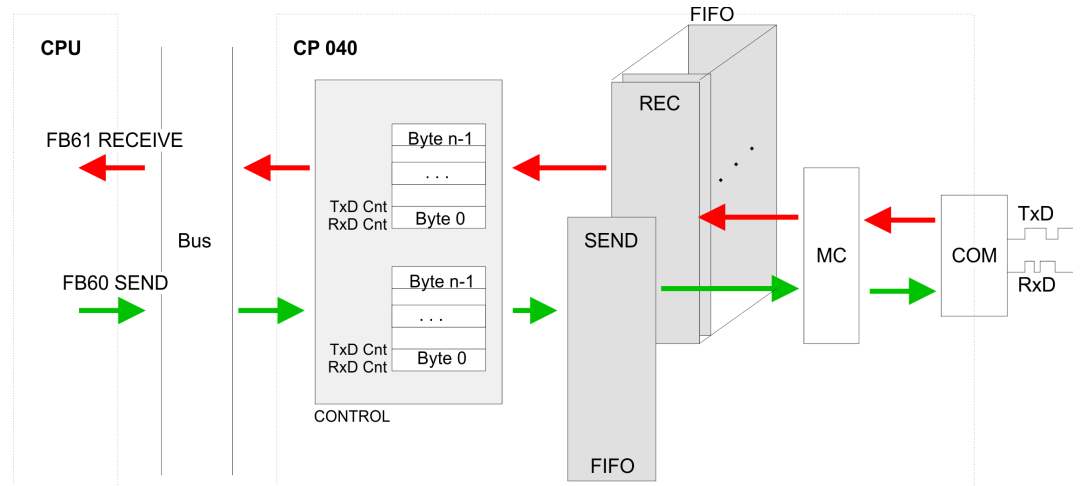

FIFO Ring buffer max. 250 telegrams 1024byte
 CONTROL Software handshake via CONTROL block

i For recognizing a signal change a minimum pulse time is necessary. The decisive factors are CPU cycle time, the refresh time on the CP and the response time of the communication partner.

10.2.2 FB 60 - SEND - Send to System SLIO CP 040

Description

This FB serves for the data output from the CPU to the System SLIO CP 040. Here you define the send range via the identifiers *DB_NO*, *DBB_NO* and *LEN*. A rising edge at *REQ* a transmission is initiated and the data is sent.

Parameters

Name	Declaration	Type	Description
REQ	IN	BOOL	Release SEND with positive edge.
R	IN	BOOL	Release synchronous reset.
LADDR / HW_ID	IN	INT / HW_IO	<ul style="list-style-type: none"> ■ LADDR <ul style="list-style-type: none"> - Logical base address of the CP. - When used in CPUs from VIPA or S7-300 CPUs from Siemens. ■ HW_ID <ul style="list-style-type: none"> - <i>HW identifier</i> to address the CP. - When used in S7-1500 CPUs from Siemens.
DB_NO	IN	INT	Number of DB containing data to send.
DBB_NO	IN	INT	Data byte number - send data starting from data byte.
LEN	IN	INT	Length of telegram in byte, to be sent.
IO_SIZE	IN	WORD	Configured IO size of the module.
DONE*	OUT	BOOL	Send order finished without errors.
ERROR*	OUT	BOOL	Send order finished with errors. Parameter <i>STATUS</i> contains the error information.
STATUS*	OUT	WORD	Specification of the error with <i>ERROR</i> = 1.

Name	Declaration	Type	Description
CONTROL	IN_OUT	BYTE	Divided byte with RECEIVE handling block: SEND (bit 0 ... 3), RECEIVE (bit 4 ... 7).
*) Parameter is available until the FB is called.			

- REQ** Request - Send release:
- With a positive edge on input *REQ* the transfer of the data is triggered.
 - Depending on the number of data, a data transfer can run over several program cycles.
- R** Synchronous reset:
- For the initialization SEND is once to be called in the start-up OB with every parameter and set *R*.
 - At any time a current order may be cancelled and the FB may be set to initial state with signal state "1" of *R*. Please regard that the data, which the CP has already received, are still sent to the communication partner.
 - The Send function is deactivated as long as *R* is statically set to "1".
- LADDR** Peripheral address:
- This parameter is only available in CPUs from VIPA or in S7-300 CPUs from Siemens.
 - With *LADDR* the address of the corresponding CP may be determined. This is the address, which you have assigned via the hardware configuration for the CP.
- HW_ID** HW identifier:
- This parameter is only available in S7-1500 CPUs of Siemens.
 - Enter at *HW_ID* the *HW identifier*, with which your module can be addressed accordingly. ↪ *Chap. 4.1 'HW identifier - HW_ID' page 66*
- DB_NO** Data block number:
- Number of the data block, which contains the data to send.
 - Zero is not permitted.
- DBB_NO** Data byte number:
- Number of data byte in the data block, starting from which the transmit data are stored.
- LEN** Length:
- Length of the user data to be sent.
 - It is: $1 \leq LEN \leq 1024$.

CP040 > FB 60 - SEND - Send to System SLIO CP 040

IO_SIZE

Size I/O area:

- Enter the size of the I/O area. Depending on the host system the CP occupies for input and output the following bytes in the I/O areas:
 - PROFIBUS: 8byte, 20byte or 60byte selectable
 - PROFINET: 20byte or 60byte selectable
 - CANopen: 8byte
 - EtherCAT: 60byte
 - DeviceNET: 60byte
 - ModbusTCP: 60byte

DONE

DONE:

- is set at order ready without errors and *STATUS* = 0000h.

ERROR

ERROR:

- is set at order ready with error. Here *STATUS* contains the corresponding error message.

STATUS

If there is no error, *STATUS* = 0000h or 8181h. With an error here the corresponding error code may be found. As long as *ERROR* is set, the value of *STATUS* is available. The following status messages are possible:

STATUS	Description
0000h	There is no error.
0202h	Possible sources of error: <ul style="list-style-type: none"> ■ Handling block and CP are not synchronous (remedy: Trigger synchronous reset) ■ <i>IO_SIZE</i> is not valid (<i>IO_SIZE</i> = 0 or <i>IO_SIZE</i> > 60).
0301h	DB is not valid.
0517h	<i>LEN</i> is not valid (<i>LEN</i> = 0 or <i>LEN</i> > 1024).
070Ah	Transfer failed, there is no response of the partner or the job was negative acknowledged.
8090h	<i>HW_ID</i> is unknown.
80A0h	When accessing the periphery, an access error was detected.
80A1h	
8181h	Job is running (status and no error message).
8323h	Send DB available, but too short.
833Ah	Send DB not readable (DB not available or DB in optimized block access). ↪ <i>Chap. 2.3 'No optimized block access' page 16</i>

CONTROL

The handling blocks SEND and RECEIVE use the common parameter *CONTROL* for the handshake. Assign to this parameter a common flag byte.

Error indication

- The *DONE* output shows "order ready without error". If there was an *ERROR*, the corresponding event number is displayed in the *STATUS*. If no error occurs the value of *STATUS* is "0".
- *DONE*, *ERROR* and *STATUS* are also output in response to a reset of the FB. In the event of an error, the binary result *BR* is reset. If the block is terminated without errors, the binary result has the status "1".
- Please regard the parameter *DONE*, *ERROR* and *STATUS* are only available at one block call. For further evaluation these should be copied to a free data area.

10.2.3 FB 61 - RECEIVE - Receive from System SLIO CP 040**Description**

This FB serves for the data reception from the System SLIO CP 040. Here you set the reception range via the identifiers *DB_NO* and *DBB_NO*. The length of the telegram is stored in *LEN*.

Parameters

Parameter	Declaration	Data type	Description
EN_R	IN	BOOL	Release RECEIVE data.
R	IN	BOOL	Release synchronous reset.
LADDR / HW_ID	IN	INT / HW_IO	<ul style="list-style-type: none"> ■ LADDR <ul style="list-style-type: none"> – Logical base address of the CP. – When used in CPUs from VIPA or S7-300 CPUs from Siemens. ■ HW_ID <ul style="list-style-type: none"> – <i>HW identifier</i> to address the CP. – When used in S7-1500 CPUs from Siemens.
DB_NO	IN	INT	Number of DB containing received data.
DBB_NO	IN	INT	Data byte number - receive data starting from data byte.
IO_SIZE	IN	WORD	Configured IO size of the module.
LEN	OUT	INT	Length of received telegram in byte
NDR*	OUT	BOOL	Receive order finished without errors.
ERROR*	OUT	BOOL	Receive order finished with errors. Parameter <i>STATUS</i> contains the error information.
STATUS*	OUT	WORD	Specification of the error with <i>ERROR</i> = 1.
CONTROL	IN_OUT	BYTE	Divided byte with RECEIVE handling block: SEND (bit 0 ... 3), RECEIVE (bit 4 ... 7).

*) Parameter is available until the FB is called.

EN_R

Enable Receive - Release to read:

- With signal status "1" at *EN_R* the examination, whether data from the CP are read, is released. Depending upon the number of data, a data transfer can run over several program cycles.
- At any time a current order may be cancelled with signal state "0" of *EN_R*. Here the cancelled receipt order is finished with an error message (*STATUS*).
- The Receive function is deactivated as long as *EN_R* is statically set to "0".

R	<p>Synchronous reset:</p> <ul style="list-style-type: none">■ For the initialization RECEIVE is once to be called in the start-up OB with every parameter and set <i>R</i>.■ At any time a current order may be cancelled and the FB may be set to initial state with signal state "1" of <i>R</i>.■ The Receive function is deactivated as long as <i>R</i> is statically set to "1".
LADDR	<p>Peripheral address:</p> <ul style="list-style-type: none">■ This parameter is only available in CPUs from VIPA or in S7-300 CPUs from Siemens.■ With <i>LADDR</i> the address of the corresponding CP may be determined. This is the address, which you have assigned via the hardware configuration for the CP.
HW_ID	<p>HW identifier:</p> <ul style="list-style-type: none">■ This parameter is only available in S7-1500 CPUs of Siemens.■ Enter at <i>HW_ID</i> the <i>HW identifier</i>, with which your module can be addressed accordingly. ↪ <i>Chap. 4.1 'HW identifier - HW_ID' page 66</i>
DB_NO	<p>Data block number:</p> <ul style="list-style-type: none">■ Number of the data block, which contains the data are read.■ Zero is not permitted.
DBB_NO	<p>Data byte number:</p> <ul style="list-style-type: none">■ Number of data byte in the data block, starting from which the received data are stored.
IO_SIZE	<p>Size I/O area:</p> <ul style="list-style-type: none">■ Enter the size of the I/O area. Depending on the host system the CP occupies for input and output the following bytes in the I/O areas:<ul style="list-style-type: none">– PROFIBUS: 8byte, 20byte or 60byte selectable– PROFINET: 20byte or 60byte selectable– CANopen: 8byte– EtherCAT: 60byte– DeviceNET: 60byte– ModbusTCP: 60byte
LEN	<p>Length:</p> <ul style="list-style-type: none">■ Length of the user data to be sent.■ It is: $1 \leq LEN \leq 1024$.
NDR	<ul style="list-style-type: none">■ New received data are ready for the CPU in the CP.
ERROR	<p>ERROR:</p> <ul style="list-style-type: none">■ is set at order ready with error. Here <i>STATUS</i> contains the corresponding error message.

STATUS

If there is no error, *STATUS* = 0000h or 8181h. With an error here the corresponding error code may be found. As long as *ERROR* is set, the value of *STATUS* is available. The following status messages are possible:

STATUS	Description
0000h	There is no error.
0202h	Possible sources of error: <ul style="list-style-type: none"> ■ Handling block and CP are not synchronous (remedy: Trigger synchronous reset) ■ <i>IO_SIZE</i> is not valid (<i>IO_SIZE</i> = 0 or <i>IO_SIZE</i> > 60).
0301h	DB is not valid.
070Ah	Transfer failed, there is no response of the partner or the job was negative acknowledged.
8090h	<i>HW_ID</i> is unknown.
80A0h	When accessing the periphery, an access error was detected.
80A1h	
8181h	Job is running (status and no error message).
8323h	Receive DB available, but too short.
833Ah	Receive DB not readable (DB not available or DB in optimized block access). ↪ <i>Chap. 2.3 'No optimized block access' page 16</i>

CONTROL

- The handling blocks SEND and RECEIVE use the common parameter *CONTROL* for the handshake.
- Assign to this parameter a common flag byte.

Error indication

- The *NDR* output shows "order ready without error / data kept". If there was an *ERROR*, the corresponding event number is displayed in the *STATUS*. If no error occurs the value of *STATUS* is "0".
- *NDR*, *ERROR* and *STATUS* are also output in response to a reset of the FB. In the event of an error, the binary result BR is reset. If the block is terminated without errors, the binary result has the status "1".
- Please regard the parameter *NDR*, *ERROR* and *STATUS* are only available at one block call. For further evaluation these should be copied to a free data area.

10.2.4 FB 65 - CP040_COM - Communication SLIO CP 040**Description**

The FB 65 serves the data in-/output from the System SLIO CPU to the CP 040. Here you define the send/receive range via the identifiers *DB_NO_SEND* and *DB_NO_RECV*. A rising edge at *REQ_SEND* a transmission is initiated and the data are sent. Via *EN_RECV* the received data are enabled.

Parameters when used in VIPA CPUs or S7-300 CPUs from Siemens

Name	Declaration	Type	Description
REQ_SEND	IN	BOOL	Release SEND with positive edge.
EN_RECV	IN	BOOL	Enable receive data.

CP040 > FB 65 - CP040_COM - Communication SLIO CP 040

Name	Declaration	Type	Description
RESET	IN	BOOL	Release synchronous reset.
ADDR_OUT	IN	INT	Logical output base address of the CP from the Hardware configuration.
ADDR_IN	IN	INT	Logical input base address of the CP from the Hardware configuration.
IO_SIZE	IN	WORD	Configured IO size of the module.
DB_NO_SEND	IN	INT	Number of DB containing data to send. Zero is not permitted.
DBB_NO_SEND	IN	INT	Data byte number - send data starting from data byte.
LEN_SEND	IN	INT	Length of telegram in byte, to be sent. $1 \leq LEN_SEND \leq 1024$
DB_NO_RECV	IN	INT	Number of DB containing data to receive. Zero is not permitted.
DBB_NO_RECV	IN	INT	Data byte number - receive data starting from data byte.
DONE_SEND*	OUT	BOOL	Send order finished without errors. Data sent: Parameter <i>STATUS_SEND</i> = 0000h.
ERROR_SEND*	OUT	BOOL	Send order finished with errors. Here Parameter <i>STATUS_SEND</i> contains the corresponding error message.
NDR_RCV*	OUT	BOOL	Receive order finished without errors. Data sent: Parameter <i>STATUS_RCV</i> = 0000h. The Parameter is available until a cycle.
ERROR_RCV*	OUT	BOOL	Receive order finished with errors. Parameter <i>STATUS_RCV</i> contains the error information.
STATUS_SEND*	OUT	WORD	Specification of the error with <i>ERROR_SEND</i> = 1
LEN_RCV	OUT	INT	Length of received telegram in byte $1 \leq LEN_RCV \leq 1024$
STATUS_RCV*	OUT	WORD	Specification of the error with <i>ERROR_RCV</i> = 1

*) Parameter is available until the FB is called.

Parameters when used in S7-1500 CPUs from Siemens

Name	Declaration	Type	Description
REQ_SEND	IN	BOOL	Release SEND with positive edge.
EN_RECV	IN	BOOL	Enable receive data.
RESET	IN	BOOL	Release synchronous reset.
HW_ID	IN	HW_IO	<i>HW identifier</i> to address the CP.
IO_SIZE	IN	WORD	Configured IO size of the module.
DB_NO_SEND	IN	INT	Number of DB containing data to send. Zero is not permitted.
DBB_NO_SEND	IN	INT	Data byte number - send data starting from data byte.

Name	Declaration	Type	Description
LEN_SEND	IN	INT	Length of telegram in byte, to be sent. $1 \leq LEN_SEND \leq 1024$
DB_NO_RECV	IN	INT	Number of DB containing data to receive. Zero is not permitted.
DBB_NO_RECV	IN	INT	Data byte number - receive data starting from data byte.
DONE_SEND*	OUT	BOOL	Send order finished without errors. Data sent: Parameter <i>STATUS_SEND</i> = 0000h.
ERROR_SEND*	OUT	BOOL	Send order finished with errors. Here Parameter <i>STATUS_SEND</i> contains the corresponding error message.
NDR_RCV*	OUT	BOOL	Receive order finished without errors. Data sent: Parameter <i>STATUS_RCV</i> = 0000h. The Parameter is available until a cycle.
ERROR_RCV*	OUT	BOOL	Receive order finished with errors. Parameter <i>STATUS_RCV</i> contains the error information.
STATUS_SEND*	OUT	WORD	Specification of the error with <i>ERROR_SEND</i> = 1
LEN_RCV	OUT	INT	Length of received telegram in byte $1 \leq LEN_RCV \leq 1024$
STATUS_RCV*	OUT	WORD	Specification of the error with <i>ERROR_RCV</i> = 1

*) Parameter is available until the FB is called.

REQ_SEND

Request - Send release:

- With a positive edge on input *REQ_SEND* the transfer of the data is triggered. Depending on the number of data, a data transfer can run over several program cycles.

EN_RECV

Enable receive data.

RESET

Synchron Reset:

- For the initialization the FB 65 is once to be called in the start-up OB with every parameter and set *RESET*.
- At any time a current order may be cancelled and the FB may be set to initial state with signal state "1" of *RESET*.
- Please regard that the data, which the CP has already received, are still sent to the communication partner. The Send function is deactivated as long as *RESET* is statically set to "1".

ADDR_IN

Peripheral input address:

- This parameter is only available in CPUs from VIPA or S7-300 CPUs from Siemens.
- With *ADDR_IN* the input address of the corresponding CP may be determined. This is the address, which you have assigned via the hardware configuration for the CP.

ADDR_OUT	Peripheral output address: <ul style="list-style-type: none">■ This parameter is only available in CPUs from VIPA or S7-300 CPUs from Siemens.■ With <i>ADDR_OUT</i> the output address of the corresponding CP may be determined. This is the address, which you have assigned via the hardware configuration for the CP.
HW_ID	HW identifier: <ul style="list-style-type: none">■ This parameter is only available in S7-1500 CPUs of Siemens.■ Enter at <i>HW_ID</i> the <i>HW identifier</i>, with which your module can be addressed accordingly. ↪ <i>Chap. 4.1 'HW identifier - HW_ID' page 66</i>
DB_NO_SEND	Number of the DB SEND: <ul style="list-style-type: none">■ Number of the data block, which contains the data to send.■ Zero is not permitted.
DBB_NO_SEND	Data byte number SEND: <ul style="list-style-type: none">■ Number of data byte in the data block, starting from which the transmit data are stored.
LEN_SEND	Length SEND: <ul style="list-style-type: none">■ Length of the user data to be sent.■ It is: $1 \leq LEN_SEND \leq 1024$.
DB_NO_RECV	Number of the DB RECV: <ul style="list-style-type: none">■ Number of the data block, which contains the receive data.■ Zero is not permitted.
DBB_NO_RECV	Data byte number RECV: <ul style="list-style-type: none">■ Number of data byte in the data block, starting from which the received data are stored.
IO_SIZE	Size I/O area: <ul style="list-style-type: none">■ Enter the size of the I/O area. Depending on the host system the CP occupies for input and output the following bytes in the I/O areas:<ul style="list-style-type: none">– SLIO CPU: 8byte, 20byte or 60byte selectable– PROFIBUS: 8byte, 20byte or 60byte selectable– PROFINET: 20byte or 60byte selectable– CANopen: 8byte– EtherCAT: 60byte– DeviceNET: 60byte– ModbusTCP: 60byte
DONE_SEND	<i>DONE_SEND</i> is set at order ready without errors and <i>STATUS_SEND</i> = 0000h.
ERROR_SEND	<i>ERROR_SEND</i> is set at order ready with error. Here <i>STATUS_SEND</i> contains the corresponding error message.

STATUS_SEND

If there is no error, *STATUS_SEND* = 0000h or 8181h. With an error here the corresponding error code may be found. As long as *ERROR_SEND* is set, the value of *STATUS_SEND* is available. Following status messages are possible:

STATUS	Description
0000h	There is no error.
0202h	<i>IO_SIZE</i> is not valid (<i>IO_SIZE</i> = 0 or <i>IO_SIZE</i> > 60).
0301h	DB is not valid.
070Ah	Transfer failed, there is no response of the partner or the job was negative acknowledged.
0517h	<i>LEN</i> is not valid (<i>LEN</i> = 0 or <i>LEN</i> > 1024).
8090h	<i>HW_ID</i> is unknown.
80A0h	When accessing the periphery, an access error was detected.
80A1h	
8181h	Job is running (status and no error message).
8323h	Send DB available, but too short.
833Ah	Send DB not readable (DB not available or DB in optimized block access. ↪ <i>Chap. 2.3 'No optimized block access' page 16</i>)

LEN_RCV

Length Receive:

- Length of the received telegram in byte.
- $1 \leq LEN_RCV \leq 1024$

NDR_RCV

New data ready:

- New received data are ready in receive DB. Signal stays for one cycle.
- Received data without error: Parameter *STATUS_RCV* = 0000h.

ERROR_RCV

ERROR_RCV is set at order ready with error. Here *STATUS_RCV* contains the corresponding error message.

STATUS_RCV

If there is no error, *STATUS_RCV* = 0000h or 8181h. With an error here the corresponding error code may be found. As long as *ERROR_RCV* is set, the value of *STATUS_RCV* is available. The following status messages are possible:

STATUS	Description
0000h	There is no error.
0202h	<i>IO_SIZE</i> is not valid (<i>IO_SIZE</i> = 0 or <i>IO_SIZE</i> > 60).
0301h	DB is not valid.
070Ah	Transfer failed, there is no response of the partner or the job was negative acknowledged.
080Ah	A free receive buffer is not available.

CP240 > FC 0 - SEND_ASCII_STX_3964 - Send to CP 240

STATUS	Description
080Ch	Wrong character received (Character frame or parity error)
8090h	<i>HW_ID</i> is unknown.
80A0h	When accessing the periphery, an access error was detected.
80A1h	
8181h	Job is running (status and no error message).
8323h	Receive DB available, but too short.
833Ah	Receive DB not readable (DB not available or DB in optimized block access). ↪ <i>Chap. 2.3 'No optimized block access' page 16</i>

Error indication

- The *DONE_SEND* output shows "send order finished without error / data kept".
- The *NDR_RCV* output shows "receive order finished without error".
- If there was *ERROR_SEND* or *ERROR_RCV*, the corresponding event number is displayed in the *STATUS_SEND*, *STATUS_RCV*. If no error occurs the value of *STATUS_SEND* and *STATUS_RCV* is 0000h.
- *DONE_SEND*, *NDR_RCV*, *ERROR_SEND*, *ERROR_RCV* and *STATUS_SEND*, *STATUS_RCV* are also output in response to a reset of the FB. In the event of an error, the binary result BR is reset. If the block is terminated without errors, the binary result has the status "1".
- Please regard the parameter *DONE_SEND*, *NDR_RCV*, *ERROR_SEND*, *ERROR_RCV* and *STATUS_SEND*, *STATUS_RCV* are only available at one block call. For further evaluation these should be copied to a free data area.

10.3 CP240**10.3.1 FC 0 - SEND_ASCII_STX_3964 - Send to CP 240****Description**

This FC serves the data output from the CPU to the CP 240. Here you define the send range via the identifiers *_DB*, *ABD* and *ANZ*. Via the bit *FRG* the send initialization is set and the data is send. After the data transfer the handling block sets the bit *FRG* back again.

Parameter

Name	Declaration	Type	Description
ADR	IN	INT	Periphery address
_DB	IN	BLOCK_DB / DB_ANY	_DB <ul style="list-style-type: none"> ■ DB number of <i>Type</i> BLOCK_DB containing data to send, used in CPUs from VIPA or in S7-300 CPUs from Siemens. ■ Pointer of <i>Typ</i> DB_ANY to the DB containing data to send, used in S7-1500 CPUs from Siemens.
ABD	IN	WORD	Number of the 1. data word.
ANZ	IN	WORD	Number of bytes.

Name	Declaration	Type	Description
PAFE	OUT / IN_OUT	BYTE	PAFE (0 = OK) <ul style="list-style-type: none"> ■ Parametrization error code of <i>Type</i> BYTE as OUT parameter, used in CPUs from VIPA or S7-300 CPUs from Siemens. ■ Parametrization error code of <i>Type</i> BYTE as IN_OUT parameter, used in S7-1500 CPUs from Siemens.
FRG	IN_OUT	BOOL	Start bit of the function.
GESE	IN_OUT	WORD	Is internally used.
ANZ_INT	IN_OUT	WORD	Is internally used.
ENDE_KOM	IN_OUT	BOOL	Is internally used.
LETZTER_BLOCK	IN_OUT	BOOL	Is internally used.
SENDEN_LAEUFT	IN_OUT	BOOL	Status of the function.
FEHLER_KOM	IN_OUT	BOOL	Is internally used.

ADR	Periphery address with which you may call the CP 240. Via the hardware configuration you may set the periphery address.
_DB	<ul style="list-style-type: none"> ■ Number of <i>Type</i> BLOCK_DB of the data block, which contains the data to send for the CP, used in CPUs from VIPA or S7-300 CPUs from Siemens. ■ Pointer of <i>Type</i> DB_ANY to the data block, which contains the data to send for the CP, used in S7-1500 CPUs from Siemens.
ABD	Word variable that contains the number of the data word from where on the characters for output are stored.
ANZ	Number of the bytes that are to be transferred.
PAFE	<p>At proper function, all bits of this bit memory byte are "0". At errors an error code is entered. The error setting is self-acknowledging, i.e. after elimination of the error cause, the byte is set back to "0" again. The following errors may occur:</p> <ul style="list-style-type: none"> ■ 1 = Data block not present ■ 2 = Data block too short ■ 3 = Data block number outside valid range
FRG enable send	At <i>FRG</i> = "1" the data defined via <i>_DB</i> , <i>ADB</i> and <i>ANZ</i> are transferred once to the CP addresses by <i>ADR</i> . After the transmission the <i>FRG</i> is set back again. When <i>FRG</i> = "0" at call of the block, it is left immediately!
GESE, ANZ_INT, ENDE_KOM, LETZTER_BLOCK, SENDEN_LAEUFT, FEHLER_KOM	These parameters are internally used. They serve the information exchange between the handling blocks. For the deployment of the SYNCHRON_RESET (FC9) the control bits <i>FRG</i> , <i>ENDE_KOM</i> , <i>LETZTER_BLOCK</i> , <i>SENDEN_LAEUFT</i> and <i>FEHLER_KOM</i> must always be stored in a bit memory byte.

CP240 > FC 1 - RECEIVE_ASCII_STX_3964 - Receive from CP 240

10.3.2 FC 1 - RECEIVE_ASCII_STX_3964 - Receive from CP 240

Description

This FC serves the data reception of the CP 240. Here you set the reception range via the identifiers *_DB* and *ABD*. When the output *EMFR* is set, a new telegram has been read completely. The length of the telegram is stored in *ANZ*. After the evaluation of the telegram this bit has to be set back by the user, otherwise no further telegram may be taken over by the CPU.

Parameter

Name	Declaration	Type	Description
ADR	IN	INT	Periphery address
_DB	IN	BLOCK_DB / DB_ANY	_DB <ul style="list-style-type: none"> ■ DB number of <i>Type</i> BLOCK_DB containing data received, used in CPUs from VIPA or in S7-300 CPUs from Siemens. ■ Pointer of <i>Type</i> DB_ANY to the DB containing data received, used in S7-1500 CPUs from Siemens.
ABD	IN	WORD	Number of the 1. data word.
ANZ	OUT / IN_OUT	WORD	ANZ <ul style="list-style-type: none"> ■ Number of received bytes of <i>Type</i> WORD as OUT parameter, used in CPUs from VIPA or in S7-300 CPUs from Siemens. ■ Number of received bytes of <i>Type</i> WORD as IN_OUT parameter, used in S7-1500 CPUs from Siemens.
PAFE	OUT / IN_OUT	BYTE	PAFE (0 = OK) <ul style="list-style-type: none"> ■ Parametrization error code of <i>Type</i> BYTE as OUT parameter, used in CPUs from VIPA or in S7-300 CPUs from Siemens. ■ Parametrization error code of <i>Type</i> BYTE as IN_OUT parameter, used in S7-1500 CPUs from Siemens.
EMFR	IN_OUT	BOOL	Acknowledgment of receipt
GEEM	IN_OUT	WORD	Is internally used.
ANZ_INT	IN_OUT	WORD	Is internally used.
EMPF_LAEUFT	IN_OUT	BOOL	Status of the function.
LETZTER_BLOCK	IN_OUT	BOOL	Is internally used.
FEHLER_EMPF	IN_OUT	BOOL	Is internally used.
OFFSET	IN_OUT	WORD	Is internally used.

ADR

Periphery address for calling the CP 240. You define the periphery address via the hardware configuration.

_DB

- DB number of *Type* BLOCK_DB containing data received from the CP, used in CPUs from VIPA or in S7-300 CPUs from Siemens.
- Pointer of *Type* DB_ANY to the data block, containing data received from the CP, used in S7-1500 CPUs from Siemens.

ABD	Word variable that contains the number of the data word from where on the received characters are stored.
ANZ	Word variable that contains the amount of received bytes.
PAFE	<p>At proper function, all bits of this bit memory byte are "0". At errors an error code is entered. The error setting is self-acknowledging, i.e. after elimination of the error cause, the byte is set back to "0" again. The following errors may occur:</p> <ul style="list-style-type: none"> ■ 1 = Data block not present ■ 2 = Data block too short ■ 3 = Data block number outside valid range
EMFR	By setting of <i>EMFR</i> the handling block shows that data has been received. Not until setting back <i>EMFR</i> in the user application new data can be received.
GEEM, ANZ_INT, LETZTER_BLOCK, EMPF_LAEUFT, FEHLER_EMPF, OFFSET	These parameters are internally used. They serve the information exchange between the handling blocks. For the deployment of the SYNCHRON_RESET (FC9) the control bits EMFR, LETZTER_BLOCK, EMPF_LAEUFT and FEHLER_EMPF must always be stored in a bit memory byte.

10.3.3 FC 8 - STEUERBIT - Modem functionality CP 240

Description This block allows you the following access to the serial modem lines:

Read: DTR, RTS, DSR, RI, CTS, CD
 Write: DTR, RTS

Parameters

Name	Declaration	Type	Comment
ADR	IN	INT	Logical Address
RTS	IN	BOOL	New state RTS
DTR	IN	BOOL	New state DTR
MASKE_RTS	IN	BOOL	<ul style="list-style-type: none"> ■ 0: do nothing ■ 1: set state RTS
MASKE_DTR	IN	BOOL	<ul style="list-style-type: none"> ■ 0: do nothing ■ 1: set state DTR
RET_VAL	OUT	WORD	Return value (0 = OK)
STATUS	OUT / IN_OUT	BYTE	<p>STATUS</p> <ul style="list-style-type: none"> ■ Status flags of <i>Type</i> BYTE as OUT parameter, used in CPUs from VIPA or in S7-300 CPUs from Siemens. ■ Status flags of <i>Type</i> BYTE as IN_OUT parameter, used in S7-1500 CPUs from Siemens.

Name	Declaration	Type	Comment
DELTA_STATUS	OUT / IN_OUT	BYTE	DELTA_STATUS <ul style="list-style-type: none"> Status flags of change between 2 accesses of <i>Type</i> BYTE as OUT parameter, used in CPUs from VIPA or in S7-300 CPUs from Siemens. Status flags of change between 2 accesses of <i>Type</i> BYTE as IN_OUT parameter, used in S7-1500 CPUs from Siemens.
START	IN_OUT	BOOL	Start bit of the function
AUFTRAG_LAEUFT	IN_OUT	BOOL	Status of function



This block must not be called as long as a transmit command is running otherwise you risk a data loss.

ADR	Periphery address with which you may call the CP 240. Via the hardware configuration you may set the periphery address.
RTS, DTR	This parameter presets the status of RTS res. <i>DTR</i> , which you may activate via <i>MASK_RTS</i> res. <i>MASK_DTR</i> .
MASK_RTS, MASK_DTR	With 1, the status of the according parameter is taken over when you set <i>START</i> to 1.
RET_VAL	At this time, this parameter always returns 00h and is reserved for future error messages.
STATUS, DELTA_STATUS	<i>STATUS</i> returns the actual status of the modem lines. <i>DELTA_STATUS</i> returns the state of the modem lines that have changed since the last access. The bytes have the following structure:

Bit no.	7	6	5	4	3	2	1	0
STATUS	x	x	RTS	DTR	CD	RI	DSR	CTS
DELTA_STATUS	x	x	x	x	CD	RI	DSR	CTS

START	By setting of <i>START</i> , the state, which has been activated via the mask, is taken over.
AUFTRAG_LAEUFT	As long as the function is executed, this bit remains set.

10.3.4 FC 9 - SYNCHRON_RESET - Synchronization CPU and CP 240

Description	The block must be called within the cyclic program section. This function is used to acknowledge the start-up ID of the CP 240 and thus the synchronization between CPU and CP. Furthermore it allows to set back the CP in case of a communication interruption to enable a synchronous start-up.
--------------------	--



A communication with *SEND* and *RECEIVE* blocks is only possible when the parameter *ANL* of the *SYNCHRON* block has been set in the start-up *OB* before.

Parameters

Name	Declaration	Type	Comment
ADR	IN	INT	Logical address
TIMER_NR	IN	TIMER	Timer
ANL	IN_OUT	BOOL	CPU restart progressed
ZERO	IN_OUT	BOOL	Internal use
RESET	IN_OUT	BOOL	Reset the CP
TIME_AN	IN_OUT	BOOL	Internal use
STEUERB_S	IN_OUT	BYTE	Internal use
STEUERB_R	IN_OUT	BYTE	Internal use

ADR	Periphery address with which you may call the CP 240. Via the hardware configuration you may set the periphery address.
TIMER_NR	Timer for the delay time.
ANL	With <i>ANL</i> = 1 the handling block is informed that a STOP/START res. NETZ-AUS/NETZ-EIN has been executed at the CPU and now a synchronization is required. After the synchronization, <i>ANL</i> is automatically set back.
ZERO	Parameter is used internally.
RESET	<i>RESET</i> = 1 allows you to set back the CP out of your user application.
TIME_AN	Parameter is used internally.
STEUERB_S	Here you have to set the bit memory byte where the control bits FRG, ENDE_KOM, LETZTER_BLOCK, SENDEN_LAEUFT and FEHLER_KOM for the SEND-FC are stored.
STEUERB_R	Here you have to set the bit memory byte where the control bits EMFR, LETZTER_BLOCK, EMPF_LAEUFT and FEHLER_EMPF for the RECEIVE-FC are stored.

10.3.5 FC 11 - ASCII_FRAGMENT - Receive fragmented from CP 240

Description



Please note that this block can only be used in CPUs from VIPA or in S7-300 CPUs from Siemens!

This FC serves the fragmented ASCII data reception. This allows you to handle on large telegrams in 12byte blocks to the CPU directly after the reception. Here the CP does not wait until the complete telegram has been received. The usage of the FC 11 presumes that you've parameterized "ASCII-fragmented" at the receiver. In the FC 11, you define the reception range via the identifiers *_DB* and *ABD*. When the output *EMFR* is set, a new telegram has been read completely. The length of the read telegram is stored in *ANZ*. After the evaluation of the telegram this bit has to be set back by the user, otherwise no further telegram may be taken over by the CPU.

Parameters

Name	Declaration	Type	Comment
ADR	IN	INT	Logical Address
_DB	IN	BLOCK_DB	DB number of DB containing data received.
ABD	IN	WORD	No. of 1st data word received
ANZ	OUT	WORD	No of bytes received
EMFR	IN_OUT	BOOL	Receipt confirmation
GEEM	IN_OUT	WORD	Internal use
ANZ_INT	IN_OUT	WORD	Internal use
EMPF_LAEUFT	IN_OUT	BOOL	Internal use
LETZTER_BLOCK	IN_OUT	BOOL	Internal use
FEHLER_EMPF	IN_OUT	BOOL	Internal use
PAFE	OUT	BYTE	Parameterization error (0 = OK)

ADR Periphery address with which you may call the CP 240. Via the hardware configuration you may set the periphery address.

_DB Number of the data block, which contains the data to be received.

ABD Word variable that contains the number of the data word from where on the received characters are stored.

ANZ Word variable that contains the amount of bytes that have been received.

EMFR By setting of *EMFR*, the handling block announces that data has been received. Only by setting back *EMFR* in the user application new data can be received.

PAFE	<p>At proper function, all bits of this bit memory byte are "0". At errors an error code is entered. The error setting is self-acknowledging, i.e. after elimination of the error cause, the byte is set back to "0" again. The following errors may occur:</p> <ul style="list-style-type: none">■ 1 = Data block not present■ 2 = Data block too short■ 3 = Data block number outside valid range
GEEM, ANZ_INT, LETZTER_BLOCK, EMPF_LAEUFT, FEHLER_EMPF	<p>These parameters are internally used. They serve the information exchange between the handling blocks. For the deployment of the SYNCHRON_RESET (FC 9) the control bits LETZTER_BLOCK, EMPF_LAEUFT and FEHLER_EMPF must always be stored in a bit memory byte.</p>

11 EtherCAT Communication

Block library "EtherCAT Communication"

The block library can be found for download in the 'Service/Support' area of www.vipa.com at 'Downloads → VIPA Lib' as 'Block library EtherCAT Communication - SW90HSOMA'. The library is available as packed zip file. As soon as you want to use these blocks you have to import them into your project. ↪ *Chap. 5 'Include VIPA library' page 69*

11.1 SDO Communication

11.1.1 FB 52 - SDO_READ - Read access to Object Dictionary Area

Description

With this block, you will have read access to the object directory of the EtherCAT slave stations and EtherCAT master. The block operates asynchronously, that is, processing covers multiple FB calls. Start the job by calling FB 52 with REQ = 1. The job status is displayed via the output parameters BUSY and RETVAL. The record set transmission is completed when the output parameter BUSY = FALSE. The error handling happens with the parameters ERROR, ERROR_ID and RETVAL.

Parameters

Parameter	Declaration	Data type	Description
REQ	IN	BOOL	REQ = 1: activates the SDO access at rising edge.
ID	IN	WORD	Logical base address of the EtherCAT slave station respectively master in the hardware configuration. With an output module bit 15 must be set (example for address 5: ID:=DW#16#8005). With a combination module you have to set the lower one of the two addresses.
INDEX	IN	WORD	Index of the object for the SDO access.
SUBINDEX	IN	BYTE	Sub index of the object for the SDO access.
COMPL_ACCESS	IN	BOOL	This parameter defines whether only a single sub-index, or the entire object is to be read.
MLEN	IN	INT	Maximum length of the data to be read.
VALID	OUT	BOOL	indicates that a new record set was received and is valid.
BUSY	OUT	BOOL	This parameter indicates the status of the SDO access. <i>BUSY = 1: SDO access is not yet terminated.</i>
ERROR	OUT	BOOL	<i>ERROR = 1: A read error has occurred.</i>
RETVAl	OUT	INT	Return value (0 = OK)
ERROR_ID	OUT	DWORD	Bus specific error code. If there was an error during the SDO access, the SDO abort error code (EtherCAT error code) can be found here.
LEN	OUT	INT	Length of the read data.
RECORD	IN_OUT	ANY	Area of the read data.



Please note that the data transferred to RECORD are not in a temporary area.

Special features at **COMPL_ACCESS (CompleteAccess)**

With the activation of the parameter **COMPL_ACCESS** the following is to be considered:

- With **COMPL_ACCESS** = true only **SUBINDEX** 0 or 1 is allowed! Otherwise you will get an error message.
- With **COMPL_ACCESS** = true for **SUBINDEX** 0 2 bytes are read, because **SUBINDEX** 1 has an offset of 2 byte.

RETVAL (return value)

In addition to the module specific error codes, which are listed here, also the general error codes for FC/SFC as return value are possible. ↪ *Chap. 4.2 'General and Specific Error Information RET_VAL' page 66*

RETVAL	Description	Error code in ERROR_ID
0x80A0	Negative acknowledgement while reading the module.	yes
0x80A1	Negative acknowledgement while writing the module.	yes
0x80A3	General protocol error.	yes
0x80A5	Internal error.	Value = 0: no Value ≠ 0: yes
0x80A7	Module is occupied (Timeout).	yes
0x80A9	Feature not supported by the module.	yes
0x80AA	Module reports a manufacturer-specific error in its application.	yes
0x80B0	Data record not known in module / Illegal data record number.	yes
0x80B4	Module reports access to an invalid area.	yes
0x80B5	Module not ready.	yes
0x80B6	Module denies access.	yes
0x80B7	Module reports an invalid range for a parameter or value.	yes
0x80B8	Module reports an invalid parameter.	yes
0x80B9	Module reports an invalid type: Buffer too small (reading subsets is not possible).	yes
0x80C2	The module currently processes the maximum possible jobs for a CPU.	yes
0x80C3	The required operating resources are currently occupied.	no
0x80C4	Internal temporary error: Job could not be carried out.	yes
0x80C5	Module not available.	yes
0x80D2	Error on reading an SDO due to wrong call parameters.	yes

ERROR_ID

On a *RETV* more information can be found in the *ERROR_ID* if available. Otherwise *ERROR_ID* is 0.

Internal error	Description
0x00000000	No error
0x98110001	Feature not supported
0x98110002	Invalid Index
0x98110003	Invalid Offset
0x98110005	Invalid Size
0x98110006	Invalid Data
0x98110007	Not ready
0x98110008	Busy
0x9811000A	No Memory left
0x9811000B	Invalid Parameter
0x9811000C	Not Found
0x9811000E	Invalid state
0x98110010	Timeout
0x98110011	Open Failed
0x98110012	Send Failed
0x98110014	Invalid Command
0x98110015	Unknown Mailbox Protocol Command
0x98110016	Access Denied
0x98110024	Slave error
0x9811002D	Ethernet link cable disconnected
0x98110031	No mailbox support

CoE Error codes	Description	CoE slave abort code
0x98110040	SDO: Toggle bit not alternated	0x05030000
0x98110041	SDO protocol timed out	0x05040000
0x98110042	SDO: Client/server command specifier not valid or unknown	0x05040001
0x98110043	SDO: Invalid block size (block mode only)	0x05040002
0x98110044	SDO: Invalid sequence number (block mode only)	0x05040003
0x98110045	SDO: CRC error (block mode only)	0x05040004
0x98110046	SDO: Out of memory	0x05040005
0x98110047	SDO: Unsupported access to an object	0x06010000
0x98110048	SDO: Attempt to read a write only object	0x06010001
0x98110049	SDO: Attempt to write a read only object	0x06010002

CoE Error codes	Description	CoE slave abort code
0x9811004A	SDO: Object does not exist in the object dictionary	0x06020000
0x9811004B	SDO: Object cannot be mapped to the PDO	0x06040041
0x9811004C	SDO: The number and length of the objects to be mapped would exceed PDO length	0x06040042
0x9811004D	SDO: General parameter incompatibility reason	0x06040043
0x9811004E	SDO: General internal incompatibility in the device	0x06040047
0x9811004F	SDO: Access failed due to an hardware error	0x06060000
0x98110050	SDO: Data type does not match, length of service parameter does not match	0x06070010
0x98110051	SDO: Data type does not match, length of service parameter too high	0x06070012
0x98110052	SDO: Data type does not match, length of service parameter too low	0x06070013
0x98110053	SDO: Sub-index does not exist	0x06090011
0x98110054	SDO: Value range of parameter exceeded (only for write access)	0x06090030
0x98110055	SDO: Value of parameter written too high	0x06090031
0x98110056	SDO: Value of parameter written too low	0x06090032
0x98110057	SDO: Maximum value is less than minimum value	0x06090036
0x98110058	SDO: General error	0x08000000
0x98110059	SDO: Data cannot be transferred or stored to the application	0x08000020
0x9811005A	SDO: Data cannot be transferred or stored to the application because of local control	0x08000021
0x9811005B	SDO: Data cannot be transferred or stored to the application because of the present device state	0x08000022
0x9811005C	SDO: Object dictionary dynamic generation fails or no object dictionary is present (e.g. object dictionary is generated from file and generation fails because of an file error)	0x08000023
0x9811005D	SDO: Unknown code	unknown
0x9811010E	Command not executed	Slave is not present at the bus

11.1.2 FB 53 - SDO_WRITE - Write access to Object Dictionary Area

Description

With this block, you will have write access to the object directory of the EtherCAT slave stations and EtherCAT master. The block operates asynchronously, that is, processing covers multiple FB calls. Start the job by calling FB 53 with REQ = 1. The job status is displayed via the output parameters BUSY and RETVAL. The record set transmission is completed when the output parameter BUSY = FALSE.

The error handling happens with the parameters ERROR, ERROR_ID and RETVAL.

Parameters

Parameter	Declaration	Data type	Description
REQ	IN	BOOL	REQ = 1: activates the SDO access at rising edge.
ID	IN	WORD	Logical base address of the EtherCAT slave station respectively master in the hardware configuration. With an output module bit 15 must be set (example for address 5: ID:=DW#16#8005). With a combination module you have to set the lower one of the two addresses.
INDEX	IN	WORD	Index of the object for the SDO access.
SUBINDEX	IN	BYTE	Sub index of the object for the SDO access.
COMPL_ACCESS	IN	BOOL	This parameter defines whether only a single sub-index, or the entire object is to be written.
LEN	IN	INT	Maximum length of the data to be written.
DONE	OUT	BOOL	indicates that a new record set was written.
BUSY	OUT	BOOL	This parameter indicates the status of the SDO access. <i>BUSY</i> = 1: SDO access is not yet terminated.
ERROR	OUT	BOOL	<i>ERROR</i> = 1: A write error has occurred.
RETVAl	OUT	INT	Return value (0 = OK)
ERROR_ID	OUT	DWORD	Bus specific error code. If there was an error during the SDO access, the SDO abort error code (EtherCAT error code) can be found here.
LEN	OUT	INT	Length of the data to be written.
RECORD	IN_OUT	ANY	Area of the data to be written.



Please note that the data transferred to RECORD are not in a temporary area.

Special features at COMPL_ACCESS (CompleteAccess)

With the activation of the parameter *COMPL_ACCESS* the following is to be considered:

- With *COMPL_ACCESS* = true only *SUBINDEX* 0 or 1 is allowed! Otherwise you will get an error message.
- With *COMPL_ACCESS* = true for *SUBINDEX* 0 2 bytes are written, because *SUBINDEX* 1 has an offset of 2 bytes.

RETVAL (return value)

In addition to the module specific error codes, which are listed here, also the general error codes for FC/SFC as return value are possible. ↪ *Chap. 4.2 'General and Specific Error Information RET_VAL' page 66*

RETVAL	Description	Error code in <i>ERROR_ID</i>
0x80A0	Negative acknowledgement while reading the module.	yes
0x80A1	Negative acknowledgement while writing the module.	yes
0x80A3	General protocol error.	yes
0x80A5	Internal error.	Value = 0: no Value ≠ 0: yes
0x80A7	Module is occupied (Timeout).	yes
0x80A9	Feature not supported by the module.	yes
0x80AA	Module reports a manufacturer-specific error in its application.	yes
0x80B0	Data record not known in module / Illegal data record number.	yes
0x80B4	Module reports access to an invalid area.	yes
0x80B5	Module not ready.	yes
0x80B6	Module denies access.	yes
0x80B7	Module reports an invalid range for a parameter or value.	yes
0x80B8	Module reports an invalid parameter.	yes
0x80B9	Module reports an invalid type: Buffer too small (writing subsets is not possible).	yes
0x80C2	The module currently processes the maximum possible jobs for a CPU.	yes
0x80C3	The required operating resources are currently occupied.	no
0x80C4	Internal temporary error: Job could not be carried out.	yes
0x80C5	Module not available.	yes
0x80D2	Error on reading an SDO due to wrong call parameters.	yes

ERROR_ID

On a *RETVAL* more information can be found in the *ERROR_ID* if available. Otherwise *ERROR_ID* is 0.

Internal error	Description
0x00000000	No error
0x98110001	Feature not supported
0x98110002	Invalid Index
0x98110003	Invalid Offset
0x98110005	Invalid Size
0x98110006	Invalid Data

SDO Communication > FB 53 - SDO_WRITE - Write access to Object Dictionary Area

Internal error	Description
0x98110007	Not ready
0x98110008	Busy
0x9811000A	No Memory left
0x9811000B	Invalid Parameter
0x9811000C	Not Found
0x9811000E	Invalid state
0x98110010	Timeout
0x98110011	Open Failed
0x98110012	Send Failed
0x98110014	Invalid Command
0x98110015	Unknown Mailbox Protocol Command
0x98110016	Access Denied
0x98110024	Slave error
0x9811002D	Ethernet link cable disconnected
0x98110031	No mailbox support

CoE Error codes	Description	CoE slave abort code
0x98110040	SDO: Toggle bit not alternated	0x05030000
0x98110041	SDO protocol timed out	0x05040000
0x98110042	SDO: Client/server command specifier not valid or unknown	0x05040001
0x98110043	SDO: Invalid block size (block mode only)	0x05040002
0x98110044	SDO: Invalid sequence number (block mode only)	0x05040003
0x98110045	SDO: CRC error (block mode only)	0x05040004
0x98110046	SDO: Out of memory	0x05040005
0x98110047	SDO: Unsupported access to an object	0x06010000
0x98110048	SDO: Attempt to read a write only object	0x06010001
0x98110049	SDO: Attempt to write a read only object	0x06010002
0x9811004A	SDO: Object does not exist in the object dictionary	0x06020000
0x9811004B	SDO: Object cannot be mapped to the PDO	0x06040041
0x9811004C	SDO: The number and length of the objects to be mapped would exceed PDO length	0x06040042
0x9811004D	SDO: General parameter incompatibility reason	0x06040043
0x9811004E	SDO: General internal incompatibility in the device	0x06040047
0x9811004F	SDO: Access failed due to an hardware error	0x06060000
0x98110050	SDO: Data type does not match, length of service parameter does not match	0x06070010
0x98110051	SDO: Data type does not match, length of service parameter too high	0x06070012

CoE Error codes	Description	CoE slave abort code
0x98110052	SDO: Data type does not match, length of service parameter too low	0x06070013
0x98110053	SDO: Sub-index does not exist	0x06090011
0x98110054	SDO: Value range of parameter exceeded (only for write access)	0x06090030
0x98110055	SDO: Value of parameter written too high	0x06090031
0x98110056	SDO: Value of parameter written too low	0x06090032
0x98110057	SDO: Maximum value is less than minimum value	0x06090036
0x98110058	SDO: General error	0x08000000
0x98110059	SDO: Data cannot be transferred or stored to the application	0x08000020
0x9811005A	SDO: Data cannot be transferred or stored to the application because of local control	0x08000021
0x9811005B	SDO: Data cannot be transferred or stored to the application because of the present device state	0x08000022
0x9811005C	SDO: Object dictionary dynamic generation fails or no object dictionary is present (e.g. object dictionary is generated from file and generation fails because of an file error)	0x08000023
0x9811005D	SDO: Unknown code	unknown
0x9811010E	Command not executed	Slave is not present at the bus

12 Device Specific

Block library "Device Specific" The block library can be found for download in the 'Service/Support' area of www.vipa.com at 'Downloads → VIPA Lib' as 'Block library Device Specific - SW90LS0MA'. The library is available as packed zip file. As soon as you want to use these blocks you have to import them into your project. ↪ *Chap. 5 'Include VIPA library' page 69*

12.1 Frequency Measurement

12.1.1 FC 300 ... 303 - Frequency measurement SLIO consistent

Overview

The following VIPA specific functions are used to control the System SLIO frequency measurement modules, which are connected via PROFIBUS, PROFINET or EtherCAT. The usage with EtherCAT is only possible at an EtherCAT CPU from VIPA. By this functions SFC 14 - DPRD_DAT respectively SFC 15 - DPWR_DAT for consistent read respectively write access to the data are internally called. Error messages of these blocks are reported by the parameter *ERROR*.

Function	Symbol	Comment
FC 300	FM_SET_CONTROL	Function to control the frequency measurement with integrated consistent access.
FC 301	FM_GET_PERIOD	Function to calculate the period duration with integrated consistent access.
FC 302	FM_GET_FREQUENCY	Function to calculate the frequency with integrated consistent access.
FC 303	FM_GET_SPEED	Function to calculate the rotational speed with integrated consistent access.

12.1.2 FC 300 - FM_SET_CONTROL - Control frequency measurement consistent

Description

The System SLIO Frequency measurement module is controlled by the FC 300 FM_SET_CONTROL. By this function the SFC 15 - DPWR_DAT for consistent write access of data is called. Here error messages of the block are reported by *ERROR*.

Parameters

Parameter	Declaration	Data type	Memory block	Description
ENABLE_FM	INPUT	BOOL	I, Q, M, D, L	Enable frequency measurement
LADDR_OUT / HW_ID	INPUT	WORD / HW_IO	I, Q, M, D, L	<ul style="list-style-type: none"> ■ LADDR_OUT <ul style="list-style-type: none"> – Logical base output address of the frequency measurement module. – When used in CPUs from VIPA or in S7-300 CPUs from Siemens. ■ HW_ID <ul style="list-style-type: none"> – <i>HW identifier</i> to address the frequency measurement module. – When used in S7-1500 CPUs from Siemens.
PRESET_CH0	INPUT	DINT	I, Q, M, D, L	Channel 0: Measurement period

Parameter	Declaration	Data type	Memory block	Description
PRESET_CH1	INPUT	DINT	I, Q, M, D, L	Channel 1: Measurement period
DONE	OUTPUT	BOOL	I, Q, M, D, L	Ready signal (TRUE = OK)
ERROR	OUTPUT	WORD	I, Q, M, D, L	Return value (0 = OK)

ENABLE_FM

With setting *ENABLE_FM* the *measuring periods*, which were preset by PRESET_CH0/1, are transferred to the channels and the measurement of both channels are started. Both frequency meters are stopped by resetting *ENABLE_FM*.



Only while *ENABLE_FM* is set, evaluated values can be retrieved from the module. Otherwise you get the error message that the channels are disabled.

LADDR_OUT

Peripheral address:

- This parameter is available in CPUs from VIPA or in S7-300 CPUs from Siemens.
- Configured base address of the output area of the System SLIO frequency measurement module, which is to be written to. The address is hexadecimal.
- (Example: Address 100: *LADDR_OUT*: = W#16#64)

HW_ID

HW identifier:

- This parameter is only available in S7-1500 CPUs of Siemens.
- Enter at *HW_ID* the *HW identifier*, with which your module can be addressed accordingly. ↪ *Chap. 4.1 'HW identifier - HW_ID' page 66*

PRESET_CHx

Enter here the measurement period in μs for the corresponding channel.

Range of values: $1\mu\text{s} \dots 8\,388\,607\mu\text{s}$

DONE

Ready signal of the function

- TRUE: Function was finished without error.
- FALSE: Function is not active respectively there is an error.

ERROR (Return value)

The following code can be reported:

Code	Description
0x0000	No error
0x80D2	Channel 0: Input value measurement period ≤ 0
0x80D3	Channel 1: Input value measurement period ≤ 0

Frequency Measurement > FC 301 - FM_GET_PERIOD - Calculate period duration consistent

Code	Description
0x80D4	Channel 0: Input value measurement period > 8 388 607µs
0x80D5	Channel 1: Input value measurement period > 8 388 607µs

Errors of the internally called SFC 15

Code	Description
0x808x	System error on the bus coupler
0x8090	<i>LADDR_OUT</i> is wrong, possible reasons: <ul style="list-style-type: none"> ■ there is no module configured on this address ■ limitation of the length of consistent data was not considered ■ Basic address in parameter <i>LADDR_OUT</i> was not entered in hexadecimal type
0x8093	There is no bus coupler existing for <i>LADDR_OUT</i> , from which consistent data can be read.
0x80A0	An access error was detected during peripheral access.
0x80B0	System error on the bus coupler
0x80B1	Specified length of the source area does not correspond to the configured user data length.
0x80B2	System error on the bus coupler
0x80B3	System error on the bus coupler
0x80C1	The data from the previous read request on the module are not processed by the module, yet.
0x80C2	System error on the bus coupler
0x80Fx	System error on the bus coupler
0x85xy	System error on the bus coupler
0x8xyy	General error information ↪ Chap. 4.2 'General and Specific Error Information RET_VAL' page 66

12.1.3 FC 301 - FM_GET_PERIOD - Calculate period duration consistent

Description

With the FC 301 FM_GET_PERIOD, you can calculate the period duration of the input signals of both channels of the System SLIO frequency measurement module. By this function internally SFC 14 - DPRD_DAT for consistent reading of user data is called. Here, the error messages of the function block are returned by *ERROR*.

Parameters

Parameter	Declaration	Data type	Memory block	Description
LADDR_IN / HW_ID	INPUT	WORD / HW_IO	I, Q, M, D, L	<ul style="list-style-type: none"> ■ LADDR_OUT <ul style="list-style-type: none"> – Logical base input address of the frequency measurement module. – When used in CPUs from VIPA or in S7-300 CPUs from Siemens. ■ HW_ID <ul style="list-style-type: none"> – <i>HW identifier</i> to address the frequency measurement module. – When used in S7-1500 CPUs from Siemens.
DONE	OUTPUT	BOOL	I, Q, M, D, L	Ready signal (TRUE = OK)
ERROR	OUTPUT	WORD	I, Q, M, D, L	Return value (0 = OK)
PERIOD_CH0	OUTPUT	DINT	I, Q, M, D, L	Channel 0: Period duration
PERIOD_CH1	OUTPUT	DINT	I, Q, M, D, L	Channel 1: Period duration

LADDR_IN

Peripheral address:

- This parameter is available in CPUs from VIPA or in S7-300 CPUs from Siemens.
- Configured base address of the input area of the System SLIO frequency measurement module, which is to be read from. The address is hexadecimal.
- (Example: Address 100: *LADDR_IN*: = W#16#64)

HW_ID

HW identifier:

- This parameter is only available in S7-1500 CPUs of Siemens.
- Enter at *HW_ID* the *HW identifier*, with which your module can be addressed accordingly. ↪ *Chap. 4.1 'HW identifier - HW_ID' page 66*

DONE

Ready signal of the function

- TRUE: Function was finished without error.
- FALSE: Function is not active respectively there is an error.

PERIOD_CHx

Currently determined period duration of the corresponding channel in 100ns.

ERROR (Return value) The following codes can be returned:

Code	Description
0x0000	No error
0x80D0	Channel 0 not in status active
0x80D1	Channel 1 not in status active
0x80DC	Channel 0: Measured time value < 0
0x80DD	Channel 1: Measured time value < 0
0x80DE	Channel 0: Measured time value > 0x7FFFFFFF
0x80DF	Channel 1: Measured time value > 0x7FFFFFFF
0x80E0	Channel 0: Determined number of edges = 0
0x80E1	Channel 1: Determined number of edges = 0
0x80E2	Channel 0: Determined number of edges < 0
0x80E3	Channel 1: Determined number of edges < 0
0x80E4	Channel 0: Determined number of edges > 0xFFFFFFFF
0x80E5	Channel 1: Determined number of edges > 0xFFFFFFFF
0x80E8	Channel 0: No valid measurement within the entered measurement period
0x80E9	Channel 1: No valid measurement within the entered measurement period

Error of the internal called SFC 14

Code	Description
0x808x	System error on the bus coupler
0x8090	<i>LADDR_IN</i> is not correct, possible reasons: <ul style="list-style-type: none"> ■ there is no module configured on this address ■ limitation of the length of consistent data was not considered ■ Basic address in parameter <i>LADDR_IN</i> was not entered in hexadecimal type
0x8093	There is no bus coupler existing for <i>LADDR_IN</i> , to which consistent data can be written.
0x80A0	An access error was detected during peripheral access.
0x80B0	System error on the bus coupler
0x80B1	Specified length of the source area does not correspond to the configured user data length.
0x80B2	System error on the bus coupler
0x80B3	System error on the bus coupler
0x80C1	The data from the previous write request on the module are not processed by the module, yet.
0x80C2	System error on the bus coupler
0x80Fx	System error on the bus coupler

Code	Description
0x85xy	System error on the bus coupler
0x8xyy	General error information ↪ Chap. 4.2 'General and Specific Error Information RET_VAL' page 66

12.1.4 FC 302 - FM_GET_FREQUENCY - Calculate frequency consistent

Description

With the FC 302 FM_GET_FREQUENCY, you can calculate the frequency of the input signals of both channels of the System SLIO frequency measurement module. By this function internally SFC 14 - DPRD_DAT for consistent reading of user data is called. Here, the error messages of the function block are returned by *ERROR*.

Parameters

Parameter	Declaration	Data type	Memory block	Description
LADDR_IN / HW_ID	INPUT	WORD / HW_IO	I, Q, M, D, L	<ul style="list-style-type: none"> ■ LADDR_IN <ul style="list-style-type: none"> – Logical base input address of the frequency measurement module. – When used in CPUs from VIPA or in S7-300 CPUs from Siemens. ■ HW_ID <ul style="list-style-type: none"> – <i>HW identifier</i> to address the frequency measurement module. – When used in S7-1500 CPUs from Siemens.
DONE	OUTPUT	BOOL	I, Q, M, D, L	Ready signal (TRUE = OK)
ERROR	OUTPUT	WORD	I, Q, M, D, L	Return value (0 = OK)
FREQUENCY_CH0	OUTPUT	DINT	I, Q, M, D, L	Channel 0: Frequency
FREQUENCY_CH1	OUTPUT	DINT	I, Q, M, D, L	Channel 1: Frequency

LADDR_IN

Peripheral address:

- This parameter is available in CPUs from VIPA or in S7-300 CPUs from Siemens.
- Configured base address of the input area of the System SLIO frequency measurement module, which is to be read from. The address is hexadecimal.
- (Example: Address 100: *LADDR_IN*: = W#16#64)

HW_ID

HW identifier:

- This parameter is only available in S7-1500 CPUs of Siemens.
- Enter at *HW_ID* the *HW identifier*, with which your module can be addressed accordingly. [↪ Chap. 4.1 'HW identifier - HW_ID' page 66](#)

DONE

Ready signal of the function

- TRUE: Function was finished without error.
- FALSE: Function is not active respectively there is an error.

Frequency Measurement > FC 302 - FM_GET_FREQUENCY - Calculate frequency consistent

FREQUENCY_CHx Currently determined frequency of the corresponding channel in mHz.

ERROR (Return value) The following codes can be returned:

Code	Description
0x0000	No error
0x80D0	Channel 0 not in status active
0x80D1	Channel 1 not in status active
0x80DA	Channel 0: Measured time value = 0
0x80DB	Channel 1: Measured time value = 0
0x80DC	Channel 0: Measured time value < 0
0x80DD	Channel 1: Measured time value < 0
0x80DE	Channel 0: Measured time value > 0x7FFFFFFF
0x80DF	Channel 1: Measured time value > 0x7FFFFFFF
0x80E2	Channel 0: Determined number of edges < 0
0x80E3	Channel 1: Determined number of edges < 0
0x80E4	Channel 0: Determined number of edges > 0xFFFFFFFF
0x80E5	Channel 1: Determined number of edges > 0xFFFFFFFF
0x80E6	Channel 0: Frequency > 600kHz
0x80E7	Channel 1: Frequency > 600kHz
0x80E8	Channel 0: No valid measurement within the entered measurement period.
0x80E9	Channel 1: No valid measurement within the entered measurement period.

Error of the internal called SFC 14

Code	Description
0x808x	System error on the bus coupler
0x8090	<i>LADDR_IN</i> is not correct, possible reasons: <ul style="list-style-type: none"> ■ there is no module configured on this address ■ limitation of the length of consistent data was not considered ■ Basic address in parameter <i>LADDR_IN</i> was not entered in hexadecimal type
0x8093	There is no bus coupler existing for <i>LADDR_IN</i> , to which consistent data can be written.
0x80A0	An access error was detected during peripheral access.
0x80B0	System error on the bus coupler
0x80B1	Specified length of the source area does not correspond to the configured user data length.
0x80B2	System error on the bus coupler
0x80B3	System error on the bus coupler

Code	Description
0x80C1	The data from the previous write request on the module are not processed by the module, yet.
0x80C2	System error on the bus coupler
0x80Fx	System error on the bus coupler
0x85xy	System error on the bus coupler
0x8xyy	General error information 🔗 Chap. 4.2 'General and Specific Error Information RET_VAL' page 66

12.1.5 FC 303 - FM_GET_SPEED - Calculate rotational speed consistent

Description

With the FC 303 FM_GET_SPEED, you can calculate the rotational speed of the input signals of both channels of the System SLIO frequency measurement module. By this function internally SFC 14 - DPRD_DAT for consistent reading of user data is called. Here, the error messages of the function block are returned by *ERROR*.

Parameters

Parameter	Declaration	Data type	Memory block	Description
LADDR_IN / HW_ID	INPUT	WORD / HW_IO	I, Q, M, D, L	<ul style="list-style-type: none"> ■ LADDR_IN <ul style="list-style-type: none"> – Logical base input address of the frequency measurement module. – When used in CPUs from VIPA or in S7-300 CPUs from Siemens. ■ HW_ID <ul style="list-style-type: none"> – <i>HW identifier</i> to address the frequency measurement module. – When used in S7-1500 CPUs from Siemens.
RESOLUTION_CH0	INPUT	DINT	I, Q, M, D, L	Channel 0: Resolution of the sensor
RESOLUTION_CH1	INPUT	DINT	I, Q, M, D, L	Channel 1: Resolution of the sensor
DONE	OUTPUT	BOOL	I, Q, M, D, L	Ready signal (TRUE = OK)
ERROR	OUTPUT	WORD	I, Q, M, D, L	return value (0 = OK)
SPEED_CH0	OUTPUT	DINT	I, Q, M, D, L	Channel 0: Rotational speed
SPEED_CH1	OUTPUT	DINT	I, Q, M, D, L	Channel 1: Rotational speed

Frequency Measurement > FC 303 - FM_GET_SPEED - Calculate rotational speed consistent

LADDR_IN

Peripheral address:

- This parameter is available in CPUs from VIPA or in S7-300 CPUs from Siemens.
- Configured base address of the input area of the System SLIO frequency measurement module, which is to be read from. The address is hexadecimal.
- (Example: Address 100: *LADDR_IN*: = W#16#64)

HW_ID

HW identifier:

- This parameter is only available in S7-1500 CPUs of Siemens.
- Enter at *HW_ID* the *HW identifier*, with which your module can be addressed accordingly. ↪ *Chap. 4.1 'HW identifier - HW_ID' page 66*

RESOLUTION_CHx

Enter here the resolution in increments per revolution for the corresponding channel .

DONE

Ready signal of the function

- TRUE: Function was finished without error.
- FALSE: Function is not active respectively there is an error.

SPEED_CHx

Currently determined rotational speed of the corresponding channel in revolutions per minute (rpm).

ERROR (Return value)

The following codes can be returned:

Code	Description
0x0000	No error
0x80D0	Channel 0 not in status active
0x80D1	Channel 1 not in status active
0x80D6	Channel 0: Input value RESOLUTION_CH0 = 0
0x80D7	Channel 1: Input value RESOLUTION_CH1 = 0
0x80D8	Channel 0: Input value RESOLUTION_CH0 < 0
0x80D9	Channel 1: Input value RESOLUTION_CH1 < 0
0x80DA	Channel 0: Measured time value = 0
0x80DB	Channel 1: Measured time value = 0
0x80DC	Channel 0: Measured time value < 0
0x80DD	Channel 1: Measured time value < 0
0x80DE	Channel 0: Measured time value > 0x7FFFFFFF
0x80DF	Channel 1: Measured time value > 0x7FFFFFFF
0x80E2	Channel 0: Determined number of edges < 0
0x80E3	Channel 1: Determined number of edges < 0
0x80E4	Channel 0: Determined number of edges > 0xFFFFFFFF
0x80E5	Channel 1: Determined number of edges > 0xFFFFFFFF
0x80E6	Channel 0: Determined rotational speed > max. (DINT)
0x80E7	Channel 1: Determined rotational speed > max. (DINT)
0x80E8	Channel 0: No valid measurement within the entered measurement period
0x80E9	Channel 1: No valid measurement within the entered measurement period

Error of the internal called SFC 14

Code	Description
0x808x	System error on the bus coupler
0x8090	<i>LADDR_IN</i> is not correct, possible reasons: <ul style="list-style-type: none"> ■ there is no module configured on this address ■ limitation of the length of consistent data was not considered ■ Basic address in parameter <i>LADDR_IN</i> was not entered in hexadecimal type
0x8093	There is no bus coupler existing for <i>LADDR_IN</i> , to which consistent data can be written.
0x80A0	An access error was detected during peripheral access.
0x80B0	System error on the bus coupler
0x80B1	Specified length of the source area does not correspond to the configured user data length.

Code	Description
0x80B2	System error on the bus coupler
0x80B3	System error on the bus coupler
0x80C1	The data from the previous write request on the module are not processed by the module, yet.
0x80C2	System error on the bus coupler
0x80Fx	System error on the bus coupler
0x85xy	System error on the bus coupler
0x8xyy	General error information ↳ Chap. 4.2 'General and Specific Error Information RET_VAL' page 66

12.1.6 FC 310 ... 313 - Frequency measurement SLIO

Overview

The following VIPA specific functions are used to control the System SLIO frequency measurement modules, if the consistency of the data are ensured by the bus protocol and consistent reading respectively writing with SFC 14 respectively SFC 15 is not possible. Within the functions there are "FM_..." parameters, whose content is to be consistently connected to the corresponding input or output area of the frequency measurement module by means of the bus system. By calling the appropriate function the corresponding "FM_..." parameters are automatically filled by the function.

Function	Symbol	Comment
FC 310	FM_CONTROL	Function to control the frequency measurement
FC 311	FM_CALC_PERIOD	Function to calculate the period duration
FC 312	FM_CALC_FREQUENCY	Function to calculate the frequency
FC 313	FM_CALC_SPEED	Function to calculate the rotational speed

12.1.7 FC 310 - FM_CONTROL - Control frequency measurement

Description

The System SLIO Frequency measurement module is controlled by the FC 310 FM_CONTROL. Since this FC does not internally call a block for consistent write access of data, you have to ensure consistent data transfer in your system.

Parameters

Parameter	Declaration	Data type	Memory block	Description
ENABLE_FM	INPUT	BOOL	I, Q, M, D, L	Enable frequency measurement
PRESET_CH0	INPUT	DINT	I, Q, M, D, L	Channel 0: Measurement period

Parameter	Declaration	Data type	Memory block	Description
PRESET_CH1	INPUT	DINT	I, Q, M, D, L	Channel 1: Measurement period
DONE	OUTPUT	BOOL	I, Q, M, D, L	Ready signal (TRUE = OK)
ERROR	OUTPUT	WORD	I, Q, M, D, L	return value (0 = OK)
FM_PRESET_PERIOD_CH0	OUTPUT	DWORD	I, Q, M, D, L	Setpoint value for frequency measurement module output address: +0
FM_PRESET_PERIOD_CH1	OUTPUT	DWORD	I, Q, M, D, L	Setpoint value for frequency measurement module output address: +4
FM_CONTROL_CH0	OUTPUT	WORD	I, Q, M, D, L	Setpoint value for frequency measurement module output address: +8
FM_CONTROL_CH1	OUTPUT	WORD	I, Q, M, D, L	Setpoint value for frequency measurement module output address: +10

ENABLE_FM

With setting *ENABLE_FM* the corresponding CONTROL is generated and issued via *FM_CONTROL_CHx*. The measurement of both channels is started as soon as the content of *FM_CONTROL_CHx* was consistent transferred by the bus system to the frequency measurement module. The measurement of both channels is stopped by resetting *ENABLE_FM*, after *FM_CONTROL_CHx* was consistent transferred to the frequency measurement module.



Only as long as the frequency meters are started, evaluated values can be retrieved from the module. Otherwise you get the error message that the channels are disabled.

PRESET_CHx

Enter here the measurement period in μs for the corresponding channel.

Range of values: $1\mu\text{s}$... 8 388 607 μs

DONE

Ready signal of the function

- TRUE: Function was finished without error.
- FALSE: Function is not active respectively there is an error.

FM_PRESET_PERIOD_CHx

This parameter contains the measuring period for channel 0 respectively channel 1. The content is to be consistent connected with address +0 respectively +4 of the output area of the frequency measurement module, via the according bus system.

FM_CONTROL_CHx This parameter contains CONTROL, which is generated by *ENABLE_FM*. The content for channel 0 respectively channel 1 is to be consistent connected with address +8 respectively +10 of the output area of the frequency measurement module, via the according bus system.

ERROR (Return value) The following code can be reported:

Code	Description
0x0000	No error
0x80D2	Channel 0: Input value measurement period ≤ 0
0x80D3	Channel 1: Input value measurement period ≤ 0
0x80D4	Channel 0: Input value measurement period $> 8\,388\,607\mu\text{s}$
0x80D5	Channel 1: Input value measurement period $> 8\,388\,607\mu\text{s}$

12.1.8 FC 311 - FM_CALC_PERIOD - Calculate period duration

Description With the FC 311 FM_CALC_PERIOD, you can calculate the period duration of the input signals of both channels. Since this FC does not internally call a block for consistent read access of data, you have to ensure consistent data transfer in your system.

Parameters

Parameter	Declaration	Data type	Memory block	Description
FM_PERIOD_CH0	INPUT	DWORD	I, Q, M, D, L	Actual value of frequency measurement module input address: +0
FM_PERIOD_CH1	INPUT	DWORD	I, Q, M, D, L	Actual value of frequency measurement module input address: +8
FM_RISING_EDGES_CH0	INPUT	DWORD	I, Q, M, D, L	Actual value of frequency measurement module input address: +4
FM_RISING_EDGES_CH1	INPUT	DWORD	I, Q, M, D, L	Actual value of frequency measurement module input address: +12
FM_STATUS_CH0	INPUT	WORD	I, Q, M, D, L	Actual value of frequency measurement module input address: +16

Parameter	Declaration	Data type	Memory block	Description
FM_STATUS_CH1	INPUT	WORD	I, Q, M, D, L	Actual value of frequency measurement module input address: +18
DONE	OUTPUT	BOOL	I, Q, M, D, L	Ready signal (TRUE = OK)
ERROR	OUTPUT	WORD	I, Q, M, D, L	Return value (0 = OK)
PERIOD_CH0	OUTPUT	DINT	I, Q, M, D, L	Channel 0: Period duration
PERIOD_CH1	OUTPUT	DINT	I, Q, M, D, L	Channel 1: Period duration

FM_PERIOD_CHx This parameter contains the measured time value of channel 0 respectively channel 1. The content is to be consistent connected with address +0 respectively +4 of the input area of the frequency measurement module, via the according bus system.

FM_RISING_EDGES_CHx This parameter contains the determined number of rising edges for channel 0 respectively channel 1. The content is to be consistent connected with address +8 respectively +12 of the input area of the frequency measurement module, via the according bus system.

FM_STATUS_CHx This parameter contains the status of channel 0 respectively channel 1. The content is to be consistent connected with address +16 respectively +18 of the input area of the frequency measurement module, via the according bus system.

DONE Ready signal of the function

- TRUE: Function was finished without error.
- FALSE: Function is not active respectively there is an error.

PERIOD_CHx Currently determined period duration of the corresponding channel in 100ns.

ERROR (Return value) The following codes can be returned:

Code	Description
0x0000	No error
0x80D0	Channel 0 not in status active
0x80D1	Channel 1 not in status active
0x80DC	Channel 0: Measured time value < 0
0x80DD	Channel 1: Measured time value < 0
0x80DE	Channel 0: Measured time value > 0x7FFFFFFF
0x80DF	Channel 1: Measured time value > 0x7FFFFFFF
0x80E0	Channel 0: Determined number of edges = 0
0x80E1	Channel 1: Determined number of edges = 0
0x80E2	Channel 0: Determined number of edges < 0
0x80E3	Channel 1: Determined number of edges < 0
0x80E4	Channel 0: Determined number of edges > 0xFFFFFFFF
0x80E5	Channel 1: Determined number of edges > 0xFFFFFFFF
0x80E8	Channel 0: No valid measurement within the entered measurement period
0x80E9	Channel 1: No valid measurement within the entered measurement period

12.1.9 FC 312 - FM_CALC_FREQUENCY - Calculate frequency

Description

With the FC 312 FM_CALC_FREQUENCY, you can calculate the period duration of the input signals of both channels. Since this FC does not internally call a block for consistent read access of data, you have to ensure consistent data transfer in your system.

Parameters

Parameter	Declaration	Data type	Memory block	Description
FM_PERIOD_CH0	INPUT	DWORD	I, Q, M, D, L	Actual value of frequency measurement module input address: +0
FM_PERIOD_CH1	INPUT	DWORD	I, Q, M, D, L	Actual value of frequency measurement module input address: +8
FM_RISING_EDGES_CH0	INPUT	DWORD	I, Q, M, D, L	Actual value of frequency measurement module input address: +4
FM_RISING_EDGES_CH1	INPUT	DWORD	I, Q, M, D, L	Actual value of frequency measurement module input address: +12

Parameter	Declaration	Data type	Memory block	Description
FM_STATUS_CH0	INPUT	WORD	I, Q, M, D, L	Actual value of frequency measurement module input address: +16
FM_STATUS_CH1	INPUT	WORD	I, Q, M, D, L	Actual value of frequency measurement module input address: +18
DONE	OUTPUT	BOOL	I, Q, M, D, L	Ready signal (TRUE = OK)
ERROR	OUTPUT	WORD	I, Q, M, D, L	Return value (0 = OK)
FREQUENCY_CH0	OUTPUT	DINT	I, Q, M, D, L	Channel 0: Calculated frequency
FREQUENCY_CH1	OUTPUT	DINT	I, Q, M, D, L	Channel 1: Calculated frequency

FM_PERIOD_CHx This parameter contains the measured time value of channel 0 respectively channel 1. The content is to be consistent connected with address +0 respectively +4 of the input area of the frequency measurement module, via the according bus system.

FM_RISING_EDGES_CHx This parameter contains the determined number of rising edges for channel 0 respectively channel 1. The content is to be consistent connected with address +8 respectively +12 of the input area of the frequency measurement module, via the according bus system.

FM_STATUS_CHx This parameter contains the status of channel 0 respectively channel 1. The content is to be consistent connected with address +16 respectively +18 of the input area of the frequency measurement module, via the according bus system.

DONE Ready signal of the function

- TRUE: Function was finished without error.
- FALSE: Function is not active respectively there is an error.

FREQUENCY_CHx Currently determined frequency of the corresponding channel in mHz.

ERROR (Return value) The following codes can be returned:

Code	Description
0x0000	No error
0x80D0	Channel 0 not in status active
0x80D1	Channel 1 not in status active
0x80DA	Channel 0: Measured time value = 0

Code	Description
0x80DB	Channel 1: Measured time value = 0
0x80DC	Channel 0: Measured time value < 0
0x80DD	Channel 1: Measured time value < 0
0x80DE	Channel 0: Measured time value > 0x7FFFFFFF
0x80DF	Channel 1: Measured time value > 0x7FFFFFFF
0x80E2	Channel 0: Determined number of edges < 0
0x80E3	Channel 1: Determined number of edges < 0
0x80E4	Channel 0: Determined number of edges > 0xFFFFFFFF
0x80E5	Channel 1: Determined number of edges > 0xFFFFFFFF
0x80E6	Channel 0: Frequency > 600kHz
0x80E7	Channel 1: Frequency > 600kHz
0x80E8	Channel 0: No valid measurement within the entered measurement period.
0x80E9	Channel 1: No valid measurement within the entered measurement period.

12.1.10 FC 313 - FM_CALC_SPEED - Calculate rotational speed

Description

With the FC 313 FM_CALC_SPEED, you can calculate the velocity of the input signals of both channels. Since this FC does not internally call a block for consistent read access of data, you have to ensure consistent data transfer in your system.

Parameters

Parameter	Declaration	Data type	Memory block	Description
FM_PERIOD_CH0	INPUT	DWORD	I, Q, M, D, L	Actual value of frequency measurement module input address: +0
FM_PERIOD_CH1	INPUT	DWORD	I, Q, M, D, L	Actual value of frequency measurement module input address: +8
FM_RISING_EDGES_CH0	INPUT	DWORD	I, Q, M, D, L	Actual value of frequency measurement module input address: +4
FM_RISING_EDGES_CH1	INPUT	DWORD	I, Q, M, D, L	Actual value of frequency measurement module input address: +12
FM_STATUS_CH0	INPUT	WORD	I, Q, M, D, L	Actual value of frequency measurement module input address: +16
FM_STATUS_CH1	INPUT	WORD	I, Q, M, D, L	Actual value of frequency measurement module input address: +18

Parameter	Declaration	Data type	Memory block	Description
RESOLUTION_CH0	INPUT	DINT	I, Q, M, D, L	Channel 0: Resolution of the sensor
RESOLUTION_CH1	INPUT	DINT	I, Q, M, D, L	Channel 1: Resolution of the sensor
DONE	OUTPUT	BOOL	I, Q, M, D, L	Ready signal (TRUE = OK)
ERROR	OUTPUT	WORD	I, Q, M, D, L	Return value (0 = OK)
SPEED_CH0	OUTPUT	DINT	I, Q, M, D, L	Channel 0: Calculated rotational speed
SPEED_CH1	OUTPUT	DINT	I, Q, M, D, L	Channel 1: Calculated rotational speed

- FM_PERIOD_CHx** This parameter contains the measured time value for channel 0 respectively channel 1. The content is to be consistent connected with address +0 respectively +4 of the input area of the frequency measurement module, via the according bus system.
- FM_RISING_EDGES_CHx** This parameter contains the determined number of rising edges for channel 0 respectively channel 1. The content is to be consistent connected with address +8 respectively +12 of the input area of the frequency measurement module, via the according bus system.
- FM_STATUS_CHx** This parameter contains the status of channel 0 respectively channel 1. The content is to be consistent connected with address +16 respectively +18 of the input area of the frequency measurement module, via the according bus system.
- RESOLUTION_CHx** Enter here the resolution in increments per revolution for the corresponding channel.
- DONE** Ready signal of the function
- TRUE: Function was finished without error.
 - FALSE: Function is not active respectively there is an error.
- SPEED_CHx** Currently determined rotational speed of the corresponding channel in revolutions per minute (rpm).

ERROR (Return value) The following codes can be returned:

Code	Description
0x0000	No error
0x80D0	Channel 0 not in status active
0x80D1	Channel 1 not in status active
0x80D6	Channel 0: Input value RESOLUTION_CH0 = 0
0x80D7	Channel 1: Input value RESOLUTION_CH1 = 0
0x80D8	Channel 0: Input value RESOLUTION_CH0 < 0
0x80D9	Channel 1: Input value RESOLUTION_CH1 < 0
0x80DA	Channel 0: Measured time value = 0
0x80DB	Channel 1: Measured time value = 0
0x80DC	Channel 0: Measured time value < 0
0x80DD	Channel 1: Measured time value < 0
0x80DE	Channel 0: Measured time value > 0x7FFFFFFF
0x80DF	Channel 1: Measured time value > 0x7FFFFFFF
0x80E2	Channel 0: Determined number of edges < 0
0x80E3	Channel 1: Determined number of edges < 0
0x80E4	Channel 0: Determined number of edges > 0xFFFFFFFF
0x80E5	Channel 1: Determined number of edges > 0xFFFFFFFF
0x80E6	Channel 0: Determined rotational speed > max. (DINT)
0x80E7	Channel 1: Determined rotational speed > max. (DINT)
0x80E8	Channel 0: No valid measurement within the entered measurement period
0x80E9	Channel 1: No valid measurement within the entered measurement period

12.2 Energy Measurement

12.2.1 Overview

12.2.1.1 Terms

Measurand

A *measurand* is a physical quantity that can be measured such as current, voltage or temperature.

Measured value

A *measured value* is a value of a measurand, which is determined by measurement or by calculation.

ID

In the module each *measurand* one *ID* is assigned. The access to the measured value of a measurand happens by means of the corresponding *ID*.

- DS-ID**
- As soon as the module is supplied by the DC 24V power section supply, the measurement is started and the counting of the energy counters is continued with the retentive stored counter values. The measured values of all the measurands are stored in the module with one record set ID *DS-ID*. The following must be observed:
- All measured values with the same *DS-ID* come from the same measurement and are consistent.
 - By specifying the *DS-ID* you can address the individual measured values of the same measurement.
 - The *DS-ID* covers the values 1 ... 15.
 - To refresh the measured values the *DS-ID* is to be incremented by 1. The value 15 must be followed by 1.
 - If the *DS-ID* is incremented and there is still no new value available, the current value is returned. Here the energy measurement module reports an error.
 - *DS-ID* = 0 - Auto increment mode
 - With *DS-ID* = 0 there is a request with *auto increment mode*. Here the module always returns the current measured value. As soon as a new measured value is available, here the *DS-ID* is incremented by one within the values 1 ... 15. If there is no new measured value available, the *DS-ID* is not changed. Here the energy measurement module reports an error.
 - The uniqueness of a measured value always consists of the *ID* of the measurand and the *DS-ID*.

- Frame**
- In the module you can combine some measurands to one data package (Frame), which is transferred in one step. One data package consists of 12byte user data. Considering the data length of 12 bytes, you can define the content of a frame by specifying the *ID* of the measurands. Up to 256 frames may be configured (*Frame 0 ... Frame 255*). The following must be observed:
- The definition of *Frame 1* to *Frame 255* happens by the command *Set_Frame*.
 - *Frame 0* with the corresponding measurands can exclusively be specified by the parametrization.
 - With telegram type *Zero Frame* the data package of *Frame 0* can be accessed. After the start-up of the module there are automatic *Zero Frame* requests as long as the process data communication comes from the head module.

- FR-ID**
- When defining frames by means of '*Set Frame*', via the *FR-ID* these are assigned to a number between 0 ... 255. By specifying the *FR-ID* you can request the corresponding frame.

- Data type**
- In the following the data types are listed, which are used in the module. The length is to be considered particularly by the definition of *Frames*.

Data type	Length in byte	Description
UINT_8	1	Integer 8bit
UINT_16	2	Integer 16bit
UINT_32	4	Integer 32bit
INT_8	1	Signed integer 8bit
INT_16	2	Signed integer 16bit
INT_32	4	Signed integer 32bit
FLOAT	4	32bit floating point IEEE 754

12.2.1.2 Functionality

Overview

- The energy measuring module is used to measure the energy of a 3-phase connection. In addition to voltage, current and phase, the module determines many other measurands.
- Limit values can be parametrized for some measurands. When exceeding or falling below corresponding interrupt status bits are set. The module supports several commands (CMD). For example, interrupt status bits can be reset hereby.
- With the function block FB 325 and the associated data structure of type UDT 325, you can read energy measured values and interrupt status bits of the energy measurement module and commands can be executed on the module. In this case, the FB 325 communicates via the cyclic I/O data (16 bytes each) of the module, which must be specified accordingly when FB 325 is called.
- The real request interface is realized via the data structure of the type UDT 325. This makes simple control and evaluation possible, for example via a touch panel.

Interconnection of the FB 325:

- During the configuration, make sure that the parameters CHANNEL_IN and CHANNEL_OUT of the FB 325 are correctly interconnected. Otherwise, you will receive a timeout error message.
 - CHANNEL_IN is to be interconnected to the 16byte input data of the energy measurement module.
 - CHANNEL_OUT is to be interconnected to the 16byte output data of the energy measurement module.

Cyclic measured value acquisition

- By performing a manual reset after PowerON, you can avoid temporary error messages. To do this, you have to set bit 7 of the variable *Header.Control_Global* in the data structure *MEAS_DATA* of FB 325.
- With the basic settings of the UDT 325, all measured values of the energy measuring module are read with a period of 1s and stored in the data structure *MEAS_DATA*. You can adjust the period via the variable *Header.Polltime* in the data structure *MEAS_DATA* of the FB 325.



To validate the relevancy of your measured values, you can check the DS-ID parameter for the time of its last change. As soon as a new measured value is available, the DS-ID is incremented by 1 within the values 1 ... 15. The time of the last change is at the same time the age of the last measured values.

Manual measured value acquisition

For the manual measured value acquisition you have to set bit 1 of the variable *Header.Control_Global* in the data structure *MEAS_DATA* of the FB 325. If the bit is set, the measured values are read once by the energy measurement module and then the bit is reset.

Selection of the measurands

By default, the measured values of all *measurands* are read periodically. However, you have the option of selecting the *measurands* in the data structure *MEAS_DATA*. Via bit 0 of the variable *Data.[Name of the measurand].Read_Mode* the access to the value of the corresponding *measurand* can be set. Please note that here the measurand IDs are grouped together. As soon as at least one measured value of a *measurand* of a group is to be read, the measured values of all *measurands* of this group are read. For example, if the value of the measurand with the ID no. 4 is to be read, so are those with ID no. 5 and 6 are read. There are the following groupings:

Group	IDs of the measurands	Group	IDs of the measurands	Group	IDs of the measurands
1	1, 2, 3	6	16, 17, 18	11	31, 32, 33
2	4, 5, 6	7	19, 20, 21	12	34, 35, 36
3	7, 8, 9	8	22, 23, 24	13	37, 38, 39
4	10, 11, 12	9	25, 26, 27	14	40, 41
5	13, 14, 15	10	28, 29, 30		

The measured values read are entered in the corresponding variables of *Data.[Name of the measurand].Value*. For unread measured values *Value* = 0.

Command Interface

You can trigger commands via the data structure *MEAS_DATA* by setting the corresponding bits in the variable *Header.Cmd*. If several bits are set, they are sequentially processed. Here, the following commands are available:

- Bit 0: Reset all the energy counters
- Bit 1: Trigger reset on the current transformer
- Bit 2: Reset *status measurement*
- Bit 3: Writing the energy setpoints from "SetValues" to the ID3 ... ID8.

Error behavior

- Error messages that occur during the initialization of the block or when reading measured values can be found in the data structure *MEAS_DATA* at *Header.Status_Global*.
- Error messages that occur during command processing can be found at *Header.Status_Cmd* and the detailed information at *Header.Error_ID*
- In the event of an error, the function block continues the order processing. Here, the faulty jobs are repeated. The measured values in the data structure *MEAS_DATA* are not affected by error messages.

12.2.2 FB 325 - EM_COM_R1 - Communication with 031-1PAxx

Overview

This block enables the communication with the modules 031-1PAxx for energy metering and power measurement. For the communication a data block is necessary. Here the DB gets its structure from the UDT 325 EM_DATA_R1. The block has the following functionalities:

- Load default parameters after start-up
- Storage of parameters, limit values, measured values and messages
- Transfer of consistent measured values
- Writing set points
- Definition of the measured values by means of an UDT structure
- Communication by means of telegram type and ID
- Functional diagnostics, connection monitoring and error message evaluation

Parameter

Parameter	Declaration	Data type	Description
MODE	INPUT	BYTE	<ul style="list-style-type: none"> 0x01 = Data exchange via process data Currently only the MODE = 0x01 is supported
CHANNEL_IN	INPUT	ANY	Pointer to the input data <ul style="list-style-type: none"> With MODE = 0x01 exclusively data type BYTE and length 16 are permitted. Example: P#E100.0 BYTE 16 or P#DB10.DBX0.0 BYTE 16
CHANNEL_OUT	INPUT	ANY	Pointer to the output data <ul style="list-style-type: none"> With MODE = 0x01 exclusively data type BYTE and length 16 are permitted. Example: P#A100.0 BYTE 16 or P#DB10.DBX16.0 BYTE 16
MEAS_DATA	IN_OUT	UDT	<ul style="list-style-type: none"> UDT for the measured values ↗ <i>Chap. 12.2.3 'UDT 325 - EM_DATA_R1 - Data structure for FB 325' page 268</i> Please note that this structure must not be in the temporary local data!

12.2.3 UDT 325 - EM_DATA_R1 - Data structure for FB 325

12.2.3.1 Structure

UDT 325 The UDT 325 has a dynamic structure and has the following basic structure.

UDT areas	Description
UDT - Header	Structure for the header data
UDT - Data	Same data structure for the individual <i>measurands</i> . A <i>measurand</i> is a physical quantity that can be measured such as current, voltage and temperature. An overview of the measurands can be found in the manual for your energy measurement module.
...	
UDT - Data	
UDT - SetValue	Structure for the setpoint specification

UDT - Header	Declaration	Data type	Description
Timeout	INPUT	TIME	<ul style="list-style-type: none"> Timeout for job processing. If <i>Timeout</i> is exceeded, the job is aborted and a corresponding error message is output.
Polltime	INPUT	TIME	<ul style="list-style-type: none"> Interval for the periodic reading <i>Polltime</i> is only relevant if the measured values are periodically read in the interval of <i>Polltime</i>, i.e. if bit 0 of <i>Header.Control_Global</i> is set. If <i>Polltime</i> is less than the fastest possible interval, the measured values are read in the fastest possible interval.
Control_Global	INPUT	BYTE	0: de-activated, 1: activated <ul style="list-style-type: none"> Bit 0: Periodic execution according to the <i>Polltime</i> (default) Bit 1: Immediate execution - bit is reset after the execution. Bit 6 ... 2: reserved Bit 7: Re-initialization of the block by the configuration is sent again

UDT - Header	Declaration	Data type	Description
Status_Global	OUTPUT	BYTE	Block status <ul style="list-style-type: none"> 0x00: Not processed 0x01: In process (BUSY) 0x02: Ready without error (DONE) 0x80: Error on processing (ERROR)
Status Alarm_Global	OUTPUT	BYTE	Corresponds to B3: Header byte 3 - <i>Common status</i> <ul style="list-style-type: none"> Bit 0: Frequency F_{MAX} exceeded Bit 1: Frequency F_{MIN} undershot Bit 2: Temperature T_{MAX} exceeded Bit 3: Voltage $VRMS_{MAX}$ exceeded Bit 4: Voltage $VRMS_{MIN}$ undershot Bit 5: Efficiency PF_{MIN} undershot Bit 6: Current $IRMS_{MAX}$ exceeded Bit 7: reserved
Cmd	INPUT	BYTE	0: de-activated, 1: activated <ul style="list-style-type: none"> Bit 0: Reset all the energy counters Bit 1: Trigger reset on the current transformer Bit 2: Reset <i>status measurement</i> Bit 3: Writing the energy setpoints from "SetValues" to the ID3 ... ID8. <p>If several bits are set, they are sequentially processed.</p> <p>Note: Writing of energy set points requires a protocol version major ≥ 1 and minor ≥ 1!</p>
Status_Cmd	OUTPUT	BYTE	Status command <ul style="list-style-type: none"> 0x00: Not processed 0x01: In process (BUSY) 0x02: Ready without error (DONE) 0x80: Error on processing (ERROR) - see ERROR_ID
Jobtime	OUTPUT	TIME	<ul style="list-style-type: none"> Duration to read the measured values respectively to run a command.
DsID	OUTPUT	BYTE	Number of the current DS-ID ↪ ' <i>DS-ID</i> ' page 265
Frame_ID	OUTPUT	BYTE	Number of the current FR-ID ↪ ' <i>FR-ID</i> ' page 265
Error_ID	OUTPUT	WORD	Detailed error information
Status_ReadVersion	OUTPUT	BYTE	Status <i>Read FW Version</i> <ul style="list-style-type: none"> 0x00 = never executed 0x01: Busy 0x02: Done 0x80: Error
Reserved	STATIC	ARRAY of BYTE (1...15)	reserved
VersionInfo		Struct	The firmware version is determined automatically
FirmwareMajor	OUTPUT	Byte	Firmware version: Major
FirmwareMinor	OUTPUT	Byte	Firmware version: Minor
FirmwareRevision	OUTPUT	Byte	Firmware revision

Energy Measurement > UDT 325 - EM_DATA_R1 - Data structure for FB 325

UDT - Header	Declaration	Data type	Description
ProtocolMajor	OUTPUT	Byte	Protocol version: Major
ProtocolMinor	OUTPUT	Byte	Protocol version: Minor
ProtocolRevision	OUTPUT	Byte	Protocol version: Revision
ChipDateYear	OUTPUT	WORD	Date measuring chip: Year
ChipDateMonth	OUTPUT	Byte	Date measuring chip: Month
ChipDateDay	OUTPUT	Byte	Date measuring chip: Day

Same data structure for the individual *measurands*. An overview of the *measurands* can be found in the manual for your energy measurement module.

UDT - Data	Declaration	Data type	Description
Name	IN_OUT	STRUCT	■ Name of the <i>measurand</i>
Read_Mode	INPUT	BYTE	■ Bit 0: Accessing the measured value of the measurand – 0: Measured value should not be read. – 1: Measured value should be read.
Value	OUTPUT	DWORD	■ Current measured value

UDT - SetValue	Declaration	Data type	Description
SetValues		STRUCT	
EN_L1_CONSUMED	INPUT	DWORD	Setpoint active energy L1 consumer: UINT32, 1Wh
EN_L1_DELIVERED	INPUT	DWORD	Setpoint active energy L1 producer: UINT32, 1Wh
EN_L2_CONSUMED	INPUT	DWORD	Setpoint active energy L2 consumer: UINT32, 1Wh
EN_L2_DELIVERED	INPUT	DWORD	Setpoint active energy L2 producer: UINT32, 1Wh
EN_L3_CONSUMED	INPUT	DWORD	Setpoint active energy L3 consumer: UINT32, 1Wh
EN_L3_DELIVERED	INPUT	DWORD	Setpoint active energy L3 producer: UINT32, 1Wh
EXCESS_ACTIVE_EN_CONSUME	INPUT	DWORD	Setpoint for overflow energy meter phase 1 ... 3 consumer ■ 0xXX112233 – XX: not used – 11: Setpoint (byte) for overflow energy meter phase 1 consumer – 22: Setpoint (byte) for overflow energy meter phase 2 consumer – 33: Setpoint (byte) for overflow energy meter phase 3 consumer Is incremented by 1 in case of an overflow of the energy meter (ID = 1)
EXCESS_ACTIVE_EN_DELIVERED	INPUT	DWORD	Setpoint for overflow energy meter phase 1 ... 3 producer ■ 0xXX112233 – XX: not used – 11: Setpoint (byte) for overflow energy meter phase 1 producer – 22: Setpoint (byte) for overflow energy meter phase 2 producer – 33: Setpoint (byte) for overflow energy meter phase 3 producer Is incremented by 1 in case of an overflow of the energy meter (ID = 2)

12.2.3.2 Error messages

ERROR ID	Description
0x0000	no error
0x8060	Error: A more recent protocol version is required
0x8070	Error: Parameter MODE
0x8073	Error: Parameter CHANNEL_IN does not match MODE
0x8074	Error: Parameter CHANNEL_OUT does not match MODE
0x8080	Error: 'Set Frame': Timeout detected during access
0x8081	Error: 'Read Frame': Timeout detected during access
0x8082	Error: 'CMD Frame': Timeout detected during access
0x8083	Error: Timeout when automatically reading the firmware information
0x80A1	Status communication: Error: Record set could not be refreshed
0x80A2	Status communication: Error: 'DS-ID'
0x80A3	Status communication: Error: Telegram length
0x80A4	Status communication: Error: <i>Frame</i> too big
0x80A5	Status communication: Error: <i>Frame</i> not defined
0x80A6	Status communication: Error: Measurand not available
0x80A7	Status communication: 'CMD Frame' - Command could not be executed
0x80A8	Status communication: Error: 'Set Frame' - Frame definition is not valid (Set Frame)
0x80A9	Status communication: Error: Telegram type not available - invalid request
0x80AA	Status communication: Error: Parameter - the last parameter set was not valid
0x80AB	Error: Measuring module BUSY, no new data are transferred
0x80AE	External error - Please contact our support
0x80AF	Internal error: Due to a temporary disturbance during the processing of the measurement data, they could not be refreshed. If this error occurs more often, please contact our hotline.

12.3 Motion Modules

12.3.1 Overview

Blocks

The blocks listed below give you access to the System SLIO Motion modules:

- FB 320 - ACYC_RW - Acyclic access to the System SLIO motion module
- FB 321 - ACYC_DS - Acyclic parametrization System SLIO motion module
- UDT 321 - ACYC_OBJECT-DATA - Data structure for FB 321

Supported motion modules

The following System SLIO motion modules are supported:

- 054-1BA00: FM 054 Motion Module - Stepper
- 054-1CB00: FM 054 Motion Module - 2xDC
- 054-1DA00: FM 054 Motion Module - Pulse Train RS422

Index - Subindex

The System SLIO motion module provides its data, such as "Profiling target position" via an object dictionary. In this object dictionary the objects are organized and addressable a unique number consisting of *Index* and *Subindex*. The number is specified as follows:

0x	Index (hexadecimal)	-	Subindex (decimal)
Example: 0x8400-03			

 *To improve the structure and for expansion at System SLIO Motion Module another object numbering (index-assignment) is used besides the standard CiA 402.*

Index - areas

By separating into *Index* and *Subindex* a grouping is possible. The individual areas are divided into groups of related objects. This object dictionary is structured as follows for the System SLIO motion modules:

Index area	Content
0x1000 up to 0x6FFF	General data and system data
0x7000 up to 0x7FFF	Data of the digital input and output part
from 0x8000	Data of the axis or drives

 *Information about the structure of the object dictionary can be found in the manual of your motion module.*

 *Each object has a subindex 0. Calling an object with subindex 0, the number of available subindexes of the corresponding object is returned.*

I/O address range

The motion modules occupy a certain number of bytes in the I/O address area.

Head module	Backplane bus	Motion module	
CPU respectively bus coupler	→	Process data	Acyclic channel
	←		

Via the *Acyclic channel* you can perform acyclic read and write commands. For this in the input/output area of the motion modules a data area for the acyclic communication was implemented. This area includes 8bytes output and 8bytes input data. When the blocks are used, communication takes place via the *Acyclic channel*.

 *The data exchange with the motion module must be consistent over the length of the input or output data! It is recommended to control it via the process image. You can also use SFC 14 and 15 to consistently read and write the input or output data.*

Interconnecting the FBs

- During the configuration, make sure that the parameters CHANNEL_IN and CHANNEL_OUT of the FBs are correctly interconnected.
 - CHANNEL_IN is to be interconnected to the input data of the *Acyclic channel* of the motion module.
 - CHANNEL_OUT is to be interconnected to the output data of the *Acyclic channel* of the motion module.

Starting from the base address, the start address of the *Acyclic channel* for the input and output data can be reached via the following offset:

- 054-1BA00: FM 054 - Stepper: Base address + 26
- 054-1CB00: FM 054 - 2xDC: Base address + 50
- 054-1DA00: FM 054 - Pulse Train RS422: Base address + 26

Example with base address 256:

```
CHANNEL_IN    :=P#I 282.0 BYTE 10 // Base address 256 + 26
CHANNEL_OUT   :=P#Q 282.0 BYTE 10 // Base address 256 + 26
```



Please note that you specify a length of 10byte, although the Acyclic channel internally uses 8byte!

12.3.2 FB 320 - ACYC_RW - Acyclic access to the System SLIO motion module**Description**

With this block you can access the object dictionary of the System SLIO motion modules by means of your user program. Here the block uses an acyclic communication channel based on a request/response sequence. This is part of the input/output area of motion module.

The following System SLIO motion modules are supported:

- 054-1BA00: FM 054 - Stepper
- 054-1CB00: FM 054 - 2xDC
- 054-1DA00: FM 054 - Pulse Train RS422



Due to the FB 321 internally calls the FB 320 and both blocks access the same database, for each channel (if multi-channel) you can use only one of these blocks in your user program! Also this block must be called per cycle only once!



The data exchange with the motion module must be consistent over the length of the input or output data! It is recommended to control it via the process image. You can also use SFC 14 and 15 to consistently read and write the input or output data.

Parameters

Parameter	Declaration	Data type	Description
REQUEST	IN	BOOL	The job is started with edge 0-1.
MODE	IN	BYTE	Enter 0x01 for the acyclic protocol

Parameter	Declaration	Data type	Description
COMMAND	IN	BYTE	0x11 = Reading a data object (max. 4byte) 0x21 = Writing a data object (max. 4byte)
INDEX	IN	WORD	Index of the object in the object dictionary - see the manual for the System SLIO motion module.
SUBINDEX	IN	BYTE	Subindex of the object dictionary - see the manual for the System SLIO motion module.
WRITE_LENGTH	IN	DINT	Length of the data to be written in byte (max. 4byte)
WRITE_DATA	IN	ANY	Pointer to the data to be written.
READ_DATA	IN	ANY	Pointer to the received data.
CHANNEL_IN	IN	ANY	Pointer to the beginning of the acyclic channel in the input area of the motion module. Enter as length 10bytes. Examples P#I100.0 BYTE 10 or P#DB10.DBX0.0 BYTE 10
CHANNEL_OUT	IN	ANY	Pointer to the beginning of the acyclic channel in the output area of the motion module. Enter as length 10bytes. Examples P#Q100.0 BYTE 10 or P#DB10.DBX10.0 BYTE 10
READ_LENGTH	OUT	DINT	Length of the received data in byte. This value is to be rounded up to a multiple of 4, because the length specification is not transmitted.
DONE	OUT	BOOL	1: Job has been executed without error
BUSY	OUT	BOOL	0: There is no job being executed 1: Job is currently being executed
ERROR	OUT	BOOL	0: No Error 1: There is an error. The cause of the error is shown on the <i>ERROR_ID</i> parameter
ERROR_ID	OUT	WORD	Detailed error information



Please note that the parameters *WRITE_DATA* and *READ_DATA* are not checked for data type and length!

Behavior of the block parameters

- Exclusiveness of the outputs
 - The outputs *BUSY*, *DONE* and *ERROR* are mutually exclusive. There can only one of these outputs be TRUE at the same time.
 - As soon as the input *REQUEST* is TRUE, one of the outputs must be TRUE.
- Output status
 - The outputs *DONE*, *ERROR*, *ERROR_ID* and *READ_LENGTH* are reset by an edge 1-0 at the input *REQUEST*, when the function block is not active (*BUSY* = FALSE).
 - An edge 1-0 at *REQUEST* does not affect the job processing.
 - If *REQUEST* is already reset during job processing, so it is guaranteed that one of the outputs is set at the end of the command for a PLC cycle. Only then the outputs are reset.

- Input parameter
 - The input parameters are taken with edge 0-1 at *REQUEST*. To change parameters, you have to trigger the job again.
 - If there is again an edge 0-1 at *REQUEST* during the job processing, an error is reported, no new command is activated and the answer rejected by the current command!
- Error handling
 - The block has 2 error outputs for displaying errors during order processing. *ERROR* indicates the error and *ERROR_ID* shows an additional error number.
 - The outputs *DONE* and *READ_LENGTH* designates a successful command execution and are not set when *ERROR* becomes TRUE.
- Behavior of the *DONE* output
 - The *DONE* output is set, when a command was successfully executed.
- Behavior of the *BUSY* output
 - The *BUSY* output indicates that the function block is active.
 - Busy is immediately set with edge 0-1 of *REQUEST* and will not be reset until the job was completed successfully or failed.
 - As long as *BUSY* is TRUE, the function block must be called cyclically to execute the command.









If there is again an edge 0-1 at REQUEST during the job processing, an error is reported, no new command is activated and the answer rejected by the current command!

ERROR_ID

ERROR_ID	Description
0x0000	There is no Error
0x8070	Faulty parameter <i>MODE</i>
0x8071	Faulty parameter <i>COMMAND</i>
0x8072	Parameter <i>WRITE_LENGTH</i> exceeds the maximum size
0x8073	Parameter <i>CHANNEL_IN</i> does not fit the parameter <i>MODE</i>
0x8074	Parameter <i>CHANNEL_OUT</i> does not fit the parameter <i>MODE</i>
0x8075	Impermissible command (edge 0-1 at <i>REQUEST</i> during job is executed)
0x8081	Error - read access - data do not exist Command rejected!
0x8091	Error - write access - data do not exist Command rejected!
0x8092	Error - write access - data out of range Command rejected!
0x8093	Error - write access - data can only be read Command rejected!
0x8094	Error - write access - data are write protected Command rejected!
0x8099	Error during acyclic communication Command rejected!

Program structure

If no job is active, all output parameters must be set to 0. With an edge 0-1 at *REQUEST*, with the following approach a job is activated:

1.  Check if a job is already active, if necessary terminate job and output error.
 - ⇒ Check for DONE = 1 or BUSY = 0
2.  Interconnect the input parameters:
 - MODE
 - COMMAND
 - WRITE_LENGTH
 - CHANNEL_IN
 - CHANNEL_OUT
 - ⇒ Terminate job on error, otherwise continue with step 3.
3.  Save input parameters internally.
4.  Execute the desired command and wait until this has been carried out.
5.  Save and output the result of the command execution internally.
6.  Set all the output parameter to 0.

12.3.3 FB 321 - ACYC_DS - Acyclic parametrization System SLIO motion module

Description

With this block you can parametrize you motion module motion module by means of your user program. Here you can store your parameters as *Object list* in a data block an transfer them via the acyclic communication channel in your motion module

The following System SLIO modules are supported:

- 054-1BA00: FM 054 motion module - Stepper
- 054-1CB00: FM 054 motion module - 2xDC
- 054-1DA00: FM 054 motion module - Pulse Train RS422



Due to the FB 321 internally calls the FB 320 and both blocks access the same database, for each channel (if multi-channel) you can use only one of these blocks in your user program! Also this block must be called per cycle only once!

Parameters

Parameter	Declaration	Data type	Description
REQUEST	IN	BOOL	The job is started with edge 0-1.
MODE	IN	BYTE	Enter 0x01 for the acyclic protocol.
READ_BACK	IN	BOOL	0: Written objects are not read back. 1: Written objects are read back immediately after the write operation and compared.
GROUP	IN	WORD	0x01...0x7F: Selection of a group in the object list. 0xFF: Section of all the objects in the object list.
OBJECT_DATA	IN	ANY	Pointer to the UDT.  <i>Chap. 12.3.4 'UDT 321 - ACYC_OBJECT-DATA - Data structure for FB 321' page 279</i>

Parameter	Declaration	Data type	Description
CHANNEL_IN	IN	ANY	Pointer to the beginning of the acyclic channel in the input area of the motion module. Enter as length 10bytes. Examples P#I100.0 BYTE 10 or P#DB10.DBX0.0 BYTE 10
CHANNEL_OUT	IN	ANY	Pointer to the beginning of the acyclic channel in the output area of the motion module. Enter as length 10bytes. Examples P#Q100.0 BYTE 10 or P#DB10.DBX10.0 BYTE 10
DONE	OUT	BOOL	1: Job has been executed without error.
BUSY	OUT	BOOL	0: There is no job being executed. 1: Job is currently being executed.
DATASET_INDEX	OUT	INT	Object that is currently being processed.
ERROR	OUT	BOOL	0: No Error 1: There is an error. The cause of the error is shown on the <i>ERROR_ID</i> parameter.
ERROR_ID	OUT	WORD	Detailed error information

Behavior of the block parameters

- Exclusiveness of the outputs:
 - The outputs *BUSY*, *DONE* and *ERROR* are mutually exclusive. There can only one of these outputs be TRUE at the same time.
 - As soon as the input *REQUEST* is TRUE, one of the outputs must be TRUE.
- Output status
 - The outputs *DONE*, *ERROR*, *ERROR_ID* and *DATASET_INDEX* are reset by an edge 1-0 at the input *REQUEST*, when the job is finished.
 - If *REQUEST* is already reset during job processing, so it is guaranteed that the whole object list is processed.
 - At the end of the job with no error, *DONE* is set for one PLC cycle. Only then the outputs are reset.
- Input parameter
 - The input parameters are taken with edge 0-1 at *REQUEST*. To change parameters, you have to trigger the job again.
 - If there is again an edge 0-1 at *REQUEST* during the job, an error is reported (invalid command sequence) and the processing of the object list is finished.
- Input parameter *READ_BACK*
 - With activated parameter *READ_BACK* written objects are read back immediately after the write operation by a read job.
 - The written and read values are compared.
If they are identical, the next object is handled
If they are not identical, an error message (*ERROR ID* = 0x8079) is returned and the development of the object list is finished.
- Input parameter *GROUP*
 - For a better structure you can assign a group to each object.
 - Via *GROUP* you define the group whose parameters are to be transferred.
0x01...0x7F: Transfer the objects of the selected group.
0xFF: Transfer the objects of all the groups.

- Error handling
 - The block has error outputs to show errors during job processing. *ERROR* indicates the error, *ERROR_ID* shows an additional error number and *DATASET_INDEX* informs at which object the error occurred.
 - The output *DONE* designates a successful job execution and is not set when *ERROR* becomes TRUE.
- Behavior of the *DONE* output
 - The *DONE* output is set, when a command was successfully executed.
- Behavior of the *BUSY* output
 - The *BUSY* output indicates that the function block is active.
 - *BUSY* is immediately set with edge 0-1 of *REQUEST* and will not be reset until the job was completed successfully or failed.
 - As long as *BUSY* is TRUE, the function block must be called cyclically to execute the command.
- Behavior of the *DATASET_INDEX* output
 - The *DATASET_INDEX* output indicates, which object of the object list is currently being processed.
 - If there is no job active, *DATASET_INDEX* = 0 is returned.
 - If there is an error during the object processing, *DATASET_INDEX* shows the faulting object.



If there is again an edge 0-1 at REQUEST during the job processing, an error is reported (ERROR_ID = 0x8075), no new command is activated and the answer rejected by the current command!

Status diagram

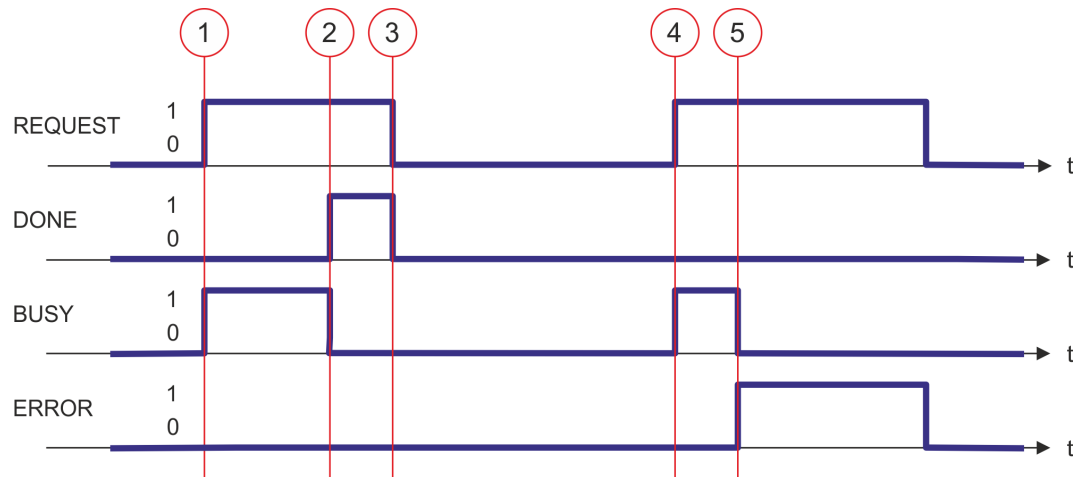

- (1) The job is started with edge 0-1 at *REQUEST* and *BUSY* becomes TRUE.
- (2) At the time (2) the job is completed. *BUSY* has the value FALSE and *DONE* den value TRUE.
- (3) At the time (3) the job is completed and *REQUEST* becomes FALSE and thus each output parameter FALSE respectively 0.
- (4) At the time (4) with an edge 0-1 at *REQUEST* the job is started again and *BUSY* becomes TRUE.
- (5) At the time (5) an error occurs during the job. *BUSY* has the value FALSE and *ERROR* den value TRUE.

ERROR_ID

ERROR_ID	Description
0x0000	There is no Error
0x8070	Faulty parameter <i>MODE</i>

ERROR_ID	Description
0x8071	Faulty parameter <i>OBJECT_DATA</i>
0x8075	Invalid command (edge 0-1 at <i>REQUEST</i> during job is executed)
0x8078	Faulty parameter <i>GROUP</i>
0x8079	<i>READ_BACK</i> detects an error (written and read value unequal)
0x807A	Pointer at <i>OBJECT_DATA</i> not valid



Within the function block the FB 320 is called. Here, any error of the FB 320 is passed to the FB 321. ↪ 'ERROR_ID' page 275

12.3.4 UDT 321 - ACYC_OBJECT-DATA - Data structure for FB 321

Data structure for the object list

The parameters are to be stored in a data block as *object list*, which consists of individual *objects*. The structure of an *objects* is defined via an UDT.

Structure of an object

Variable	Declaration	Data type	Description
Group	IN	WORD	0 < <i>Group</i> < 0x80 permitted
COMMAND	IN	BYTE	0x11 = Read from the object list 0x21 = Write to the object list
Index	IN	WORD	Index of the object
Subindex	IN	BYTE	Subindex of the object
Write_Length	IN	BYTE	Length of the data to be written in byte
Data_Write	IN	DWORD	Data to be written.
Data_Read	OUT	DWORD	Read data
State	OUT	BYTE	0x00 = never processed 0x01 = <i>BUSY</i> - in progress 0x02 = <i>DONE</i> - successfully processed 0x80 = <i>ERROR</i> - an error has occurred during the processing



Please note that you always specify the appropriate length for the object during a write job!

Example DB

Addr.	Name	Type	Start value	Current value	Comment
0.0	Object(1).Group	WORD			1. Object
2.0	Object(1).Command	BYTE			

RAM to WLD - "WLD" > FB 241 - RAM_to_autoload.wld - RAM to autoload.wld

Addr.	Name	Type	Start value	Current value	Comment
4.0	Object(1).Index	WORD			
6.0	Object(1).Subindex	BYTE			
7.0	Object(1).Write_Length	BYTE			
8.0	Object(1).Data_Write	DWORD			
12.0	Object(1).Data_Read	DWORD			
16.0	Object(1).State	BYTE			
18.0	Object(2).Group	WORD			2. Object
...			
34.0	Object(2).State	BYTE			
36.0	Object(3).Group	WORD			3. Object
...			
52.0	Object(3).State	BYTE			
...

12.4 RAM to WLD - "WLD"

12.4.1 FB 240 - RAM_to_s7prog.wld - RAM to s7prog.wld

Description

With *REQ* = TRUE this block copies the currently loaded project of a CPU on an inserted memory card as s7prog.wld. With a SPEED7 CPU from VIPA the s7prog.wld is automatically read from an inserted memory card always after an overall reset. The FB 240 internally calls the block SFB 239 with the corresponding parameters. Here the values of *BUSY* and *RET_VAL* are returned from the SFB 239 to the FB 240.



Please note that this block is not part of the library for the Siemens TIA Portal.

Parameters

Parameter	Declaration	Data type	Memory area	Description
REQ	IN	BOOL	I, Q, M, D, L	Function request with <i>REQ</i> = 1
BUSY	OUT	BOOL	I, Q, M, D, L	Return value of the SFB 239
RET_VAL	OUT	WORD	I, Q, M, D, L	Return value of the SFB 239

12.4.2 FB 241 - RAM_to_autoload.wld - RAM to autoload.wld

Description

With *REQ* = TRUE this block copies the currently loaded project of a CPU on an inserted memory card as autoload.wld. With a SPEED7 CPU from VIPA the s7prog.wld is automatically read from an inserted memory card always after PowerON. The FB 241 internally calls the block SFB 239 with the corresponding parameters. Here the values of *BUSY* and *RET_VAL* are returned from the SFB 239 to the FB 241.



Please note that this block is not part of the library for the Siemens TIA Portal.

Parameters

Parameter	Declaration	Data type	Memory area	Description
REQ	IN	BOOL	I, Q, M, D, L	Function request with <i>REQ</i> = 1
BUSY	OUT	BOOL	I, Q, M, D, L	Return value of the SFB 239
RET_VAL	OUT	WORD	I, Q, M, D, L	Return value of the SFB 239

12.5 Onboard I/O System 100V

12.5.1 SFC 223 - PWM - Pulse duration modulation

Description

This block serves the parameterization of the pulse duration modulation for the last two output channels of X5.



Please note that this block is not part of the library for the Siemens TIA Portal.

Parameters

Parameter	Declaration	Type	Description
CHANNEL	IN	INT	Number of the output channel for PWM
ENABLE	IN	BOOL	Start bit of the job
TIMEBASE	IN	INT	Time base
PERIOD	IN	DINT	Period of the PWM
DUTY	IN	DINT	Output value per mille
MINLEN	IN	DINT	Minimum pulse duration
RET_VAL	OUT	WORD	Return value (0 = OK)

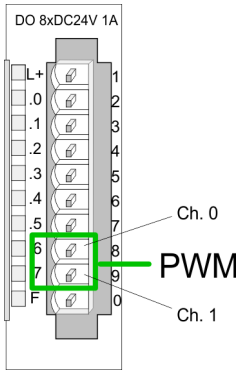

→ You define a time base, a period, the pulse duty ratio and min. pulse length. The CPU determines a pulse series with an according pulse/break relation and issues this via the according output channel.

⇒ The SFC returns a certain error code. You can see the concerning error messages in the table at the following page. The PWM parameters have the following relationship:

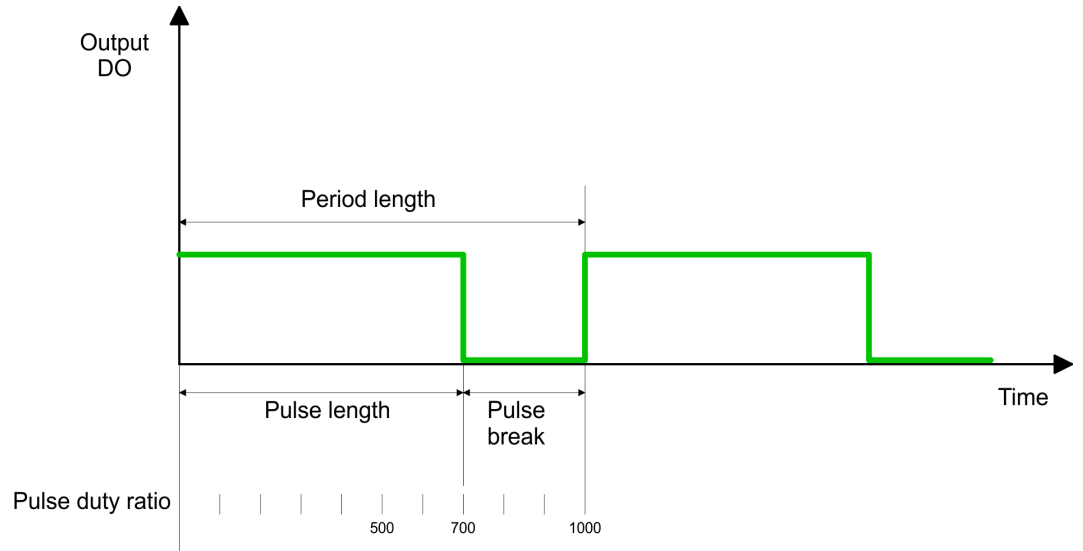

Period length = time base x period

Pulse length = (period length / 1000) x pulse duty ratio

Pulse break = period length - pulse length

The parameters have the following meaning:

CHANNEL

- Define the output channel that you want to address.
 - Value range: 0 ... 1

ENABLE

- Via this parameter you may activate the PWM function (true) res. deactivate it (false).
 - Value range: true, false

TIMEBASE

- *TIMEBASE* defines the resolution and the value range of the pulse, period and minimum pulse length per channel.
- You may choose the values 0 for 0.1ms and 1 for 1ms.
 - Value range: 0 ... 1

PERIOD

- Through multiplication of the value defined at period with the *TIMEBASE* you get the period length.
 - Value range: 0 ... 60000

- DUTY**
- This parameter shows the pulse duty ratio per mille. Here you define the relationship between pulse length and pulse break, concerned on one period.
 - 1 per mille = 1 *TIMEBASE*
 - If the calculated pulse duration is no multiplication of the *TIMEBASE*, it is rounded down to the next smaller *TIMEBASE* limit.
 - Value range: 0 ... 1000

- MINLEN**
- Via *MINLEN* you define the minimal pulse length. Switches are only made, if the pulse exceeds the here fixed minimum length.
 - Value range: 0 ... 60000

RET_VAL (Return Value) Via the parameter *RET_VAL* you get an error number in return. See the table below for the concerning error messages:

Value	Description
0000h	no error
8005h	Parameter <i>MINLEN</i> outside the permissible range
8006h	Parameter <i>DUTY</i> outside the permissible range
8007h	Parameter <i>PERIOD</i> outside the permissible range
8008h	Parameter <i>TIMEBASE</i> outside the permissible range
8009h	Parameter <i>CHANNEL</i> outside the permissible range.
9001h	Internal error - There was no valid address for a parameter.
9002h	Internal hardware error - Please contact the hotline.
9003h	Output is not configured as PWM output respectively there is an error in hardware configuration.
9004h	HF-PWM was configured but SFC 223 was called (please use SFC 225 HF_PWM!).

12.5.2 SFC 224 - HSC - High-speed-Counter

Description This SFC serves for parameterization of the counter functions (high speed counter) for the first 4 inputs.



Please note that this block is not part of the library for the Siemens TIA Portal.

Parameters

Parameter	Declaration	Type	Description
CHANNEL	IN	INT	Number of the input channel for HSC
ENABLE	IN	BOOL	Start bit of the job
DIRECTION	IN	INT	Direction of counting

Parameter	Declaration	Type	Description
PRESETVALUE	IN	DINT	Preset value
LIMIT	IN	DINT	Limit for counting
RET_VAL	OUT	WORD	Return value (0 = OK)
SETCOUNTER	IN_OUT	BOOL	Load preset value

CHANNEL

- Type the input channel that you want to activate as counter.
 - Value range: 0 ... 3

ENABLE

- Via this parameter you may activate the counter (true) res. deactivate it (false).
 - Value range: true, false

DIRECTION

- Fix the counting direction.
 - Hereby is:
 - 0: Counter is deactivated, means *ENABLE* = false
 - 1: count up
 - 2: count down

PRESETVALUE

- Here you may preset a counter content, that is transferred to the according counter via *SETCOUNTER* = true.
 - Value range: 0 ... FFFFFFFFh

LIMIT

- Via Limit you fix an upper res. lower limit for the counting direction (up res. down). When the limit has been reached, the according counter is set zero and started new. If necessary an alarm occurs.
 - Value range: 0 ... FFFFFFFFh

RET_VAL (Return Value)

Via the parameter *RET_VAL* you get an error number in return. See the table below for the concerning error messages:

Value	Description
0000h	No error
8002h	The chosen channel is not configured as counter (Error in the hardware configuration).
8008h	Parameter <i>DIRECTION</i> outside the permissible range
8009h	Parameter <i>CHANNEL</i> outside the permissible range
9001h	Internal error - There was no valid address for a parameter.
9002h	Internal hardware error - Please contact the hotline.

SETCOUNTER

- Per *SETCOUNTER* = true the value given by *PRESETVALUE* is transferred into the according counter.
- The bit is set back from the SFC.
 - Value range: true, false

12.5.3 SFC 225 - HF_PWM - HF pulse duration modulation

Description

This block serves the parameterization of the pulse duration modulation for the last two output channels. This block is function identical to SFC 223. Instead of *TIMEBASE* and *PERIOD*, the SFC 225 works with a predefined frequency (up to 50kHz).



Please note that this block is not part of the library for the Siemens TIA Portal.

Parameters

Parameter	Declaration	Type	Description
CHANNEL	IN	INT	Number of the output channel for HF-PWM
ENABLE	IN	BOOL	Start bit of the job
FREQUENCY	IN	WORD	Frequency of the HF-PWM
DUTY	IN	DINT	Pulse duty ratio per mille
MINLEN	IN	DINT	Minimum pulse duration
RET_VAL	OUT	WORD	Return value (0 = OK)

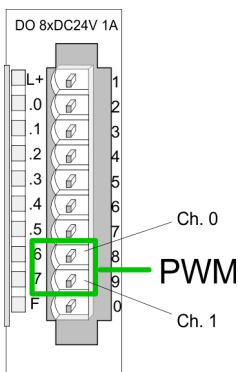

→ You define a time base, a period, the pulse duty ratio and min. pulse length. The CPU determines a pulse series with an according pulse/break relation and issues this via the according output channel.

⇒ The SFC returns a certain error code. You can see the concerning error messages in the table at the following page. The PWM parameters have the following relationship:

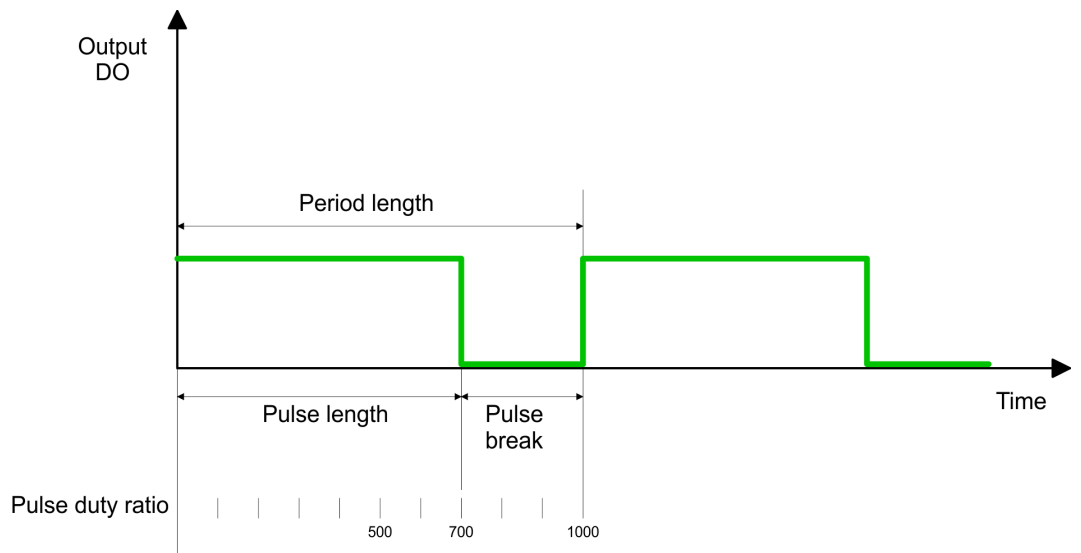

$$\text{Period length} = 1 / \text{frequency}$$

$$\text{Pulse length} = (\text{period length} / 1000) \times \text{pulse duty ratio}$$

$$\text{Pulse break} = \text{period length} - \text{pulse length}$$

- CHANNEL**
- Define the output channel that you want to address.
 - Value range: 0 ... 1
- ENABLE**
- Via this parameter you may activate the PWM function (true) res. deactivate it (false).
 - Value range: true, false
- FREQUENCE**
- Type in the frequency in Hz as hexadecimal value.
 - Value range: 09C4h ... C350h (2.5kHz ... 50kHz)
- DUTY**
- This parameter shows the pulse duty ratio per mille. Here you define the relationship between pulse length and pulse break, concerned on one period.
 - 1 per mille = 1 *TIMEBASE*
 - If the calculated pulse duration is no multiplication of the *TIMEBASE*, it is rounded down to the next smaller *TIMEBASE* limit.
 - Value range: 0 ... 1000
- MINLEN**
- Via *MINLEN* you define the minimal pulse length in μ s. Switches are only made, if the pulse exceeds the here fixed minimum length.
 - Value range: 0 ... 60000
- RET_VAL (Return Value)** Via the parameter *RET_VAL* you get an error number in return. See the table below for the concerning error messages:

Value	Description
0000h	no error
8005h	Parameter <i>MINLEN</i> outside the permissible range
8006h	Parameter <i>DUTY</i> outside the permissible range
8007h	Parameter <i>FREQUENCE</i> outside the permissible range
8008h	Parameter <i>TIMEBASE</i> outside the permissible range
8009h	Parameter <i>CHANNEL</i> outside the permissible range.
9001h	Internal error - There was no valid address for a parameter.
9002h	Internal hardware error - Please contact the hotline.
9003h	Output is not configured as PWM output respectively there is an error in hardware configuration.
9004h	HF-PWM was configured but SFC 223 was called (please use SFC 225 HF_PWM!).

13 Motion control - Simple Motion Control Library

13.1 Overview

Block library 'Simple Motion Control'

The block library can be found for download in the 'Service/Support' area of www.vipa.com at 'Downloads → VIPA Lib' as 'Block library Simple Motion Control - SW90MSOMA'. The library is available as packed zip file. As soon as you want to use these blocks you have to import them into your project.

Properties

With the *Simple Motion Control Library* blocks, you can easily integrate drives into your applications without detailed knowledge. Here various drives and bus systems are supported. The PLCopen blocks enable you to implement simple drive tasks in your control system. This system offers the following features:

- Can be used in *VIPA SPEED7 Studio* and Siemens SIMATIC Manager
- Implementation of simple drive functions
 - Switch on or off
 - Speed setting
 - Relative or absolute positioning
 - Homing
 - Read and write parameters
 - Query of axis position and status
- Easy commissioning and diagnostics without detailed knowledge of the drives
- Support of various drives and field buses
- Visualization of individual axes
- Scalable by using PLCopen blocks

Structure

The *Simple Motion Control Library* is divided into the following groups:

- Axis Control
 - General blocks for controlling the drives.
- Sigma5 EtherCAT
 - Specific blocks for the use of *Sigma-5* drives, which are connected via EtherCAT.
- Sigma7 EtherCAT
 - Specific blocks for the use of *Sigma-7S* drives, which are connected via EtherCAT.
 - Specific blocks for the use of *Sigma-7W* drives, which are connected via EtherCAT.
- Sigma5+7 PulseTrain
 - Specific block for the use of *Sigma-5* respectively *Sigma-7* drives, which are connected via Pulse Train.
- V1000 PWM
 - Specific block for the use of *V1000* inverter drives, which are connected via PWM.
- V1000 Modbus RTU
 - Specific blocks for the use of *V1000* inverter drives, which are connected via Modbus RTU.
- Inverter EtherCAT
 - Specific block for the use of inverter drives, which are connected via EtherCAT.

13.2 Usage Sigma-5/7 EtherCAT

13.2.1 Usage Sigma-5 EtherCAT

13.2.1.1 Overview

Precondition

- SPEED7 Studio from V1.6.1
or
- Siemens SIMATIC Manager from V 5.5, SP2 & *SPEED7 EtherCAT Manager & Simple Motion Control Library*
- CPU with EtherCAT master, e.g. CPU 015-CEFNR00
- *Sigma-5* drive with EtherCAT option card

Steps of configuration

1. Set the parameters on the drive
 - The setting of the parameters happens by means of the software tool *Sigma Win+*.
2. Hardware configuration in VIPA *SPEED7 Studio* or Siemens SIMATIC Manager
 - Configuring a CPU with EtherCAT master functionality.
 - Configuration of a *Sigma-5* EtherCAT drive.
 - Configuring the EtherCAT connection via *SPEED7 EtherCAT Manager*.
3. Programming in VIPA *SPEED7 Studio* or Siemens SIMATIC Manager
 - Connecting the *Init* block to configure the axis.
 - Connecting the *Kernel* block to communicate with the axis.
 - Connecting the blocks for the motion sequences.

13.2.1.2 Set the parameters on the drive

Parameter digits

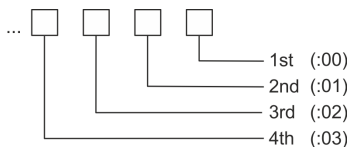

 **CAUTION!** Before the commissioning, you have to adapt your drive to your application with the *Sigma Win+* software tool! More may be found in the manual of your drive.

The following parameters must be set via *Sigma Win+* to match the *Simple Motion Control Library*:

Sigma-5 (20bit encoder)

Servopack Parameter	Address:digit	Name	Value
Pn205	(2205h)	Multiturn Limit Setting	65535
Pn20E	(220Eh)	Electronic Gear Ratio (Numerator)	1
Pn210	(2210h)	Electronic Gear Ratio (Denominator)	1
PnB02	(2701h:01)	Position User Unit (Numerator)	1
PnB04	(2701h:02)	Position User Unit (Denominator)	1
PnB06	(2702h:01)	Velocity User Unit (Numerator)	1
PnB08	(2702h:02)	Velocity User Unit (Denominator)	1

Servopack Parameter	Address:digit	Name	Value
PnB0A	(2703h:01)	Acceleration User Unit (Numerator)	1
PnB0C	(2703h:02)	Acceleration User Unit (Denominator)	1

13.2.1.3 Usage in VIPA SPEED7 Studio

13.2.1.3.1 Hardware configuration

Add CPU in the project

Please use for configuration the *SPEED7 Studio* V1.6.1 and up.

1. Start the *SPEED7 Studio*.

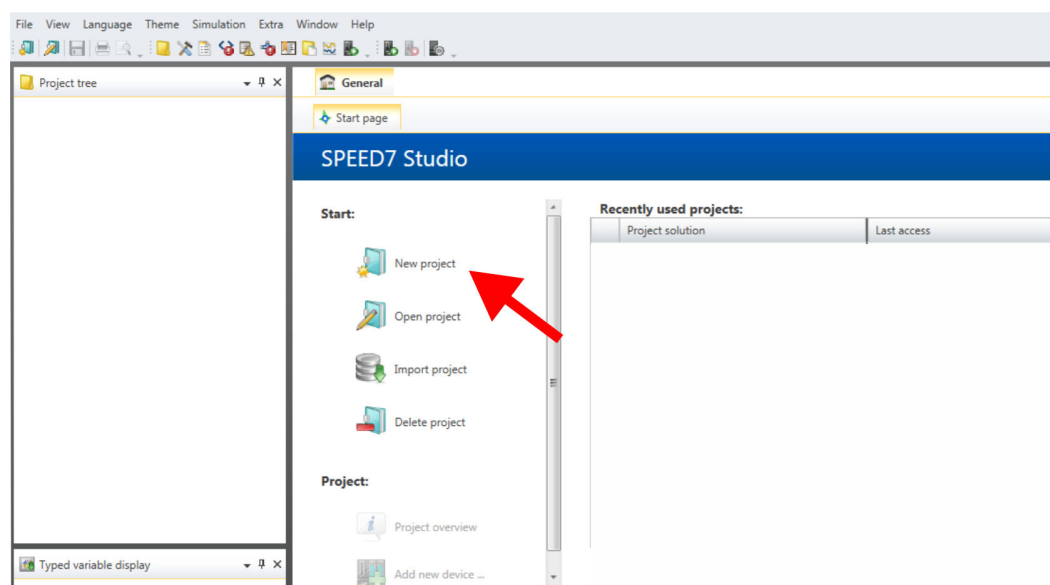

2. Create a new project at the start page with 'New project'.

⇒ A new project is created and the view 'Devices and networking' is shown.

3. Click in the *Project tree* at 'Add new device ...'.

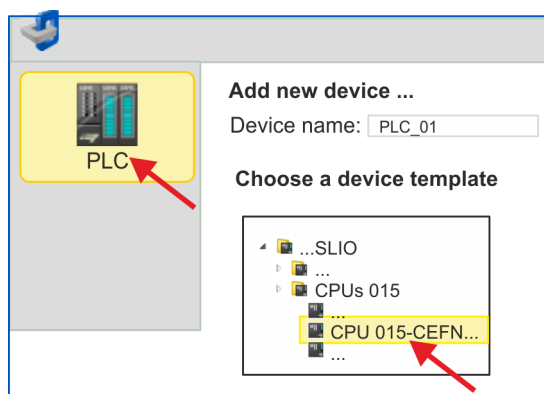
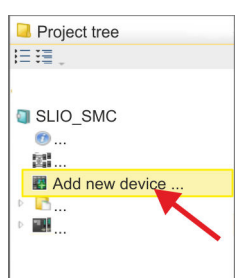

⇒ A dialog for device selection opens.

4. Select from the 'Device templates' a CPU with EtherCAT master functions such as CPU 015-CEFNR00 and click at [OK].

⇒ The CPU is inserted in 'Devices and networking' and the 'Device configuration' is opened.

Activate motion control functions

If the EtherCAT master functionality is not yet activated on your CPU, the activation takes place as follows:

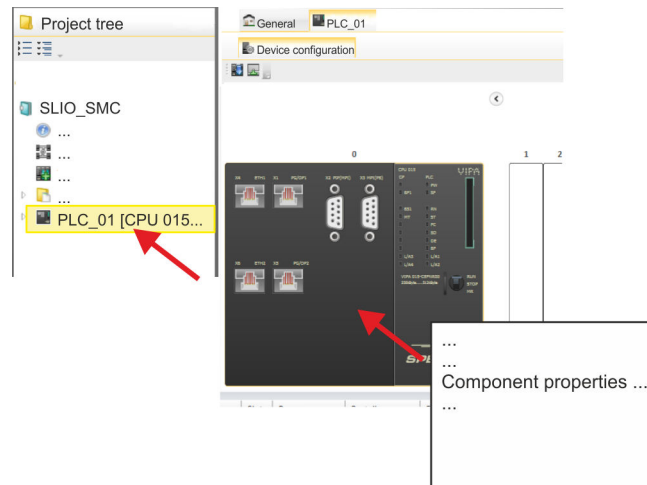

1. Click at the CPU in the 'Device configuration' and select 'Context menu' → 'Components properties'.

⇒ The properties dialog of the CPU is opened.

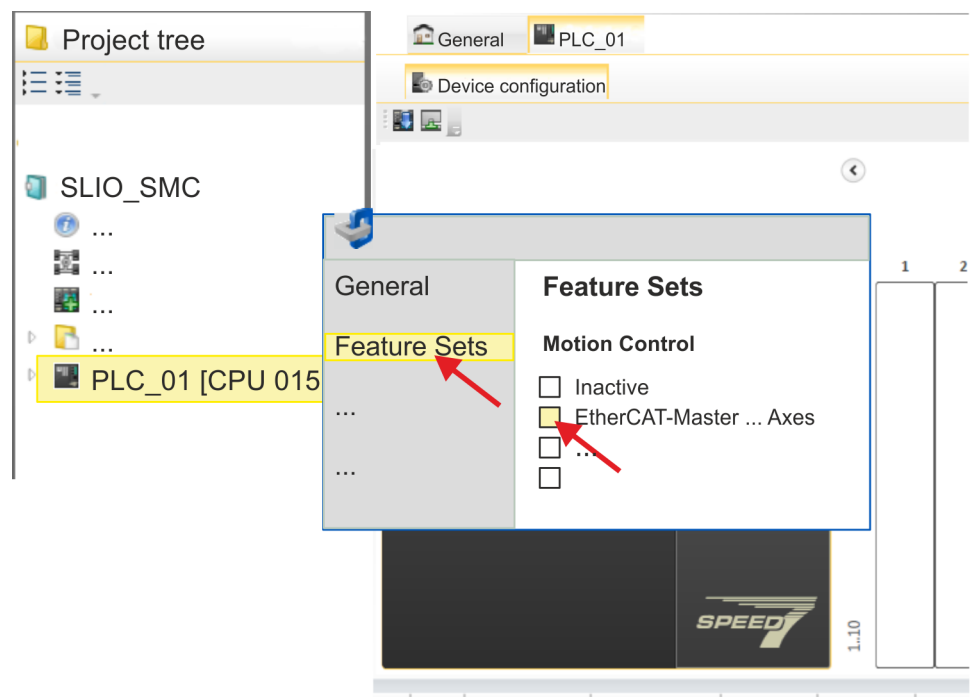

2. Click at 'Feature Sets' and activate at 'Motion Control' the parameter 'EtherCAT-Master... Axes'. The number of axes is not relevant in this example.

3. Confirm your input with [OK].

⇒ The motion control functions are now available in your project.

**CAUTION!**

Please note due to the system, with every change to the feature set settings, the EtherCAT field bus system and its motion control configuration will be deleted from your project!

Configuration of Ethernet PG/OP channel

1. Click in the *Project tree* at *'Devices and networking'*.
⇒ You will get a graphical object view of your CPU.

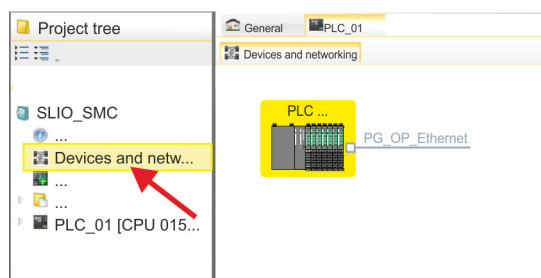

2. Click at the network *'PG_OP_Ethernet'*.
3. Select *'Context menu → Interface properties'*.
⇒ A dialog window opens. Here you can enter the IP address data for your Ethernet PG/OP channel. You get valid IP address parameters from your system administrator.
4. Confirm with [OK].
⇒ The IP address data are stored in your project listed in *'Devices and networking'* at *'Local components'*.
After transferring your project your CPU can be accessed via Ethernet PG/OP channel with the set IP address data.

Installing the ESI file

For the *Sigma-5* EtherCAT drive can be configured in the *SPEED7 EtherCAT Manager*, the corresponding ESI file must be installed. Usually, the *SPEED7 Studio* is delivered with current ESI files and you can skip this part. If your ESI file is not up-to date, you will find the latest ESI file for the *Sigma-5* EtherCAT drive under www.yaskawa.eu.com at *'Service → Drives & Motion Software'*.

1. Download the according ESI file for your drive. Unzip this if necessary.
2. Navigate to your *SPEED7 Studio*.
3. Open the corresponding dialog window by clicking on *'Extra → Install device description (EtherCAT - ESI)'*.
4. Under *'Source path'*, specify the ESI file and install it with [Install].
⇒ The devices of the ESI file are now available.

Add a *Sigma-5* drive

1. Click in the *Project tree* at *'Devices and networking'*.
2. Click here at *'EC-Mastersystem'* and select *'Context menu → Add new device'*.

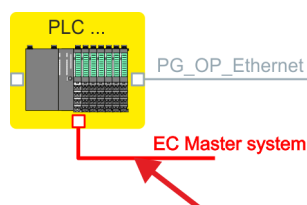

- ⇒ The device template for selecting an EtherCAT device opens.

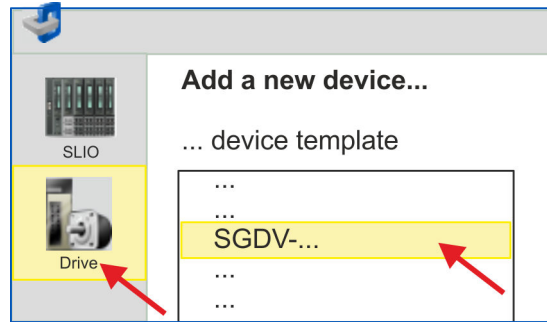

3. Select your *Sigma-5* drive:

- SGDV-xxxxE5...
- SGDV-xxxxE1...

Confirm with [OK]. If your drive does not exist, you must install the corresponding ESI file as described above.

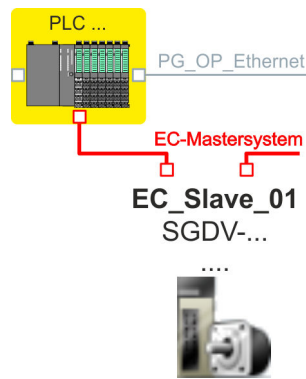

⇒ The *Sigma-5* drive is connected to your EC-Mastersystem.

Configure Sigma-5 drive

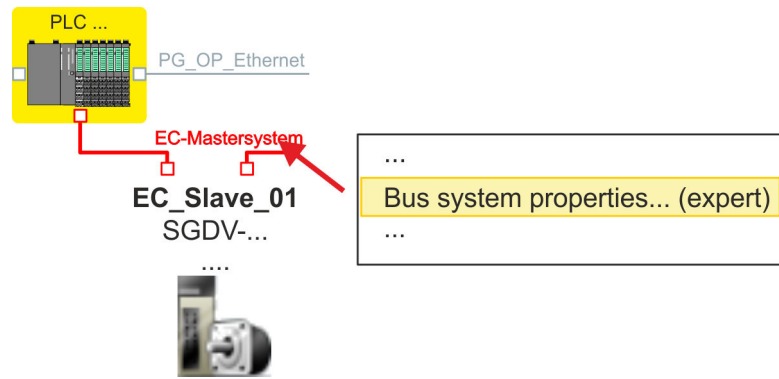

1. Click here at 'EC-Mastersystem' and select 'Context menu' → 'Bus system properties (expert)'.

i You can only edit PDOs in 'Expert mode'! Otherwise, the buttons are hidden.

- ⇒ The SPEED7 EtherCAT Manager opens. Here you can configure the EtherCAT communication to your Sigma-5 drive.

More information about the usage of the SPEED7 EtherCAT Manager may be found in the online help of the SPEED7 Studio.

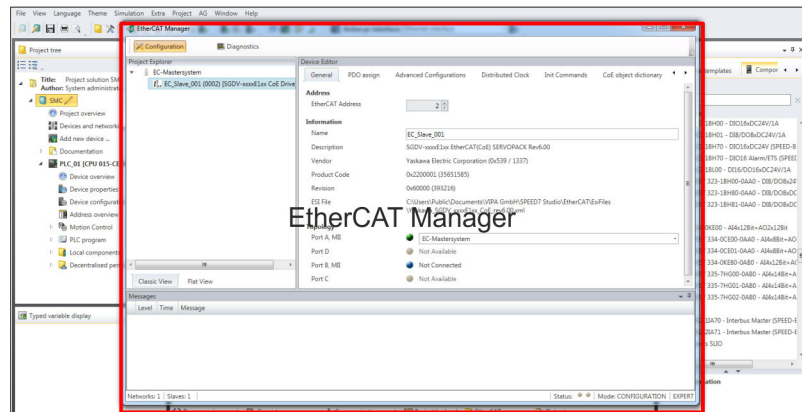

2. Click on the slave in the SPEED7 EtherCAT Manager and select the 'PDO assign' tab in the 'Device editor'.

EtherCAT Manager	
Project Explorer	Device Editor
<ul style="list-style-type: none"> EC-Mastersystem <ul style="list-style-type: none"> EC_Slave_001 	<p>PDO assign</p> <p>Inputs</p> <p><input type="checkbox"/> 1st Transmit PDO mapping</p>

- ⇒ This dialog shows a list of the PDOs.

3. By selecting the appropriate mapping, you can edit the PDOs with [Edit]. Select the mapping '1st Transmit PDO mapping' and click at [Edit].

i Please note that some PDOs can not be edited because of the default settings. By de-activating already activated PDOs, you can release the processing of locked PDOs.

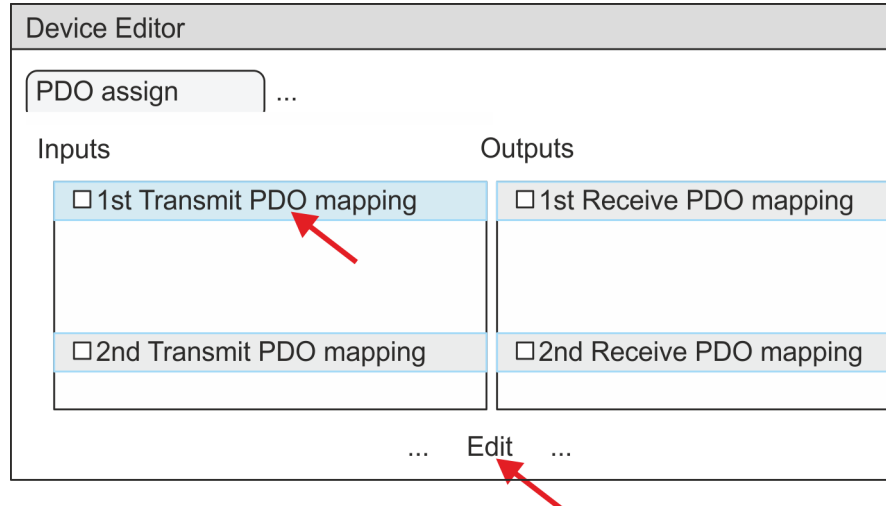

- ⇒ The dialog 'Edit PDO' is opened. Please check the PDO settings listed here and adjust them if necessary. Please also take into account the order of the 'Entries' and add them accordingly.

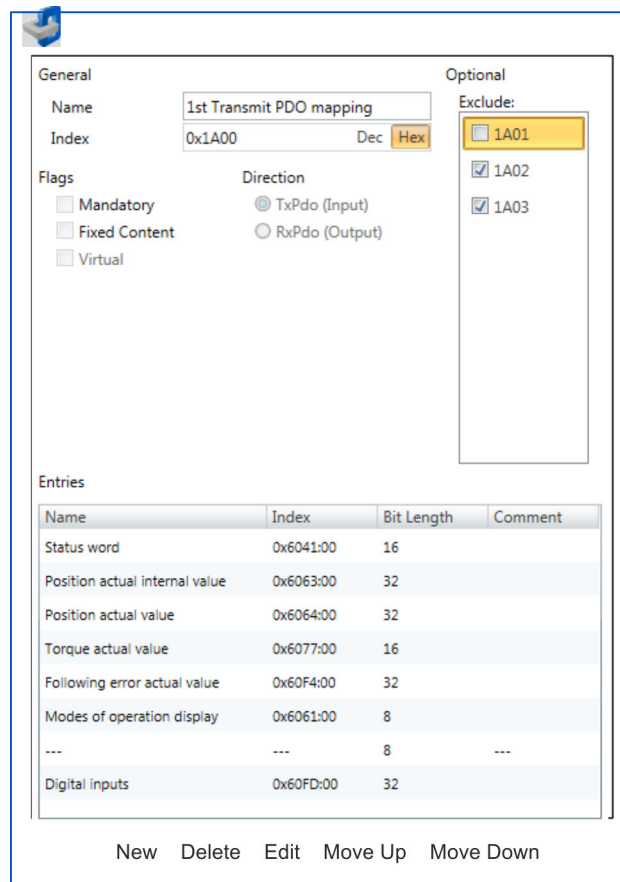

The following functions are available for editing the 'Entries':

- New
 - Here you can create a new entry in a dialog by selecting the corresponding entry from the 'CoE object dictionary' and making your settings. The entry is accepted with [OK] and is listed in the list of entries.
- Delete
 - This allows you to delete a selected entry.
- Edit
 - This allows you to edit the general data of an entry.
- Move Up/Down
 - This allows you to move the selected entry up or down in the list.

4. ► Perform the following settings:

Inputs: 1st Transmit PDO 0x1A00

- General
 - Name: 1st Transmit PDO mapping
 - Index: 0x1A00
- Flags
 - Everything de-activated
- Direction
 - TxPdo (Input): activated
- Exclude

Please note these settings, otherwise the PDO mappings can not be activated at the same time!

 - 1A01: de-activated
- Entries

Name	Index	Bit length
Status word	0x6041:00	16bit
Position actual internal value	0x6063:00	32bit
Position actual value	0x6064:00	32bit
Torque actual value	0x6077:00	16bit
Following error actual value	0x60F4:00	32bit
Modes of operation display	0x6061:00	8bit
---	---	8bit
Digital inputs	0x60FD:00	32bit

Close the dialog 'Edit PDO' with [OK].

5. → Select the mapping '2nd Transmit PDO mapping' and click at [Edit]. Perform the following settings:

Inputs: 2nd Transmit PDO 0x1A01

- General
 - Name: 2nd Transmit PDO mapping
 - Index: 0x1A01
- Flags
 - Everything de-activated
- Direction
 - TxPdo (Input): activated
- Exclude

Please note these settings, otherwise the PDO mappings can not be activated at the same time!

- 1A00: de-activated
- 1A02: de-activated
- 1A03: de-activated

- Entries

Name	Index	Bit length
Touch probe status	0x60B9:00	16bit
Touch probe 1 position value	0x60BA:00	32bit
Touch probe 2 position value	0x60BC:00	32bit
Velocity actual value	0x606C:00	32bit

Close the dialog 'Edit PDO' with [OK].

6. Select the mapping '1st Receive PDO mapping' and click at [Edit]. Perform the following settings:

Outputs: 1st Receive PDO 0x1600

- General
 - Name: 1st Receive PDO mapping
 - Index: 0x1600
- Flags
 - Everything de-activated
- Direction
 - RxPdo (Output): activated
- Exclude

Please note these settings, otherwise the PDO mappings can not be activated at the same time!

 - 1601: de-activated
 - 1602: de-activated
 - 1603: de-activated
- Entries

Name	Index	Bit length
Control word	0x6040:00	16bit
Target position	0x607A:00	32bit
Target velocity	0x60FF:00	32bit
Modes of operation	0x6060:00	8bit
---	---	8bit
Touch probe function	0x60B8:00	16bit

Close the dialog 'Edit PDO' with [OK].

7. Select the mapping '2nd Receive PDO mapping' and click at [Edit]. Perform the following settings:

Outputs: 2nd Receive PDO 0x1601

- General
 - Name: 2nd Receive PDO mapping
 - Index: 0x1601
- Flags
 - Everything de-activated
- Direction
 - RxPdo (Output): activated
- Exclude

Please note these settings, otherwise the PDO mappings can not be activated at the same time!

 - 1600: de-activated
 - 1602: activated
 - 1603: activated
- Entries
 - Profile velocity: 0x6081:00 → 32 Bit
 - Profile acceleration: 0x6083:00 → 32 Bit
 - Profile deceleration: 0x6084:00 → 32 Bit

Close the dialog 'Edit PDO' with [OK].

8. In PDO assignment, activate the PDOs 1 and 2 for the inputs and outputs. All subsequent PDOs must remain de-activated. If this is not possible, please check the respective PDO parameter 'Exclude'.

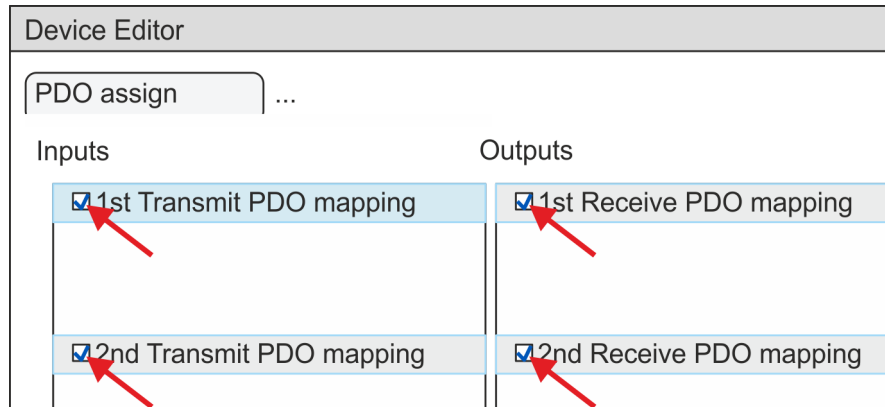

9. In the 'Device Editor' of the SPEED7 EtherCAT Manager, select the 'Distributed clocks' tab and set 'DC unused' as 'Operating mode'.

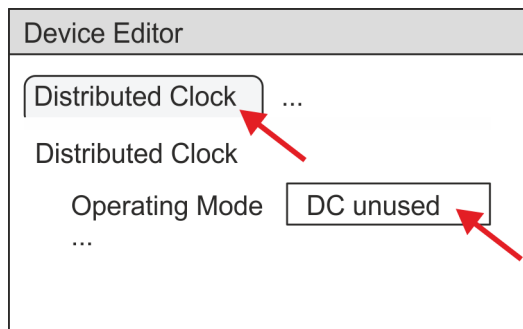

10. Select the 'Process image' tab via the arrow key in the 'Device editor' and note for the parameter of the block FB 871 - VMC_InitSigma5_EC the following PDO.

- 'S7 Input address' → 'InputsStartAddressPDO'
- 'S7 Output address' → 'OutputsStartAddressPDO'

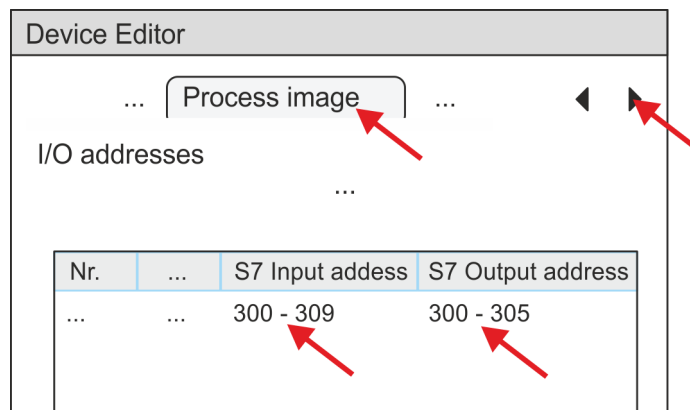

11. By closing the dialog of the SPEED7 EtherCAT Manager with [X] the configuration is taken to the SPEED7 Studio.

13.2.1.3.2 User program

Program structure

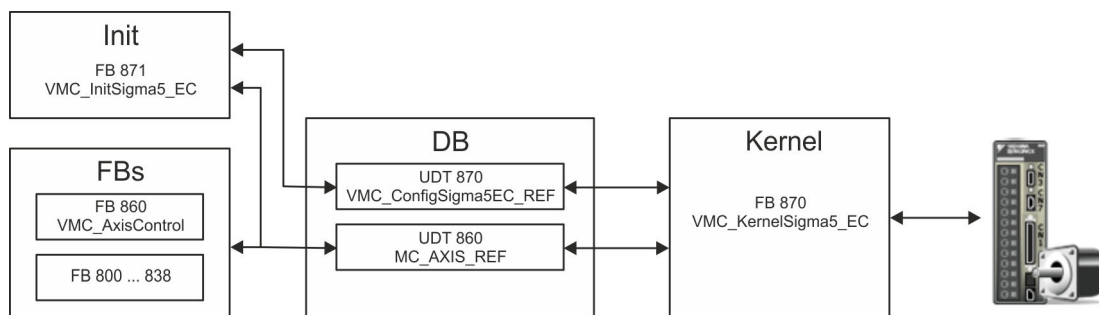

- **DB**
 - A data block (axis DB) for configuration and status data must be created for each axis of a drive. The data block consists of the following data structures:
 - UDT 870 - *VMC_ConfigSigma5EC_REF*
The data structure describes the structure of the configuration of the drive. Specific data structure for *Sigma-5* EtherCAT.
 - UDT 860 - *MC_AXIS_REF*
The data structure describes the structure of the parameters and status information of drives. General data structure for all drives and bus systems.
- **FB 871 - *VMC_InitSigma5_EC***
 - The *Init* block is used to configure an axis.
 - Specific block for *Sigma-5* EtherCAT.
 - The configuration data for the initialization must be stored in the *axis DB*.
- **FB 870 - *VMC_KernelSigma5_EC***
 - The *Kernel* block communicates with the drive via the appropriate bus system, processes the user requests and returns status messages.
 - Specific block for *Sigma-5* EtherCAT.
 - The exchange of the data takes place by means of the *axis DB*.
- **FB 860 - *VMC_AxisControl***
 - General block for all drives and bus systems.
 - Supports simple motion commands and returns all relevant status messages.
 - The exchange of the data takes place by means of the *axis DB*.
 - For motion control and status query, via the instance data of the block you can link a visualization.
 - In addition to the FB 860 - *VMC_AxisControl*, *PLCopen* blocks can be used.
- **FB 800 ... FB 838 - *PLCopen***
 - The *PLCopen* blocks are used to program motion sequences and status queries.
 - General blocks for all drives and bus systems.

Programming

Copy blocks into project

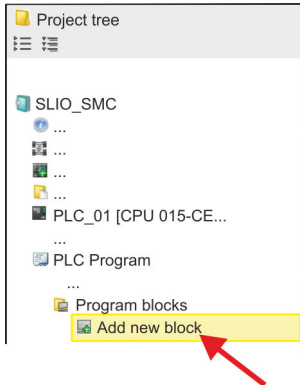

1. Click in the *Project tree* within the CPU at '*PLC program*', '*Program blocks*' at '*Add New block*'.

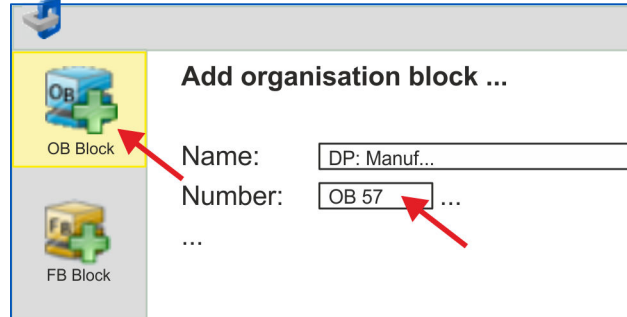

⇒ The dialog '*Add block*' is opened.

2. Select the block type '*OB block*' and add OB 57, OB 82 and OB 86 to your project.

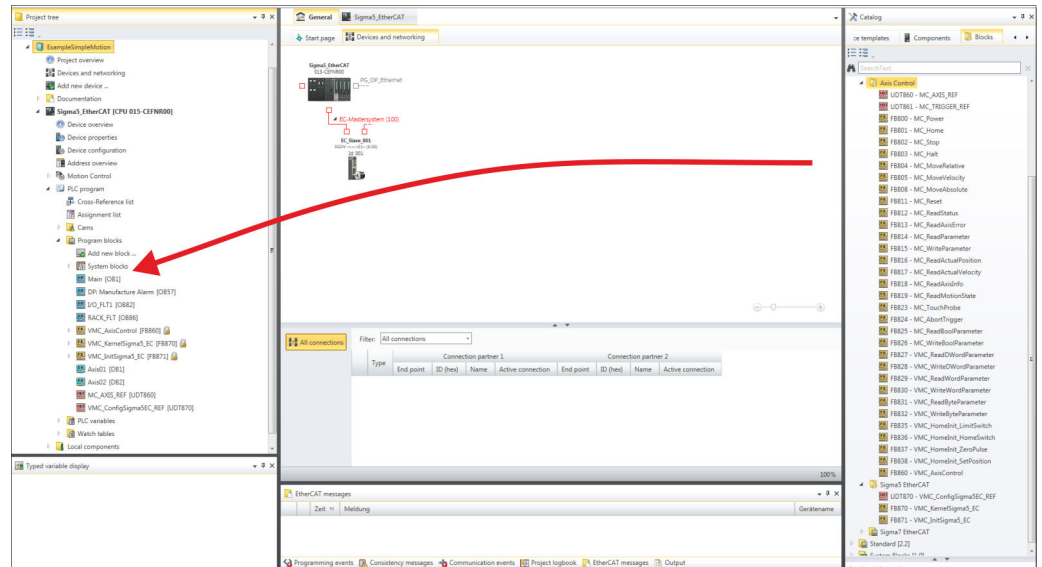

3. In the '*Catalog*', open the '*Simple Motion Control*' library at '*Blocks*' and drag and drop the following blocks into '*Program blocks*' of the *Project tree*:

- *Sigma-5 EtherCAT*:
 - UDT 870 - VMC_ConfigSigma5EC_REF
 - FB 870 - VMC_KernelSigma5_EC
 - FB 871 - VMC_InitSigma5_EC
- *Axis Control*
 - UDT 860 - MC_AXIS_REF
 - Blocks for your movement sequences

Create axis DB

1. Add a new DB as your *axis DB* to your project. Click in the *Project tree* within the CPU at '*PLC program*', '*Program blocks*' at '*Add New block*', select the block type '*DB block*' and assign the name "Axis01" to it. The DB number can freely be selected such as DB 10.

⇒ The block is created and opened.

2. ➔ ■ In "Axis01", create the variable "Config" of type UDT 870. These are specific axis configuration data.
- In "Axis01", create the variable "Axis" of type UDT 860. During operation, all operating data of the axis are stored here.

Axis01 [DB10]
Data block structure

	Adr...	Name	Data type	...
	...	Config	UDT	[870]
	...	Axis	UDT	[860]

OB 1

Configuration of the axis

Open OB 1 and program the following FB calls with associated DBs:

- ➔ FB 871 - VMC_InitSigma5_EC, DB 871 ↪ *Chap. 13.2.1.5.3 'FB 871 - VMC_InitSigma5_EC - Sigma-5 EtherCAT initialization' page 322*

At *InputsStartAddressPDO* respectively *OutputsStartAddressPDO*, enter the address from the *SPEED7 EtherCAT Manager*. ↪ 299

```

⇒ CALL "VMC_InitSigma5_EC" , "DI_InitSgm5ETC01"
   Enable           := "InitS5EC1_Enable"
   LogicalAddress   := 300
   InputsStartAddressPDO := 300 (EtherCAT-Man.:S7 Input address)
   OutputsStartAddressPDO := 300 (EtherCAT-Man.:S7 Output address)
   EncoderType      := 1
   EncoderResolutionBits := 20
   FactorPosition   := 1.048576e+006
   FactorVelocity   := 1.048576e+006
   FactorAcceleration := 1.048576e+002
   OffsetPosition   := 0.000000e+000
   MaxVelocityApp   := 5.000000e+001
   MaxAccelerationApp := 1.000000e+002
   MaxDecelerationApp := 1.000000e+002
   MaxVelocityDrive := 6.000000e+001
   MaxAccelerationDrive := 1.500000e+002
   MaxDecelerationDrive := 1.500000e+002
   MaxPosition      := 1.048500e+003
   MinPosition      := -1.048514e+003
   EnableMaxPosition := TRUE
   EnableMinPosition := TRUE
   MinUserPosition   := "InitS5EC1_MinUserPos"
   MaxUserPosition   := "InitS5EC1_MaxUserPos"
   Valid             := "InitS5EC1_Valid"
   Error             := "InitS5EC1_Error"
   ErrorID           := "InitS5EC1_ErrorID"
   Config            := "Axis01".Config
   Axis              := "Axis01".Axis

```

Connecting the Kernel for the axis

The *Kernel* processes the user commands and passes them appropriately processed on to the drive via the respective bus system.

- ➔ FB 870 - VMC_KernelSigma5_EC, DB 870 ↪ *Chap. 13.2.1.5.2 'FB 870 - VMC_KernelSigma5_EC - Sigma-5 EtherCAT Kernel' page 322*

```

⇒ CALL "VMC_KernelSigma5_EC" , "DI_KernelSgm5ETC01"
   Init := "KernelS5EC1_Init"
   Config := "Axis01".Config
   Axis := "Axis01".Axis

```

Connecting the block for motion sequences

For simplicity, the connection of the FB 860 - VMC_AxisControl is to be shown here. This universal block supports simple motion commands and returns status messages. The inputs and outputs can be individually connected. Please specify the reference to the corresponding axis data at 'Axis' in the axis DB.

→ FB 860 - VMC_AxisControl, DB 860 ↪ *Chap. 13.7.2.2 'FB 860 - VMC_AxisControl - Control block axis control' page 544*

```
⇒ CALL "VMC_AxisControl" , "DI_AxisControl01"
   AxisEnable      := "AxCtrl1_AxisEnable"
   AxisReset       := "AxCtrl1_AxisReset"
   HomeExecute     := "AxCtrl1_HomeExecute"
   HomePosition    := "AxCtrl1_HomePosition"
   StopExecute     := "AxCtrl1_StopExecute"
   MvVelocityExecute := "AxCtrl1_MvVelExecute"
   MvRelativeExecute := "AxCtrl1_MvRelExecute"
   MvAbsoluteExecute := "AxCtrl1_MvAbsExecute"
   PositionDistance := "AxCtrl1_PositionDistance"
   Velocity        := "AxCtrl1_Velocity"
   Acceleration    := "AxCtrl1_Acceleration"
   Deceleration    := "AxCtrl1_Deceleration"
   JogPositive     := "AxCtrl1_JogPositive"
   JogNegative     := "AxCtrl1_JogNegative"
   JogVelocity     := "AxCtrl1_JogVelocity"
   JogAcceleration := "AxCtrl1_JogAcceleration"
   JogDeceleration := "AxCtrl1_JogDeceleration"
   AxisReady       := "AxCtrl1_AxisReady"
   AxisEnabled     := "AxCtrl1_AxisEnabled"
   AxisError       := "AxCtrl1_AxisError"
   AxisErrorID     := "AxCtrl1_AxisErrorID"
   DriveWarning    := "AxCtrl1_DriveWarning"
   DriveError      := "AxCtrl1_DriveError"
   DriveErrorID    := "AxCtrl1_DriveErrorID"
   IsHomed         := "AxCtrl1_IsHomed"
   ModeOfOperation := "AxCtrl1_ModeOfOperation"
   PLCOpenState    := "AxCtrl1_PLCOpenState"
   ActualPosition  := "AxCtrl1_ActualPosition"
   ActualVelocity  := "AxCtrl1_ActualVelocity"
   CmdDone         := "AxCtrl1_CmdDone"
   CmdBusy         := "AxCtrl1_CmdBusy"
   CmdAborted      := "AxCtrl1_CmdAborted"
   CmdError        := "AxCtrl1_CmdError"
   CmdErrorID     := "AxCtrl1_CmdErrorID"
   DirectionPositive := "AxCtrl1_DirectionPos"
   DirectionNegative := "AxCtrl1_DirectionNeg"
   SWLimitMinActive := "AxCtrl1_SWLimitMinActive"
   SWLimitMaxActive := "AxCtrl1_SWLimitMaxActive"
   HWLimitMinActive := "AxCtrl1_HWLimitMinActive"
   HWLimitMaxActive := "AxCtrl1_HWLimitMaxActive"
   Axis            := "Axis01".Axis
```



For complex motion tasks, you can use the PLCOpen blocks. Please specify the reference to the corresponding axis data at Axis in the axis DB.

Your project now includes the following blocks:

- OB 1 - Main
- OB 57 - DP Manufacturer Alarm
- OB 82 - I/O_FLT1
- OB 86 - Rack_FLT
- FB 860 - VMC_AxisControl with instance DB

- FB 870 - VMC_KernelSigma5_EC with instance DB
- FB 871 - VMC_InitSigma5_EC with instance DB
- UDT 860 - MC_Axis_REF
- UDT 870 - VMC_ConfigSigma5EC_REF

Sequence of operations

1. ➤ Select *'Project → Compile all'* and transfer the project into your CPU. You can find more information on the transfer of your project in the online help of the *SPEED7 Studio*.

⇒ You can take your application into operation now.



CAUTION!

Please always observe the safety instructions for your drive, especially during commissioning!

2. ➤ Before an axis can be controlled, it must be initialized. To do this, call the *Init* block FB 871 - VMC_InitSigma5_EC with *Enable* = TRUE.

⇒ The output *Valid* returns TRUE. In the event of a fault, you can determine the error by evaluating the *ErrorID*.

You have to call the *Init* block again if you load a new axis DB or you have changed parameters on the *Init* block.



Do not continue until the Init block does not report any errors!

3. ➤ Ensure that the *Kernel* block FB 870 - VMC_KernelSigma5_EC is cyclically called. In this way, control signals are transmitted to the drive and status messages are reported.
4. ➤ Program your application with the FB 860 - VMC_AxisControl or with the PLCopen blocks.

Controlling the drive via HMI

There is the possibility to control your drive via HMI. For this, a predefined symbol library is available for Movicon to access the VMC_AxisControl function block. ↪ *Chap. 13.8 'Controlling the drive via HMI' page 613*

13.2.1.4 Usage in Siemens SIMATIC Manager







13.2.1.4.1 Precondition

Overview

- Please use for configuration the Siemens SIMATIC Manager V 5.5 SP2 and up.
- The configuration of the System SLIO CPU happens in the Siemens SIMATIC Manager by means of a virtual PROFINET IO device *'VIPA SLIO CPU'*. The *'VIPA SLIO CPU'* is to be installed in the hardware catalog by means of the GSDML.
- The configuration of the EtherCAT masters happens in the Siemens SIMATIC Manager by means of a virtual PROFINET IO device *'EtherCAT network'*. The *'EtherCAT network'* is to be installed in the hardware catalog by means of the GSDML.
- The *'EtherCAT network'* can be configured with the VIPA Tool *SPEED7 EtherCAT Manager*.
- For the configuration of the drive in the *SPEED7 EtherCAT Manager* the installation of the according ESI file is necessary.







**Installing the IO device
'VIPA SLIO System'**

The installation of the PROFINET IO device 'VIPA SLIO CPU' happens in the hardware catalog with the following approach:

1.  Go to the service area of www.vipa.com.
2.  Download the configuration file for your CPU from the download area via 'Config files → PROFINET'.
3.  Extract the file into your working directory.
4.  Start the Siemens hardware configurator.
5.  Close all the projects.
6.  Select 'Options → Install new GSD file'.
7.  Navigate to your working directory and install the according GSDML file.
 - ⇒ After the installation the according PROFINET IO device can be found at 'PROFINET IO → Additional field devices → I/O → VIPA SLIO System'.

**Installing the IO device
EtherCAT network**









The installation of the PROFINET IO devices 'EtherCAT Network' happens in the hardware catalog with the following approach:

1.  Go to the service area of www.vipa.com
2.  Load from the download area at 'Config files → EtherCAT' the GSDML file for your EtherCAT master.
3.  Extract the files into your working directory.
4.  Start the Siemens hardware configurator.
5.  Close all the projects.
6.  Select 'Options → Install new GSD file'.
7.  Navigate to your working directory and install the according GSDML file.
 - ⇒ After the installation the 'EtherCAT Network' can be found at 'PROFINET IO → Additional field devices → I/O → VIPA VIPA EtherCAT System'.

**Installing the SPEED7
EtherCAT Manager**

The configuration of the PROFINET IO device 'EtherCAT Network' happens by means of the *SPEED7 EtherCAT Manager* from VIPA. This may be found in the service area of www.vipa.com at 'Service/Support → Downloads → Software'.

The installation happens with the following proceeding:

1.  Close the Siemens SIMATIC Manager.
2.  Go to the service area of www.vipa.com
3.  Load the *SPEED7 EtherCAT Manager* and unzip it on your PC.
4.  For installation start the file *EtherCATManager_v... .exe*.
5.  Select the language for the installation.
6.  Accept the licensing agreement.
7.  Select the installation directory and start the installation.
8.  After installation you have to reboot your PC.
 - ⇒ The *SPEED7 EtherCAT Manager* is installed and can now be called via the context menu of the Siemens SIMATIC Manager.

13.2.1.4.2 Hardware configuration

Configuring the CPU in the project

Slot	Module
1	
2	CPU 315-2 PN/DP
X1	MPI/DP
X2	PN-IO
X2...	Port 1
X2...	Port 2
3	

To be compatible with the Siemens SIMATIC Manager the following steps should be executed:

1. Start the Siemens hardware configurator with a new project.
2. Insert a profile rail from the hardware catalog.
3. Place at 'Slot' number 2 the CPU 315-2 PN/DP (315-2EH14 V3.2).
4. The integrated PROFIBUS DP master (jack X3) is to be configured and connected via the sub module 'X1 MPI/DP'.
5. The integrated EtherCAT master is to be configured via the sub module 'X2 PN-IO' as a virtual PROFINET network.
6. Click at the sub module 'PN-IO' of the CPU.
7. Select 'Context menu → Insert PROFINET IO System'.

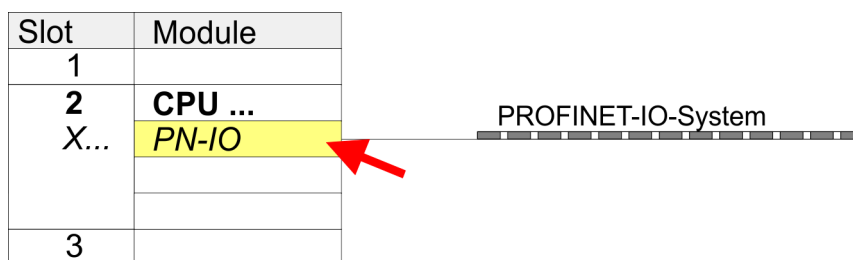

8. Create with [New] a new sub net and assign valid address data
9. Click at the sub module 'PN-IO' of the CPU and open with 'Context menu → Properties' the properties dialog.
10. Enter at 'General' a 'Device name'. The device name must be unique at the Ethernet subnet.

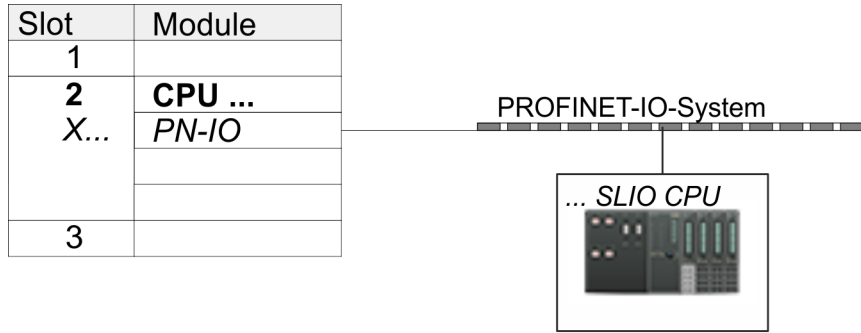

Slot	Module	Order number
0	... SLIO CPU ...	015-...
X2	015-...	
1		
2		
3		
...		

11. Navigate in the hardware catalog to the directory '*PROFINET IO*' → '*Additional field devices*' → '*I/O*' → '*VIPA SLIO System*' and connect the IO device '*015-CFFNR00 CPU*' to your PROFINET system.

⇒ In the Device overview of the PROFINET IO device '*VIPA SLIO CPU*' the CPU is already placed at slot 0. From slot 1 you can place your System SLIO modules.

Configuration of Ethernet PG/OP channel

Slot	Module
1	
2	CPU ...
X...	<i>PN-IO</i>
3	
4	343-1EX30
5	
...	

1. Place for the Ethernet PG/OP channel at slot 4 the Siemens CP 343-1 (SIMATIC 300 \ CP 300 \ Industrial Ethernet \ CP 343-1 \ 6GK7 343-1EX30 0XE0 V3.0).
2. Open the properties dialog by clicking on the CP 343-1EX30 and enter for the CP at '*Properties*' the IP address data. You get valid IP address parameters from your system administrator.
3. Assign the CP to a '*Subnet*'. The IP address data are not accepted without assignment!

Insert 'EtherCAT network'

Slot	Module
1	
2	CPU ...
X...	<i>PN-IO</i>
3	

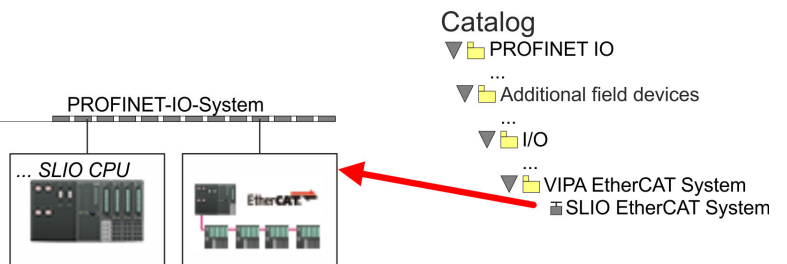

1. Navigate in the hardware catalog to the directory '*PROFINET IO*' → '*Additional field devices*' → '*I/O*' → '*VIPA EtherCAT System*' and connect the IO device '*SLIO EtherCAT System*' to your PROFINET system.

- Click at the inserted IO device 'EtherCAT Network' and define the areas for in and output by drag and dropping the according 'Out' or 'In' area to a slot.

Create the following areas:

- In 128byte
- Out 128byte

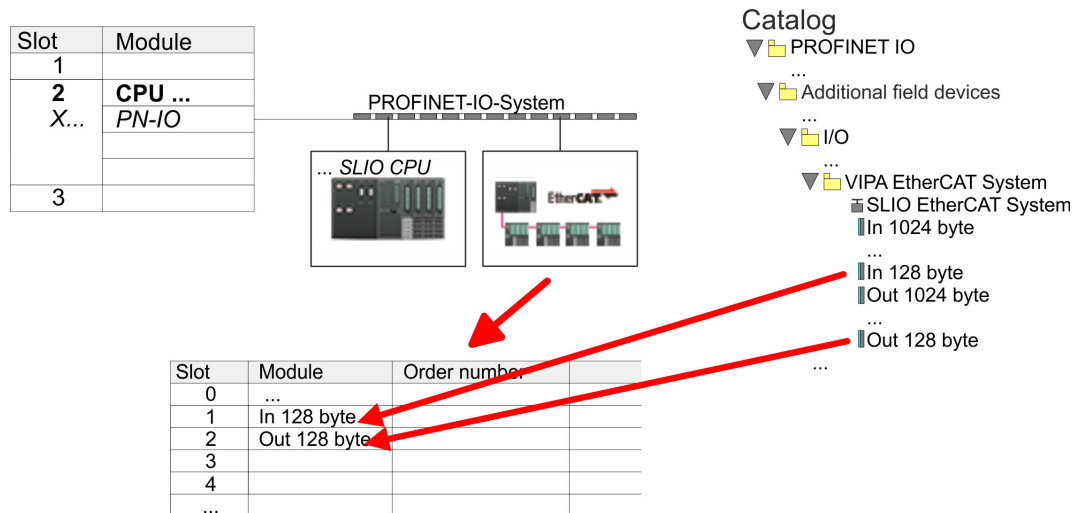

- Select 'Station → Save and compile'

Sigma-5 Configure EtherCAT drive

The drive is configured in the *SPEED7 EtherCAT Manager*.



Before calling the *SPEED7 EtherCAT Manager* you have always to save your project with 'Station → Save and compile'.

Slot	Module
1	
2	CPU ...
X...	PN-IO
3	

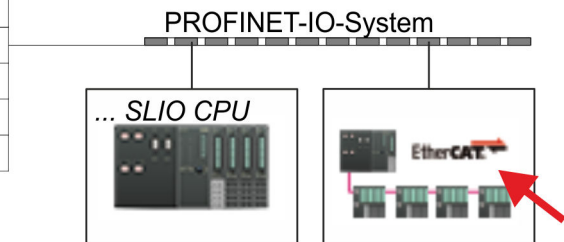

1. Click at an inserted IO device 'EtherCAT Network' and select 'Context menu → Start Device-Tool → SPEED7 EtherCAT Manager'.
 - ⇒ The *SPEED7 EtherCAT Manager* opens. Here you can configure the EtherCAT communication to your *Sigma-5* drive.

More information about the usage of the *SPEED7 EtherCAT Manager* may be found in the according manual or online help.

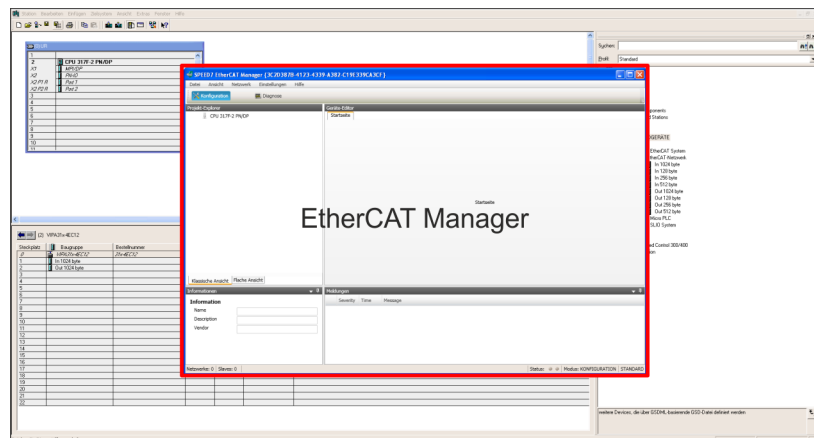

3. For the *Sigma-5* EtherCAT drive to be configured in the *SPEED7 EtherCAT Manager*, the corresponding ESI file must be installed. The ESI file for the *Sigma-5* EtherCAT drive can be found under www.yaskawa.eu.com at 'Service → Drives & Motion Software'. Download the according ESI file for your drive. Unzip this if necessary.
4. Open in the *SPEED7 EtherCAT Manager* via 'File → ESI Manager' the dialogue window 'ESI Manager'.
5. In the 'ESI Manager' click at [Add File] and select your ESI file. With [Open], the ESI file is installed in the *SPEED7 EtherCAT Manager*.
6. Close the 'ESI Manager'.
 - ⇒ Your *Sigma-5* EtherCAT drive is now available for configuration.

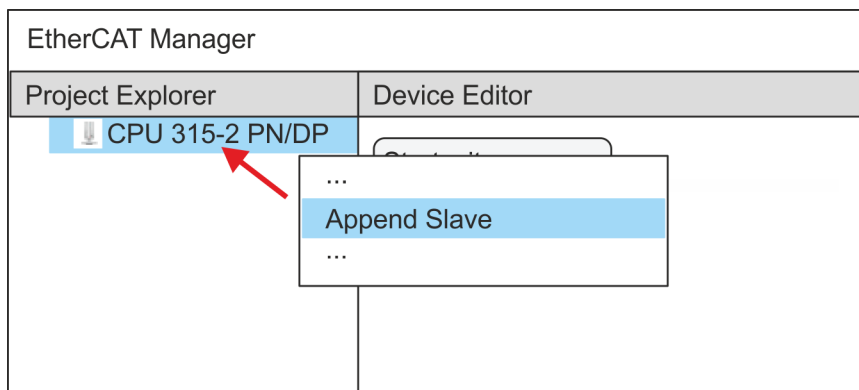

7. In the EtherCAT Manager, click on your CPU and open via 'Context menu' → 'Append Slave' the dialog box for adding an EtherCAT slave.
 - ⇒ The dialog window for selecting an EtherCAT slave is opened.
8. Select your *Sigma-5* EtherCAT drive and confirm your selection with [OK].
 - ⇒ The *Sigma-5* EtherCAT drive is connected to the master and can now be configured.

9.



You can only edit PDOs in 'Expert mode'! Otherwise, the buttons are hidden. By activating the 'Expert mode' you can switch to advanced setting.

By activating 'View → Expert' you can switch to the *Expert mode*.

10. Click on the *Sigma-5* EtherCAT Slave in the *SPEED7 EtherCAT Manager* and select the 'PDO assign' tab in the 'Device editor'.

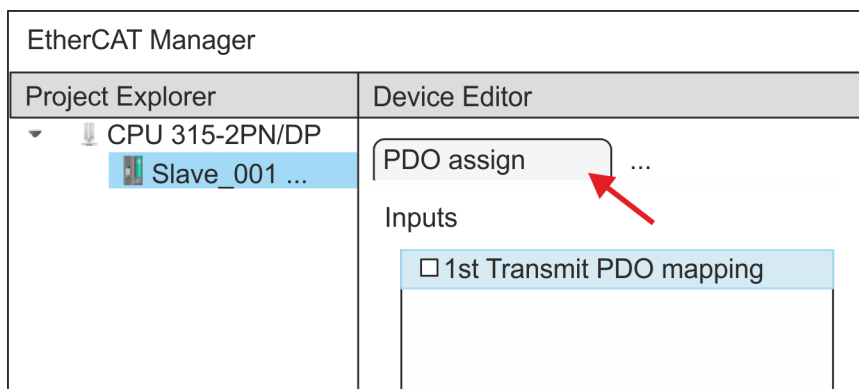

⇒ This dialog shows a list of the PDOs.

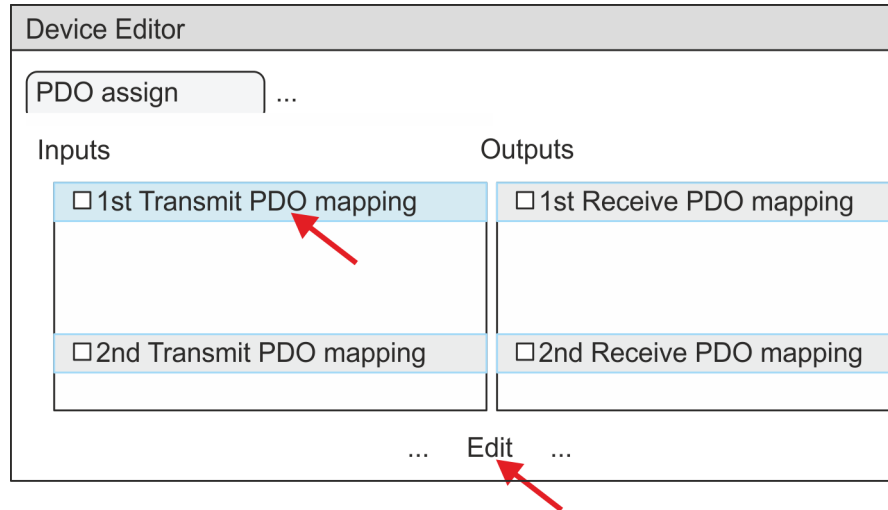

11. By selecting the appropriate PDO mapping, you can edit the PDOs with [Edit]. Select the mapping '1st Transmit PDO mapping' and click at [Edit].



Please note that some PDOs can not be edited because of the default settings. By de-activating already activated PDOs, you can release the processing of locked PDOs.

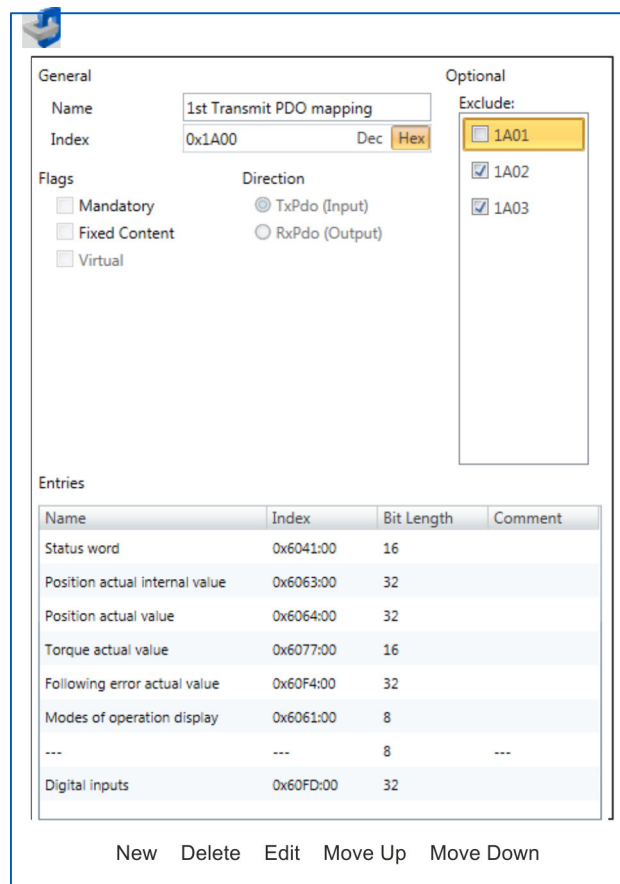

- ⇒ The dialog 'Edit PDO' is opened. Please check the PDO settings listed here and adjust them if necessary. Please also take into account the order of the 'Entries' and add them accordingly.

The following functions are available for editing the 'Entries':

- New
 - Here you can create a new entry in a dialog by selecting the corresponding entry from the 'CoE object dictionary' and making your settings. The entry is accepted with [OK] and is listed in the list of entries.
- Delete
 - This allows you to delete a selected entry.
- Edit
 - This allows you to edit the general data of an entry.
- Move Up/Down
 - This allows you to move the selected entry up or down in the list.

12. Perform the following settings:

Inputs: 1st Transmit PDO 0x1A00

- General
 - Name: 1st Transmit PDO mapping
 - Index: 0x1A00
- Flags
 - Everything de-activated
- Direction
 - TxPdo (Input): activated
- Exclude

Please note these settings, otherwise the PDO mappings can not be activated at the same time!

 - 1A01: de-activated
- Entries

Name	Index	Bit length
Status word	0x6041:00	16bit
Position actual internal value	0x6063:00	32bit
Position actual value	0x6064:00	32bit
Torque actual value	0x6077:00	16bit
Following error actual value	0x60F4:00	32bit
Modes of operation display	0x6061:00	8bit
---	---	8bit
Digital inputs	0x60FD:00	32bit

Close the dialog 'Edit PDO' with [OK].

- 13.** Select the mapping '2nd Transmit PDO mapping' and click at [Edit]. Perform the following settings:

Inputs: 2nd Transmit PDO 0x1A01

- General
 - Name: 2nd Transmit PDO mapping
 - Index: 0x1A01
- Flags
 - Everything de-activated
- Direction
 - TxPdo (Input): activated
- Exclude

Please note these settings, otherwise the PDO mappings can not be activated at the same time!

- 1A00: de-activated
- 1A02: de-activated
- 1A03: de-activated
- Entries

Name	Index	Bit length
Touch probe status	0x60B9:00	16bit
Touch probe 1 position value	0x60BA:00	32bit
Touch probe 2 position value	0x60BC:00	32bit
Velocity actual value	0x606C:00	32bit

Close the dialog 'Edit PDO' with [OK].

- 14.** Select the mapping '1st Receive PDO mapping' and click at [Edit]. Perform the following settings:

Outputs: 1st Receive PDO 0x1600

- General
 - Name: 1st Receive PDO mapping
 - Index: 0x1600
- Flags
 - Everything de-activated
- Direction
 - RxPdo (Output): activated
- Exclude

Please note these settings, otherwise the PDO mappings can not be activated at the same time!

- 1601: de-activated
- 1602: de-activated
- 1603: de-activated
- Entries

Name	Index	Bit length
Control word	0x6040:00	16bit
Target position	0x607A:00	32bit
Target velocity	0x60FF:00	32bit
Modes of operation	0x6060:00	8bit
---	---	8bit
Touch probe function	0x60B8:00	16bit

Close the dialog 'Edit PDO' with [OK].

15. Select the mapping '2nd Receive PDO mapping' and click at [Edit]. Perform the following settings:

Outputs: 2nd Receive PDO 0x1601

- General
 - Name: 2nd Receive PDO mapping
 - Index: 0x1601
- Flags
 - Everything de-activated
- Direction
 - RxPdo (Output): activated
- Exclude

Please note these settings, otherwise the PDO mappings can not be activated at the same time!

- 1600: de-activated
- 1602: activated
- 1603: activated
- Entries

Name	Index	Bit length
Profile velocity	0x6081:00	32bit
Profile acceleration	0x6083:00	32bit
Profile deceleration	0x6084:00	32bit

Close the dialog 'Edit PDO' with [OK].

16. In PDO assignment, activate the PDOs 1 and 2 for the inputs and outputs. All subsequent PDOs must remain de-activated. If this is not possible, please check the respective PDO parameter 'Exclude'.

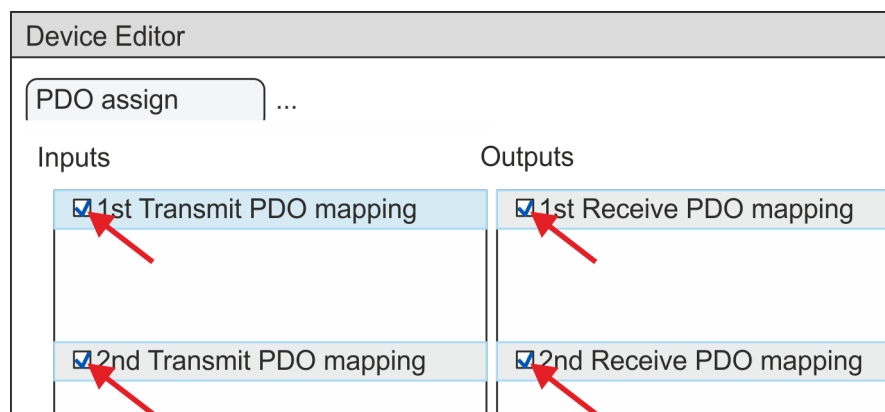

17. In the 'Device Editor' of the SPEED7 EtherCAT Manager, select the 'Distributed clocks' tab and set 'DC unused' as 'Operating mode'.

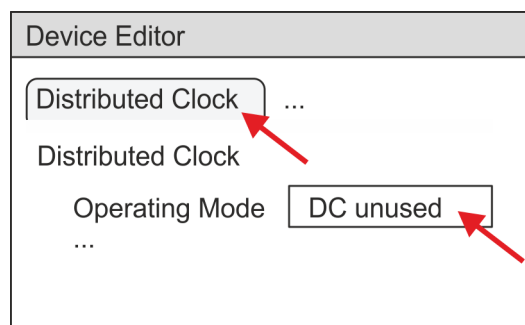

18. Select the 'Process image' tab via the arrow key in the 'Device editor' and note for the parameter of the block FB 871 - VMC_InitSigma5_EC the following PDO.
 - 'S7 Input address' → 'InputsStartAddressPDO'
 - 'S7 Output address' → 'OutputsStartAddressPDO'

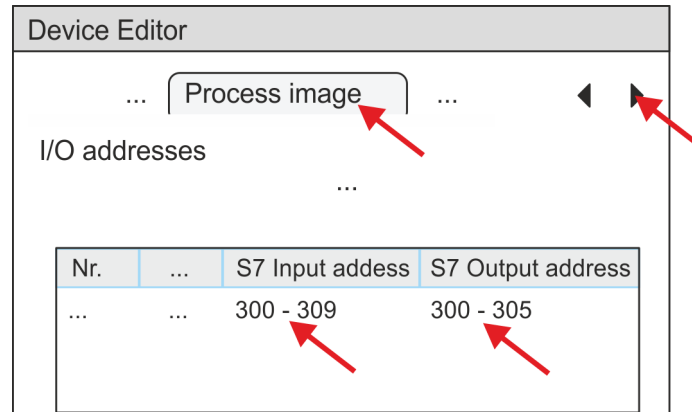

19. By closing the *SPEED7 EtherCAT Manager* with [X] the configuration is taken to the project. You can always edit your EtherCAT configuration in the *SPEED7 EtherCAT Manager*, since the configuration is stored in your project.
20. Save and compile your configuration

13.2.1.4.3 User program

Program structure

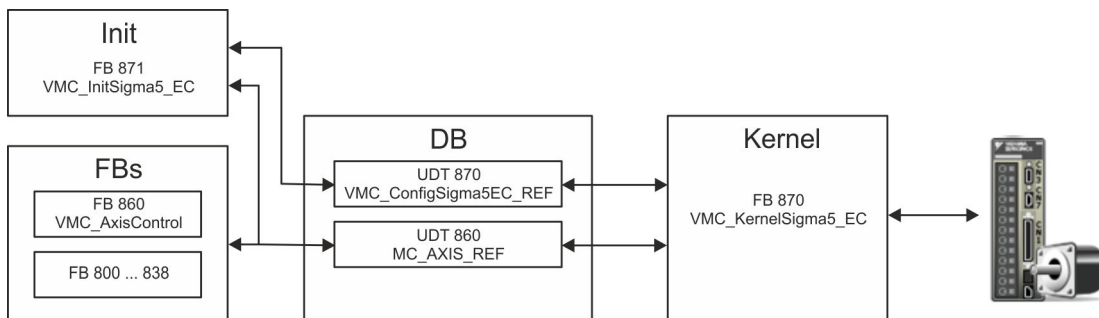

- DB
 - A data block (axis DB) for configuration and status data must be created for each axis of a drive. The data block consists of the following data structures:
 - UDT 870 - *VMC_ConfigSigma5EC_REF*
The data structure describes the structure of the configuration of the drive. Specific data structure for *Sigma-5* EtherCAT.
 - UDT 860 - *MC_AXIS_REF*
The data structure describes the structure of the parameters and status information of drives.
General data structure for all drives and bus systems.
- FB 871 - *VMC_InitSigma5_EC*
 - The *Init* block is used to configure an axis.
 - Specific block for *Sigma-5* EtherCAT.
 - The configuration data for the initialization must be stored in the *axis DB*.

- FB 870 - *VMC_KerneSigma5_EC*
 - The *Kernel* block communicates with the drive via the appropriate bus system, processes the user requests and returns status messages.
 - Specific block for *Sigma-5* EtherCAT.
 - The exchange of the data takes place by means of the *axis DB*.
- FB 860 - *VMC_AxisControl*
 - General block for all drives and bus systems.
 - Supports simple motion commands and returns all relevant status messages.
 - The exchange of the data takes place by means of the *axis DB*.
 - For motion control and status query, via the instance data of the block you can link a visualization.
 - In addition to the FB 860 - *VMC_AxisControl*, *PLCopen* blocks can be used.
- FB 800 ... FB 838 - *PLCopen*
 - The *PLCopen* blocks are used to program motion sequences and status queries.
 - General blocks for all drives and bus systems.

Programming

Include library

1. ➤ Go to the service area of www.vipa.com.
2. ➤ Download the *Simple Motion Control* library from the download area at '*VIPA Lib*'.
3. ➤ Open the dialog window for ZIP file selection via '*File* ➔ *Retrieve*'.
4. ➤ Select the according ZIP file and click at [Open].
5. ➤ Specify a target directory in which the blocks are to be stored and start the unzip process with [OK].

Copy blocks into project

- Open the library after unzipping and drag and drop the following blocks into '*Blocks*' of your project:
 - *Sigma-5* EtherCAT:
 - UDT 870 - *VMC_ConfigSigma5EC_REF*
 - FB 870 - *VMC_KernelSigma5_EC*
 - FB 871 - *VMC_InitSigma5_EC*
 - *Axis Control*
 - UDT 860 - *MC_AXIS_REF*
 - Blocks for your movement sequences

Create interrupt OBs

1. ➤ In your project, click at '*Blocks*' and choose '*Context menu* ➔ *Insert new object* ➔ *Organization block*'.
 - ⇒ The dialog '*Properties Organization block*' opens.
2. ➤ Add OB 57, OB 82, and OB 86 successively to your project.

Create axis DB

1. In your project, click at 'Blocks' and choose 'Context menu → Insert new object → Data block'.

Specify the following parameters:

- Name and type
 - The DB no. as 'Name' can freely be chosen, such as DB 10.
 - Set 'Shared DB' as the 'Type'.
- Symbolic name
 - Specify "Axis01".

Confirm your input with [OK].

⇒ The block is created.

2. Open DB 10 "Axis01" by double-click.
 - In "Axis01", create the variable "Config" of type UDT 870. These are specific axis configuration data.
 - In "Axis01", create the variable "Axis" of type UDT 860. During operation, all operating data of the axis are stored here.

DB10

Address	Name	Typ	...
		Struct	
...	Config	"VMC_ConfigSigma5EC_REF"	
...	Axis	"MC_AXIS_REF"	
...		END_STRUCT	

OB 1**Configuration of the axis**

Open OB 1 and program the following FB calls with associated DBs:

→ FB 871 - VMC_InitSigma5_EC, DB 871 ↪ *Chap. 13.2.1.5.3 'FB 871 - VMC_InitSigma5_EC - Sigma-5 EtherCAT initialization' page 322*

At *InputsStartAddressPDO* respectively *OutputsStartAddressPDO*, enter the address from the *SPEED7 EtherCAT Manager*. ↪ 315

```
⇒ CALL "VMC_InitSigma5_EC" , "DI_InitSgm5ETC01"
   Enable           := "InitS5EC1_Enable"
   LogicalAddress   := 300
   InputsStartAddressPDO := 300 (EtherCAT-Man.: S7 Input
   address)
   OutputsStartAddressPDO := 300 (EtherCAT-Man.: S7 Output
   address)
   EncoderType      := 1
   EncoderResolutionBits := 20
   FactorPosition   := 1.048576e+006
   FactorVelocity   := 1.048576e+006
   FactorAcceleration := 1.048576e+002
   OffsetPosition   := 0.000000e+000
   MaxVelocityApp   := 5.000000e+001
   MaxAccelerationApp := 1.000000e+002
   MaxDecelerationApp := 1.000000e+002
   MaxVelocityDrive := 6.000000e+001
   MaxAccelerationDrive := 1.500000e+002
   MaxDecelerationDrive := 1.500000e+002
   MaxPosition      := 1.048500e+003
   MinPosition      := -1.048514e+003
   EnableMaxPosition := TRUE
   EnableMinPosition := TRUE
   MinUserPosition   := "InitS5EC1_MinUserPos"
   MaxUserPosition   := "InitS5EC1_MaxUserPos"
   Valid             := "InitS5EC1_Valid"
   Error             := "InitS5EC1_Error"
   ErrorID           := "InitS5EC1_ErrorID"
   Config            := "Axis01".Config
   Axis              := "Axis01".Axis
```

Connecting the Kernel for the axis

The *Kernel* processes the user commands and passes them appropriately processed on to the drive via the respective bus system.

→ FB 870 - VMC_KernelSigma5_EC, DB 870 ↪ *Chap. 13.2.1.5.2 'FB 870 - VMC_KernelSigma5_EC - Sigma-5 EtherCAT Kernel' page 322*

```
⇒ CALL "VMC_KernelSigma5_EC" , "DI_KernelSgm5ETC01"
   Init := "KernelS5EC1_Init"
   Config := "Axis01".Config
   Axis := "Axis01".Axis
```

Connecting the block for motion sequences

For simplicity, the connection of the FB 860 - VMC_AxisControl is to be shown here. This universal block supports simple motion commands and returns status messages. The inputs and outputs can be individually connected. Please specify the reference to the corresponding axis data at 'Axis' in the axis DB.

→ FB 860 - VMC_AxisControl, DB 860 ↪ *Chap. 13.7.2.2 'FB 860 - VMC_AxisControl - Control block axis control' page 544*

```
⇒ CALL "VMC_AxisControl" , "DI_AxisControl01"
   AxisEnable      := "AxCtrl1_AxisEnable"
   AxisReset       := "AxCtrl1_AxisReset"
   HomeExecute     := "AxCtrl1_HomeExecute"
   HomePosition    := "AxCtrl1_HomePosition"
   StopExecute     := "AxCtrl1_StopExecute"
   MvVelocityExecute := "AxCtrl1_MvVelExecute"
   MvRelativeExecute := "AxCtrl1_MvRelExecute"
   MvAbsoluteExecute := "AxCtrl1_MvAbsExecute"
   PositionDistance := "AxCtrl1_PositionDistance"
   Velocity        := "AxCtrl1_Velocity"
   Acceleration    := "AxCtrl1_Acceleration"
   Deceleration    := "AxCtrl1_Deceleration"
   JogPositive     := "AxCtrl1_JogPositive"
   JogNegative     := "AxCtrl1_JogNegative"
   JogVelocity     := "AxCtrl1_JogVelocity"
   JogAcceleration := "AxCtrl1_JogAcceleration"
   JogDeceleration := "AxCtrl1_JogDeceleration"
   AxisReady      := "AxCtrl1_AxisReady"
   AxisEnabled     := "AxCtrl1_AxisEnabled"
   AxisError       := "AxCtrl1_AxisError"
   AxisErrorID     := "AxCtrl1_AxisErrorID"
   DriveWarning    := "AxCtrl1_DriveWarning"
   DriveError      := "AxCtrl1_DriveError"
   DriveErrorID    := "AxCtrl1_DriveErrorID"
   IsHomed         := "AxCtrl1_IsHomed"
   ModeOfOperation := "AxCtrl1_ModeOfOperation"
   PLCOpenState    := "AxCtrl1_PLCOpenState"
   ActualPosition  := "AxCtrl1_ActualPosition"
   ActualVelocity  := "AxCtrl1_ActualVelocity"
   CmdDone         := "AxCtrl1_CmdDone"
   CmdBusy         := "AxCtrl1_CmdBusy"
   CmdAborted      := "AxCtrl1_CmdAborted"
   CmdError        := "AxCtrl1_CmdError"
   CmdErrorID      := "AxCtrl1_CmdErrorID"
   DirectionPositive := "AxCtrl1_DirectionPos"
   DirectionNegative := "AxCtrl1_DirectionNeg"
   SWLimitMinActive := "AxCtrl1_SWLimitMinActive"
   SWLimitMaxActive := "AxCtrl1_SWLimitMaxActive"
   HWLimitMinActive := "AxCtrl1_HWLimitMinActive"
   HWLimitMaxActive := "AxCtrl1_HWLimitMaxActive"
   Axis            := "Axis01".Axis
```



For complex motion tasks, you can use the PLCOpen blocks. Please specify the reference to the corresponding axis data at Axis in the axis DB.

Your project now includes the following blocks:

- OB 1 - Main
- OB 57 - DP Manufacturer Alarm
- OB 82 - I/O_FLT1
- OB 86 - Rack_FLT
- FB 860 - VMC_AxisControl with instance DB

- FB 870 - VMC_KernelSigma5_EC with instance DB
- FB 871 - VMC_InitSigma5_EC with instance DB
- UDT 860 - MC_Axis_REF
- UDT 870 - VMC_ConfigSigma5EC_REF

Sequence of operations

1. ➤ Choose the Siemens SIMATIC Manager and transfer your project into the CPU.
The transfer can only be done by the Siemens SIMATIC Manager - not hardware configurator!



Since slave and module parameters are transmitted by means of SDO respectively SDO Init command, the configuration remains active, until a power cycle is performed or new parameters for the same SDO objects are transferred.

With an overall reset the slave and module parameters are not reset!

⇒ You can take your application into operation now.



CAUTION!

Please always observe the safety instructions for your drive, especially during commissioning!

2. ➤ Before an axis can be controlled, it must be initialized. To do this, call the *Init* block FB 871 - VMC_InitSigma5_EC with *Enable* = TRUE.
 - ⇒ The output *Valid* returns TRUE. In the event of a fault, you can determine the error by evaluating the *ErrorID*.

You have to call the *Init* block again if you load a new axis DB or you have changed parameters on the *Init* block.



Do not continue until the Init block does not report any errors!

3. ➤ Ensure that the *Kernel* block FB 870 - VMC_KernelSigma5_EC is cyclically called. In this way, control signals are transmitted to the drive and status messages are reported.
4. ➤ Program your application with the FB 860 - VMC_AxisControl or with the PLCopen blocks.

Controlling the drive via HMI

There is the possibility to control your drive via HMI. For this, a predefined symbol library is available for Movicon to access the VMC_AxisControl function block. ↪ [Chap. 13.8 'Controlling the drive via HMI' page 613](#)

13.2.1.4.4 Copy project

Proceeding

In the example, the station 'Source' is copied and saved as 'Target'.

1. ➤ Open the hardware configuration of the 'Source' CPU and start the *SPEED7 EtherCAT Manager*.
2. ➤ In the *SPEED7 EtherCAT Manager*, via 'File → Save as' save the configuration in your working directory.

3. ➤ Close the *SPEED7 EtherCAT Manager* and the hardware configurator.
4. ➤ Copy the station 'Source' with Ctrl + C and paste it as 'Target' into your project with Ctrl + V.
5. ➤ Select the 'Blocks' directory of the 'Target' CPU and delete the 'System data'.
6. ➤ Open the hardware configuration of the 'Target' CPU. Adapt the IP address data or re-network the CPU or the CP again.



Before calling the SPEED7 EtherCAT Manager you have always to save your project with 'Station → Save and compile'.

7. ➤ Save your project with 'Station → Save and compile'.
8. ➤ Open the *SPEED7 EtherCAT Manager*.
9. ➤ Use 'File → Open' to load the configuration from your working directory.
10. ➤ Close the *SPEED7 EtherCAT Manager*.
11. ➤ Save and compile your configuration.

13.2.1.5 Drive specific blocks



The PLCopen blocks for axis control can be found here: [🔗 Chap. 13.7 'Blocks for axis control' page 542](#)

13.2.1.5.1 UDT 870 - VMC_ConfigSigma5EC_REF - Sigma-5 EtherCAT Data structure axis configuration

This is a user-defined data structure that contains information about the configuration data. The UDT is specially adapted to the use of a *Sigma-5* drive, which is connected via EtherCAT.

13.2.1.5.2 FB 870 - VMC_KernelSigma5_EC - Sigma-5 EtherCAT Kernel

Description

This block converts the drive commands for a *Sigma-5* axis via EtherCAT and communicates with the drive. For each *Sigma-5* axis, an instance of this FB is to be cyclically called.



Please note that this module calls the SFB 238 internally.

In the SPEED7 Studio, this module is automatically inserted into your project.

In Siemens SIMATIC Manager, you have to copy the SFB 238 from the Motion Control Library into your project.

Parameter	Declaration	Data type	Description
Init	INPUT	BOOL	The block is internally reset with an edge 0-1. Existing motion commands are aborted and the block is initialized.
Config	IN_OUT	UDT870	Data structure for transferring axis-dependent configuration data to the <i>AxisKernel</i> .
Axis	IN_OUT	MC_AXIS_REF	Data structure for transferring axis-dependent information to the <i>AxisKernel</i> and PLCopen blocks.

13.2.1.5.3 FB 871 - VMC_InitSigma5_EC - Sigma-5 EtherCAT initialization

Description

This block is used to configure the axis. The module is specially adapted to the use of a *Sigma-5* drive, which is connected via EtherCAT.

Parameter	Declaration	Data type	Description
Config	IN_OUT	UDT870	Data structure for transferring axis-dependent configuration data to the <i>AxisKernel</i> .
Axis	IN_OUT	MC_AXIS_REF	Data structure for transferring axis-dependent information to the <i>AxisKernel</i> and PLCopen blocks.
Enable	INPUT	BOOL	Release of initialization
Logical address	INPUT	INT	Start address of the PDO input data

Parameter	Declaration	Data type	Description
InputsStartAddressPDO	INPUT	INT	Start address of the input PDOs
OutputsStartAddressPDO	INPUT	INT	Start address of the output PDOs
EncoderType	INPUT	INT	Encoder type <ul style="list-style-type: none"> ■ 1: Absolute encoder ■ 2: Incremental encoder
EncoderResolutionBits	INPUT	INT	Number of bits corresponding to one encoder revolution. Default: 20
FactorPosition	INPUT	REAL	Factor for converting the position of user units [u] into drive units [increments] and back. It's valid: $p_{[\text{increments}]} = p_{[u]} \times \text{FactorPosition}$ Please consider the factor which can be specified on the drive via the objects 0x2701: 1 and 0x2701: 2. This should be 1.
Velocity Factor	INPUT	REAL	Factor for converting the speed of user units [u/s] into drive units [increments/s] and back. It's valid: $v_{[\text{increments/s}]} = v_{[u/s]} \times \text{FactorVelocity}$ Please also take into account the factor which you can specify on the drive via objects 0x2702: 1 and 0x2702: 2. This should be 1.
FactorAcceleration	INPUT	REAL	Factor to convert the acceleration of user units [u/s ²] in drive units [10 ⁻⁴ x increments/s ²] and back. It's valid: $10^{-4} \times a_{[\text{increments/s}^2]} = a_{[u/s^2]} \times \text{FactorAcceleration}$ Please also take into account the factor which you can specify on the drive via objects 0x2703: 1 and 0x2703: 2. This should be 1.
OffsetPosition	INPUT	REAL	Offset for the zero position [u].
MaxVelocityApp	INPUT	REAL	Maximum application speed [u/s]. The command inputs are checked to the maximum value before execution.
MaxAccelerationApp	INPUT	REAL	Maximum acceleration of the application [u/s ²]. The command inputs are checked to the maximum value before execution.
MaxDecelerationApp	INPUT	REAL	Maximum application deceleration [u/s ²]. The command inputs are checked to the maximum value before execution.
MaxPosition	INPUT	REAL	Maximum position for monitoring the software limits [u].
MinPosition	INPUT	REAL	Minimum position for monitoring the software limits [u].
EnableMaxPosition	INPUT	BOOL	Monitoring maximum position <ul style="list-style-type: none"> ■ TRUE: Activates the monitoring of the maximum position.
EnableMinPosition	INPUT	BOOL	Monitoring minimum position <ul style="list-style-type: none"> ■ TRUE: Activation of the monitoring of the minimum position.

Parameter	Declaration	Data type	Description
MinUserPosition	OUTPUT	REAL	Minimum user position based on the minimum encoder value of 0x80000000 and the <i>FactorPosition</i> [u].
MaxUserPosition	OUTPUT	REAL	Maximum user position based on the maximum encoder value of 0x7FFFFFFF and the <i>FactorPosition</i> [u].
Valid	OUTPUT	BOOL	Initialization <ul style="list-style-type: none"> ■ TRUE: Initialization is valid.
Error	OUTPUT	BOOL	<ul style="list-style-type: none"> ■ Error <ul style="list-style-type: none"> – TRUE: An error has occurred. Additional error information can be found in the parameter <i>ErrorID</i>. The axis is disabled.
ErrorID	OUTPUT	WORD	Additional error information ↗ Chap. 13.10 'ErrorID - Additional error information' page 637

13.2.2 Usage Sigma-7S EtherCAT

13.2.2.1 Overview

Usage of the double-axis drive [↗ Chap. 13.2.3 'Usage Sigma-7W EtherCAT' page 362](#)

Precondition

- SPEED7 Studio from V1.6.1
or
- Siemens SIMATIC Manager from V 5.5, SP2 & *SPEED7 EtherCAT Manager & Simple Motion Control Library*
- CPU with EtherCAT master, e.g. CPU 015-CEFNR00
- *Sigma-7S* drive with EtherCAT option card

Steps of configuration

1. [➤](#) Set the parameters on the drive
 - The setting of the parameters happens by means of the software tool *Sigma Win+*.
2. [➤](#) Hardware configuration in *VIPA SPEED7 Studio* or Siemens SIMATIC Manager
 - Configuring a CPU with EtherCAT master functionality.
 - Configuration of a *Sigma-7S* EtherCAT drive.
 - Configuring the EtherCAT connection via *SPEED7 EtherCAT Manager*.
3. [➤](#) Programming in *VIPA SPEED7 Studio* or Siemens SIMATIC Manager
 - Connecting the *Init* block to configure the axis.
 - Connecting the *Kernel* block to communicate with the axis.
 - Connecting the blocks for the motion sequences.

13.2.2.2 Set the parameters on the drive

Parameter digits

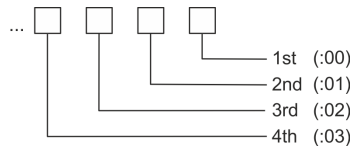
**CAUTION!**

Before the commissioning, you have to adapt your drive to your application with the *Sigma Win+* software tool! More may be found in the manual of your drive.

The following parameters must be set via *Sigma Win+* to match the *Simple Motion Control Library*:

Sigma-7S (24bit encoder)

Servopack Parameter	Address:digit	Name	Value
Pn205	(2205h)	Multiturn Limit Setting	65535
Pn20E	(220Eh)	ElectronicGear Ratio (Numerator)	16
Pn210	(2210h)	Electronic Gear Ratio (Denominator)	1
PnB02	(2701h:01)	Position User Unit (Numerator)	1
PnB04	(2701h:02)	Position User Unit (Denominator)	1
PnB06	(2702h:01)	Velocity User Unit (Numerator)	1
PnB08	(2702h:02)	Velocity User Unit (Denominator)	1
PnB0A	(2703h:01)	Acceleration User Unit (Numerator)	1
PnB0C	(2703h:02)	Acceleration User Unit (Denominator)	1

13.2.2.3 Usage in VIPA SPEED7 Studio

13.2.2.3.1 Hardware configuration

Add CPU in the project

Please use for configuration the *SPEED7 Studio* V1.6.1 and up.

1. Start the *SPEED7 Studio*.

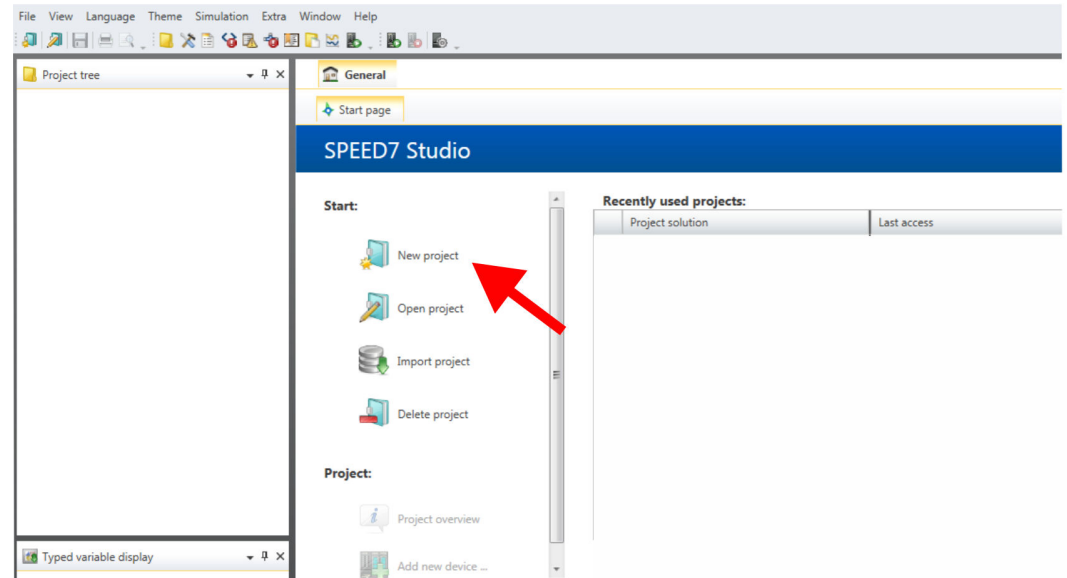

2. Create a new project at the start page with 'New project'.

⇒ A new project is created and the view 'Devices and networking' is shown.

3. Click in the *Project tree* at 'Add new device ...'.

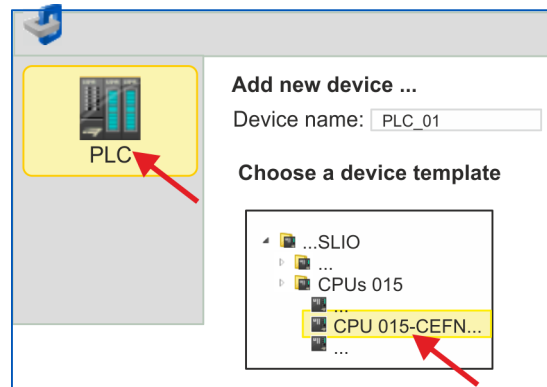
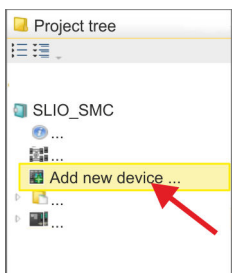

⇒ A dialog for device selection opens.

4. Select from the 'Device templates' a CPU with EtherCAT master functions such as CPU 015-CEFNR00 and click at [OK].

⇒ The CPU is inserted in 'Devices and networking' and the 'Device configuration' is opened.

Activate motion control functions

If the EtherCAT master functionality is not yet activated on your CPU, the activation takes place as follows:

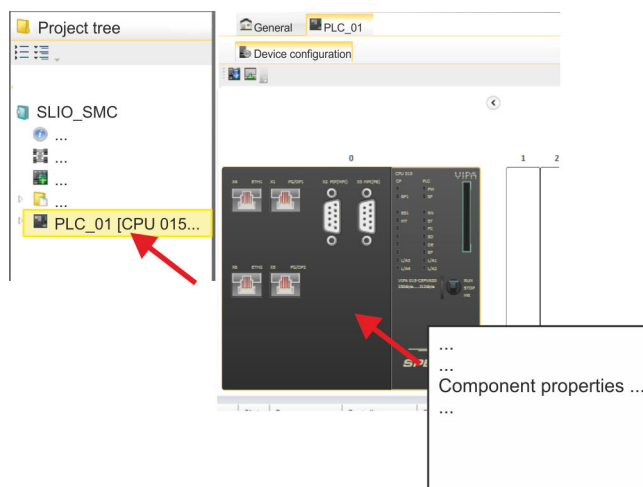

1. Click at the CPU in the 'Device configuration' and select 'Context menu' → 'Components properties'.

⇒ The properties dialog of the CPU is opened.

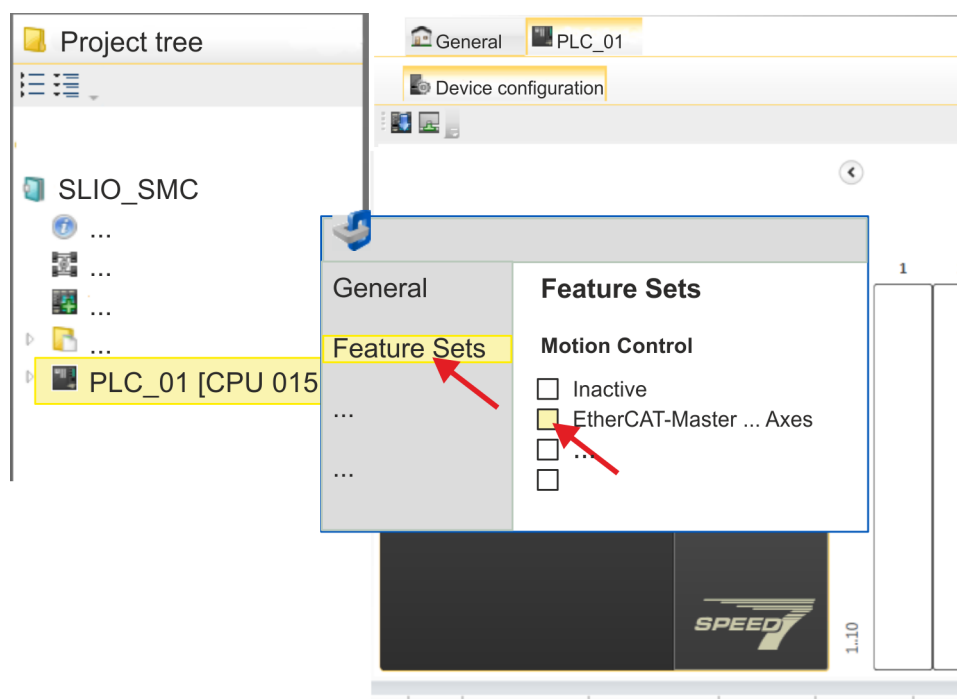

2. Click at 'Feature Sets' and activate at 'Motion Control' the parameter 'EtherCAT-Master... Axes'. The number of axes is not relevant in this example.

3. Confirm your input with [OK].

⇒ The motion control functions are now available in your project.



CAUTION!

Please note due to the system, with every change to the feature set settings, the EtherCAT field bus system and its motion control configuration will be deleted from your project!

Configuration of Ethernet PG/OP channel

1. Click in the *Project tree* at *'Devices and networking'*.
⇒ You will get a graphical object view of your CPU.

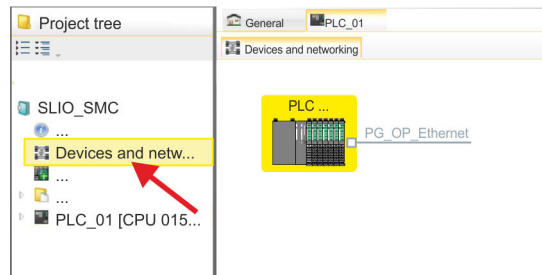

2. Click at the network *'PG_OP_Ethernet'*.
3. Select *'Context menu → Interface properties'*.
⇒ A dialog window opens. Here you can enter the IP address data for your Ethernet PG/OP channel. You get valid IP address parameters from your system administrator.
4. Confirm with [OK].
⇒ The IP address data are stored in your project listed in *'Devices and networking'* at *'Local components'*.
After transferring your project your CPU can be accessed via Ethernet PG/OP channel with the set IP address data.

Installing the ESI file

For the *Sigma-7* EtherCAT drive can be configured in the *SPEED7 EtherCAT Manager*, the corresponding ESI file must be installed. Usually, the *SPEED7 Studio* is delivered with current ESI files and you can skip this part. If your ESI file is not up-to date, you will find the latest ESI file for the *Sigma-7* EtherCAT drive under www.yaskawa.eu.com at *'Service → Drives & Motion Software'*.

1. Download the according ESI file for your drive. Unzip this if necessary.
2. Navigate to your *SPEED7 Studio*.
3. Open the corresponding dialog window by clicking on *'Extra → Install device description (EtherCAT - ESI)'*.
4. Under *'Source path'*, specify the ESI file and install it with [Install].
⇒ The devices of the ESI file are now available.

Add a Sigma-7S single axis drive

1. Click in the Project tree at *'Devices and networking'*.
2. Click here at *'EC-Mastersystem'* and select *'Context menu → Add new device'*.

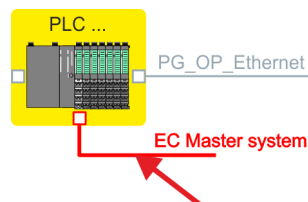

- ⇒ The device template for selecting an EtherCAT device opens.

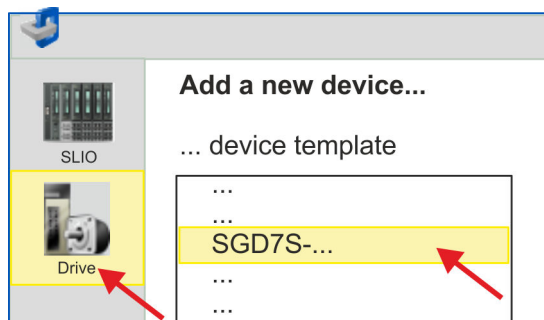

3. Select your *Sigma-7* drive:

- SGD7S-xxxAA0...
- SGD7S-xxxDA0...
- SGD7S-xxxxA0...

Confirm with [OK]. If your drive does not exist, you must install the corresponding ESI file as described above.

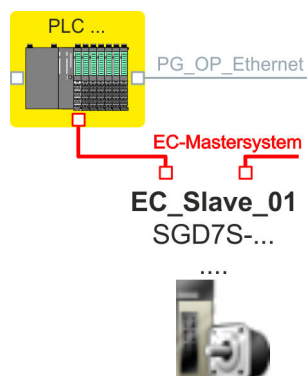

⇒ The *Sigma-7* drive is connected to your EC-Mastersystem.

Configure Sigma-7S single axis drive

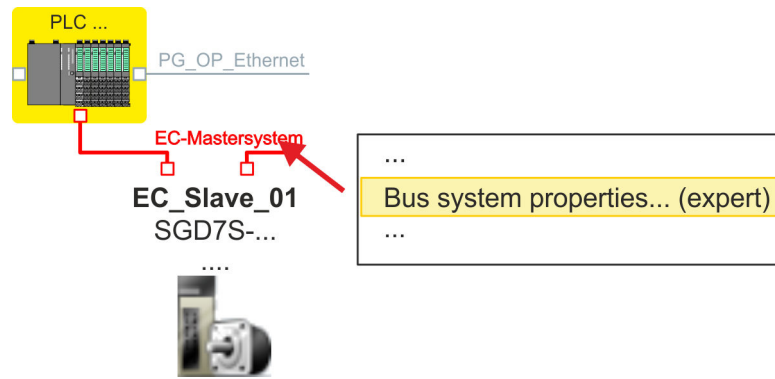

1. Click here at 'EC-Mastersystem' and select 'Context menu → Bus system properties (expert)'.

i You can only edit PDOs in 'Expert mode'! Otherwise, the buttons are hidden.

- ⇒ The SPEED7 EtherCAT Manager opens. Here you can configure the EtherCAT communication to your Sigma-7 drive.

More information about the usage of the SPEED7 EtherCAT Manager may be found in the online help of the SPEED7 Studio.

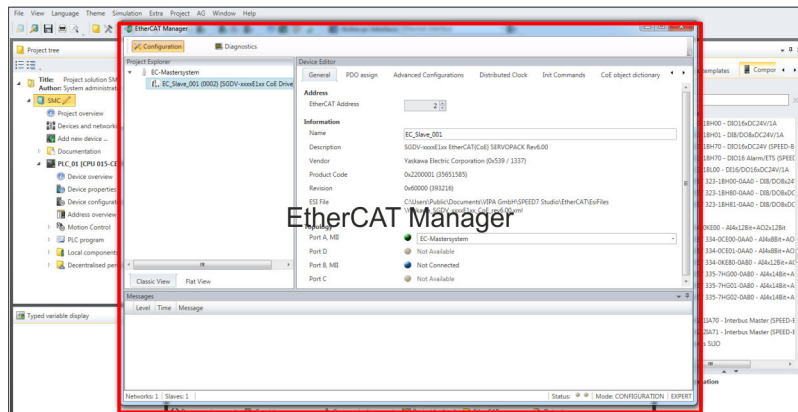

2. Click on the slave in the SPEED7 EtherCAT Manager and select the 'PDO assign' tab in the 'Device editor'.

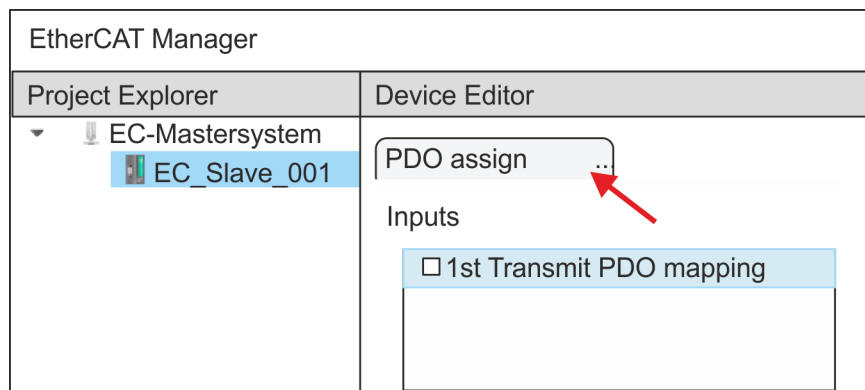

- ⇒ This dialog shows a list of the PDOs.

3. ➔ By selecting the appropriate mapping, you can edit the PDOs with [Edit]. Select the mapping '1st Transmit PDO mapping' and click at [Edit].



Please note that some PDOs can not be edited because of the default settings. By de-activating already activated PDOs, you can release the processing of locked PDOs.

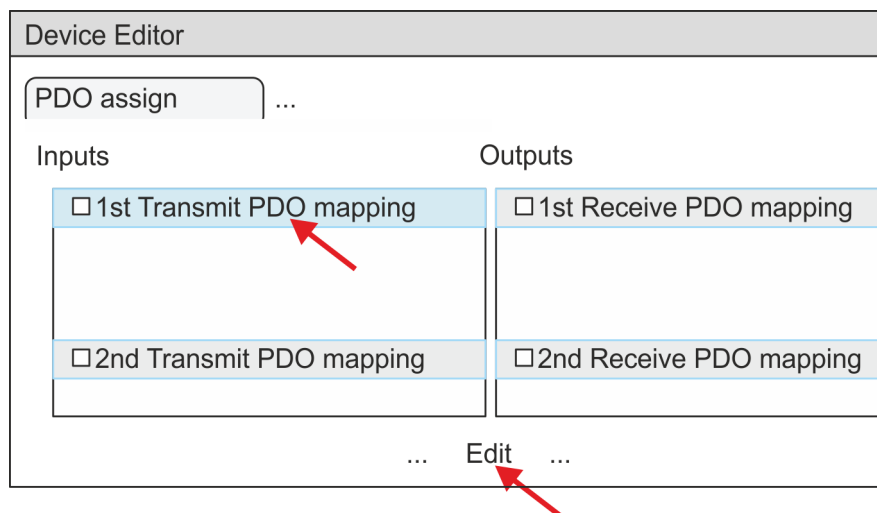

- ⇒ The dialog 'Edit PDO' is opened. Please check the PDO settings listed here and adjust them if necessary. Please also take into account the order of the 'Entries' and add them accordingly.

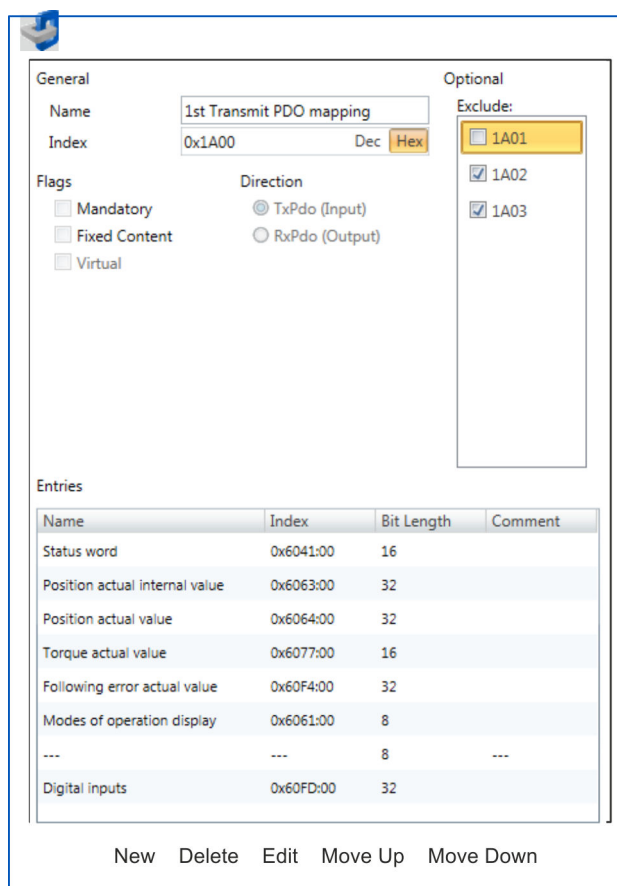

The following functions are available for editing the 'Entries':

- New
 - Here you can create a new entry in a dialog by selecting the corresponding entry from the 'CoE object dictionary' and making your settings. The entry is accepted with [OK] and is listed in the list of entries.
- Delete
 - This allows you to delete a selected entry.
- Edit
 - This allows you to edit the general data of an entry.
- Move Up/Down
 - This allows you to move the selected entry up or down in the list.

4. ► Perform the following settings:

Inputs: 1st Transmit PDO 0x1A00

- General
 - Name: 1st Transmit PDO mapping
 - Index: 0x1A00
- Flags
 - Everything de-activated
- Direction
 - TxPdo (Input): activated
- Exclude

Please note these settings, otherwise the PDO mappings can not be activated at the same time!

 - 1A01: de-activated
- Entries

Name	Index	Bit length
Status word	0x6041:00	16bit
Position actual internal value	0x6063:00	32bit
Position actual value	0x6064:00	32bit
Torque actual value	0x6077:00	16bit
Following error actual value	0x60F4:00	32bit
Modes of operation display	0x6061:00	8bit
---	---	8bit
Digital inputs	0x60FD:00	32bit

Close the dialog 'Edit PDO' with [OK].

5. → Select the mapping '2nd Transmit PDO mapping' and click at [Edit]. Perform the following settings:

Inputs: 2nd Transmit PDO 0x1A01

- General
 - Name: 2nd Transmit PDO mapping
 - Index: 0x1A01
- Flags
 - Everything de-activated
- Direction
 - TxPdo (Input): activated
- Exclude

Please note these settings, otherwise the PDO mappings can not be activated at the same time!

- 1A00: de-activated
- 1A02: de-activated
- 1A03: de-activated
- Entries

Name	Index	Bit length
Touch probe status	0x60B9:00	16bit
Touch probe 1 position value	0x60BA:00	32bit
Touch probe 2 position value	0x60BC:00	32bit
Velocity actual value	0x606C:00	32bit

Close the dialog 'Edit PDO' with [OK].

6. → Select the mapping '1st Receive PDO mapping' and click at [Edit]. Perform the following settings:

Outputs: 1st Receive PDO 0x1600

- General
 - Name: 1st Receive PDO mapping
 - Index: 0x1600
- Flags
 - Everything de-activated
- Direction
 - RxPdo (Output): activated
- Exclude

Please note these settings, otherwise the PDO mappings can not be activated at the same time!

- 1601: de-activated
- 1602: de-activated
- 1603: de-activated

■ Entries

Name	Index	Bit length
Control word	0x6040:00	16bit
Target position	0x607A:00	32bit
Target velocity	0x60FF:00	32bit
Modes of operation	0x6060:00	8bit
---	---	8bit
Touch probe function	0x60B8:00	16bit

Close the dialog 'Edit PDO' with [OK].

7. ➔ Select the mapping '2nd Receive PDO mapping' and click at [Edit]. Perform the following settings:

Outputs: 2nd Receive PDO 0x1601

- General
 - Name: 2nd Receive PDO mapping
 - Index: 0x1601
- Flags
 - Everything de-activated
- Direction
 - RxPdo (Output): activated
- Exclude

Please note these settings, otherwise the PDO mappings can not be activated at the same time!

 - 1600: de-activated
 - 1602: activated
 - 1603: activated
- Entries

Name	Index	Bit length
Profile velocity	0x6081:00	32Bit
Profile acceleration	0x6083:00	32Bit
Profile deceleration	0x6084:00	32Bit

Close the dialog 'Edit PDO' with [OK].

8. ➔ In PDO assignment, activate the PDOs 1 and 2 for the inputs and outputs. All subsequent PDOs must remain de-activated. If this is not possible, please check the respective PDO parameter 'Exclude'.

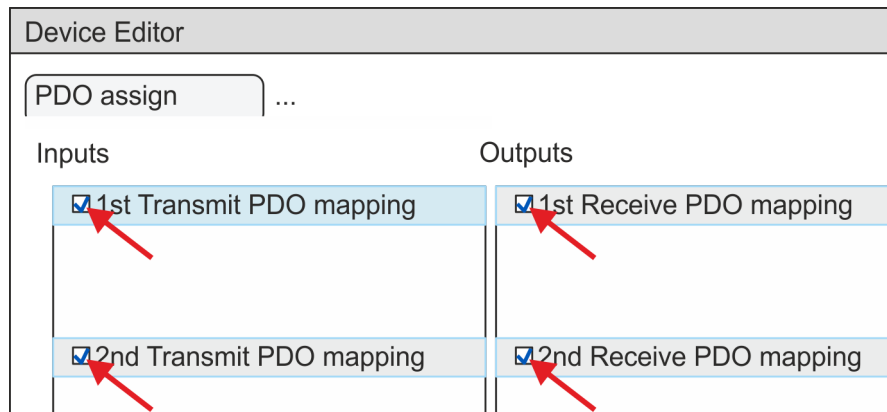

9. ➔ In the 'Device Editor' of the SPEED7 EtherCAT Manager, select the 'Distributed clocks' tab and set 'DC unused' as 'Operating mode'.

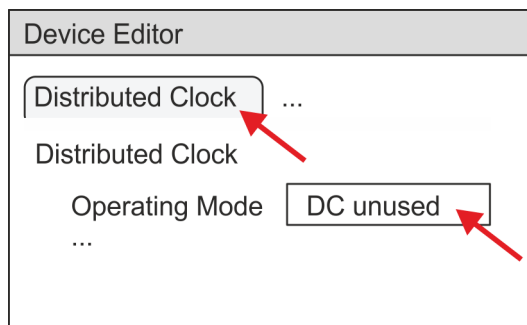

10. Select the 'Process image' tab via the arrow key in the 'Device editor' and note for the parameter of the block FB 873 - VMC_InitSigma7S_EC the following PDO.
 - 'S7 Input address' → 'InputsStartAddressPDO'
 - 'S7 Output address' → 'OutputsStartAddressPDO'

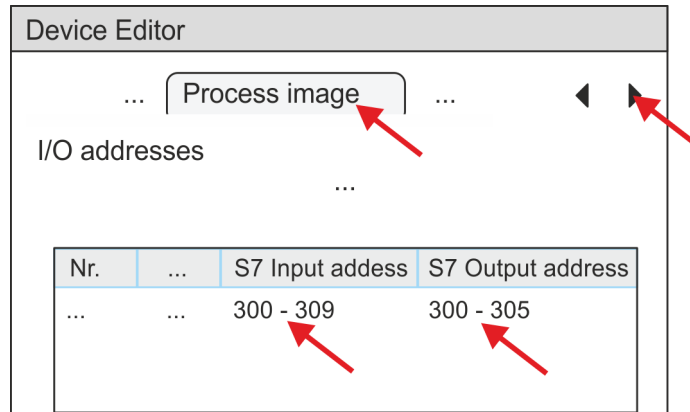

11. Click on 'EC-Mastersystem' in the SPEED7 EtherCAT Manager and select the 'Master' tab in the 'Device editor'.

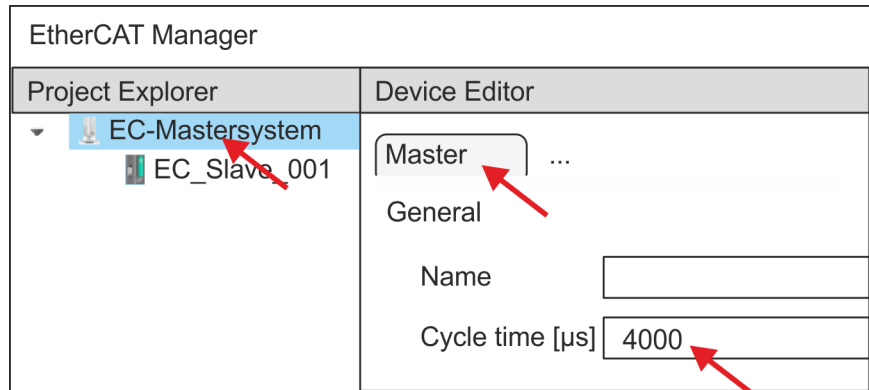

⇒ Set a cycle time of at least 4ms for Sigma-7S (400V) drives (SGD7S-xxxDA0 ... and SGD7S-xxxxA0 ...). Otherwise, leave the value at 1ms.

12. By closing the dialog of the SPEED7 EtherCAT Manager with [X] the configuration is taken to the SPEED7 Studio.

13.2.2.3.2 User program

Program structure

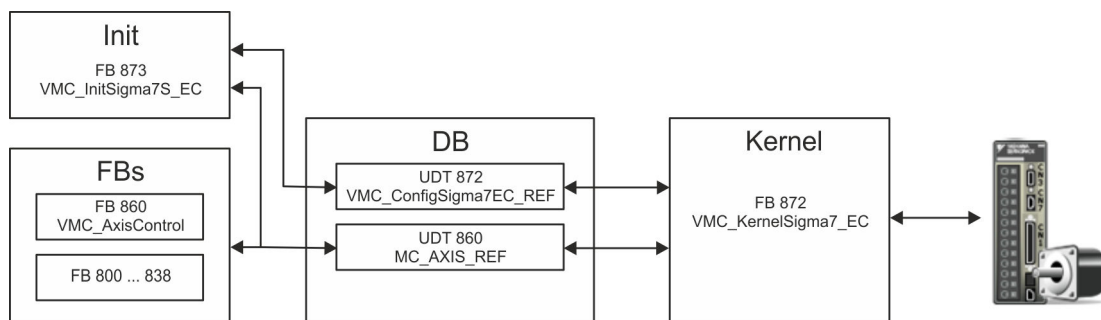

- DB
 - A data block (axis DB) for configuration and status data must be created for each axis of a drive. The data block consists of the following data structures:
 - UDT 872 - *VMC_ConfigSigma7EC_REF*
The data structure describes the structure of the configuration of the drive. Specific data structure for *Sigma-7* EtherCAT.
 - UDT 860 - *MC_AXIS_REF*
The data structure describes the structure of the parameters and status information of drives. General data structure for all drives and bus systems.
- FB 873 - *VMC_InitSigma7S_EC*
 - The *Init* block is used to configure an axis.
 - Specific block for *Sigma-7S* EtherCAT.
 - The configuration data for the initialization must be stored in the *axis DB*.
- FB 872 - *VMC_KernelSigma7_EC*
 - The *Kernel* block communicates with the drive via the appropriate bus system, processes the user requests and returns status messages.
 - Specific block for *Sigma-7* EtherCAT.
 - The exchange of the data takes place by means of the *axis DB*.
- FB 860 - *VMC_AxisControl*
 - General block for all drives and bus systems.
 - Supports simple motion commands and returns all relevant status messages.
 - The exchange of the data takes place by means of the *axis DB*.
 - For motion control and status query, via the instance data of the block you can link a visualization.
 - In addition to the FB 860 - *VMC_AxisControl*, *PLCopen* blocks can be used.
- FB 800 ... FB 838 - *PLCopen*
 - The *PLCopen* blocks are used to program motion sequences and status queries.
 - General blocks for all drives and bus systems.

Programming

Copy blocks into project

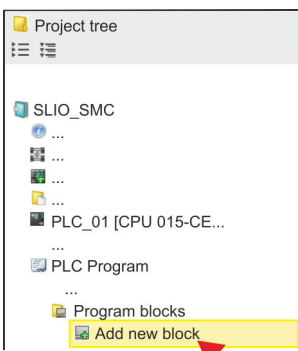

1. Click in the *Project tree* within the CPU at '*PLC program*', '*Program blocks*' at '*Add New block*'.

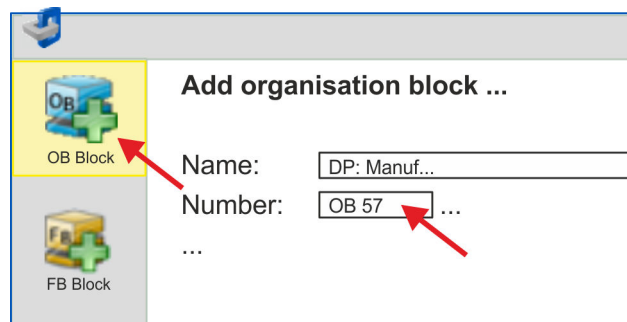

⇒ The dialog '*Add block*' is opened.

2. Select the block type '*OB block*' and add one after the other OB 57, OB 82 and OB 86 to your project.

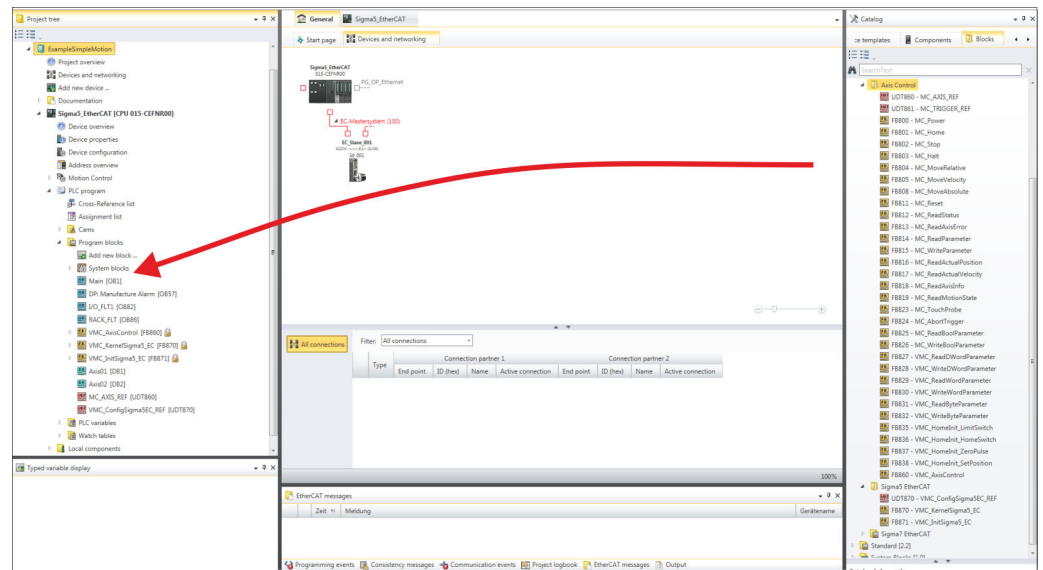

3. In the 'Catalog', open the 'Simple Motion Control' library at 'Blocks' and drag and drop the following blocks into 'Program blocks' of the Project tree:

- Sigma-7 EtherCAT:
 - UDT 872 - VMC_ConfigSigma7EC_REF
 - FB 872 - VMC_KernelSigma7_EC
 - FB 873 - VMC_InitSigma7S_EC
- Axis Control
 - UDT 860 - MC_AXIS_REF
 - Blocks for your movement sequences

Create axis DB

1. Add a new DB as your axis DB to your project. Click in the Project tree within the CPU at 'PLC program', 'Program blocks' at 'Add New block', select the block type 'DB block' and assign the name "Axis01" to it. The DB number can freely be selected such as DB10.

⇒ The block is created and opened.

2. ■ In "Axis01", create the variable "Config" of type UDT 872. These are specific axis configuration data.
- In "Axis01", create the variable "Axis" of type UDT 860. During operation, all operating data of the axis are stored here.

Axis01 [DB10]
Data block structure

Adr...	Name	Data type	...
...	Config	UDT	[872]
...	Axis	UDT	[860]

OB 1

Configuration of the axis

Open OB 1 and program the following FB calls with associated DBs:

→ FB 873 - VMC_InitSigma7S_EC, DB 873 ↪ *Chap. 13.2.2.5.3 'FB 873 - VMC_InitSigma7S_EC - Sigma-7S EtherCAT Initialization' page 360*

At *InputsStartAddressPDO* respectively *OutputsStartAddressPDO*, enter the address from the *SPEED7 EtherCAT Manager*. ↪ 336

```
⇒ CALL "VMC_InitSigma7S_EC" , "DI_InitSgm7SETC01"
   Enable           := "Inits7SEC1_Enable"
   LogicalAddress   := 300
   InputsStartAddressPDO := 300 (EtherCAT-Man.: S7 Input
   address)
   OutputsStartAddressPDO := 300 (EtherCAT-Man.: S7 Output
   address)
   EncoderType      := 1
   EncoderResolutionBits := 20
   FactorPosition   := 1.048576e+006
   FactorVelocity   := 1.048576e+006
   FactorAcceleration := 1.048576e+002
   OffsetPosition   := 0.000000e+000
   MaxVelocityApp   := 5.000000e+001
   MaxAccelerationApp := 1.000000e+002
   MaxDecelerationApp := 1.000000e+002
   MaxVelocityDrive := 6.000000e+001
   MaxAccelerationDrive := 1.500000e+002
   MaxDecelerationDrive := 1.500000e+002
   MaxPosition      := 1.048500e+003
   MinPosition      := -1.048514e+003
   EnableMaxPosition := TRUE
   EnableMinPosition := TRUE
   MinUserPosition   := "Inits7SEC1_MinUserPos"
   MaxUserPosition   := "Inits7SEC1_MaxUserPos"
   Valid             := "Inits7SEC1_Valid"
   Error             := "Inits7SEC1_Error"
   ErrorID           := "Inits7SEC1_ErrorID"
   Config            := "Axis01".Config
   Axis              := "Axis01".Axis
```

Connecting the Kernel for the axis

The *Kernel* processes the user commands and passes them appropriately processed on to the drive via the respective bus system.

→ FB 872 - VMC_KernelSigma7_EC, DB 872 ↪ *Chap. 13.2.2.5.2 'FB 872 - VMC_KernelSigma7_EC - Sigma-7 EtherCAT Kernel' page 360*

```
⇒ CALL "VMC_KernelSigma7_EC" , "DI_KernelSgm5ETC01"
   Init := "KernelS7SEC1_Init"
   Config := "Axis01".Config
   Axis := "Axis01".Axis
```

Connecting the block for motion sequences

For simplicity, the connection of the FB 860 - VMC_AxisControl is to be shown here. This universal block supports simple motion commands and returns status messages. The inputs and outputs can be individually connected. Please specify the reference to the corresponding axis data at 'Axis' in the axis DB.

→ FB 860 - VMC_AxisControl, DB 860 ↪ *Chap. 13.7.2.2 'FB 860 - VMC_AxisControl - Control block axis control' page 544*

```
⇒ CALL "VMC_AxisControl" , "DI_AxisControl01"
   AxisEnable           := "AxCtrl1_AxisEnable"
   AxisReset            := "AxCtrl1_AxisReset"
   HomeExecute          := "AxCtrl1_HomeExecute"
   HomePosition         := "AxCtrl1_HomePosition"
   StopExecute          := "AxCtrl1_StopExecute"
   MvVelocityExecute    := "AxCtrl1_MvVelExecute"
   MvRelativeExecute    := "AxCtrl1_MvRelExecute"
   MvAbsoluteExecute    := "AxCtrl1_MvAbsExecute"
   PositionDistance     := "AxCtrl1_PositionDistance"
   Velocity             := "AxCtrl1_Velocity"
   Acceleration         := "AxCtrl1_Acceleration"
   Deceleration         := "AxCtrl1_Deceleration"
   JogPositive          := "AxCtrl1_JogPositive"
   JogNegative          := "AxCtrl1_JogNegative"
   JogVelocity          := "AxCtrl1_JogVelocity"
   JogAcceleration     := "AxCtrl1_JogAcceleration"
   JogDeceleration     := "AxCtrl1_JogDeceleration"
   AxisReady           := "AxCtrl1_AxisReady"
   AxisEnabled          := "AxCtrl1_AxisEnabled"
   AxisError            := "AxCtrl1_AxisError"
   AxisErrorID         := "AxCtrl1_AxisErrorID"
   DriveWarning        := "AxCtrl1_DriveWarning"
   DriveError          := "AxCtrl1_DriveError"
   DriveErrorID        := "AxCtrl1_DriveErrorID"
   IsHomed             := "AxCtrl1_IsHomed"
   ModeOfOperation     := "AxCtrl1_ModeOfOperation"
   PLCopenState        := "AxCtrl1_PLCopenState"
   ActualPosition       := "AxCtrl1_ActualPosition"
   ActualVelocity       := "AxCtrl1_ActualVelocity"
   CmdDone             := "AxCtrl1_CmdDone"
   CmdBusy             := "AxCtrl1_CmdBusy"
   CmdAborted          := "AxCtrl1_CmdAborted"
   CmdError            := "AxCtrl1_CmdError"
   CmdErrorID          := "AxCtrl1_CmdErrorID"
   DirectionPositive    := "AxCtrl1_DirectionPos"
   DirectionNegative    := "AxCtrl1_DirectionNeg"
   SWLimitMinActive    := "AxCtrl1_SWLimitMinActive"
   SWLimitMaxActive    := "AxCtrl1_SWLimitMaxActive"
   HWLimitMinActive    := "AxCtrl1_HWLimitMinActive"
   HWLimitMaxActive    := "AxCtrl1_HWLimitMaxActive"
   Axis                 := "Axis01".Axis
```



For complex motion tasks, you can use the PLCopen blocks. Please specify the reference to the corresponding axis data at Axis in the axis DB.

Your project now includes the following blocks:

- OB 1 - Main
- OB 57 - DP Manufacturer Alarm
- OB 82 - I/O_FLT1
- OB 86 - Rack_FLT
- FB 860 - VMC_AxisControl with instance DB

- FB 872 - VMC_KernelSigma7_EC with instance DB
- FB 873 - VMC_InitSigma7S_EC with instance DB
- UDT 860 - MC_Axis_REF
- UDT 872 - VMC_ConfigSigma7EC_REF

Sequence of operations

1. ➤ Select *'Project → Compile all'* and transfer the project into your CPU. You can find more information on the transfer of your project in the online help of the *SPEED7 Studio*.

⇒ You can take your application into operation now.



CAUTION!

Please always observe the safety instructions for your drive, especially during commissioning!

2. ➤ Before an axis can be controlled, it must be initialized. To do this, call the *Init* block FB 873 - VMC_InitSigma7S_EC with *Enable* = TRUE.

⇒ The output *Valid* returns TRUE. In the event of a fault, you can determine the error by evaluating the *ErrorID*.

You have to call the *Init* block again if you load a new axis DB or you have changed parameters on the *Init* block.



Do not continue until the Init block does not report any errors!

3. ➤ Ensure that the *Kernel* block FB 872 - VMC_KernelSigma7_EC is called cyclically. In this way, control signals are transmitted to the drive and status messages are reported.
4. ➤ Program your application with the FB 860 - VMC_AxisControl or with the PLCopen blocks.

Controlling the drive via HMI

There is the possibility to control your drive via HMI. For this, a predefined symbol library is available for Movicon to access the VMC_AxisControl function block. ↪ *Chap. 13.8 'Controlling the drive via HMI' page 613*

13.2.2.4 Usage in Siemens SIMATIC Manager







13.2.2.4.1 Precondition

Overview

- Please use for configuration the Siemens SIMATIC Manager V 5.5 SP2 and up.
- The configuration of the System SLIO CPU happens in the Siemens SIMATIC Manager by means of a virtual PROFINET IO device *'VIPA SLIO CPU'*. The *'VIPA SLIO CPU'* is to be installed in the hardware catalog by means of the GSDML.
- The configuration of the EtherCAT masters happens in the Siemens SIMATIC Manager by means of a virtual PROFINET IO device *'EtherCAT network'*. The *'EtherCAT network'* is to be installed in the hardware catalog by means of the GSDML.
- The *'EtherCAT network'* can be configured with the VIPA Tool *SPEED7 EtherCAT Manager*.
- For the configuration of the drive in the *SPEED7 EtherCAT Manager* the installation of the according ESI file is necessary.







**Installing the IO device
'VIPA SLIO System'**

The installation of the PROFINET IO device 'VIPA SLIO CPU' happens in the hardware catalog with the following approach:

1.  Go to the service area of www.vipa.com.
2.  Download the configuration file for your CPU from the download area via 'Config files → PROFINET'.
3.  Extract the file into your working directory.
4.  Start the Siemens hardware configurator.
5.  Close all the projects.
6.  Select 'Options → Install new GSD file'.
7.  Navigate to your working directory and install the according GSDML file.
 - ⇒ After the installation the according PROFINET IO device can be found at 'PROFINET IO → Additional field devices → I/O → VIPA SLIO System'.

**Installing the IO device
EtherCAT network**









The installation of the PROFINET IO devices 'EtherCAT Network' happens in the hardware catalog with the following approach:

1.  Go to the service area of www.vipa.com
2.  Load from the download area at 'Config files → EtherCAT' the GSDML file for your EtherCAT master.
3.  Extract the files into your working directory.
4.  Start the Siemens hardware configurator.
5.  Close all the projects.
6.  Select 'Options → Install new GSD file'.
7.  Navigate to your working directory and install the according GSDML file.
 - ⇒ After the installation the 'EtherCAT Network' can be found at 'PROFINET IO → Additional field devices → I/O → VIPA VIPA EtherCAT System'.

**Installing the SPEED7
EtherCAT Manager**

The configuration of the PROFINET IO device 'EtherCAT Network' happens by means of the *SPEED7 EtherCAT Manager* from VIPA. This may be found in the service area of www.vipa.com at 'Service/Support → Downloads → Software'.

The installation happens with the following proceeding:

1.  Close the Siemens SIMATIC Manager.
2.  Go to the service area of www.vipa.com
3.  Load the *SPEED7 EtherCAT Manager* and unzip it on your PC.
4.  For installation start the file *EtherCATManager_v... .exe*.
5.  Select the language for the installation.
6.  Accept the licensing agreement.
7.  Select the installation directory and start the installation.
8.  After installation you have to reboot your PC.
 - ⇒ The *SPEED7 EtherCAT Manager* is installed and can now be called via the context menu of the Siemens SIMATIC Manager.

13.2.2.4.2 Hardware configuration

Configuring the CPU in the project

Slot	Module
1	
2	CPU 315-2 PN/DP
X1	MPI/DP
X2	PN-IO
X2...	Port 1
X2...	Port 2
3	

To be compatible with the Siemens SIMATIC Manager the following steps should be executed:

1. Start the Siemens hardware configurator with a new project.
2. Insert a profile rail from the hardware catalog.
3. Place at 'Slot' number 2 the CPU 315-2 PN/DP (315-2EH14 V3.2).
4. The integrated PROFIBUS DP master (jack X3) is to be configured and connected via the sub module 'X1 MPI/DP'.
5. The integrated EtherCAT master is to be configured via the sub module 'X2 PN-IO' as a virtual PROFINET network.
6. Click at the sub module 'PN-IO' of the CPU.
7. Select 'Context menu → Insert PROFINET IO System'.

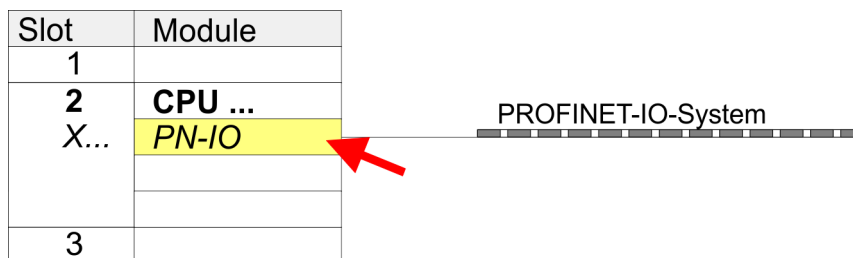

8. Create with [New] a new sub net and assign valid address data
9. Click at the sub module 'PN-IO' of the CPU and open with 'Context menu → Properties' the properties dialog.
10. Enter at 'General' a 'Device name'. The device name must be unique at the Ethernet subnet.

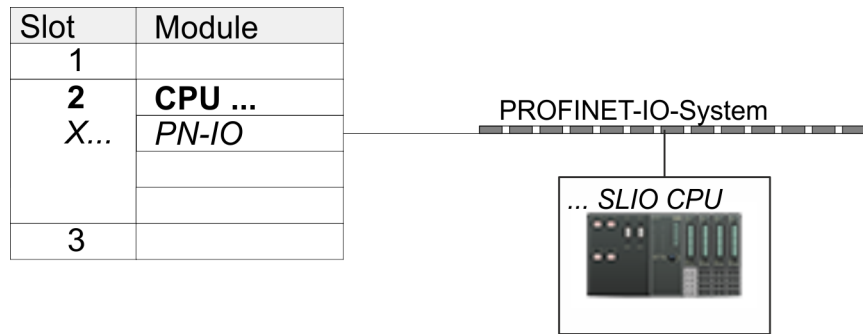

Slot	Module	Order number
0	... SLIO CPU ...	015-...
X2	015-...	
1		
2		
3		
...		

1. Navigate in the hardware catalog to the directory '*PROFINET IO*' → *Additional field devices* → *I/O* → *VIPA SLIO System*' and connect the IO device '*015-CFFNR00 CPU*' to your PROFINET system.
 - ⇒ In the Device overview of the PROFINET IO device '*VIPA SLIO CPU*' the CPU is already placed at slot 0. From slot 1 you can place your System SLIO modules.

Configuration of Ethernet PG/OP channel

Slot	Module
1	
2	CPU ...
X...	<i>PN-IO</i>
3	
4	343-1EX30
5	
...	

1. Place for the Ethernet PG/OP channel at slot 4 the Siemens CP 343-1 (SIMATIC 300 \ CP 300 \ Industrial Ethernet \ CP 343-1 \ 6GK7 343-1EX30 0XE0 V3.0).
2. Open the properties dialog by clicking on the CP 343-1EX30 and enter for the CP at '*Properties*' the IP address data. You get valid IP address parameters from your system administrator.
3. Assign the CP to a '*Subnet*'. The IP address data are not accepted without assignment!

Insert 'EtherCAT network'

Slot	Module
1	
2	CPU ...
X...	<i>PN-IO</i>
3	

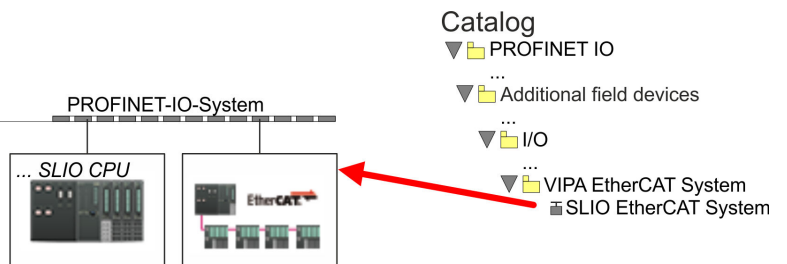

1. Navigate in the hardware catalog to the directory '*PROFINET IO*' → *Additional field devices* → *I/O* → *VIPA EtherCAT System*' and connect the IO device '*SLIO EtherCAT System*' to your PROFINET system.

2. Click at the inserted IO device 'EtherCAT Network' and define the areas for in and output by drag and dropping the according 'Out' or 'In' area to a slot.

Create the following areas:

- In 128byte
- Out 128byte

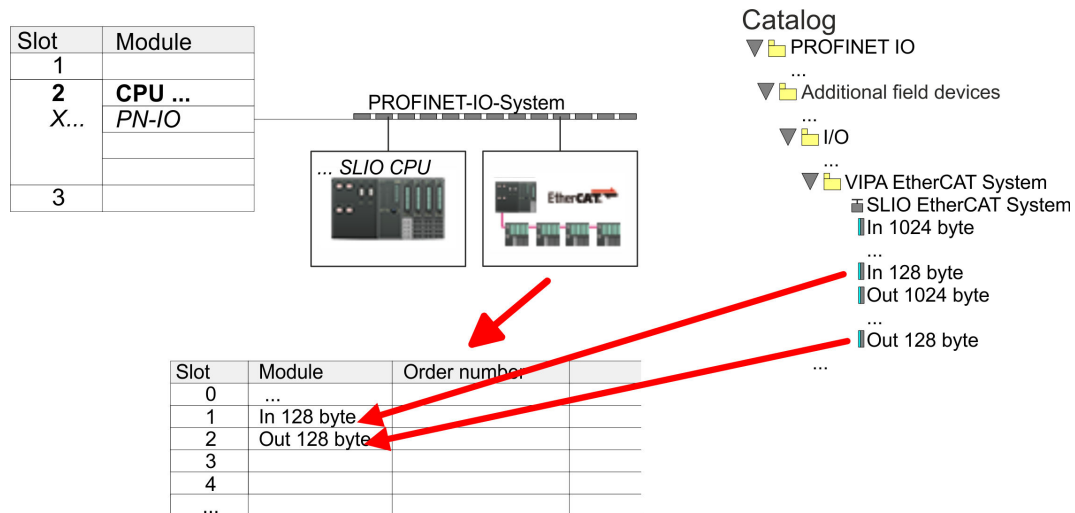

3. Select 'Station → Save and compile'

Sigma-7S Configure EtherCAT drive

The drive is configured in the *SPEED7 EtherCAT Manager*.



Before calling the *SPEED7 EtherCAT Manager* you have always to save your project with 'Station → Save and compile'.

Slot	Module
1	
2	CPU ...
X...	PN-IO
3	

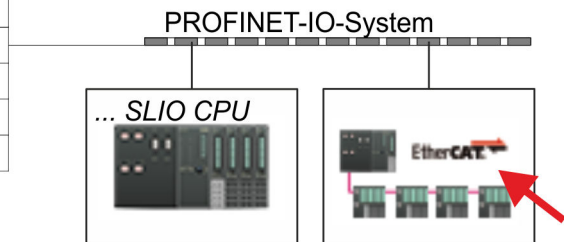

- Click at an inserted IO device 'EtherCAT Network' and select 'Context menu → Start Device-Tool → SPEED7 EtherCAT Manager'.
 - ⇒ The *SPEED7 EtherCAT Manager* opens. Here you can configure the EtherCAT communication to your *Sigma-7S* drive.

More information about the usage of the *SPEED7 EtherCAT Manager* may be found in the according manual or online help.

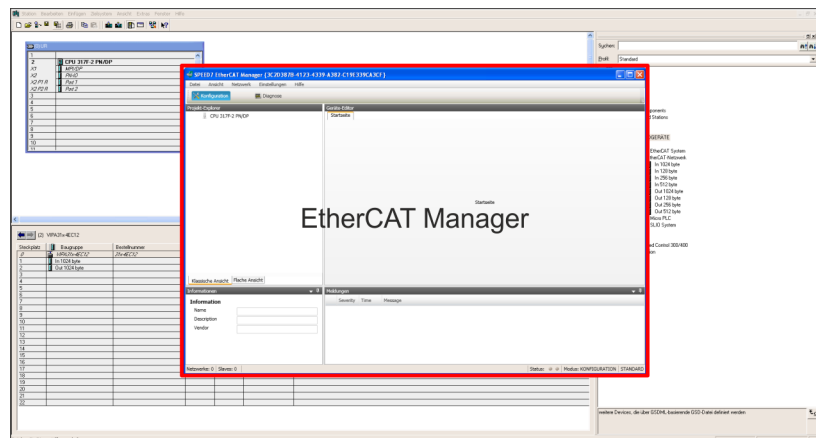

- For the *Sigma-7S* EtherCAT drive to be configured in the *SPEED7 EtherCAT Manager*, the corresponding ESI file must be installed. The ESI file for the *Sigma-7S* EtherCAT drive can be found under www.yaskawa.eu.com at 'Service → Drives & Motion Software'. Download the according ESI file for your drive. Unzip this if necessary.
- Open in the *SPEED7 EtherCAT Manager* via 'File → ESI Manager' the dialogue window 'ESI Manager'.
- In the 'ESI Manager' click at [Add File] and select your ESI file. With [Open], the ESI file is installed in the *SPEED7 EtherCAT Manager*.
- Close the 'ESI Manager'.
 - ⇒ Your *Sigma-7S* EtherCAT drive is now available for configuration.

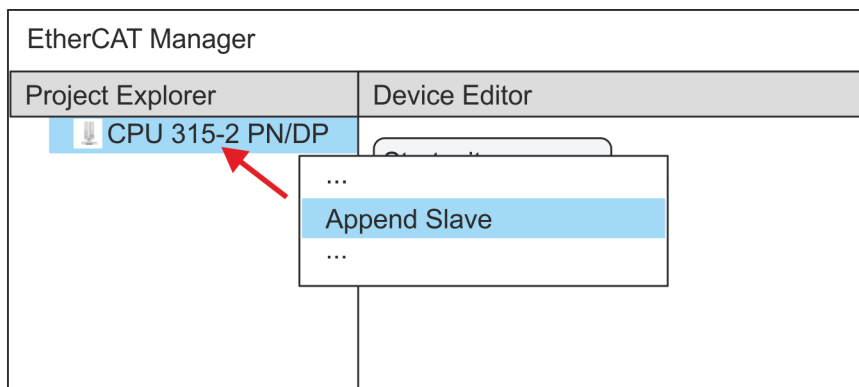

7. In the EtherCAT Manager, click on your CPU and open via 'Context menu' → 'Append Slave' the dialog box for adding an EtherCAT slave.
 - ⇒ The dialog window for selecting an EtherCAT slave is opened.
8. Select your *Sigma-7S* EtherCAT drive and confirm your selection with [OK].
 - ⇒ The *Sigma-7S* EtherCAT drive is connected to the master and can now be configured.

9.



You can only edit PDOs in 'Expert mode'! Otherwise, the buttons are hidden. By activating the 'Expert mode' you can switch to advanced setting.

By activating 'View → Expert' you can switch to the *Expert mode*.

10. Click on the *Sigma-7S* EtherCAT Slave in the *SPEED7 EtherCAT Manager* and select the 'PDO assign' tab in the 'Device editor'.

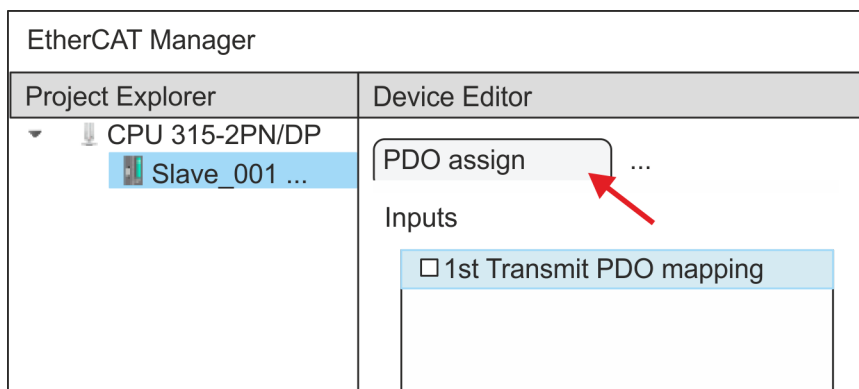

- ⇒ This dialog shows a list of the PDOs.

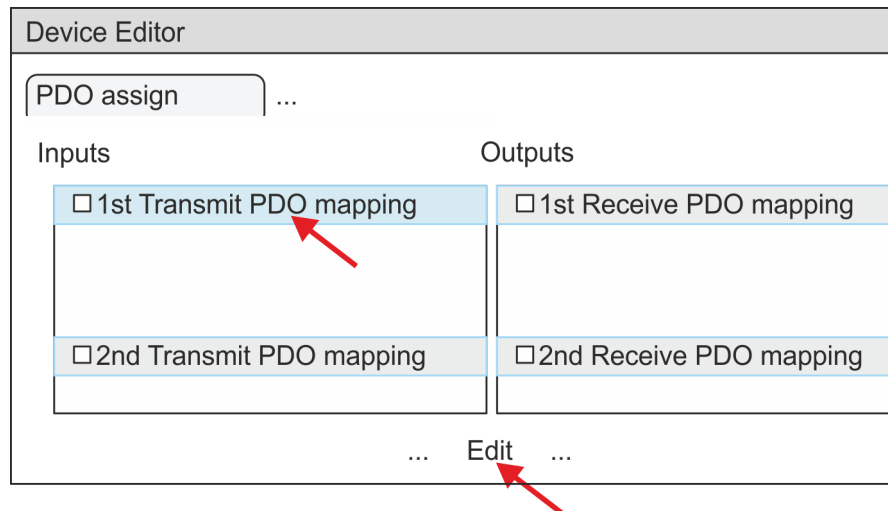

11. By selecting the appropriate PDO mapping, you can edit the PDOs with [Edit]. Select the mapping '1st Transmit PDO mapping' and click at [Edit].



Please note that some PDOs can not be edited because of the default settings. By de-activating already activated PDOs, you can release the processing of locked PDOs.

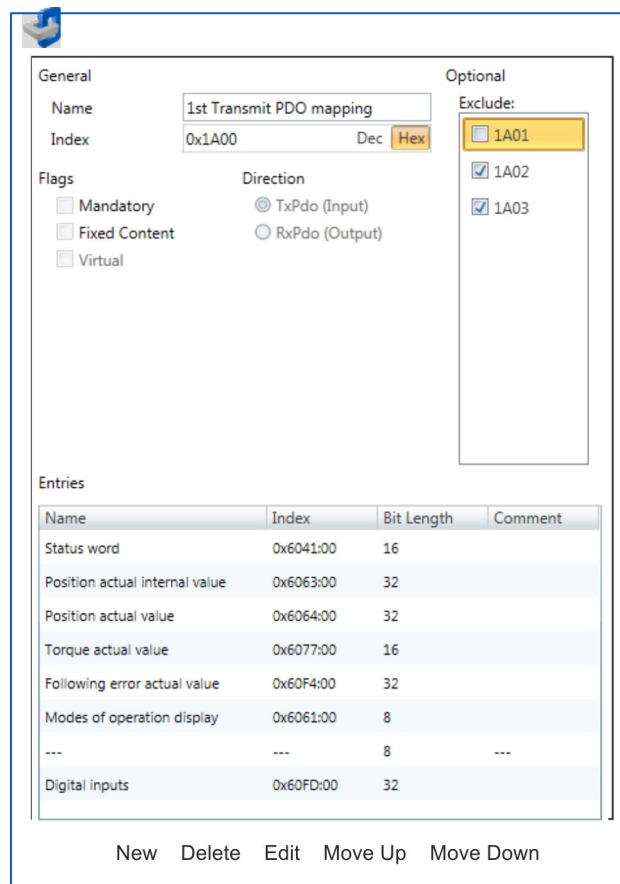

- ⇒ The dialog 'Edit PDO' is opened. Please check the PDO settings listed here and adjust them if necessary. Please also take into account the order of the 'Entries' and add them accordingly.

The following functions are available for editing the 'Entries':

- New
 - Here you can create a new entry in a dialog by selecting the corresponding entry from the 'CoE object dictionary' and making your settings. The entry is accepted with [OK] and is listed in the list of entries.
- Delete
 - This allows you to delete a selected entry.
- Edit
 - This allows you to edit the general data of an entry.
- Move Up/Down
 - This allows you to move the selected entry up or down in the list.

12. Perform the following settings:

Inputs: 1st Transmit PDO 0x1A00

- General
 - Name: 1st Transmit PDO mapping
 - Index: 0x1A00
- Flags
 - Everything de-activated
- Direction
 - TxPdo (Input): activated
- Exclude

Please note these settings, otherwise the PDO mappings can not be activated at the same time!

 - 1A01: de-activated
- Entries

Name	Index	Bit length
Status word	0x6041:00	16bit
Position actual internal value	0x6063:00	32bit
Position actual value	0x6064:00	32bit
Torque actual value	0x6077:00	16bit
Following error actual value	0x60F4:00	32bit
Modes of operation display	0x6061:00	8bit
---	---	8bit
Digital inputs	0x60FD:00	32bit

Close the dialog 'Edit PDO' with [OK].

- 13.** Select the mapping '2nd Transmit PDO mapping' and click at [Edit]. Perform the following settings:

Inputs: 2nd Transmit PDO 0x1A01

- General
 - Name: 2nd Transmit PDO mapping
 - Index: 0x1A01
- Flags
 - Everything de-activated
- Direction
 - TxPdo (Input): activated
- Exclude

Please note these settings, otherwise the PDO mappings can not be activated at the same time!

- 1A00: de-activated
- 1A02: de-activated
- 1A03: de-activated
- Entries

Name	Index	Bit length
Touch probe status	0x60B9:00	16bit
Touch probe 1 position value	0x60BA:00	32bit
Touch probe 2 position value	0x60BC:00	32bit
Velocity actual value	0x606C:00	32bit

Close the dialog 'Edit PDO' with [OK].

- 14.** Select the mapping '1st Receive PDO mapping' and click at [Edit]. Perform the following settings:

Outputs: 1st Receive PDO 0x1600

- General
 - Name: 1st Receive PDO mapping
 - Index: 0x1600
- Flags
 - Everything de-activated
- Direction
 - RxPdo (Output): activated
- Exclude

Please note these settings, otherwise the PDO mappings can not be activated at the same time!

- 1601: de-activated
- 1602: de-activated
- 1603: de-activated
- Entries

Name	Index	Bit length
Control word	0x6040:00	16bit
Target position	0x607A:00	32bit
Target velocity	0x60FF:00	32bit
Modes of operation	0x6060:00	8bit
---	---	8bit
Touch probe function	0x60B8:00	16bit

Close the dialog 'Edit PDO' with [OK].

15. Select the mapping '2nd Receive PDO mapping' and click at [Edit]. Perform the following settings:

Outputs: 2nd Receive PDO 0x1601

- General
 - Name: 2nd Receive PDO mapping
 - Index: 0x1601
- Flags
 - Everything de-activated
- Direction
 - RxPdo (Output): activated
- Exclude

Please note these settings, otherwise the PDO mappings can not be activated at the same time!

- 1600: de-activated
- 1602: activated
- 1603: activated
- Entries

Name	Index	Bit length
Profile velocity	0x6081:00	32bit
Profile acceleration	0x6083:00	32bit
Profile deceleration	0x6084:00	32bit

Close the dialog 'Edit PDO' with [OK].

16. In PDO assignment, activate the PDOs 1 and 2 for the inputs and outputs. All subsequent PDOs must remain de-activated. If this is not possible, please check the respective PDO parameter 'Exclude'.

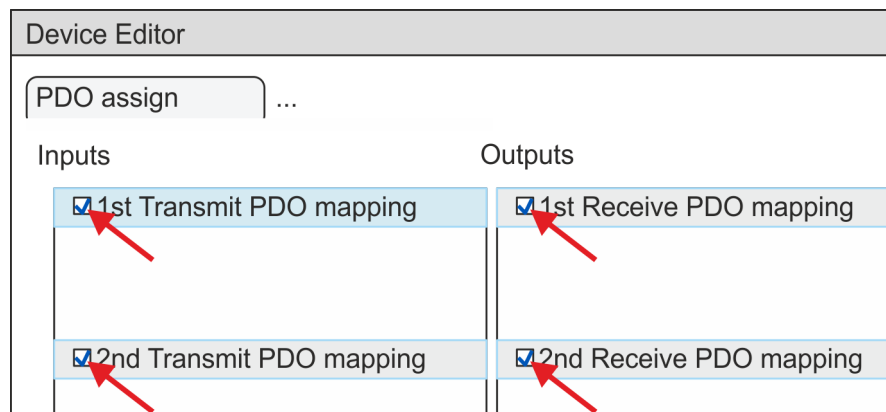

17. In the 'Device Editor' of the SPEED7 EtherCAT Manager, select the 'Distributed clocks' tab and set 'DC unused' as 'Operating mode'.

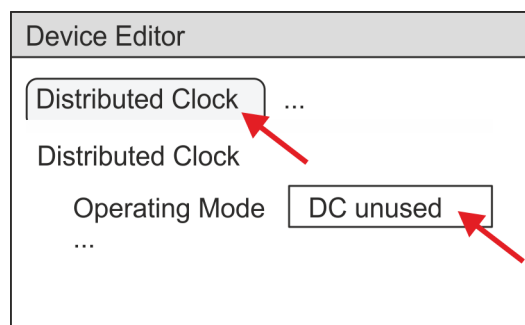

18. Select the 'Process image' tab via the arrow key in the 'Device editor' and note for the parameter of the block FB 873 - VMC_InitSigma7S_EC the following PDO.
 - 'S7 Input address' → 'InputsStartAddressPDO'
 - 'S7 Output address' → 'OutputsStartAddressPDO'

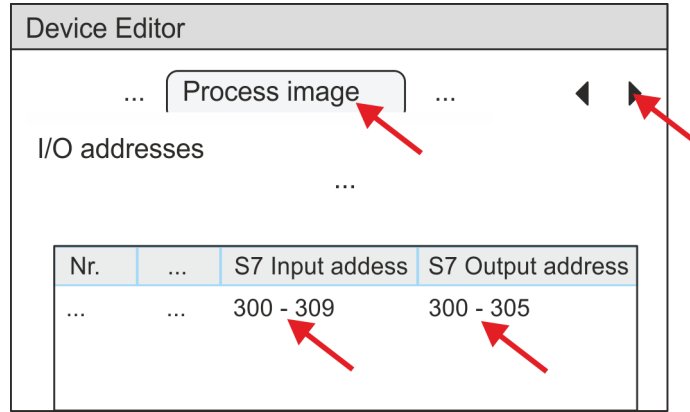

19. Click on your CPU in the *SPEED7 EtherCAT Manager* and select the 'Master' tab in the 'Device editor'.

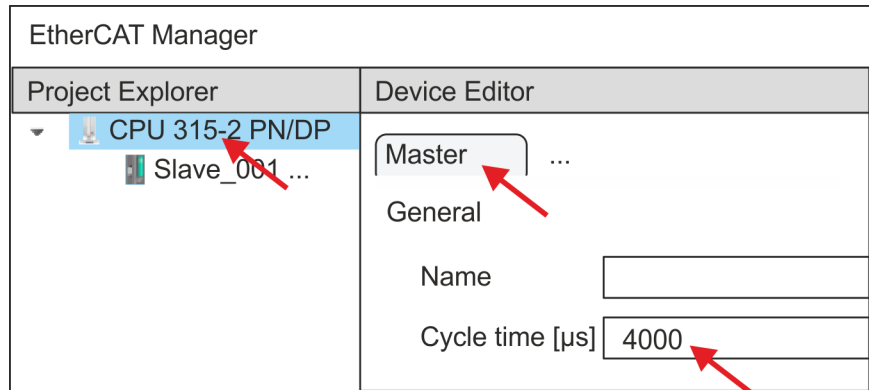

⇒ Set a cycle time of at least 4ms for Sigma-7S (400V) drives (SGD7S-xxxDA0 ... and SGD7S-xxxxA0 ...). Otherwise, leave the value at 1ms.

20. By closing the *SPEED7 EtherCAT Manager* with [X] the configuration is taken to the project. You can always edit your EtherCAT configuration in the *SPEED7 EtherCAT Manager*, since the configuration is stored in your project.
21. Save and compile your configuration.

13.2.2.4.3 User program

Program structure

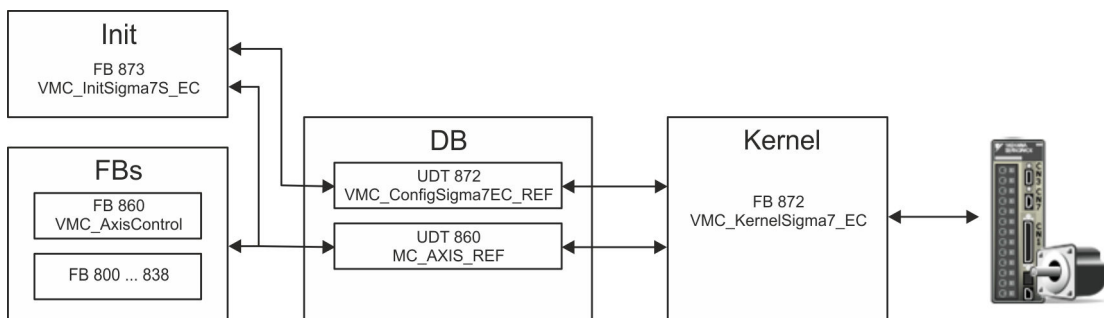

- DB

A data block (axis DB) for configuration and status data must be created for each axis of a drive. The data block consists of the following data structures:

 - UDT 872 - *VMC_ConfigSigma7EC_REF*
The data structure describes the structure of the configuration of the drive. Specific data structure for *Sigma-7* EtherCAT.
 - UDT 860 - *MC_AXIS_REF*
The data structure describes the structure of the parameters and status information of drives.
General data structure for all drives and bus systems.
- FB 873 - *VMC_InitSigma7S_EC*
 - The *Init* block is used to configure an axis.
 - Specific block for *Sigma-7S* EtherCAT.
 - The configuration data for the initialization must be stored in the *axis DB*.
- FB 872 - *VMC_KernelSigma7_EC*
 - The *Kernel* block communicates with the drive via the appropriate bus system, processes the user requests and returns status messages.
 - Specific block for *Sigma-7* EtherCAT.
 - The exchange of the data takes place by means of the *axis DB*.
- FB 860 - *VMC_AxisControl*
 - General block for all drives and bus systems.
 - Supports simple motion commands and returns all relevant status messages.
 - The exchange of the data takes place by means of the *axis DB*.
 - For motion control and status query, via the instance data of the block you can link a visualization.
 - In addition to the FB 860 - *VMC_AxisControl*, *PLCopen* blocks can be used.
- FB 800 ... FB 838 - *PLCopen*
 - The *PLCopen* blocks are used to program motion sequences and status queries.
 - General blocks for all drives and bus systems.

Programming

Include library

1. ➤ Go to the service area of www.vipa.com.
2. ➤ Download the *Simple Motion Control* library from the download area at '*VIPA Lib*'.
3. ➤ Open the dialog window for ZIP file selection via '*File* ➔ *Retrieve*'.
4. ➤ Select the according ZIP file and click at [Open].
5. ➤ Specify a target directory in which the blocks are to be stored and start the unzip process with [OK].

Copy blocks into project

- Open the library after unzipping and drag and drop the following blocks into '*Blocks*' of your project:
 - *Sigma-7S* EtherCAT:
 - UDT 872 - *VMC_ConfigSigma7EC_REF*
 - FB 872 - *VMC_KernelSigma7_EC*
 - FB 873 - *VMC_InitSigma7S_EC*
 - Axis Control
 - UDT 860 - *MC_AXIS_REF*
 - Blocks for your movement sequences

Create interrupt OBs

1. ➤ In your project, click at *'Blocks'* and choose *'Context menu → Insert new object → Organization block'*.
⇒ The dialog *'Properties Organization block'* opens.
2. ➤ Add OB 57, OB 82, and OB 86 successively to your project.

Create axis DB

1. ➤ In your project, click at *'Blocks'* and choose *'Context menu → Insert new object → Data block'*.

Specify the following parameters:

- Name and type
 - The DB no. as *'Name'* can freely be chosen, such as DB10.
 - Set *'Shared DB'* as the *'Type'*.
- Symbolic name
 - Specify "Axis01".

Confirm your input with [OK].

⇒ The block is created.

2. ➤ Open DB10 "Axis01" by double-click.
 - In "Axis01", create the variable "Config" of type UDT 872. These are specific axis configuration data.
 - In "Axis01", create the variable "Axis" of type UDT 860. During operation, all operating data of the axis are stored here.

DB10

Address	Name	Type	...
		Struct	
...	Config	"VMC_ConfigSigma7EC_REF"	
...	Axis	"MC_AXIS_REF"	
...		END_STRUCT	

OB 1**Configuration of the axis**

Open OB 1 and program the following FB calls with associated DBs:

→ FB 873 - VMC_InitSigma7S_EC, DB 873 ↪ *Chap. 13.2.2.5.3 'FB 873 - VMC_InitSigma7S_EC - Sigma-7S EtherCAT Initialization' page 360*

At *InputsStartAddressPDO* respectively *OutputsStartAddressPDO*, enter the address from the *SPEED7 EtherCAT Manager*. ↪ 353

```
⇒ CALL "VMC_InitSigma7S_EC" , "DI_InitSgm7SETC01"
   Enable           := "InitS7SEC1_Enable"
   LogicalAddress   := 300
   InputsStartAddressPDO := 300 (EtherCAT-Man:S7 Input address)
   OutputsStartAddressPDO := 300 (EtherCAT-Man:S7 Output address)
   EncoderType      := 1
   EncoderResolutionBits := 20
   FactorPosition   := 1.048576e+006
   FactorVelocity   := 1.048576e+006
   FactorAcceleration := 1.048576e+002
   OffsetPosition   := 0.000000e+000
   MaxVelocityApp   := 5.000000e+001
   MaxAccelerationApp := 1.000000e+002
   MaxDecelerationApp := 1.000000e+002
   MaxVelocityDrive := 6.000000e+001
   MaxAccelerationDrive := 1.500000e+002
   MaxDecelerationDrive := 1.500000e+002
   MaxPosition      := 1.048500e+003
   MinPosition      := -1.048514e+003
   EnableMaxPosition := TRUE
   EnableMinPosition := TRUE
   MinUserPosition   := "InitS5EC1_MinUserPos"
   MaxUserPosition   := "InitS5EC1_MaxUserPos"
   Valid             := "InitS5EC1_Valid"
   Error             := "InitS5EC1_Error"
   ErrorID           := "InitS5EC1_ErrorID"
   Config            := "Axis01".Config
   Axis              := "Axis01".Axis
```

Connecting the Kernel for the axis

The *Kernel* processes the user commands and passes them appropriately processed on to the drive via the respective bus system.

→ FB 872 - VMC_KernelSigma7_EC, DB 872 ↪ *Chap. 13.2.2.5.2 'FB 872 - VMC_KernelSigma7_EC - Sigma-7 EtherCAT Kernel' page 360*

```
⇒ CALL "VMC_KernelSigma7_EC" , "DI_KernelSgm7ETC01"
   Init := "KernelS7EC1_Init"
   Config := "Axis01".Config
   Axis := "Axis01".Axis
```

Connecting the block for motion sequences

For simplicity, the connection of the FB 860 - VMC_AxisControl is to be shown here. This universal block supports simple motion commands and returns status messages. The inputs and outputs can be individually connected. Please specify the reference to the corresponding axis data at 'Axis' in the axis DB.

→ FB 860 - VMC_AxisControl, DB 860 ↪ *Chap. 13.7.2.2 'FB 860 - VMC_AxisControl - Control block axis control' page 544*

```
⇒ CALL "VMC_AxisControl" , "DI_AxisControl01"
   AxisEnable      := "AxCtrl1_AxisEnable"
   AxisReset       := "AxCtrl1_AxisReset"
   HomeExecute     := "AxCtrl1_HomeExecute"
   HomePosition    := "AxCtrl1_HomePosition"
   StopExecute     := "AxCtrl1_StopExecute"
   MvVelocityExecute := "AxCtrl1_MvVelExecute"
   MvRelativeExecute := "AxCtrl1_MvRelExecute"
   MvAbsoluteExecute := "AxCtrl1_MvAbsExecute"
   PositionDistance := "AxCtrl1_PositionDistance"
   Velocity        := "AxCtrl1_Velocity"
   Acceleration    := "AxCtrl1_Acceleration"
   Deceleration    := "AxCtrl1_Deceleration"
   JogPositive     := "AxCtrl1_JogPositive"
   JogNegative     := "AxCtrl1_JogNegative"
   JogVelocity     := "AxCtrl1_JogVelocity"
   JogAcceleration := "AxCtrl1_JogAcceleration"
   JogDeceleration := "AxCtrl1_JogDeceleration"
   AxisReady      := "AxCtrl1_AxisReady"
   AxisEnabled    := "AxCtrl1_AxisEnabled"
   AxisError      := "AxCtrl1_AxisError"
   AxisErrorID    := "AxCtrl1_AxisErrorID"
   DriveWarning   := "AxCtrl1_DriveWarning"
   DriveError     := "AxCtrl1_DriveError"
   DriveErrorID   := "AxCtrl1_DriveErrorID"
   IsHomed        := "AxCtrl1_IsHomed"
   ModeOfOperation := "AxCtrl1_ModeOfOperation"
   PLCOpenState   := "AxCtrl1_PLCOpenState"
   ActualPosition := "AxCtrl1_ActualPosition"
   ActualVelocity := "AxCtrl1_ActualVelocity"
   CmdDone        := "AxCtrl1_CmdDone"
   CmdBusy        := "AxCtrl1_CmdBusy"
   CmdAborted     := "AxCtrl1_CmdAborted"
   CmdError       := "AxCtrl1_CmdError"
   CmdErrorID    := "AxCtrl1_CmdErrorID"
   DirectionPositive := "AxCtrl1_DirectionPos"
   DirectionNegative := "AxCtrl1_DirectionNeg"
   SWLimitMinActive := "AxCtrl1_SWLimitMinActive"
   SWLimitMaxActive := "AxCtrl1_SWLimitMaxActive"
   HWLimitMinActive := "AxCtrl1_HWLimitMinActive"
   HWLimitMaxActive := "AxCtrl1_HWLimitMaxActive"
   Axis           := "Axis01".Axis
```



For complex motion tasks, you can use the PLCOpen blocks. Please specify the reference to the corresponding axis data at Axis in the axis DB.

Your project now includes the following blocks:

- OB 1 - Main
- OB 57 - DP Manufacturer Alarm
- OB 82 - I/O_FLT1
- OB 86 - Rack_FLT
- FB 860 - VMC_AxisControl with instance DB

- FB 872 - VMC_KernelSigma7_EC with instance DB
- FB 873 - VMC_InitSigma7S_EC with instance DB
- UDT 860 - MC_Axis_REF
- UDT 872 - VMC_ConfigSigma7EC_REF

Sequence of operations

1. ➔ Choose the Siemens SIMATIC Manager and transfer your project into the CPU.
The transfer can only be done by the Siemens SIMATIC Manager - not hardware configurator!



Since slave and module parameters are transmitted by means of SDO respectively SDO Init command, the configuration remains active, until a power cycle is performed or new parameters for the same SDO objects are transferred.

With an overall reset the slave and module parameters are not reset!

⇒ You can take your application into operation now.



CAUTION!

Please always observe the safety instructions for your drive, especially during commissioning!

2. ➔ Before an axis can be controlled, it must be initialized. To do this, call the *Init* block FB 873 - VMC_InitSigma7S_EC with *Enable* = TRUE.
 - ⇒ The output *Valid* returns TRUE. In the event of a fault, you can determine the error by evaluating the *ErrorID*.

You have to call the *Init* block again if you load a new axis DB or you have changed parameters on the *Init* block.



Do not continue until the Init block does not report any errors!

3. ➔ Ensure that the *Kernel* block FB 872 - VMC_KernelSigma7_EC is called cyclically. In this way, control signals are transmitted to the drive and status messages are reported.
4. ➔ Program your application with the FB 860 - VMC_AxisControl or with the PLCopen blocks.

Controlling the drive via HMI

There is the possibility to control your drive via HMI. For this, a predefined symbol library is available for Movicon to access the VMC_AxisControl function block. ↪ [Chap. 13.8 'Controlling the drive via HMI' page 613](#)

13.2.2.4.4 Copy project

Proceeding

In the example, the station 'Source' is copied and saved as 'Target'.

1. ➔ Open the hardware configuration of the 'Source' CPU and start the *SPEED7 EtherCAT Manager*.
2. ➔ In the *SPEED7 EtherCAT Manager*, via 'File → Save as' save the configuration in your working directory.

3. ➤ Close the *SPEED7 EtherCAT Manager* and the hardware configurator.
4. ➤ Copy the station 'Source' with Ctrl + C and paste it as 'Target' into your project with Ctrl + V.
5. ➤ Select the 'Blocks' directory of the 'Target' CPU and delete the 'System data'.
6. ➤ Open the hardware configuration of the 'Target' CPU. Adapt the IP address data or re-network the CPU or the CP again.



Before calling the SPEED7 EtherCAT Manager you have always to save your project with 'Station → Save and compile'.

7. ➤ Save your project with 'Station → Save and compile'.
8. ➤ Open the *SPEED7 EtherCAT Manager*.
9. ➤ Use 'File → Open' to load the configuration from your working directory.
10. ➤ Close the *SPEED7 EtherCAT Manager*.
11. ➤ Save and compile your configuration.

13.2.2.5 Drive specific blocks



The PLCopen blocks for axis control can be found here: [🔗 Chap. 13.7 'Blocks for axis control' page 542](#)

13.2.2.5.1 UDT 872 - VMC_ConfigSigma7EC_REF - Sigma-7 EtherCAT Data structure axis configuration

This is a user-defined data structure that contains information about the configuration data. The UDT is specially adapted to the use of a *Sigma-7* drive, which is connected via EtherCAT.

13.2.2.5.2 FB 872 - VMC_KernelSigma7_EC - Sigma-7 EtherCAT Kernel

Description

This block converts the drive commands for a *Sigma-7* axis via EtherCAT and communicates with the drive. For each *Sigma-7* axis, an instance of this FB is to be cyclically called.



Please note that this module calls the SFB 238 internally.

In the SPEED7 Studio, this module is automatically inserted into your project.

In Siemens SIMATIC Manager, you have to copy the SFB 238 from the Motion Control Library into your project.

Parameter	Declaration	Data type	Description
Init	INPUT	BOOL	The block is internally reset with an edge 0-1. Existing motion commands are aborted and the block is initialized.
Config	IN_OUT	UDT872	Data structure for transferring axis-dependent configuration data to the <i>AxisKernel</i> .
Axis	IN_OUT	MC_AXIS_REF	Data structure for transferring axis-dependent information to the <i>AxisKernel</i> and PLCopen blocks.

13.2.2.5.3 FB 873 - VMC_InitSigma7S_EC - Sigma-7S EtherCAT Initialization

Description

This block is used to configure the axis. The module is specially adapted to the use of a *Sigma-7* drive, which is connected via EtherCAT.

Parameter	Declaration	Data type	Description
Config	IN_OUT	UDT872	Data structure for transferring axis-dependent configuration data to the <i>AxisKernel</i> .
Axis	IN_OUT	MC_AXIS_REF	Data structure for transferring axis-dependent information to the <i>AxisKernel</i> and PLCopen blocks.
Enable	INPUT	BOOL	Release of initialization
Logical address	INPUT	INT	Start address of the PDO input data

Parameter	Declaration	Data type	Description
InputsStartAddressPDO	INPUT	INT	Start address of the input PDOs
OutputsStartAddressPDO	INPUT	INT	Start address of the output PDOs
EncoderType	INPUT	INT	Encoder type <ul style="list-style-type: none"> ■ 1: Absolute encoder ■ 2: Incremental encoder
EncoderResolutionBits	INPUT	INT	Number of bits corresponding to one encoder revolution. Default: 20
FactorPosition	INPUT	REAL	Factor for converting the position of user units [u] into drive units [increments] and back. It's valid: $p_{[\text{increments}]} = p_{[u]} \times \text{FactorPosition}$ Please consider the factor which can be specified on the drive via the objects 0x2701: 1 and 0x2701: 2. This should be 1.
Velocity Factor	INPUT	REAL	Factor for converting the speed of user units [u/s] into drive units [increments/s] and back. It's valid: $v_{[\text{increments/s}]} = v_{[u/s]} \times \text{FactorVelocity}$ Please also take into account the factor which you can specify on the drive via objects 0x2702: 1 and 0x2702: 2. This should be 1.
FactorAcceleration	INPUT	REAL	Factor to convert the acceleration of user units [u/s ²] in drive units [10 ⁻⁴ x increments/s ²] and back. It's valid: $10^{-4} \times a_{[\text{increments/s}^2]} = a_{[u/s^2]} \times \text{FactorAcceleration}$ Please also take into account the factor which you can specify on the drive via objects 0x2703: 1 and 0x2703: 2. This should be 1.
OffsetPosition	INPUT	REAL	Offset for the zero position [u].
MaxVelocityApp	INPUT	REAL	Maximum application speed [u/s]. The command inputs are checked to the maximum value before execution.
MaxAccelerationApp	INPUT	REAL	Maximum acceleration of application [u/s ²]. The command inputs are checked to the maximum value before execution.
MaxDecelerationApp	INPUT	REAL	Maximum application delay [u/s ²]. The command inputs are checked to the maximum value before execution.
MaxPosition	INPUT	REAL	Maximum position for monitoring the software limits [u].
MinPosition	INPUT	REAL	Minimum position for monitoring the software limits [u].
EnableMaxPosition	INPUT	BOOL	Monitoring maximum position <ul style="list-style-type: none"> ■ TRUE: Activates the monitoring of the maximum position.
EnableMinPosition	INPUT	BOOL	Monitoring minimum position <ul style="list-style-type: none"> ■ TRUE: Activation of the monitoring of the minimum position.

Parameter	Declaration	Data type	Description
MinUserPosition	OUTPUT	REAL	Minimum user position based on the minimum encoder value of 0x80000000 and the <i>FactorPosition</i> [u].
MaxUserPosition	OUTPUT	REAL	Maximum user position based on the maximum encoder value of 0x7FFFFFFF and the <i>FactorPosition</i> [u].
Valid	OUTPUT	BOOL	Initialization <ul style="list-style-type: none"> ■ TRUE: Initialization is valid.
Error	OUTPUT	BOOL	<ul style="list-style-type: none"> ■ Error <ul style="list-style-type: none"> – TRUE: An error has occurred. Additional error information can be found in the parameter <i>ErrorID</i>. The axis is disabled.
ErrorID	OUTPUT	WORD	Additional error information ↗ Chap. 13.10 'ErrorID - Additional error information' page 637

13.2.3 Usage Sigma-7W EtherCAT

13.2.3.1 Overview

Usage of the single-axis drive [↗ Chap. 13.2.2 'Usage Sigma-7S EtherCAT' page 324](#)

Precondition

- SPEED7 Studio from V1.6.1
or
- Siemens SIMATIC Manager from V 5.5, SP2 & *SPEED7 EtherCAT Manager & Simple Motion Control Library*
- CPU with EtherCAT master, e.g. CPU 015-CEFNR00
- *Sigma-7W* Double-axis drive with EtherCAT option card

Steps of configuration

- Set the parameters on the drive
 - The setting of the parameters happens by means of the software tool *Sigma Win+*.
- Hardware configuration in *VIPA SPEED7 Studio* or Siemens SIMATIC Manager
 - Configuring a CPU with EtherCAT master functionality
 - Configuration of the *Sigma-7W* EtherCAT double axes.
 - Configuring the EtherCAT connection via *SPEED7 EtherCAT Manager*
- Programming in *VIPA SPEED7 Studio* or Siemens SIMATIC Manager
 - *Init* block for the configuration of the double axes.
 - *Kernel* block for communication with one axis each.
 - Connecting the blocks for motion sequences.

13.2.3.2 Set the parameters on the drive

Parameter digits

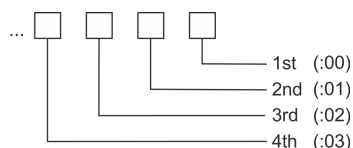
**CAUTION!**

Before the commissioning, you have to adapt your drive to your application with the *Sigma Win+* software tool! More may be found in the manual of your drive.

The following parameters must be set via *Sigma Win+* to match the *Simple Motion Control Library*:

Axis 1 - Module 1 (24bit encoder)

Servopack Parameter	Address:digit	Name	Value
Pn205	(2205h)	Multiturn Limit Setting	65535
Pn20E	(220Eh)	Electronic Gear Ratio (Numerator)	16
Pn210	(2210h)	Electronic Gear Ratio (Denominator)	1
PnB02	(2701h:01)	Position User Unit (Numerator)	1
PnB04	(2701h:02)	Position User Unit (Denominator)	1
PnB06	(2702h:01)	Velocity User Unit (Numerator)	1
PnB08	(2702h:02)	Velocity User Unit (Denominator)	1
PnB0A	(2703h:01)	Acceleration User Unit (Numerator)	1
PnB0C	(2703h:02)	Acceleration User Unit (Denominator)	1

Axis 2 - Module 2 (24Bit Encoder)

Servopack Parameter	Address:digit	Name	Value
Pn205	(2A05h)	Multiturn Limit Setting	65535
Pn20E	(2A0Eh)	Electronic Gear Ratio (Numerator)	16
Pn210	(2A10h)	Electronic Gear Ratio (Denominator)	1
PnB02	(2F01h:01)	Position User Unit (Numerator)	1
PnB04	(2F01h:02)	Position User Unit (Denominator)	1
PnB06	(2F02h:01)	Velocity User Unit (Numerator)	1
PnB08	(2F02h:02)	Velocity User Unit (Denominator)	1
PnB0A	(2F03h:01)	Acceleration User Unit (Numerator)	1
PnB0C	(2F03h:02)	Acceleration User Unit (Denominator)	1

13.2.3.3 Usage in VIPA SPEED7 Studio

13.2.3.3.1 Hardware configuration

Add CPU in the project

Please use for configuration the *SPEED7 Studio* V1.6.1 and up.

1. Start the *SPEED7 Studio*.

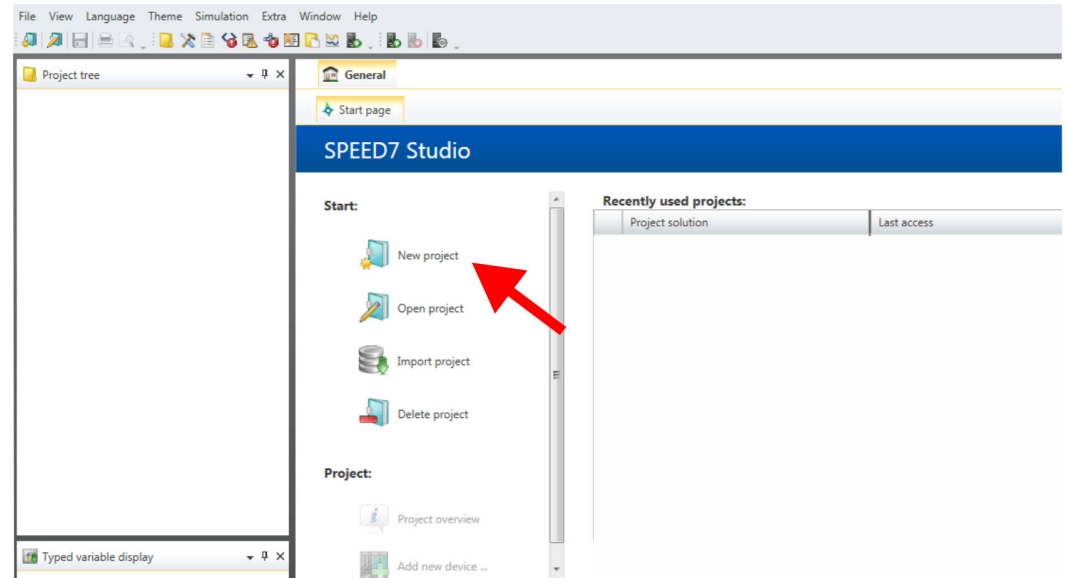

2. Create a new project at the start page with 'New project'.

⇒ A new project is created and the view 'Devices and networking' is shown.

3. Click in the *Project tree* at 'Add new device ...'.

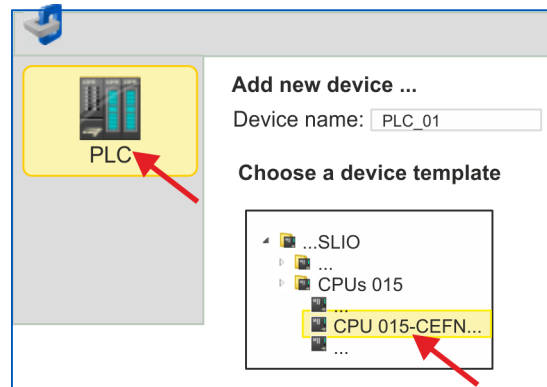
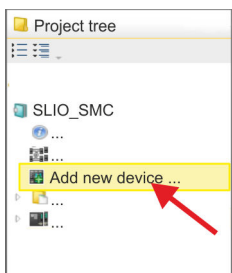

⇒ A dialog for device selection opens.

4. Select from the 'Device templates' a CPU with EtherCAT master functions such as CPU 015-CEFN00 and click at [OK].

⇒ The CPU is inserted in 'Devices and networking' and the 'Device configuration' is opened.

Activate motion control functions

If the EtherCAT master functionality is not yet activated on your CPU, the activation takes place as follows:

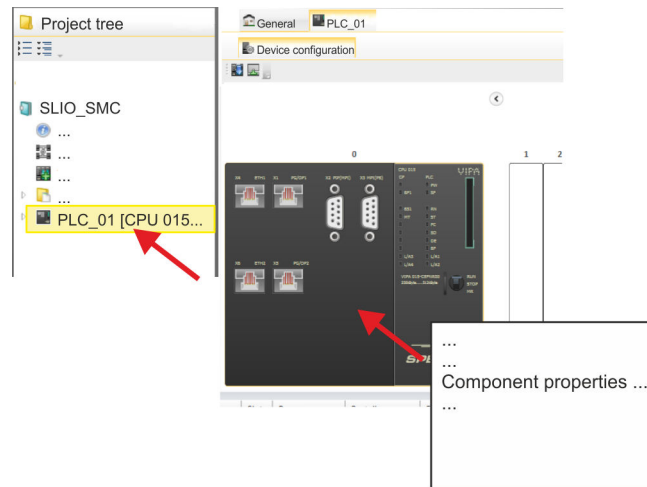

1. Click at the CPU in the 'Device configuration' and select 'Context menu' → 'Components properties'.

⇒ The properties dialog of the CPU is opened.

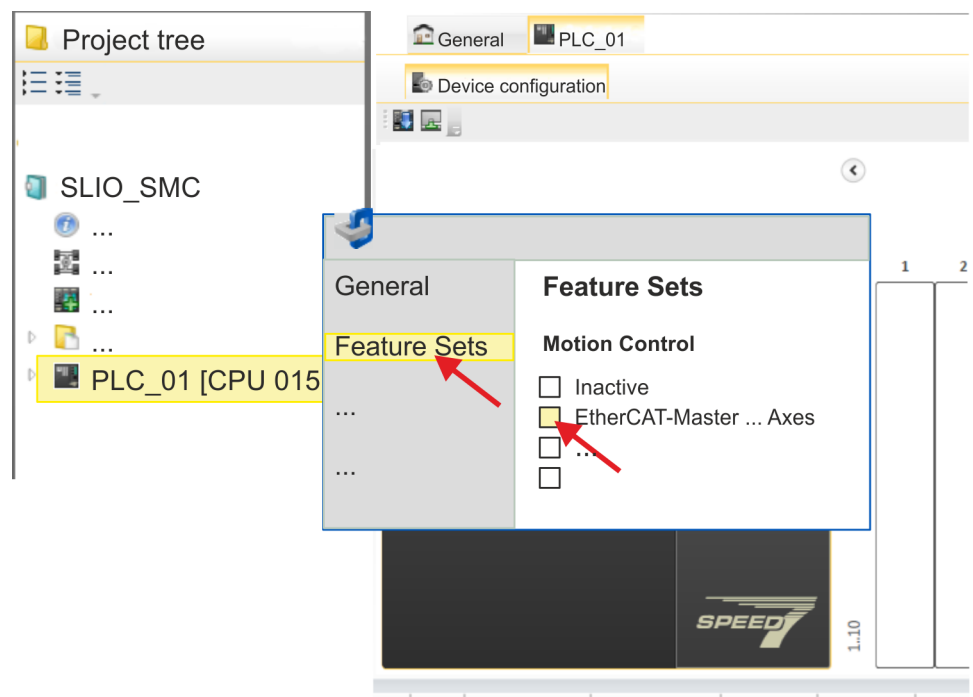

2. Click at 'Feature Sets' and activate at 'Motion Control' the parameter 'EtherCAT-Master... Axes'. The number of axes is not relevant in this example.

3. Confirm your input with [OK].

⇒ The motion control functions are now available in your project.



CAUTION!

Please note due to the system, with every change to the feature set settings, the EtherCAT field bus system and its motion control configuration will be deleted from your project!

Configuration of Ethernet PG/OP channel

1. Click in the *Project tree* at *'Devices and networking'*.
⇒ You will get a graphical object view of your CPU.

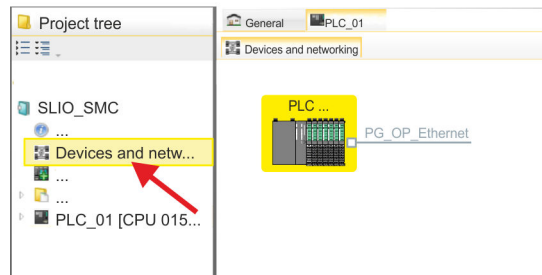

2. Click at the network *'PG_OP_Ethernet'*.
3. Select *'Context menu → Interface properties'*.
⇒ A dialog window opens. Here you can enter the IP address data for your Ethernet PG/OP channel. You get valid IP address parameters from your system administrator.
4. Confirm with [OK].
⇒ The IP address data are stored in your project listed in *'Devices and networking'* at *'Local components'*.
After transferring your project your CPU can be accessed via Ethernet PG/OP channel with the set IP address data.

Installing the ESI file

For the *Sigma-7* EtherCAT drive can be configured in the *SPEED7 EtherCAT Manager*, the corresponding ESI file must be installed. Usually, the *SPEED7 Studio* is delivered with current ESI files and you can skip this part. If your ESI file is not up-to date, you will find the latest ESI file for the *Sigma-7* EtherCAT drive under www.yaskawa.eu.com at *'Service → Drives & Motion Software'*.

1. Download the according ESI file for your drive. Unzip this if necessary.
2. Navigate to your *SPEED7 Studio*.
3. Open the corresponding dialog window by clicking on *'Extra → Install device description (EtherCAT - ESI)'*.
4. Under *'Source path'*, specify the ESI file and install it with [Install].
⇒ The devices of the ESI file are now available.

Sigma-7W add a double-axis drive

1. Click in the Project tree at *'Devices and networking'*.
2. Click here at *'EC-Mastersystem'* and select *'Context menu → Add new device'*.

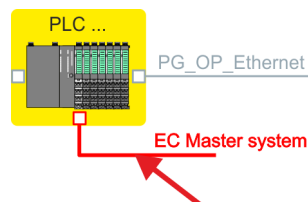

- ⇒ The device template for selecting an EtherCAT device opens.

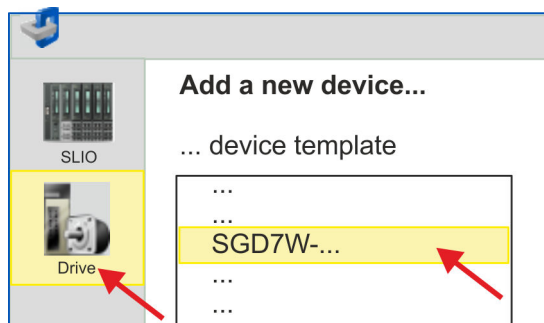

3. Select your *Sigma-7W* double-axis drive:

- SGD7W-xxxxA0 ...

Confirm your input with [OK]. If your drive does not exist, you must install the corresponding ESI file as described above.

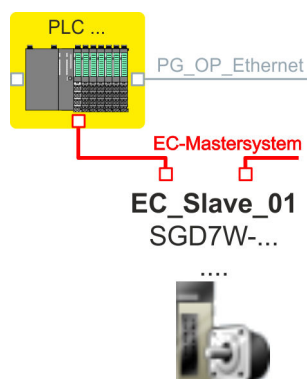

⇒ The *Sigma-7W* double-axis drive is connected to your EC master system.

Configure Sigma-7W double-axis drive

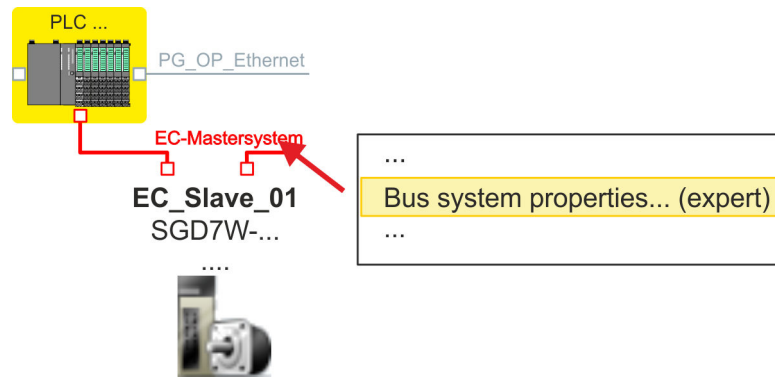

1. Click here at 'EC-Mastersystem' and select 'Context menu → Bus system properties (expert)'.

i You can only edit PDOs in 'Expert mode'! Otherwise, the buttons are hidden.

- ⇒ The SPEED7 EtherCAT Manager opens. Here you can configure the EtherCAT communication to your Sigma-7W double-axis drive.

More information about the usage of the SPEED7 EtherCAT Manager may be found in the online help of the SPEED7 Studio.

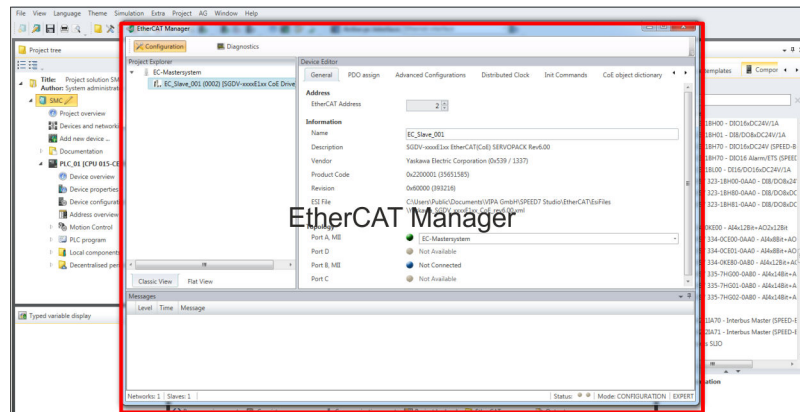

2. Click on the slave in the SPEED7 EtherCAT Manager and select the 'PDO assign' tab in the 'Device editor'.

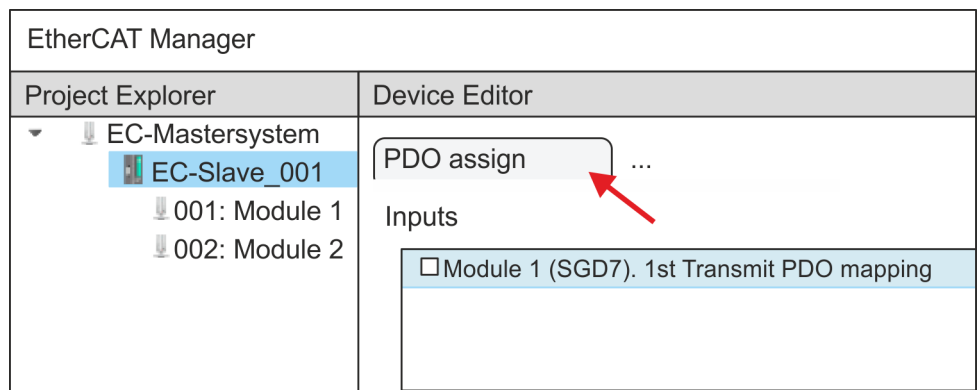

- ⇒ This dialogue shows a list of the PDOs for 'Module 1' (axis 1) and 'Module 2' (axis 2).

3. ➔ By selecting the appropriate mapping, you can edit the PDOs with [Edit]. Select the mapping 'Module 1 (SGD7). 1st Transmit PDO mapping' and click at [Edit].

 Please note that some PDOs can not be edited because of the default settings. By de-activating already activated PDOs, you can release the processing of locked PDOs.

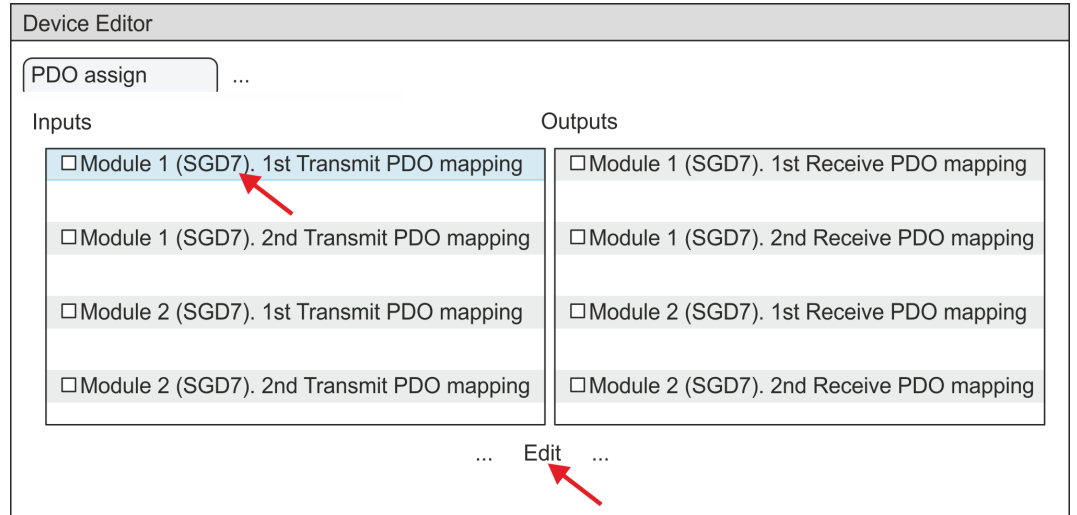

- ⇒ The dialog 'Edit PDO' is opened. Please check the PDO settings listed here and adjust them if necessary. Please also take into account the order of the 'Entries' and add them accordingly.

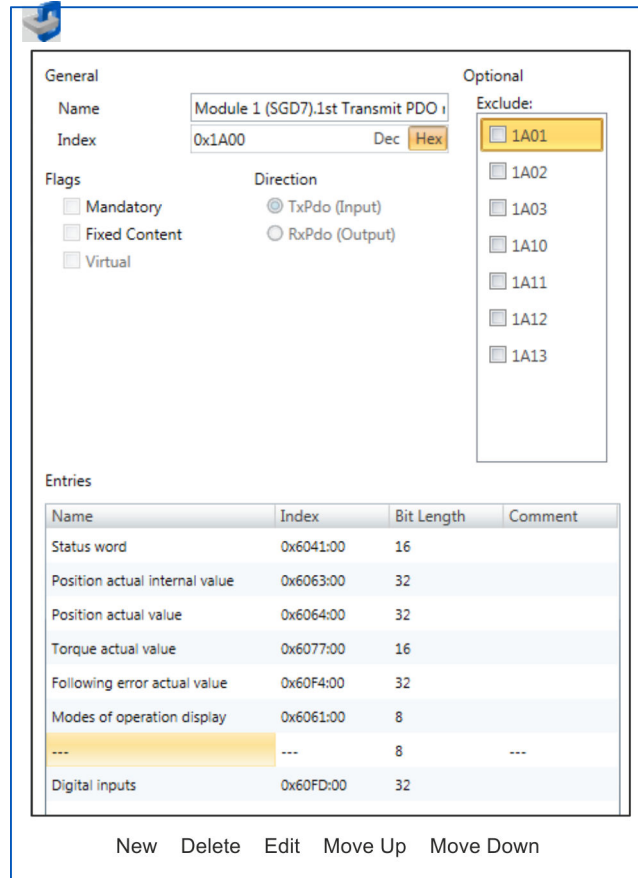

The following functions are available for editing the 'Entries':

- New
 - Here you can create a new entry in a dialog by selecting the corresponding entry from the '*CoE object dictionary*' and making your settings. The entry is accepted with [OK] and is listed in the list of entries.
- Delete
 - This allows you to delete a selected entry.
- Edit
 - This allows you to edit the general data of an entry.
- Move Up/Down
 - This allows you to move the selected entry up or down in the list.

4. ➔ Perform the following settings for the Transmit PDOs:

Inputs: 1st Transmit PDO

Module 1 (SGD7). 1st Transmit PDO mapping	Module 2 (SGD7). 1st Transmit PDO mapping
Name: Module 1 (SGD7). 1st Transmit PDO mapping	Name: Module 2 (SGD7). 1st Transmit PDO mapping
Index: 0x1A00	Index: 0x1A10
Flags: Everything de-activated	
Direction TxPdo (Input): activated	
Exclude: 1A01: de-activated	1A11: de-activated
Please note these settings, otherwise the PDO mappings can not be activated at the same time!	

Entries	Module 1 (axis 1)	Module 2 (axis 2)	Bit length
Name	Index	Index	
Status word	0x6041:00	0x6841: 00	16bit
Position actual internal value	0x6063:00	0x6863:00	32bit
Position actual value	0x6064:00	0x6864:00	32bit
Torque actual value	0x6077:00	0x6877:00	16bit
Following error actual value	0x60F4:00	0x68F4:00	32bit
Modes of operation display	0x6061:00	0x6861:00	8bit
---	---	---	8bit
Digital inputs	0x60FD:00	0x68FD:00	32bit

Inputs: 2nd Transmit PDO

Module 1 (SGD7). 2nd Transmit PDO mapping	Module 2 (SGD7). 2nd Transmit PDO mapping
Name: Module 1 (SGD7). 2nd Transmit PDO mapping	Name: Module 2 (SGD7). 2nd Transmit PDO mapping
Index: 0x1A01	Index: 0x1A11
Flags: Everything de-activated	
Direction TxPdo (Input): activated	
Exclude: 1A00, 1A02, 1A03: de-activated	1A10, 1A12, 1A13: de-activated
Please note these settings, otherwise the PDO mappings can not be activated at the same time!	

Entries	Module 1 (axis 1)	Module 2 (axis 2)	Bit length
Name	Index	Index	
Touch probe status	0x60B9:00	0x68B9:00	16bit
Touch probe 1 position value	0x60BA:00	0x68BA:00	32bit
Touch probe 2 position value	0x60BC:00	0x68BC:00	32bit
Velocity actual value	0x606C:00	0x686C:00	32bit

5. ➤ Perform the following settings for the Receive PDOs:

Outputs: 1st Receive PDO

Module 1 (SGD7). 1st Receive PDO	Module 2 (SGD7). 1st Receive PDO
Name: Module 1 (SGD7). 1st Receive PDO mapping	Name: Module 2 (SGD7). 1st Receive PDO mapping
Index: 0x1600	Index: 0x1610
Flags: Everything de-activated	
Direction RxPdo (Output): activated	
Exclude: 1601, 1602, 1603: de-activated	1611, 1612, 1613: de-activated
Please note these settings, otherwise the PDO mappings can not be activated at the same time!	

Entries	Module 1 (axis 1)	Module 2 (axis 2)	Bit length
Name	Index	Index	
Control word	0x6040:00	0x6840: 00	16bit
Target position	0x607A:00	0x687A: 00	32bit
Target velocity	0x60FF:00	0x68FF: 00	32bit
Modes of operation	0x6060:00	0x6860: 00	8bit
---	---	---	8bit
Touch probe function	0x60B8:00	0x68B8: 00	16bit

Outputs: 2nd Receive PDO

Module 1 (SGD7). 2nd Receive PDO	Module 2 (SGD7). 2nd Receive PDO
Name: Module 1 (SGD7). 2nd Receive PDO mapping	Name: Module 2 (SGD7). 2nd Receive PDO mapping
Index: 0x1601	Index: 0x1611
Flags: Everything de-activated	
Direction RxPdo (Output): activated	
Exclude: 1600, 1602, 1603: de-activated	1610, 1612, 1613: de-activated
Please note these settings, otherwise the PDO mappings can not be activated at the same time!	

Entries	Module 1 (axis 1)	Module 2 (axis 2)	Bit length
Name	Index	Index	
Profile velocity	0x6081:00	0x6881: 00	32bit
Profile acceleration	0x6083:00	0x6883: 00	32bit
Profile deceleration	0x6084:00	0x6884: 00	32bit

6. ➔ For 'Module 1' and 'Module 2' in PDO assignment, activate the PDOs 1 and 2 for the inputs and outputs. All subsequent PDOs must remain de-activated. If this is not possible, please check the respective PDO parameter 'Exclude'.

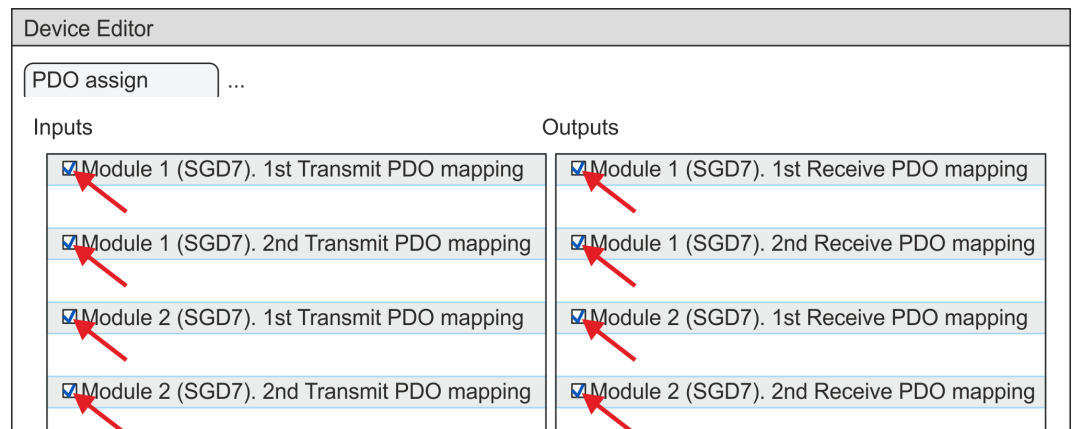

7. ➔ In the 'Device Editor' of the SPEED7 EtherCAT Manager, select the 'Distributed clocks' tab and set 'DC unused' as 'Operating mode'.

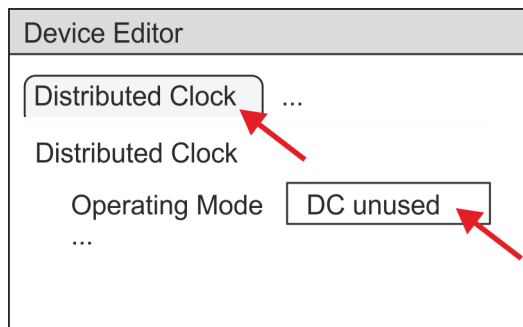

8. ➔ Select the 'Process image' tab in the 'device editor' using the arrow key and note the following PDO start addresses for the parameters of the block FB 874 - VMC_InitSigma7W_EC:

- Module 1: 'S7 Input address' → 'M1_PdoInputs' (here 0)
- Module 2: 'S7 Input address' → 'M2_PdoInputs' (here 36)
- Module 1: 'S7 Output address' → 'M1_PdoOutputs' (here 0)
- Module 2: 'S7 Output address' → 'M2_PdoOutputs' (here 36)

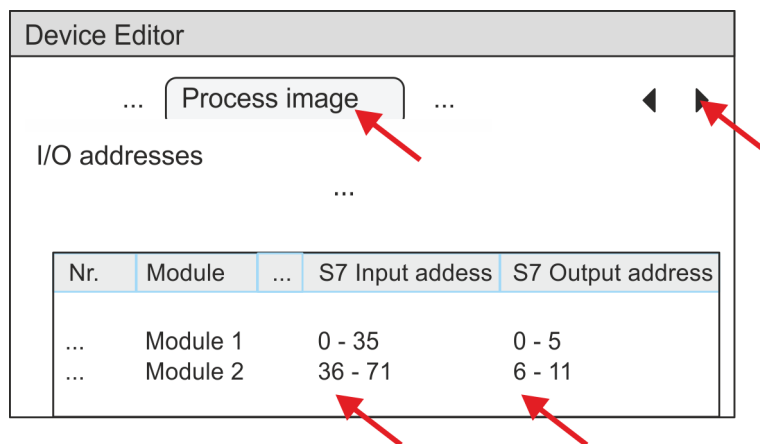

9. Click on 'EC-Mastersystem' in the *SPEED7 EtherCAT Manager* and select the 'Master' tab in the 'Device editor'.

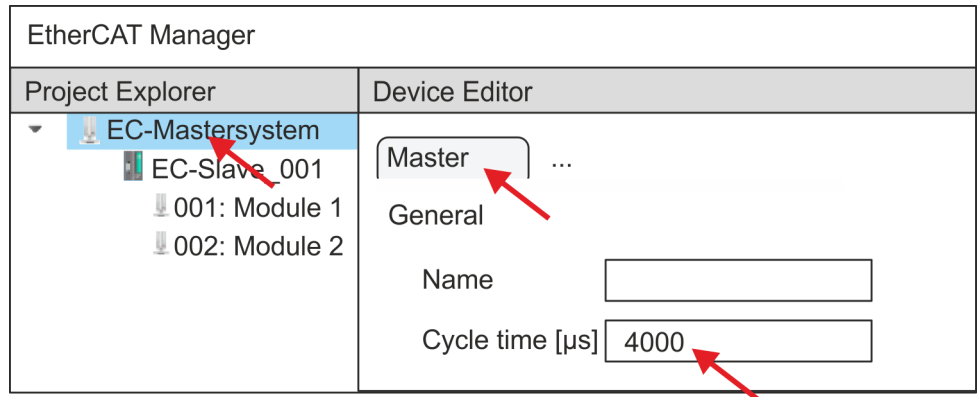

⇒ Set a cycle time of at least 4ms for Sigma-7W (400V) drives.

10. By closing the dialog of the *SPEED7 EtherCAT Manager* with [X] the configuration is taken to the *SPEED7 Studio*.

13.2.3.3.2 User program

Program structure

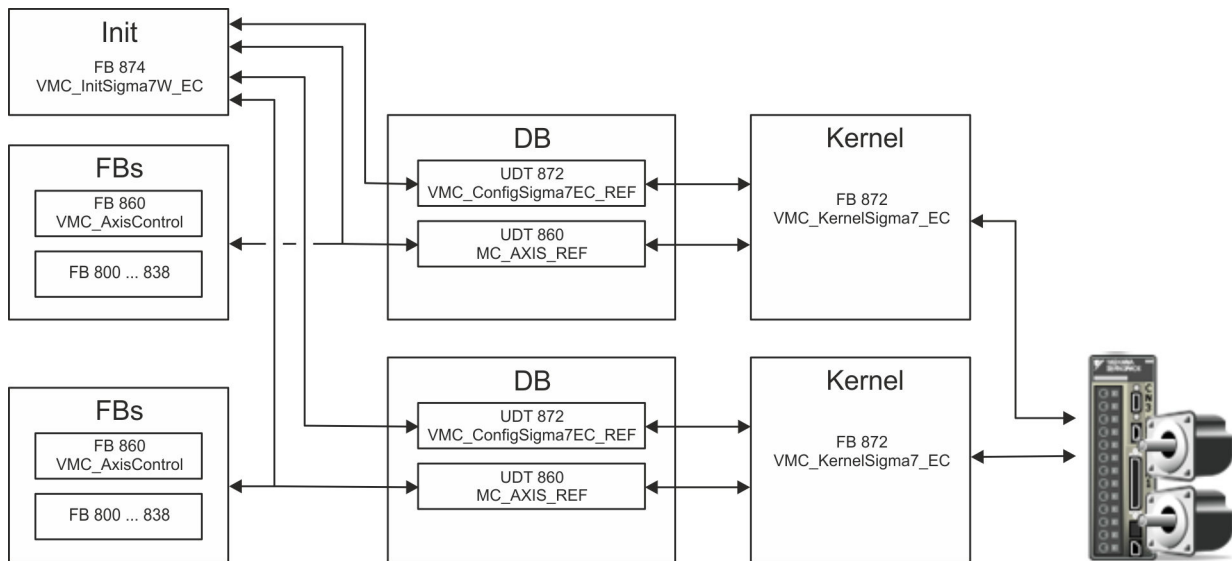

- DB
 - A data block (axis DB) for configuration and status data must be created for each axis of a drive. The data block consists of the following data structures:
 - UDT 872 - *VMC_ConfigSigma7EC_REF*
The data structure describes the structure of the configuration of the drive. Specific data structure for *Sigma-7* EtherCAT.
 - UDT 860 - *MC_AXIS_REF*
The data structure describes the structure of the parameters and status information of drives. General data structure for all drives and bus systems.
- FB 874 - *VMC_InitSigma7W_EC*
 - The *Init* block is used to configure the double-axis drive.
 - Specific block for *Sigma-7W* EtherCAT.
 - The configuration data for the initialization must be stored in the *axis DB*.
- FB 872 - *VMC_KernelSigma7_EC*
 - The *Kernel* block communicates with the drive via the appropriate bus system, processes the user requests and returns status messages.
 - The FB 872 - *VMC_KernelSigma7_EC* must be called for each axis.
 - Specific block for *Sigma-7* EtherCAT.
 - The exchange of the data takes place by means of the *axis DB*.
- FB 860 - *VMC_AxisControl*
 - General block for all drives and bus systems.
 - The FB 860 - *VMC_AxisControl* must be called for each axis.
 - Supports simple motion commands and returns all relevant status messages.
 - The exchange of the data takes place by means of the *axis DB*.
 - For motion control and status query, via the instance data of the block you can link a visualization.
 - In addition to the FB 860 - *VMC_AxisControl*, *PLCopen* blocks can be used.
- FB 800 ... FB 838 - *PLCopen*
 - The *PLCopen* blocks are used to program motion sequences and status queries.
 - The *PLCopen* blocks must be called for each axis.

Programming

Copy blocks into project

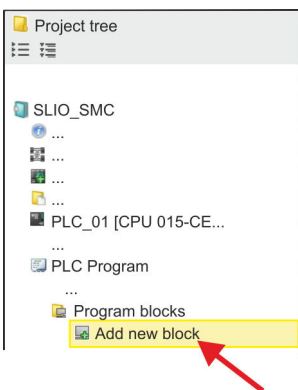

1. Click in the *Project tree* within the CPU at '*PLC program*', '*Program blocks*' at '*Add New block*'.

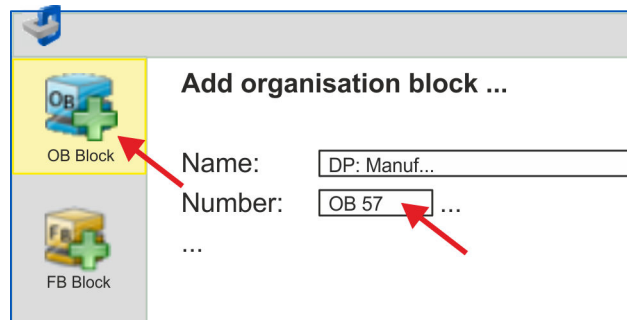

⇒ The dialog '*Add block*' is opened.

2. Select the block type '*OB block*' and add one after the other OB 57, OB 82 and OB 86 to your project.

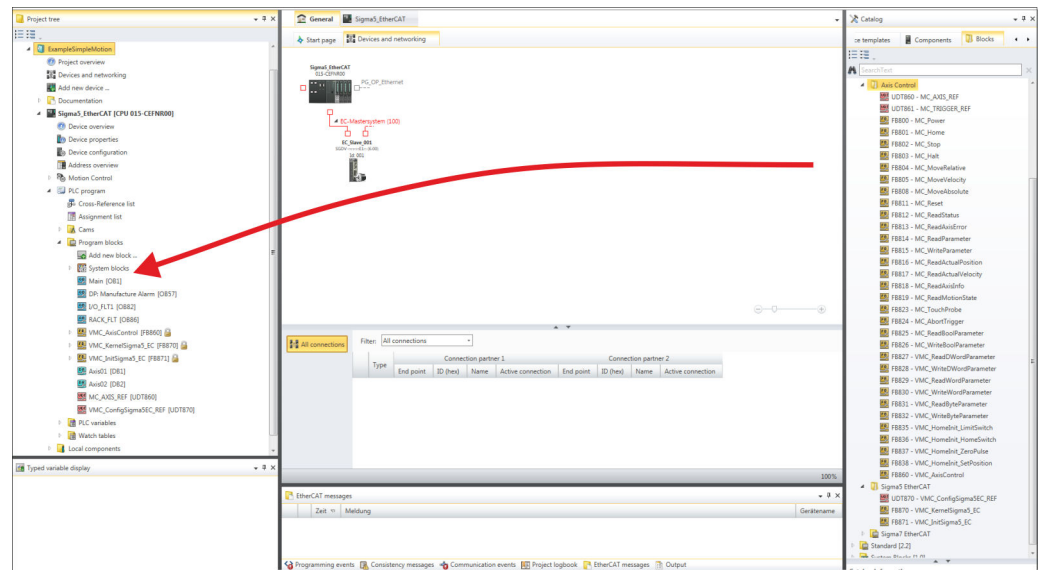

3. In the 'Catalog', open the 'Simple Motion Control' library at 'Blocks' and drag and drop the following blocks into 'Program blocks' of the Project tree:

- Sigma-7 EtherCAT:
 - UDT 872 - VMC_ConfigSigma7EC_REF
 - FB 872 - VMC_KernelSigma7_EC
 - FB 874 - VMC_InitSigma7W_EC
- Axis Control
 - UDT 860 - MC_AXIS_REF
 - Blocks for your movement sequences

Create axis DB for 'Module 1'

1. Add a new DB as your *axis DB* to your project. Click in the *Project tree* within the CPU at 'PLC program', 'Program blocks' at 'Add New block', select the block type 'DB block' and assign the name "Axis01" to it. The DB number can freely be selected such as DB 10.

⇒ The block is created and opened.

2. ■ In "Axis01", create the variable "Config" of type UDT 872. These are specific axis configuration data.
- In "Axis01", create the variable "Axis" of type UDT 860. During operation, all operating data of the axis are stored here.

Axis01 [DB10]
Data block structure

Addr...	Name	Data type	...
...	Config	UDT	[872]
...	Axis	UDT	[860]

Create axis DB for 'Module 2'

1. Add another DB as your *axis DB* to your project and assign it the name "Axis02". The DB number can freely be selected such as DB 11.

⇒ The block is created and opened.

2. 
 - In "Axis02", create the variable "Config" of type UDT 872. These are specific axis configuration data.
 - In "Axis02", create the variable "Axis" of type UDT 860. During operation, all operating data of the axis are stored here.

Axis02 [DB11]

Data block structure

	Addr...	Name	Data type	...
	...	Config	UDT	[872]
	...	Axis	UDT	[860]

OB 1

Configuration of the double-axis

Open OB 1 and program the following FB calls with associated DBs:

→ FB 874 - VMC_InitSigma7W_EC, DB 874 ↪ Chap. 13.2.3.5.3 'FB 874 - VMC_InitSigma7W_EC - Sigma-7W EtherCAT Initialization' page 401

At M1/M2_PdoInputs respectively M1/M2_PdoOutputs, enter the address from the SPEED7 EtherCAT Manager for the according axis. ↪ 374

```
⇒ CALL "VMC_InitSigma7W_EC" , "DI_InitSgm7WETC01"
  Enable                :=TRUE
  LogicalAddress        :=0
  M1_PdoInputs          :=0 (EtherCAT-Manager
                           Module1: S7 Input address)

  M1_PdoOutputs         :=0 (EtherCAT-Manager
                           Module1: S7 Output address)

  M1_EncoderType        :=2
  M1_EncoderResolutionBits :=20
  M1_FactorPosition     :=1.048576e+006
  M1_FactorVelocity     :=1.048576e+006
  M1_FactorAcceleration :=1.048576e+002
  M1_OffsetPosition     :=0.000000e+000
  M1_MaxVelocityApp     :=5.000000e+001
  M1_MaxAccelerationApp :=1.000000e+002
  M1_MaxDecelerationApp :=1.000000e+002
  M1_MaxVelocityDrive   :=6.000000e+001
  M1_MaxAccelerationDrive :=1.500000e+002
  M1_MaxDecelerationDrive :=1.500000e+002
  M1_MaxPosition        :=1.048500e+003
  M1_MinPosition        :=-1.048514e+003
  M1_EnableMaxPosition  :=TRUE
  M1_EnableMinPosition  :=TRUE
  M2_PdoInputs          :=36 (EtherCAT-Manager
                           Module2: S7 Input address)

  M2_PdoOutputs         :=36 (EtherCAT-Manager
                           Module2: S7 Output address)

  M2_EncoderType        :=2
  M2_EncoderResolutionBits :=20
  M2_FactorPosition     :=1.048576e+006
  M2_FactorVelocity     :=1.048576e+006
  M2_FactorAcceleration :=1.048576e+002
  M2_OffsetPosition     :=0.000000e+000
  M2_MaxVelocityApp     :=5.000000e+001
  M2_MaxAccelerationApp :=1.000000e+002
  M2_MaxDecelerationApp :=1.000000e+002
  M2_MaxVelocityDrive   :=6.000000e+001
  M2_MaxAccelerationDrive :=1.500000e+002
  M2_MaxDecelerationDrive :=1.500000e+002
  M2_MaxPosition        :=1.048500e+003
  M2_MinPosition        :=-1.048514e+003
  M2_EnableMaxPosition  :=TRUE
  M2_EnableMinPosition  :=TRUE
  M1_MinUserPosition    :=-1000.0
  M1_MaxUserPosition    :=1000.0
  M2_MinUserPosition    :=-1000.0
  M2_MaxUserPosition    :=1000.0
  Valid                 :="InitS7WEC1_Valid"
  Error                 :="InitS7WEC1_Error"
```

```

ErrorID                := "InitS7WEC1_ErrorID"
M1_Config              := "Axis01".Config
M1_Axis                := "Axis01".Axis
M2_Config              := "Axis02".Config
M2_Axis                := "Axis02".Axis

```

Connecting the kernel for the respective axis

The *Kernel* processes the user commands and passes them appropriately processed on to the drive via the respective bus system.

➔ FB 872 - VMC_KernelSigma7_EC, DB 872 for axis 1

FB 872 - VMC_KernelSigma7_EC, DB 1872 for axis 2 ↪ *Chap. 13.2.2.5.2 'FB 872 - VMC_KernelSigma7_EC - Sigma-7 EtherCAT Kernel' page 360*

```

⇒ CALL "VMC_KernelSigma7_EC" , DB 872
   Init := "KernelS7WEC1_Init"
   Config := "Axis01".Config
   Axis := "Axis01".Axis

CALL "VMC_KernelSigma7_EC" , DB 1872
   Init := "KernelS7WEC2_Init"
   Config := "Axis02".Config
   Axis := "Axis02".Axis

```

Connecting the block for motion sequences

For simplicity, the connection of the FB 860 - VMC_AxisControl is to be shown here. This universal block supports simple motion commands and returns status messages. The inputs and outputs can be individually connected. Please specify the reference to the corresponding axis data at 'Axis' in the axis DB.

→ FB 860 - VMC_AxisControl, DB 860 ↪ *Chap. 13.7.2.2 'FB 860 - VMC_AxisControl - Control block axis control' page 544*

```
⇒ CALL "VMC_AxisControl" , "DI_AxisControl01"
   AxisEnable           := "AxCtrl1_AxisEnable"
   AxisReset            := "AxCtrl1_AxisReset"
   HomeExecute          := "AxCtrl1_HomeExecute"
   HomePosition         := "AxCtrl1_HomePosition"
   StopExecute          := "AxCtrl1_StopExecute"
   MvVelocityExecute    := "AxCtrl1_MvVelExecute"
   MvRelativeExecute    := "AxCtrl1_MvRelExecute"
   MvAbsoluteExecute    := "AxCtrl1_MvAbsExecute"
   PositionDistance     := "AxCtrl1_PositionDistance"
   Velocity             := "AxCtrl1_Velocity"
   Acceleration         := "AxCtrl1_Acceleration"
   Deceleration         := "AxCtrl1_Deceleration"
   JogPositive          := "AxCtrl1_JogPositive"
   JogNegative          := "AxCtrl1_JogNegative"
   JogVelocity          := "AxCtrl1_JogVelocity"
   JogAcceleration     := "AxCtrl1_JogAcceleration"
   JogDeceleration     := "AxCtrl1_JogDeceleration"
   AxisReady           := "AxCtrl1_AxisReady"
   AxisEnabled          := "AxCtrl1_AxisEnabled"
   AxisError            := "AxCtrl1_AxisError"
   AxisErrorID         := "AxCtrl1_AxisErrorID"
   DriveWarning        := "AxCtrl1_DriveWarning"
   DriveError          := "AxCtrl1_DriveError"
   DriveErrorID        := "AxCtrl1_DriveErrorID"
   IsHomed             := "AxCtrl1_IsHomed"
   ModeOfOperation     := "AxCtrl1_ModeOfOperation"
   PLCopenState        := "AxCtrl1_PLCopenState"
   ActualPosition       := "AxCtrl1_ActualPosition"
   ActualVelocity       := "AxCtrl1_ActualVelocity"
   CmdDone             := "AxCtrl1_CmdDone"
   CmdBusy             := "AxCtrl1_CmdBusy"
   CmdAborted          := "AxCtrl1_CmdAborted"
   CmdError            := "AxCtrl1_CmdError"
   CmdErrorID          := "AxCtrl1_CmdErrorID"
   DirectionPositive    := "AxCtrl1_DirectionPos"
   DirectionNegative    := "AxCtrl1_DirectionNeg"
   SWLimitMinActive    := "AxCtrl1_SWLimitMinActive"
   SWLimitMaxActive    := "AxCtrl1_SWLimitMaxActive"
   HWLimitMinActive    := "AxCtrl1_HWLimitMinActive"
   HWLimitMaxActive    := "AxCtrl1_HWLimitMaxActive"
   Axis                 := "Axis..."_Axis
```

At Axis, enter "Axis01" for axis 1 and "Axis02" for axis 2.



For complex motion tasks, you can use the PLCopen blocks. Here you must also specify the reference to the corresponding axis data at Axis in the axis DB.

Your project now includes the following blocks:

- OB 1 - Main
- OB 57 - DP Manufacturer Alarm
- OB 82 - I/O_FLT1
- OB 86 - Rack_FLT

- FB 860 - VMC_AxisControl with instance DB
- FB 872 - VMC_KernelSigma7_EC with instance DB
- FB 874 - VMC_InitSigma7W_EC with instance DB
- UDT 860 - MC_Axis_REF
- UDT 872 - VMC_ConfigSigma7EC_REF

Sequence of operations

1. ➤ Select *'Project → Compile all'* and transfer the project into your CPU. You can find more information on the transfer of your project in the online help of the *SPEED7 Studio*.
 - ⇒ You can take your application into operation now.



CAUTION!

Please always observe the safety instructions for your drive, especially during commissioning!

2. ➤ Before the double-axis drive can be controlled, it must be initialized. To do this, call the *Init* block FB 874 - VMC_InitSigma7W_EC with *Enable* = TRUE.
 - ⇒ The output *Valid* returns TRUE. In the event of a fault, you can determine the error by evaluating the *ErrorID*.

You have to call the *Init* block again if you load a new axis DB or you have changed parameters on the *Init* block.



Do not continue until the Init block does not report any errors!

3. ➤ Ensure that the *Kernel* block FB 872 - VMC_KernelSigma7_EC is called cyclically for each axis. In this way, control signals are transmitted to the drive and status messages are reported.
4. ➤ Program your application with the FB 860 - VMC_AxisControl or with the PLCopen blocks for each axis.

Controlling the drive via HMI

There is the possibility to control your drive via HMI. For this, a predefined symbol library is available for Movicon to access the VMC_AxisControl function block. ↪ *Chap. 13.8 'Controlling the drive via HMI' page 613*

13.2.3.4 Usage in Siemens SIMATIC Manager







13.2.3.4.1 Precondition

Overview

- Please use for configuration the Siemens SIMATIC Manager V 5.5 SP2 and up.
- The configuration of the System SLIO CPU happens in the Siemens SIMATIC Manager by means of a virtual PROFINET IO device *'VIPA SLIO CPU'*. The *'VIPA SLIO CPU'* is to be installed in the hardware catalog by means of the GSDML.
- The configuration of the EtherCAT masters happens in the Siemens SIMATIC Manager by means of a virtual PROFINET IO device *'EtherCAT network'*. The *'EtherCAT network'* is to be installed in the hardware catalog by means of the GSDML.
- The *'EtherCAT network'* can be configured with the VIPA Tool *SPEED7 EtherCAT Manager*.
- For the configuration of the drive in the *SPEED7 EtherCAT Manager* the installation of the according ESI file is necessary.







**Installing the IO device
'VIPA SLIO System'**

The installation of the PROFINET IO device 'VIPA SLIO CPU' happens in the hardware catalog with the following approach:

1.  Go to the service area of www.vipa.com.
2.  Download the configuration file for your CPU from the download area via 'Config files → PROFINET'.
3.  Extract the file into your working directory.
4.  Start the Siemens hardware configurator.
5.  Close all the projects.
6.  Select 'Options → Install new GSD file'.
7.  Navigate to your working directory and install the according GSDML file.
 - ⇒ After the installation the according PROFINET IO device can be found at 'PROFINET IO → Additional field devices → I/O → VIPA SLIO System'.

**Installing the IO device
EtherCAT network**









The installation of the PROFINET IO devices 'EtherCAT Network' happens in the hardware catalog with the following approach:

1.  Go to the service area of www.vipa.com
2.  Load from the download area at 'Config files → EtherCAT' the GSDML file for your EtherCAT master.
3.  Extract the files into your working directory.
4.  Start the Siemens hardware configurator.
5.  Close all the projects.
6.  Select 'Options → Install new GSD file'.
7.  Navigate to your working directory and install the according GSDML file.
 - ⇒ After the installation the 'EtherCAT Network' can be found at 'PROFINET IO → Additional field devices → I/O → VIPA VIPA EtherCAT System'.

**Installing the SPEED7
EtherCAT Manager**

The configuration of the PROFINET IO device 'EtherCAT Network' happens by means of the *SPEED7 EtherCAT Manager* from VIPA. This may be found in the service area of www.vipa.com at 'Service/Support → Downloads → Software'.

The installation happens with the following proceeding:

1.  Close the Siemens SIMATIC Manager.
2.  Go to the service area of www.vipa.com
3.  Load the *SPEED7 EtherCAT Manager* and unzip it on your PC.
4.  For installation start the file *EtherCATManager_v... .exe*.
5.  Select the language for the installation.
6.  Accept the licensing agreement.
7.  Select the installation directory and start the installation.
8.  After installation you have to reboot your PC.
 - ⇒ The *SPEED7 EtherCAT Manager* is installed and can now be called via the context menu of the Siemens SIMATIC Manager.

13.2.3.4.2 Hardware configuration

Configuring the CPU in the project

Slot	Module
1	
2	CPU 315-2 PN/DP
X1	MPI/DP
X2	PN-IO
X2...	Port 1
X2...	Port 2
3	

To be compatible with the Siemens SIMATIC Manager the following steps should be executed:

1. Start the Siemens hardware configurator with a new project.
2. Insert a profile rail from the hardware catalog.
3. Place at 'Slot' number 2 the CPU 315-2 PN/DP (315-2EH14 V3.2).
4. The integrated PROFIBUS DP master (jack X3) is to be configured and connected via the sub module 'X1 MPI/DP'.
5. The integrated EtherCAT master is to be configured via the sub module 'X2 PN-IO' as a virtual PROFINET network.
6. Click at the sub module 'PN-IO' of the CPU.
7. Select 'Context menu → Insert PROFINET IO System'.

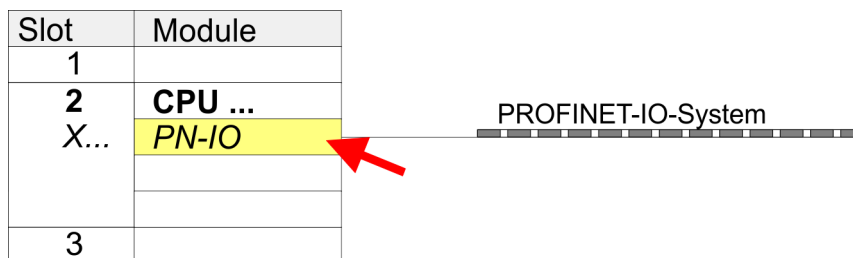

8. Create with [New] a new sub net and assign valid address data
9. Click at the sub module 'PN-IO' of the CPU and open with 'Context menu → Properties' the properties dialog.
10. Enter at 'General' a 'Device name'. The device name must be unique at the Ethernet subnet.

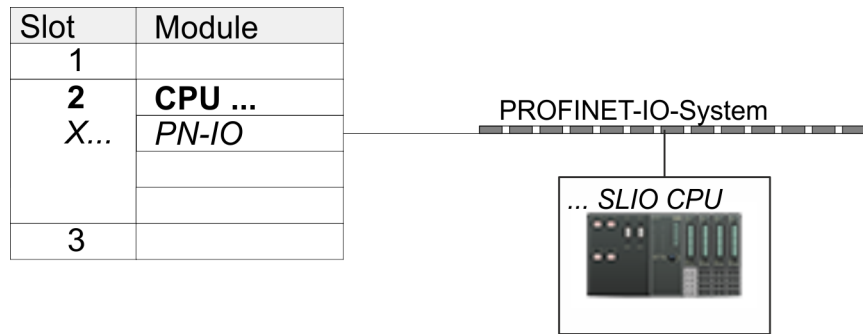

Slot	Module	Order number
0	... SLIO CPU ...	015-...
X2	015-...	
1		
2		
3		
...		

1. Navigate in the hardware catalog to the directory '*PROFINET IO*' → *Additional field devices* → *I/O* → *VIPA SLIO System*' and connect the IO device '*015-CFFNR00 CPU*' to your PROFINET system.
 - ⇒ In the Device overview of the PROFINET IO device '*VIPA SLIO CPU*' the CPU is already placed at slot 0. From slot 1 you can place your System SLIO modules.

Configuration of Ethernet PG/OP channel

Slot	Module
1	
2	CPU ...
X...	<i>PN-IO</i>
3	
4	343-1EX30
5	
...	

1. Place for the Ethernet PG/OP channel at slot 4 the Siemens CP 343-1 (SIMATIC 300 \ CP 300 \ Industrial Ethernet \ CP 343-1 \ 6GK7 343-1EX30 0XE0 V3.0).
2. Open the properties dialog by clicking on the CP 343-1EX30 and enter for the CP at '*Properties*' the IP address data. You get valid IP address parameters from your system administrator.
3. Assign the CP to a '*Subnet*'. The IP address data are not accepted without assignment!

Insert 'EtherCAT network'

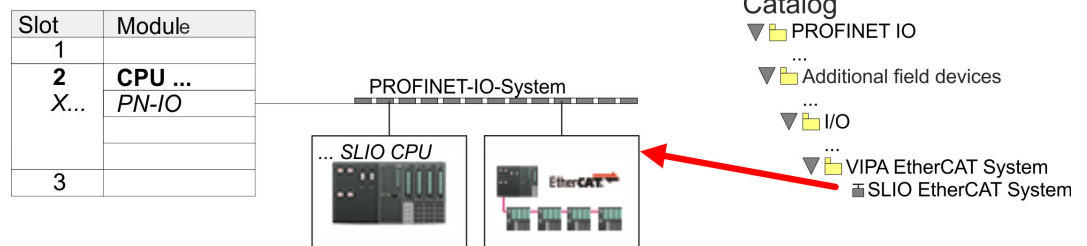

1. Navigate in the hardware catalog to the directory '*PROFINET IO*' → *Additional field devices* → *I/O* → *VIPA EtherCAT System*' and connect the IO device '*SLIO EtherCAT System*' to your PROFINET system.

- Click at the inserted IO device 'EtherCAT Network' and define the areas for in and output by drag and dropping the according 'Out' or 'In' area to a slot.

Create the following areas:

- In 128byte
- Out 128byte

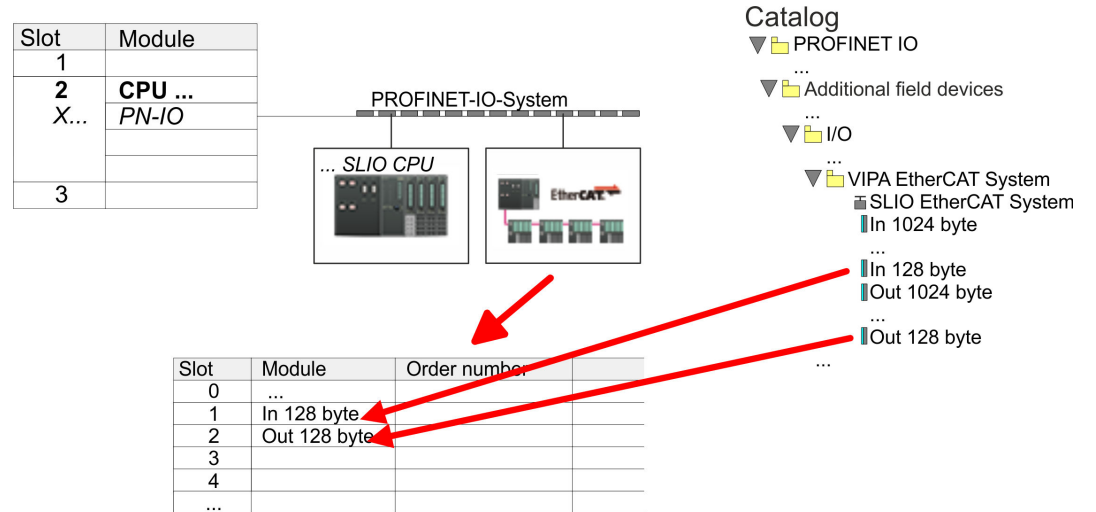

- Select 'Station → Save and compile'

Configure Sigma-7W EtherCAT double-axis drive

The double-axis drive is configured in the *SPEED7 EtherCAT Manager*.



Before calling the SPEED7 EtherCAT Manager you have always to save your project with 'Station → Save and compile'.

Slot	Module
1	
2	CPU ...
X...	PN-IO
3	

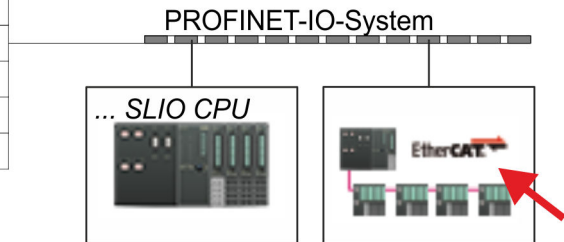

- Click at an inserted IO device 'EtherCAT Network' and select 'Context menu → Start Device-Tool → SPEED7 EtherCAT Manager'.

⇒ The SPEED7 EtherCAT Manager opens. Here you can configure the EtherCAT communication to your Sigma-7W EtherCAT double-axis drive.

More information about the usage of the SPEED7 EtherCAT Manager may be found in the according manual or online help.

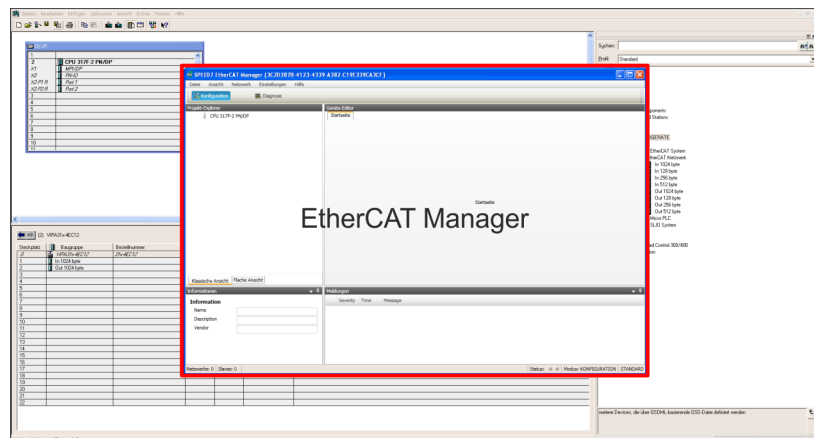

- For the Sigma-7W EtherCAT drive to be configured in the SPEED7 EtherCAT Manager, the corresponding ESI file must be installed. The ESI file for the Sigma-7W EtherCAT double-axis drive can be found under www.yaskawa.eu.com at 'Service → Drives & Motion Software'. Download the according ESI file for your drive. Unzip this if necessary.
- Open in the SPEED7 EtherCAT Manager via 'File → ESI Manager' the dialogue window 'ESI Manager'.
- In the 'ESI Manager' click at [Add File] and select your ESI file. With [Open], the ESI file is installed in the SPEED7 EtherCAT Manager.
- Close the 'ESI Manager'.

⇒ Your Sigma-7W EtherCAT double-axis drive is now available for configuration.

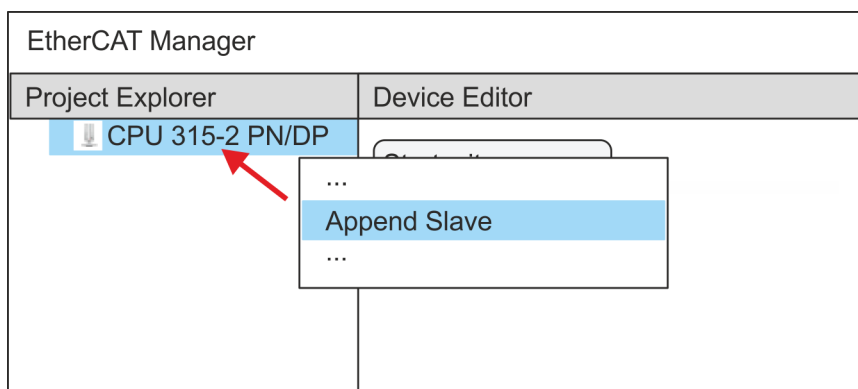

7. In the EtherCAT Manager, click on your CPU and open via 'Context menu' → 'Append Slave' the dialog box for adding an EtherCAT slave.
 - ⇒ The dialog window for selecting an EtherCAT slave is opened.
8. Select your *Sigma-7W* EtherCAT double-axis drive and confirm your selection with [OK].
 - ⇒ The *Sigma-7W* EtherCAT double-axis drive is connected to the master and can now be configured.

9.



You can only edit PDOs in 'Expert mode'! Otherwise, the buttons are hidden. By activating the 'Expert mode' you can switch to advanced setting.

By activating 'View → Expert' you can switch to the *Expert mode*.

10. Click on the *Sigma-7W* EtherCAT Slave in the *SPEED7 EtherCAT Manager* and select the 'PDO assign' tab in the 'Device editor'.

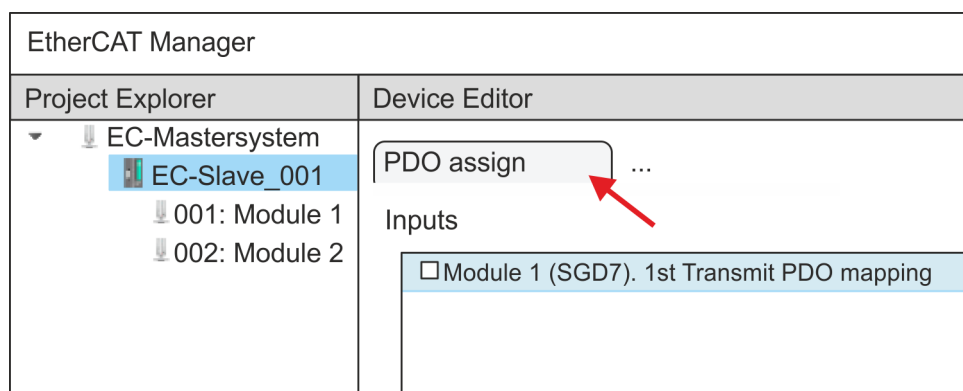

- ⇒ This dialogue shows a list of the PDOs.

11. ➔ By selecting the appropriate mapping, you can edit the PDOs with [Edit]. Select the mapping 'Module 1 (SGD7). 1st Transmit PDO mapping' and click at [Edit].

i Please note that some PDOs can not be edited because of the default settings. By de-activating already activated PDOs, you can release the processing of locked PDOs.

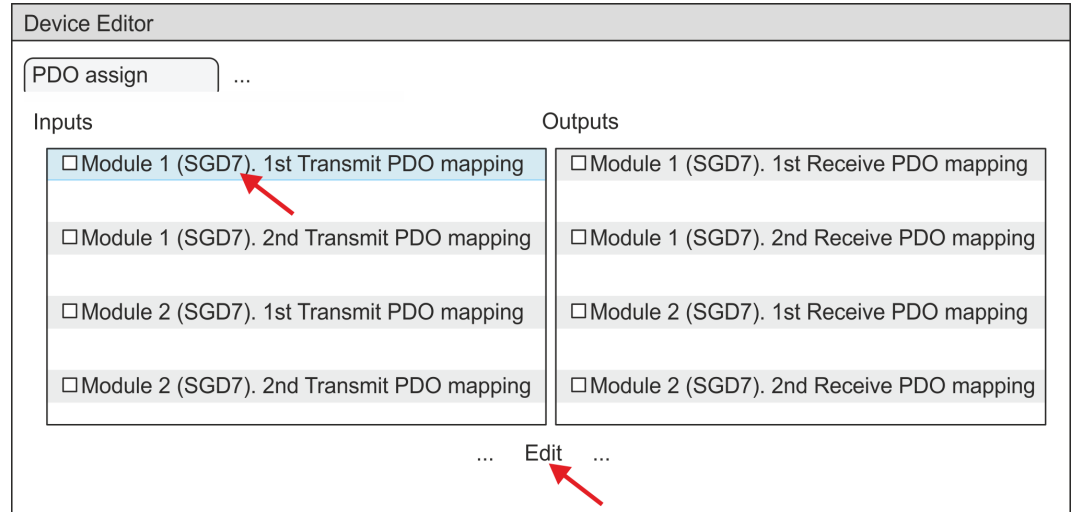

- ⇒ The dialog 'Edit PDO' is opened. Please check the PDO settings listed here and adjust them if necessary. Please also take into account the order of the 'Entries' and add them accordingly.

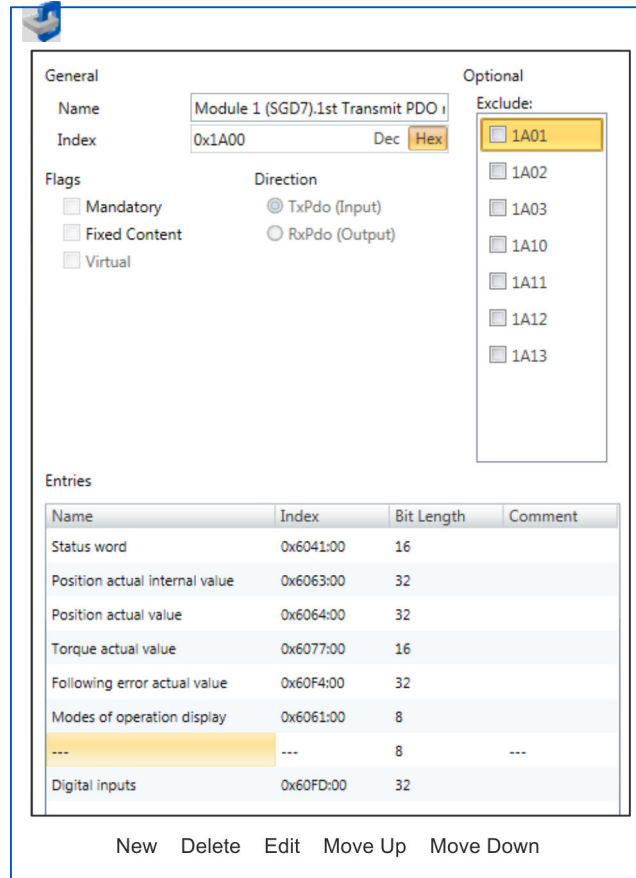

The following functions are available for editing the 'Entries':

- New
 - Here you can create a new entry in a dialog by selecting the corresponding entry from the 'CoE object dictionary' and making your settings. The entry is accepted with [OK] and is listed in the list of entries.
- Delete
 - This allows you to delete a selected entry.
- Edit
 - This allows you to edit the general data of an entry.
- Move Up/Down
 - This allows you to move the selected entry up or down in the list.

12. Perform the following settings for the Transmit PDOs:**Inputs: 1st Transmit PDO**

Module 1 (SGD7). 1st Transmit PDO mapping	Module 2 (SGD7). 1st Transmit PDO mapping
Name: Module 1 (SGD7). 1st Transmit PDO mapping	Name: Module 2 (SGD7). 1st Transmit PDO mapping
Index: 0x1A00	Index: 0x1A10
Flags: Everything de-activated	
Direction TxPdo (Input): activated	
Exclude: 1A01: de-activated	1A11: de-activated
Please note these settings, otherwise the PDO mappings can not be activated at the same time!	

Entries	Module 1 (axis 1)	Module 2 (axis 2)	Bit length
Name	Index	Index	
Status word	0x6041:00	0x6841: 00	16bit
Position actual internal value	0x6063:00	0x6863:00	32bit
Position actual value	0x6064:00	0x6864:00	32bit
Torque actual value	0x6077:00	0x6877:00	16bit
Following error actual value	0x60F4:00	0x68F4:00	32bit
Modes of operation display	0x6061:00	0x6861:00	8bit
---	---	---	8bit
Digital inputs	0x60FD:00	0x68FD:00	32bit

Inputs: 2nd Transmit PDO

Module 1 (SGD7). 2nd Transmit PDO mapping	Module 2 (SGD7). 2nd Transmit PDO mapping
Name: Module 1 (SGD7). 2nd Transmit PDO mapping	Name: Module 2 (SGD7). 2nd Transmit PDO mapping
Index: 0x1A01	Index: 0x1A11
Flags: Everything de-activated	
Direction TxPdo (Input): activated	
Exclude: 1A00, 1A02, 1A03: de-activated	1A10, 1A12, 1A13: de-activated
Please note these settings, otherwise the PDO mappings can not be activated at the same time!	

Entries	Module 1 (axis 1)	Module 2 (axis 2)	Bit length
Name	Index	Index	
Touch probe status	0x60B9:00	0x68B9:00	16bit
Touch probe 1 position value	0x60BA:00	0x68BA:00	32bit
Touch probe 2 position value	0x60BC:00	0x68BC:00	32bit
Velocity actual value	0x606C:00	0x686C:00	32bit

13. Perform the following settings for the Receive PDOs:**Outputs: 1st Receive PDO**

Module 1 (SGD7). 1st Receive PDO		Module 2 (SGD7). 1st Receive PDO	
Name: Module 1 (SGD7). 1st Receive PDO mapping		Name: Module 2 (SGD7). 1st Receive PDO mapping	
Index: 0x1600		Index: 0x1610	
Flags: Everything de-activated			
Direction RxPdo (Output): activated			
Exclude: 1601, 1602, 1603: de-activated		1611, 1612, 1613: de-activated	
Please note these settings, otherwise the PDO mappings can not be activated at the same time!			

Entries	Module 1 (axis 1)	Module 2 (axis 2)	Bit length
Name	Index	Index	
Control word	0x6040:00	0x6840: 00	16bit
Target position	0x607A:00	0x687A: 00	32bit
Target velocity	0x60FF:00	0x68FF: 00	32bit
Modes of operation	0x6060:00	0x6860:00	8bit
---	---	---	8bit
Touch probe function	0x60B8:00	0x68B8: 00	16bit

Outputs: 2nd Receive PDO

Module 1 (SGD7). 2nd Receive PDO		Module 2 (SGD7). 2nd Receive PDO	
Name: Module 1 (SGD7). 2nd Receive PDO mapping		Name: Module 2 (SGD7). 2nd Receive PDO mapping	
Index: 0x1601		Index: 0x1611	
Flags: Everything de-activated			
Direction RxPdo (Output): activated			
Exclude: 1600, 1602, 1603: de-activated		1610, 1612, 1613: de-activated	
Please note these settings, otherwise the PDO mappings can not be activated at the same time!			

Entries	Module 1 (axis 1)	Module 2 (axis 2)	Bit length
Name	Index	Index	
Profile velocity	0x6081:00	0x6881:00	32bit
Profile acceleration	0x6083:00	0x6883:00	32bit
Profile deceleration	0x6084:00	0x6884:00	32bit

14. For 'Module 1' and 'Module 2' in PDO assignment, activate the PDOs 1 and 2 for the inputs and outputs. All subsequent PDOs must remain de-activated. If this is not possible, please check the respective PDO parameter 'Exclude'.

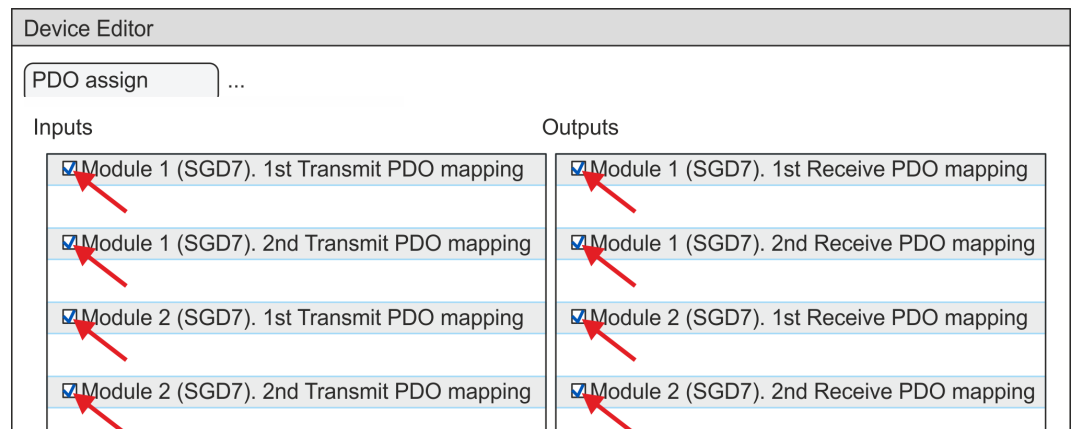

15. In the 'Device Editor' of the SPEED7 EtherCAT Manager, select the 'Distributed clocks' tab and set 'DC unused' as 'Operating mode'.

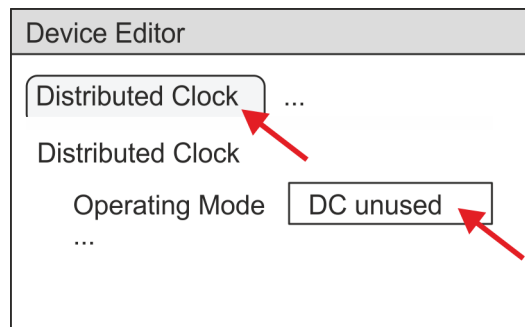

16. Select the 'Process image' tab in the 'device editor' using the arrow key and note the following PDO start addresses for the parameters of the block FB 874 - VMC_InitSigma7W_EC:

- Module 1: 'S7 Input address' → 'M1_PdoInputs' (here 0)
- Module 2: 'S7 Input address' → 'M2_PdoInputs' (here 36)
- Module 1: 'S7 Output address' → 'M1_PdoOutputs' (here 0)
- Module 2: 'S7 Output address' → 'M2_PdoOutputs' (here 36)

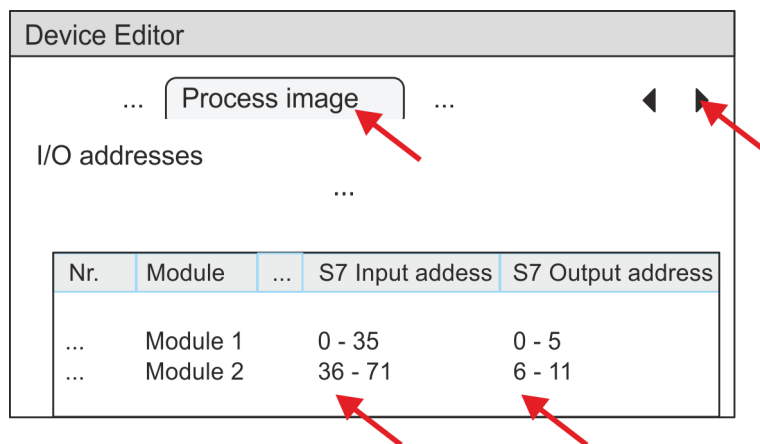

17. Click on your CPU in the *SPEED7 EtherCAT Manager* and select the 'Master' tab in the 'Device editor'.

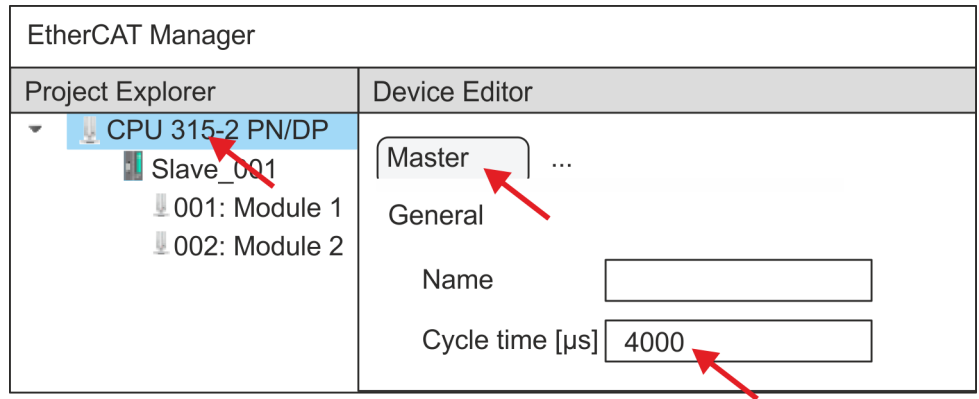

⇒ Set a cycle time of at least 4ms for Sigma-7W (400V) drives.

18. By closing the *SPEED7 EtherCAT Manager* the EtherCAT configuration is taken to the project. You can always edit your EtherCAT configuration in the *SPEED7 EtherCAT Manager*, since the configuration is stored in your project.
19. Save and compile your configuration.

13.2.3.4.3 User program

Program structure

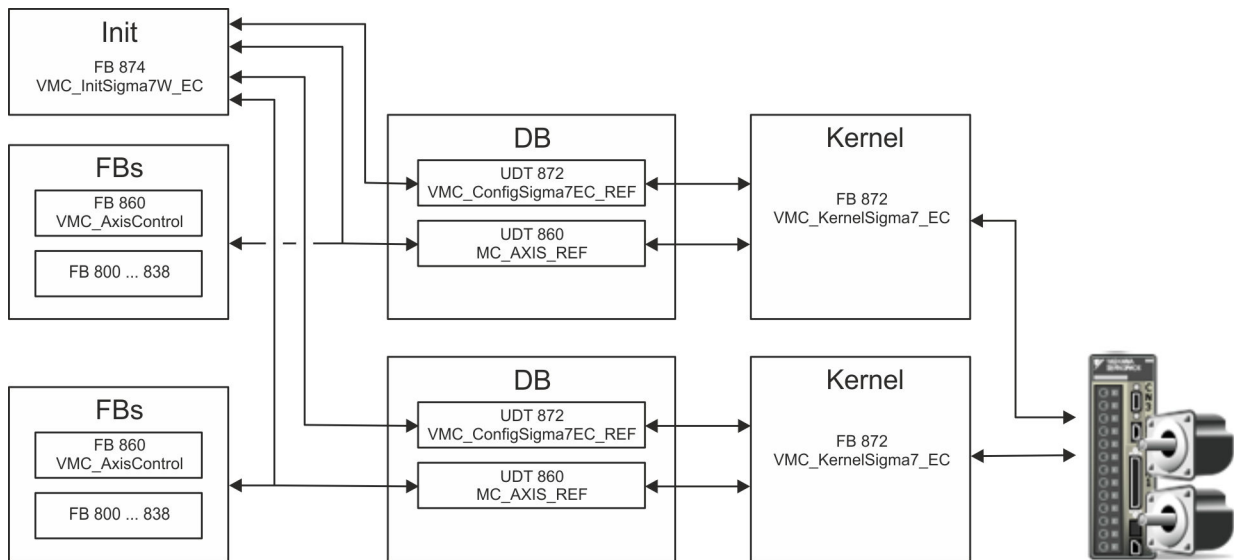

- DB

A data block (axis DB) for configuration and status data must be created for each axis of a drive. The data block consists of the following data structures:

 - UDT 872 - *VMC_ConfigSigma7EC_REF*
The data structure describes the structure of the configuration of the drive. Specific data structure for *Sigma-7* EtherCAT.
 - UDT 860 - *MC_AXIS_REF*
The data structure describes the structure of the parameters and status information of drives.
General data structure for all drives and bus systems.
- FB 874 - *VMC_InitSigma7W_EC*
 - The *Init* block is used to configure the double-axis drive.
 - Specific block for *Sigma-7W* EtherCAT.
 - The configuration data for the initialization must be stored in the *axis DB*.
- FB 872 - *VMC_KernelSigma7_EC*
 - The *Kernel* block communicates with the drive via the appropriate bus system, processes the user requests and returns status messages.
 - The FB 872 - *VMC_KernelSigma7_EC* must be called for each axis.
 - Specific block for *Sigma-7* EtherCAT.
 - The exchange of the data takes place by means of the *axis DB*.
- FB 860 - *VMC_AxisControl*
 - General block for all drives and bus systems.
 - The FB 860 - *VMC_AxisControl* must be called for each axis.
 - Supports simple motion commands and returns all relevant status messages.
 - The exchange of the data takes place by means of the *axis DB*.
 - For motion control and status query, via the instance data of the block you can link a visualization.
 - In addition to the FB 860 - *VMC_AxisControl*, *PLCopen* blocks can be used.
- FB 800 ... FB 838 - *PLCopen*
 - The *PLCopen* blocks are used to program motion sequences and status queries.
 - The *PLCopen* blocks must be called for each axis.

Programming

Include library

1. ➤ Go to the service area of www.vipa.com.
2. ➤ Download the *Simple Motion Control* library from the download area at '*VIPA Lib*'.
3. ➤ Open the dialog window for ZIP file selection via '*File* ➔ *Retrieve*'.
4. ➤ Select the according ZIP file and click at [Open].
5. ➤ Specify a target directory in which the blocks are to be stored and start the unzip process with [OK].

Copy blocks into project

- Open the library after unzipping and drag and drop the following blocks into '*Blocks*' of your project:
 - *Sigma-7W* EtherCAT:
 - UDT 872 - *VMC_ConfigSigma7EC_REF*
 - FB 872 - *VMC_KernelSigma7_EC*
 - FB 874 - *VMC_InitSigma7W_EC*
 - Axis Control
 - UDT 860 - *MC_AXIS_REF*
 - Blocks for your movement sequences

Create interrupt OBs

1. ➤ In your project, click at 'Blocks' and choose 'Context menu → Insert new object → Organization block'.
⇒ The dialog 'Properties Organization block' opens.
2. ➤ Add OB 57, OB 82, and OB 86 successively to your project.

Create axis DB for 'Module 1'

1. ➤ In your project, click at 'Blocks' and choose 'Context menu → Insert new object → Data block'.

Specify the following parameters:

- Name and type
 - The DB no. as 'Name' can freely be chosen, such as DB 10.
 - Set 'Shared DB' as the 'Type'.
- Symbolic name
 - Specify "Axis01".

Confirm your input with [OK].

⇒ The block is created.

2. ➤ Open DB 10 "Axis01" by double-click.
 - In "Axis01", create the variable "Config" of type UDT 872. These are specific axis configuration data.
 - In "Axis01", create the variable "Axis" of type UDT 860. During operation, all operating data of the axis are stored here.

DB10

Address	Name	Type	...
		Struct	
...	Config	"VMC_ConfigSigma7EC_REF"	
...	Axis	"MC_AXIS_REF"	
...		END_STRUCT	

Create axis DB for 'Module 2'

1. ➤ Add another DB as your *axis DB* to your project and assign it the name "Axis02". The DB number can freely be selected such as DB11.
⇒ The block is created.

2. ➤ Open DB 11 "Axis02" by double-click.
 - In "Axis02", create the variable "Config" of type UDT 872. These are specific axis configuration data.
 - In "Axis02", create the variable "Axis" of type UDT 860. During operation, all operating data of the axis are stored here.

DB 11

Address	Name	Type	...
		Struct	
...	Config	"VMC_ConfigSigma7EC_REF"	
...	Axis	"MC_AXIS_REF"	
...		END_STRUCT	

OB 1

Configuration of the double-axis

Open OB 1 and program the following FB calls with associated DBs:

→ FB 874 - VMC_InitSigma7W_EC, DB 874 ↪ *Chap. 13.2.3.5.3 'FB 874 - VMC_InitSigma7W_EC - Sigma-7W EtherCAT Initialization' page 401*

At *M1/M2_PdoInputs* respectively *M1/M2_PdoOutputs*, enter the address from the *SPEED7 EtherCAT Manager* for the according axis. ↪ 393

```
⇒ CALL "VMC_InitSigma7W_EC" , "DI_InitSgm7WETC01"
   Enable                               :=TRUE
   LogicalAddress                       :=0
   M1_PdoInputs                         :=0 (EtherCAT-Manager
                                           Module1: S7 Input address)

   M1_PdoOutputs                       :=0 (EtherCAT-Manager
                                           Module1: S7 Output address)

   M1_EncoderType                      :=2
   M1_EncoderResolutionBits            :=20
   M1_FactorPosition                   :=1.048576e+006
   M1_FactorVelocity                   :=1.048576e+006
   M1_FactorAcceleration               :=1.048576e+002
   M1_OffsetPosition                   :=0.000000e+000
   M1_MaxVelocityApp                   :=5.000000e+001
   M1_MaxAccelerationApp               :=1.000000e+002
   M1_MaxDecelerationApp               :=1.000000e+002
   M1_MaxVelocityDrive                 :=6.000000e+001
   M1_MaxAccelerationDrive             :=1.500000e+002
   M1_MaxDecelerationDrive             :=1.500000e+002
   M1_MaxPosition                      :=1.048500e+003
   M1_MinPosition                      :=-1.048514e+003
   M1_EnableMaxPosition                :=TRUE
   M1_EnableMinPosition                :=TRUE
   M2_PdoInputs                        :=36 (EtherCAT-Manager
                                           Module2: S7 Input address)

   M2_PdoOutputs                       :=36 (EtherCAT-Manager
                                           Module2: S7 Output address)

   M2_EncoderType                      :=2
   M2_EncoderResolutionBits            :=20
   M2_FactorPosition                   :=1.048576e+006
   M2_FactorVelocity                   :=1.048576e+006
   M2_FactorAcceleration               :=1.048576e+002
   M2_OffsetPosition                   :=0.000000e+000
   M2_MaxVelocityApp                   :=5.000000e+001
   M2_MaxAccelerationApp               :=1.000000e+002
   M2_MaxDecelerationApp               :=1.000000e+002
   M2_MaxVelocityDrive                 :=6.000000e+001
   M2_MaxAccelerationDrive             :=1.500000e+002
   M2_MaxDecelerationDrive             :=1.500000e+002
   M2_MaxPosition                      :=1.048500e+003
   M2_MinPosition                      :=-1.048514e+003
   M2_EnableMaxPosition                :=TRUE
   M2_EnableMinPosition                :=TRUE
   M1_MinUserPosition                  :=-1000.0
   M1_MaxUserPosition                  :=1000.0
   M2_MinUserPosition                  :=-1000.0
   M2_MaxUserPosition                  :=1000.0
   Valid                               :="InitS7WEC1_Valid"
   Error                               :="InitS7WEC1_Error"
```



```

ErrorID                := "InitS7WEC1_ErrorID"
M1_Config              := "Axis01".Config
M1_Axis                := "Axis01".Axis
M2_Config              := "Axis02".Config
M2_Axis                := "Axis02".Axis

```

Connecting the kernel for the respective axis

The *Kernel* processes the user commands and passes them appropriately processed on to the drive via the respective bus system.

➔ FB 872 - VMC_KernelSigma7_EC, DB 872 for axis 1

FB 872 - VMC_KernelSigma7_EC, DB 1872 for axis 2 ↪ *Chap. 13.2.2.5.2 'FB 872 - VMC_KernelSigma7_EC - Sigma-7 EtherCAT Kernel' page 360*

```

⇒ CALL "VMC_KernelSigma7_EC" , DB 872
   Init := "KernelS7WEC1_Init"
   Config := "Axis01".Config
   Axis := "Axis01".Axis

CALL "VMC_KernelSigma7_EC" , DB 1872
   Init := "KernelS7WEC2_Init"
   Config := "Axis02".Config
   Axis := "Axis02".Axis

```

Connecting the block for motion sequences

For simplicity, the connection of the FB 860 - VMC_AxisControl is to be shown here. This universal block supports simple motion commands and returns status messages. The inputs and outputs can be individually connected. Please specify the reference to the corresponding axis data at 'Axis' in the axis DB.

→ FB 860 - VMC_AxisControl, DB 860 ↪ *Chap. 13.7.2.2 'FB 860 - VMC_AxisControl - Control block axis control' page 544*

```
⇒ CALL "VMC_AxisControl" , "DI_AxisControl01"
   AxisEnable           := "AxCtrl1_AxisEnable"
   AxisReset            := "AxCtrl1_AxisReset"
   HomeExecute          := "AxCtrl1_HomeExecute"
   HomePosition         := "AxCtrl1_HomePosition"
   StopExecute          := "AxCtrl1_StopExecute"
   MvVelocityExecute    := "AxCtrl1_MvVelExecute"
   MvRelativeExecute    := "AxCtrl1_MvRelExecute"
   MvAbsoluteExecute    := "AxCtrl1_MvAbsExecute"
   PositionDistance     := "AxCtrl1_PositionDistance"
   Velocity             := "AxCtrl1_Velocity"
   Acceleration         := "AxCtrl1_Acceleration"
   Deceleration         := "AxCtrl1_Deceleration"
   JogPositive          := "AxCtrl1_JogPositive"
   JogNegative          := "AxCtrl1_JogNegative"
   JogVelocity          := "AxCtrl1_JogVelocity"
   JogAcceleration      := "AxCtrl1_JogAcceleration"
   JogDeceleration      := "AxCtrl1_JogDeceleration"
   AxisReady            := "AxCtrl1_AxisReady"
   AxisEnabled          := "AxCtrl1_AxisEnabled"
   AxisError            := "AxCtrl1_AxisError"
   AxisErrorID          := "AxCtrl1_AxisErrorID"
   DriveWarning         := "AxCtrl1_DriveWarning"
   DriveError           := "AxCtrl1_DriveError"
   DriveErrorID         := "AxCtrl1_DriveErrorID"
   IsHomed              := "AxCtrl1_IsHomed"
   ModeOfOperation      := "AxCtrl1_ModeOfOperation"
   PLCopenState         := "AxCtrl1_PLCopenState"
   ActualPosition       := "AxCtrl1_ActualPosition"
   ActualVelocity       := "AxCtrl1_ActualVelocity"
   CmdDone              := "AxCtrl1_CmdDone"
   CmdBusy              := "AxCtrl1_CmdBusy"
   CmdAborted           := "AxCtrl1_CmdAborted"
   CmdError             := "AxCtrl1_CmdError"
   CmdErrorID           := "AxCtrl1_CmdErrorID"
   DirectionPositive    := "AxCtrl1_DirectionPos"
   DirectionNegative    := "AxCtrl1_DirectionNeg"
   SWLimitMinActive     := "AxCtrl1_SWLimitMinActive"
   SWLimitMaxActive     := "AxCtrl1_SWLimitMaxActive"
   HWLimitMinActive     := "AxCtrl1_HWLimitMinActive"
   HWLimitMaxActive     := "AxCtrl1_HWLimitMaxActive"
   Axis                 := "Axis..."_Axis
```

At Axis, enter "Axis01" for axis 1 and "Axis02" for axis 2.



For complex motion tasks, you can use the PLCopen blocks. Here you must also specify the reference to the corresponding axis data at Axis in the axis DB.

Your project now includes the following blocks:

- OB 1 - Main
- OB 57 - DP Manufacturer Alarm
- OB 82 - I/O_FLT1
- OB 86 - Rack_FLT

- FB 860 - VMC_AxisControl with instance DB
- FB 872 - VMC_KernelSigma7_EC with instance DB
- FB 874 - VMC_InitSigma7W_EC with instance DB
- UDT 860 - MC_Axis_REF
- UDT 872 - VMC_ConfigSigma7EC_REF

Sequence of operations

1. ➤ Choose the Siemens SIMATIC Manager and transfer your project into the CPU.

The transfer can only be done by the Siemens SIMATIC Manager - not hardware configurator!



Since slave and module parameters are transmitted by means of SDO respectively SDO Init command, the configuration remains active, until a power cycle is performed or new parameters for the same SDO objects are transferred.

With an overall reset the slave and module parameters are not reset!

⇒ You can take your application into operation now.



CAUTION!

Please always observe the safety instructions for your drive, especially during commissioning!

2. ➤ Before the double-axis drive can be controlled, it must be initialized. To do this, call the *Init* block FB 874 - VMC_InitSigma7W_EC with *Enable* = TRUE.

⇒ The output *Valid* returns TRUE. In the event of a fault, you can determine the error by evaluating the *ErrorID*.

You have to call the *Init* block again if you load a new axis DB or you have changed parameters on the *Init* block.



Do not continue until the Init block does not report any errors!

3. ➤ Ensure that the *Kernel* block FB 872 - VMC_KernelSigma7_EC is called cyclically for each axis. In this way, control signals are transmitted to the drive and status messages are reported.
4. ➤ Program your application with the FB 860 - VMC_AxisControl or with the PLCopen blocks for each axis.

Controlling the drive via HMI

There is the possibility to control your drive via HMI. For this, a predefined symbol library is available for Movicon to access the VMC_AxisControl function block. ↪ *Chap. 13.8 'Controlling the drive via HMI' page 613*

13.2.3.4.4 Copy project

Proceeding

In the example, the station 'Source' is copied and saved as 'Target'.

1. ➤ Open the hardware configuration of the 'Source' CPU and start the *SPEED7 EtherCAT Manager*.
2. ➤ In the *SPEED7 EtherCAT Manager*, via 'File → Save as' save the configuration in your working directory.
3. ➤ Close the *SPEED7 EtherCAT Manager* and the hardware configurator.
4. ➤ Copy the station 'Source' with Ctrl + C and paste it as 'Target' into your project with Ctrl + V.
5. ➤ Select the 'Blocks' directory of the 'Target' CPU and delete the 'System data'.
6. ➤ Open the hardware configuration of the 'Target' CPU. Adapt the IP address data or re-network the CPU or the CP again.



Before calling the SPEED7 EtherCAT Manager you have always to save your project with 'Station → Save and compile'.

7. ➤ Save your project with 'Station → Save and compile'.
8. ➤ Open the *SPEED7 EtherCAT Manager*.
9. ➤ Use 'File → Open' to load the configuration from your working directory.
10. ➤ Close the *SPEED7 EtherCAT Manager*.
11. ➤ Save and compile your configuration.

13.2.3.5 Drive specific blocks



The PLCopen blocks for axis control can be found here: [🔗 Chap. 13.7 'Blocks for axis control' page 542](#)

13.2.3.5.1 UDT 872 - VMC_ConfigSigma7EC_REF - Sigma-7 EtherCAT Data structure axis configuration

This is a user-defined data structure that contains information about the configuration data. The UDT is specially adapted to the use of a *Sigma-7* drive, which is connected via EtherCAT.

13.2.3.5.2 FB 872 - VMC_KernelSigma7_EC - Sigma-7 EtherCAT Kernel

Description

This block converts the drive commands for a *Sigma-7* axis via EtherCAT and communicates with the drive. For each *Sigma-7* axis, an instance of this FB is to be cyclically called.



Please note that this module calls the SFB 238 internally.

In the SPEED7 Studio, this module is automatically inserted into your project.

In Siemens SIMATIC Manager, you have to copy the SFB 238 from the Motion Control Library into your project.

Parameter	Declaration	Data type	Description
Init	INPUT	BOOL	The block is internally reset with an edge 0-1. Existing motion commands are aborted and the block is initialized.
Config	IN_OUT	UDT872	Data structure for transferring axis-dependent configuration data to the <i>AxisKernel</i> .
Axis	IN_OUT	MC_AXIS_REF	Data structure for transferring axis-dependent information to the <i>AxisKernel</i> and PLCopen blocks.

13.2.3.5.3 FB 874 - VMC_InitSigma7W_EC - Sigma-7W EtherCAT Initialization

Description

This block is used to configure the double-axis of a *Sigma-7W* drive. The block is specially adapted to the use of a *Sigma-7W* drive, which is connected via EtherCAT.

Parameter	Declaration	Data type	Description
M1_Config	IN_OUT	UDT872	Data structure for transferring axis-dependent configuration data to the <i>AxisKernel</i> for axis 1.
M1_Axis	IN_OUT	MC_AXIS_REF	Data structure for transferring axis-dependent information to the <i>AxisKernel</i> and PLCopen blocks for axis 1.
M2_Config	IN_OUT	UDT872	Data structure for transferring axis-dependent configuration data to the <i>AxisKernel</i> for axis 2.

Parameter	Declaration	Data type	Description
M2_Axis	IN_OUT	MC_AXIS_REF	Data structure for transferring axis-dependent information to the <i>AxisKernel</i> and PLCopen blocks for axis 2.
Enable	INPUT	BOOL	Release of initialization
LogicalAddress	INPUT	INT	Start address of the PDO input data
M1_PdoInputs	INPUT	INT	Start address of the input PDOs for axis 1
M1_PdoOutputs	INPUT	INT	Start address of the output PDOs for axis 1
M1_EncoderType	INPUT	INT	Encoder type of axis 1 <ul style="list-style-type: none"> ■ 1: Absolute encoder ■ 2: Incremental encoder
M1_EncoderResolutionBits	INPUT	INT	Number of bits corresponding to one encoder revolution of axis 1. Default: 20
M1_FactorPosition	INPUT	REAL	Factor for converting the position of user units [u] into drive units [increments] and back of axis 1. It's valid: $p_{[\text{increments}]} = p_{[u]} \times \text{FactorPosition}$ Please consider the factor which can be specified on the drive via the objects 0x2701: 1 and 0x2701: 2. This should be 1.
M1_FactorVelocity	INPUT	REAL	Factor for converting the speed of user units [u/s] into drive units [increments/s] and back of axis 1. It's valid: $v_{[\text{increments/s}]} = v_{[u/s]} \times \text{FactorVelocity}$ Please also take into account the factor which you can specify on the drive via objects 0x2702: 1 and 0x2702: 2. This should be 1.
M1_FactorAcceleration	INPUT	REAL	Factor to convert the acceleration of user units [u/s ²] in drive units [10 ⁻⁴ x increments/s ²] and back of axis 1. It's valid: $10^{-4} \times a_{[\text{increments/s}^2]} = a_{[u/s^2]} \times \text{FactorAcceleration}$ Please also take into account the factor which you can specify on the drive via objects 0x2703: 1 and 0x2703: 2. This should be 1.
M1_OffsetPosition	INPUT	REAL	Offset for the zero position of axis 1 [u].
M1_MaxVelocityApp	INPUT	REAL	Maximum application speed of axis 1 [u/s]. The command inputs are checked to the maximum value before execution.
M1_MaxAccelerationApp	INPUT	REAL	Maximum acceleration of application of axis 1 [u/s ²]. The command inputs are checked to the maximum value before execution.
M1_MaxDecelerationApp	INPUT	REAL	Maximum acceleration of application of axis 1 [u/s ²]. The command inputs are checked to the maximum value before execution.
M1_MaxPosition	INPUT	REAL	Maximum position for monitoring the software limits of axis 1 [u].
M1_MinPosition	INPUT	REAL	Minimum position for monitoring the software limits of axis 1 [u].

Parameter	Declaration	Data type	Description
M1_EnableMaxPosition	INPUT	BOOL	Monitoring maximum position of axis 1 <ul style="list-style-type: none"> TRUE: Activates the monitoring of the maximum position.
M1_EnableMinPosition	INPUT	BOOL	Monitoring minimum position of axis 1 <ul style="list-style-type: none"> TRUE: Activation of the monitoring of the minimum position.
M2_PdoInputs	INPUT	INT	Start address of the input PDOs for axis 2
M2_PdoOutputs	INPUT	INT	Start address of the output PDOs for axis 2
M2_EncoderType	INPUT	INT	Encoder type of axis 2 <ul style="list-style-type: none"> 1: Absolute encoder 2: Incremental encoder
M2_EncoderResolutionBits	INPUT	INT	Number of bits corresponding to one encoder revolution of axis 2. Default: 20
M2_FactorPosition	INPUT	REAL	Factor for converting the position of user units [u] into drive units [increments] and back of axis 2. It's valid: $p_{[increments]} = p_{[u]} \times FactorPosition$ Please consider the factor which can be specified on the drive via the objects 0x2701: 1 and 0x2701: 2. This should be 1.
M2_FactorVelocity	INPUT	REAL	Factor for converting the speed of user units [u/s] into drive units [increments/s] and back of axis 2. It's valid: $v_{[increments/s]} = v_{[u/s]} \times FactorVelocity$ Please also take into account the factor which you can specify on the drive via objects 0x2702: 1 and 0x2702: 2. This should be 1.
M2_FactorAcceleration	INPUT	REAL	Factor to convert the acceleration of user units [u/s^2] in drive units [$10^{-4} \times increments/s^2$] and back of axis 2. It's valid: $10^{-4} \times a_{[increments/s^2]} = a_{[u/s^2]} \times FactorAcceleration$ Please also take into account the factor which you can specify on the drive via objects 0x2703: 1 and 0x2703: 2. This should be 1.
M2_OffsetPosition	INPUT	REAL	Offset for the zero position of axis 2 [u].
M2_MaxVelocityApp	INPUT	REAL	Maximum application speed of axis 2 [u/s]. The command inputs are checked to the maximum value before execution.
M2_MaxAccelerationApp	INPUT	REAL	Maximum acceleration of application of axis 2 [u/s^2]. The command inputs are checked to the maximum value before execution.
M2_MaxDecelerationApp	INPUT	REAL	Maximum acceleration of application of axis 2 [u/s^2]. The command inputs are checked to the maximum value before execution.
M2_MaxPosition	INPUT	REAL	Maximum position for monitoring the software limits of axis 2 [u].

Usage Sigma-5/7 EtherCAT > Usage Sigma-7W EtherCAT

Parameter	Declaration	Data type	Description
M2_MinPosition	INPUT	REAL	Minimum position for monitoring the software limits of axis 2 [u].
M2_EnableMaxPosition	INPUT	BOOL	Monitoring maximum position of axis 2 <ul style="list-style-type: none"> ■ TRUE: Activates the monitoring of the maximum position.
M2_EnableMinPosition	INPUT	BOOL	Monitoring minimum position of axis 2 <ul style="list-style-type: none"> ■ TRUE: Activation of the monitoring of the minimum position.
M1_MinUserPosition	OUTPUT	REAL	Minimum user position for axis 1 based on the minimum encoder value of 0x80000000 and the <i>FactorPosition</i> [u].
M1_MaxUserPosition	OUTPUT	REAL	Maximum user position for axis 1 based on the maximum encoder value of 0x7FFFFFFF and the <i>FactorPosition</i> [u].
M2_MinUserPosition	OUTPUT	REAL	Minimum user position for axis 2 based on the minimum encoder value of 0x80000000 and the <i>FactorPosition</i> [u].
M2_MaxUserPosition	OUTPUT	REAL	Maximum user position for axis 2 based on the maximum encoder value of 0x7FFFFFFF and the <i>FactorPosition</i> [u].
Valid	OUTPUT	BOOL	Initialization <ul style="list-style-type: none"> ■ TRUE: Initialization is valid.
Error	OUTPUT	BOOL	<ul style="list-style-type: none"> ■ Error <ul style="list-style-type: none"> – TRUE: An error has occurred. Additional error information can be found in the parameter <i>ErrorID</i>. The axis is disabled.
ErrorID	OUTPUT	WORD	Additional error information 🔗 Chap. 13.10 'ErrorID - Additional error information' page 637

13.3 Usage *Sigma-5/7* Pulse Train

13.3.1 Overview

Precondition

- SPEED7 Studio from V1.7
or
- Siemens SIMATIC Manager from V 5.5, SP2 & *Simple Motion Control Library*
or
- Siemens TIA Portal V 14 & *Simple Motion Control Library*
- System MICRO or System SLIO CPU with Pulse Train output, such as CPU M13-CCF0000 or CPU 013-CCF0R00.
- *Sigma-5-* respectively *Sigma-7* drive with Pulse Train option card

Steps of configuration

1. ➤ Setting parameters on the drive
 - The setting of the parameters happens by means of the software tool *Sigma Win+*.
2. ➤ Hardware configuration in the *VIPA SPEED7 Studio*, Siemens SIMATIC Manager or Siemens TIA Portal.
 - Configuring the CPU.
3. ➤ Programming in the *VIPA SPEED7 Studio*, Siemens SIMATIC Manager or Siemens TIA Portal.
 - *VMC_AxisControl_PT* block for configuration and communication with the axis, which is connected via Pulse Train.

13.3.2 Set the parameters on the drive

Parameter digits

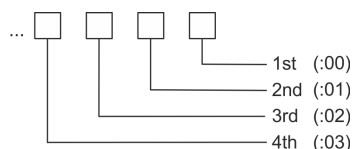

CAUTION!

Before the commissioning, you have to adapt your drive to your application with the *Sigma Win+* software tool! More may be found in the manual of your drive.

The following table shows all parameters which do not correspond to the default values. The following parameters must be set via *Sigma Win+* to match the *Simple Motion Control Library*:

Sigma-5/7

Servopack Parameter	Address:digit	Name	Value
Pn000	(2000h:01)	Basic Function Selection Switch 0	1: Position control (pulse train reference)
Pn002	(2002h:02)	Application Function Select Switch 2	1: Uses absolute encoder as incremental encoder
Pn200	(2200h:03)	Position Control Reference From Selection Switch	1: Uses reference input filter for open collector signal
Pn20E	(220Eh)	Electronic Gear Ratio (Numerator)	1024
Pn216	(2216h)	Position Reference Acceleration / Deceleration Time Constant	0
Pn217	(2217h)	Average Movement Time of Position Reference	0

Usage Sigma-5/7 Pulse Train > Wiring

Servopack Parameter	Address:digit	Name	Value
Pn50A	(250Ah:02)	/P-CON Signal Mapping	8: Sets signal off
Pn50A	(250Ah:03)	P-OT Signal Mapping	8: Forward run allowed
Pn50B	(250Bh:00)	N-OT Signal Mapping	8: Reverse run allowed
Pn50B	(250Bh:02)	/P-CL Signal Mapping	8: Sets signal off
Pn50B	(250Bh:03)	/N-CL Signal Mapping	8: Sets signal off

13.3.3 Wiring

Sample application

The following figure shows the connection of a Sigma-5 servo drive via Pulse Train to a system MICRO CPU M13C. In this example the pulse train channel 0 (X2 - pin 8) is connected. Please use X2 pin 7 to connect to channel 1.

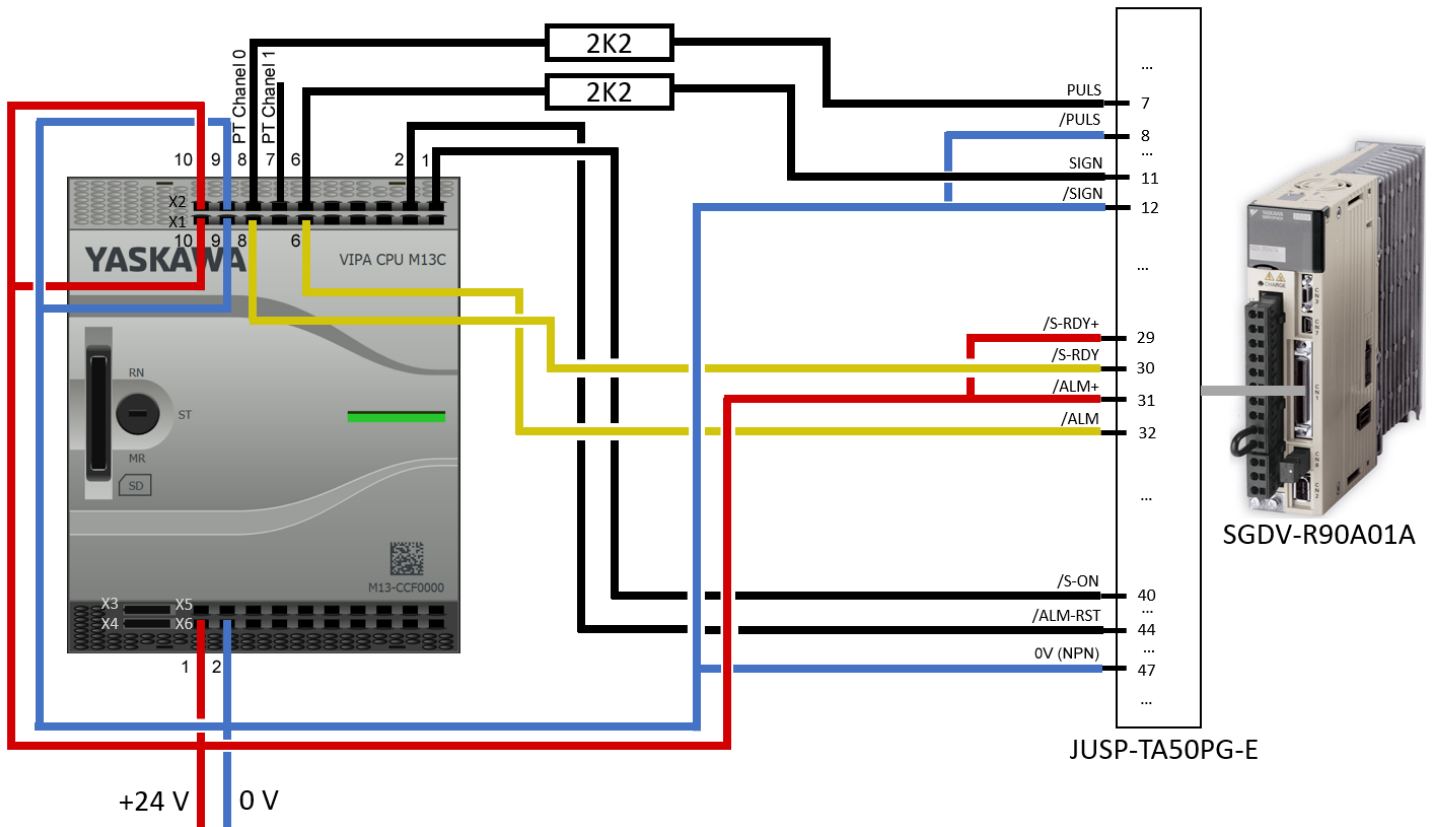

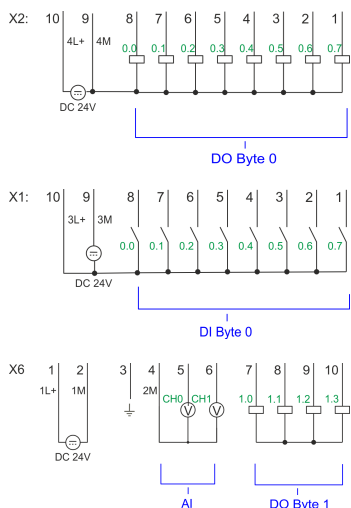

X2	Function	Type	LED green red	Description
1	DO 0.7	O	green	Digital output DO 7
2	DO 0.6	O	green	Digital output DO 6
6	DO 0.2	O	green	Digital output DO 2
7	DO 0.1	O	green	Pulse Train Channel 1
8	DO 0.0	O	green	Pulse Train Channel 0
9	0 V	I	red	4M: GND for Pulse Train LED is on when there is an error, overload or short circuit at the outputs
10	DC 24V	I	green	4L+: DC 24V power supply for Pulse Train

X1	Function	Type	LED green	Description
6	DI 0.2	I	green	Digital input DI 2
8	DI 0.0	I	green	Digital input DI 0
9	0 V	I		3M: GND power section supply for on-board DI
10	DC 24V	I	green	3L+: DC 24V power section supply for on-board DI

X6	Function	Type	LED green	Description
1	Sys DC 24V	I	green	1L+: DC 24V for electronic section supply
2	Sys 0V	I		1M: GND for electronic section supply

13.3.4 Usage in VIPA *SPEED7 Studio*

13.3.4.1 Hardware configuration

Add CPU in the project

Please use the *SPEED7 Studio V1.7* and up for the configuration.

If you are using a channel other than channel 0, you must adapt it in the hardware configuration and in your user program.

1. Start the *SPEED7 Studio*.

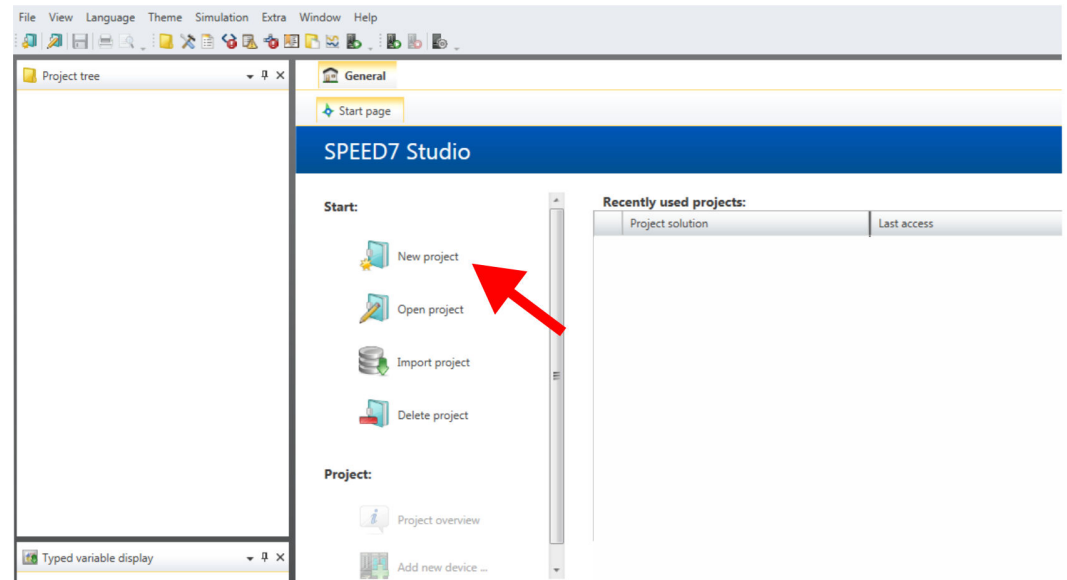

2. Create a new project at the start page with 'New project' and assign a 'Project name'.

⇒ A new project is created and the view 'Devices and networking' is shown.

3. Click in the *Project tree* at 'Add new device ...'.

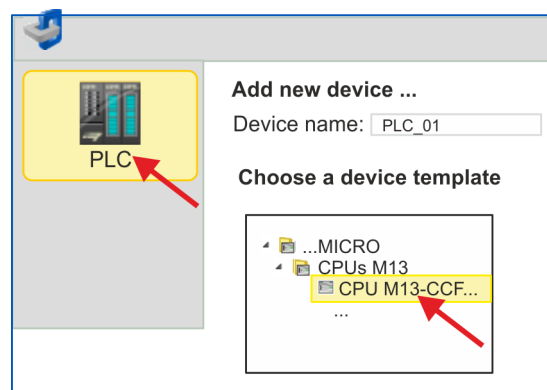
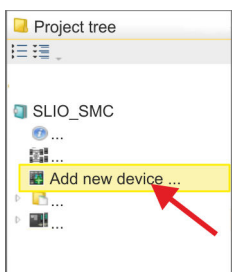

⇒ A dialog for device selection opens.

4. Select from the 'Device templates' your CPU with Pulse Train functionality like the System MICRO CPU M13-CCF0000 and click at [OK].

⇒ The CPU is inserted in 'Devices and networking' and the 'Device configuration' is opened.

Configuration of Ethernet PG/OP channel

1. Click in the *Project tree* at '*Devices and networking*'.
⇒ You will get a graphical object view of your CPU.

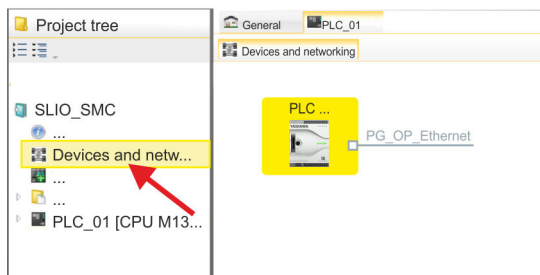

2. Click at the network '*PG_OP_Ethernet*'.
3. Select '*Context menu* → *Interface properties*'.
⇒ A dialog window opens. Here you can enter the IP address data for your Ethernet PG/OP channel. You get valid IP address parameters from your system administrator.
4. Confirm with [OK].
⇒ The IP address data are stored in your project listed in '*Devices and networking*' at '*Local components*'.
After transferring your project your CPU can be accessed via Ethernet PG/OP channel with the set IP address data.

Switch I/O periphery to Pulse Train

For parametrization of the I/O periphery and the *technological functions* the corresponding sub modules of the CPU are to be used. For pulse train output, the sub module count must be switched to '*Pulse-width modulation*'.

1. Click in the *Project tree* at '*PLC... > Device configuration*'.
2. Click in the '*Device configuration*' at '*-X27 Count*' and select '*Context menu* → *Components properties*'.
⇒ The properties dialog is opened.
3. For example, select '*channel 0*' and select the function '*Pulse-width modulation*' as '*Operating mode*'.

4. The operating parameters required for Pulse Train are internally adapted to the corresponding values. Leave all values unchanged.

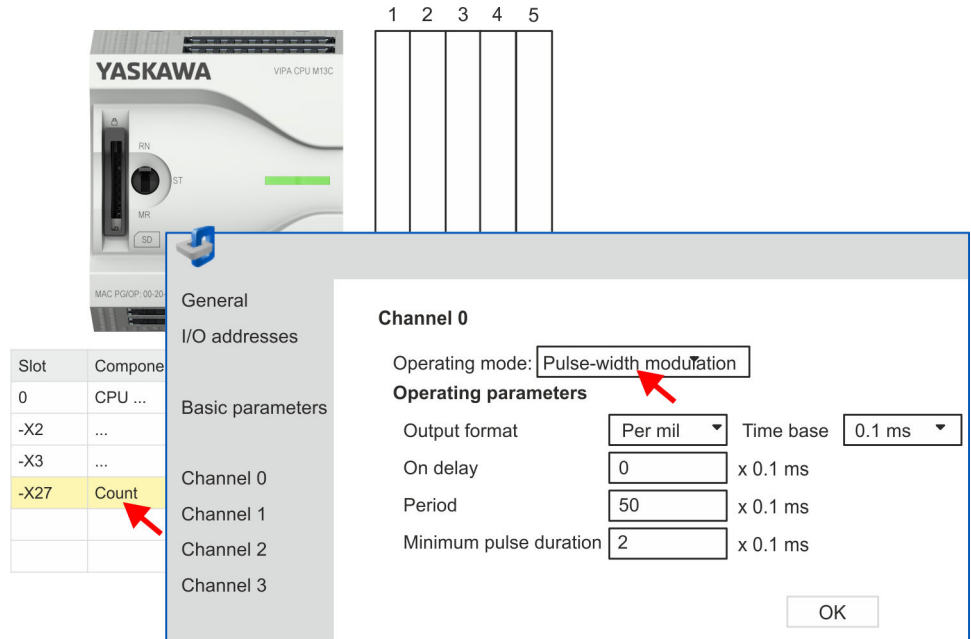

5. Close the dialog with [OK].
6. Select 'Project → Compile all'.

13.3.4.2 User program Copy block to project

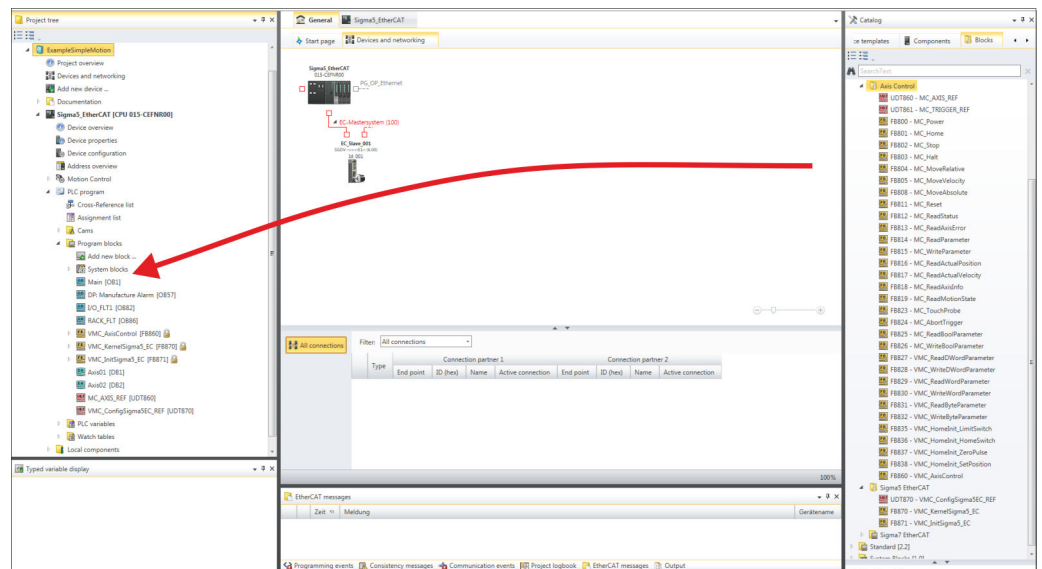

- In the 'Catalog', open the 'Simple Motion Control' library at 'Blocks' and drag and drop the following blocks into 'Program blocks' of the Project tree:

- Sigma5+7 Pulse Train
 - FB 875 - VMC_AxisControl_PT ↪ Chap. 13.3.7.1 'FB 875 - VMC_AxisControl_PT - Axis control via Pulse Train' page 423

OB 1

Configuration of the axis

If you are using a channel other than channel 0, you must adapt it in the hardware configuration and in your user program.

1. Open in the *Project tree* within the CPU at '*PLC program*', '*Programming blocks*' the OB 1 and program the Call FB 875, DB 875.
 - ⇒ The dialog '*Add instance data block*' opens.
2. Set the number for the instance data block, if not already done, and close the dialog with [OK].
 - ⇒ The block call is created and the parameters are listed
3. Assign the following parameters for the sample project. In particular, consider the two conversion factors *FactorPosition* and *FactorVelocity*:

```

⇒ CALL FB    "VMC_AxisControl_PT" , "DI_AxisControl_PT"
           S_ChannelNumberPWM      := 0
           S_Ready                 := E 136.0
           S_Alarm                 := E 136.2
           FactorPosition          := 1024.0
           FactorVelocity          := 976.5625
           AxisEnable              := M 100.1
           AxisReset               := M 100.2
           StopExecute             := M 100.3
           MvVelocityExecute       := M 100.4
           MvRelativeExecute       := M 100.5
           JogPositive             := M 100.6
           JogNegative             := M 100.7
           PositionDistance        := MD 102
           Velocity                := MD 106
           S_On                    := A 136.7
           S_Direction             := A 136.2
           S_AlarmReset           := A 136.6
           MinUserDistance        := MD 110
           MaxUserDistance        := MD 114
           MinUserVelocity        := MD 118
           MaxUserVelocity        := MD 122
           AxisReady              := M 101.3
           AxisEnabled            := M 101.4
           AxisError              := M 101.5
           AxisErrorID            := MW 126
           DriveError             := M 101.6
           CmdActive              := MB 128
           CmdDone                := M 130.0
           CmdBusy                := M 130.1
           CmdAborted             := M 130.2
           CmdError               := M 130.3
           CmdErrorID            := MW 132

```

The addresses of *S_Ready* and *S_Alarm* are derived from the addresses of the inputs which are connected to the drive's digital outputs. These can be determined via the sub module '*-X25 DI/DIO*' of the CPU.



The addresses of *S_On*, *S_Direction* and *S_AlarmReset* are obtained from the addresses of the outputs which are connected to the digital inputs of the drive. These can be determined via the sub module '*-X25 DI/DIO*' of the CPU.

Sequence of operations

1.  Select '*Project* → *Compile all*' and transfer the project into your CPU. You can find more information on the transfer of your project in the online help of the *SPEED7 Studio*.
⇒ You can take your application into operation now.

**CAUTION!**

Please always observe the safety instructions for your drive, especially during commissioning!

2.  Bring your CPU into RUN and turn on your drive.
⇒ The FB 875 - VMC_AxisControl_PT is executed cyclically.
3.  As soon as *AxisReady* = TRUE, you can use *AxisEnable* to enable the drive.
4.  You now have the possibility to control your drive via its parameters and to check its status. ↪ *Chap. 13.3.7.1 'FB 875 - VMC_AxisControl_PT - Axis control via Pulse Train' page 423*

Controlling the drive via HMI

There is the possibility to control your drive via an HMI. For this purpose, a predefined symbol library is available for Movicon to access the VMC_AxisControl_PT function module. ↪ *Chap. 13.8 'Controlling the drive via HMI' page 613*

13.3.5 Usage in Siemens SIMATIC Manager**13.3.5.1 Precondition****Overview**

- Please use for configuration the Siemens SIMATIC Manager V 5.5 SP2 and up.
- The configuration of the VIPA CPU with Pulse Train functionality happens in the Siemens SIMATIC Manager by means of a virtual PROFINET IO device.
- The PROFINET IO Device is to be installed in the hardware catalog by means of a GSDML.

Installing the VIPA IO device

The installation of the PROFINET VIPA IO device happens in the hardware catalog with the following approach:

1.  Go to the service area of www.vipa.com.
2.  Download the configuration file for your CPU from the download area via '*Config files* → *PROFINET*'.
3.  Extract the file into your working directory.
4.  Start the Siemens hardware configurator.
5.  Close all the projects.
6.  Select '*Options* → *Install new GSD file*'.
7.  Navigate to your working directory and install the according GSDML file.
⇒ After the installation according PROFINET IO device can be found at '*PROFINET IO* → *Additional field devices* → *I/O* → *VIPA ...*'.

13.3.5.2 Hardware configuration

Add CPU in the project

Slot	Module
1	
2	CPU 314C-2PN/DP
X1	MPI/DP
X2	PN-IO
X2...	Port 1
X2...	Port 2
...	...
3	

To be compatible with the Siemens SIMATIC Manager the following steps should be executed:

1. Start the Siemens hardware configurator with a new project.
2. Insert a profile rail from the hardware catalog.
3. Place at 'Slot'-Number 2 the CPU 314C-2 PN/DP (314-6EH04-0AB0 V3.3).
4. Click at the sub module 'PN-IO' of the CPU.
5. Select 'Context menu → Insert PROFINET IO System'.

Slot	Module
1	
2	CPU ...
X...	PN-IO
3	



6. Create with [New] a new sub net and assign valid address data.
7. Click at the sub module 'PN-IO' of the CPU and open with 'Context menu → Properties' the properties dialog.
8. Enter at 'General' a 'Device name'. The device name must be unique at the Ethernet subnet.

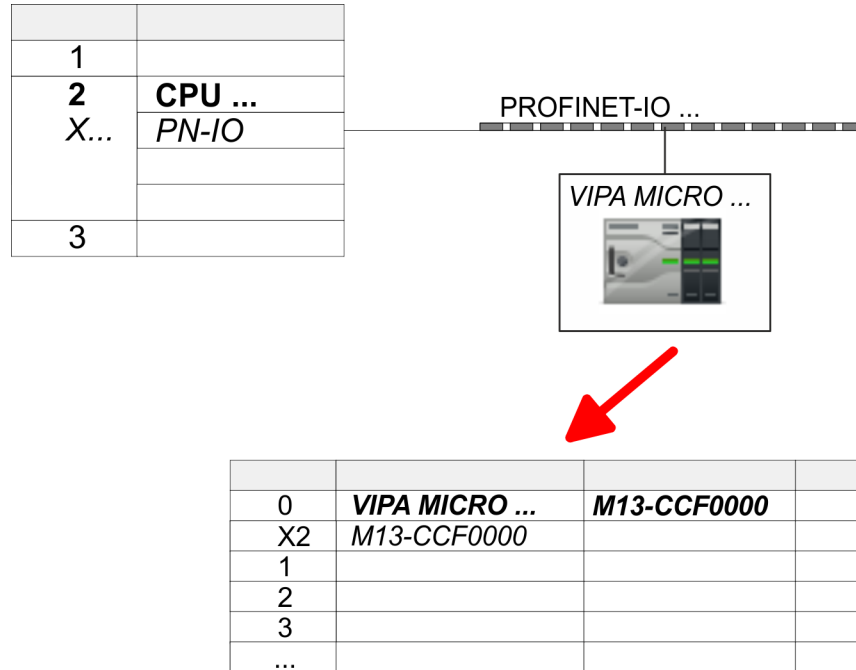

9. ➤ Navigate in the hardware catalog to the directory 'PROFINET IO ➔ Additional field devices ➔ I/O ➔ VIPA ...' and connect e.g. for the System MICRO the IO device 'M13-CCF0000' to your PROFINET system.
 - ⇒ In the *Device overview* of the PROFINET IO device 'VIPA MICRO PLC' the CPU is already placed at slot 0.

Configuration of Ethernet PG/OP channel

Slot	Module
1	
2	CPU ...
X...	<i>PN-IO</i>
3	
4	343-1EX30
5	
...	

1. ➤ Place for the Ethernet PG/OP channel at slot 4 the Siemens CP 343-1 (SIMATIC 300 \ CP 300 \ Industrial Ethernet \ CP 343-1 \ 6GK7 343-1EX30 0XE0 V3.0).
2. ➤ Open the properties dialog by clicking on the CP 343-1EX30 and enter for the CP at 'Properties' the IP address data. You get valid IP address parameters from your system administrator.
3. ➤ Assign the CP to a 'Subnet'. The IP address data are not accepted without assignment!

Switch I/O periphery to Pulse Train

For parametrization of the input/output periphery and the *technological functions* the corresponding sub modules of the Siemens CPU 314C-2 PN/DP (314-6EH04-0AB0 V3.3) is to be used. For pulse train output, the sub module count must be switched to 'Pulse-width modulation'. If you are using a channel other than channel 0, you must adapt it in the hardware configuration and in your user program.

1. ➤ Double-click the counter sub module of the CPU 314C-2 PN/DP.
 - ⇒ The dialog 'Properties' is opened.
2. ➤ For example, select 'channel 0' and select the function 'Pulse-width modulation' as 'Operating mode'.

3. Leave all values unchanged.

1	
2	CPU 314C-2 PN/DP
X1	MPI/DP
X2	PN-IO
X2 P1 R	Port 1
X2 P2 R	Port 2
2.5	DI24/DO16
2.6	AI5/AO2
2.7	Count
2.8	Position
3	

PROFINET-IO ...

VIPA MICRO...

Properties - Count

Channel: Operating mode:

4. Close the dialog with [OK].

5. Select 'Station → Save and compile'.

6. Close the hardware configurator.

13.3.5.3 User program

Include library

1. Go to the service area of www.vipa.com.
2. Download the *Simple Motion Control* library from the download area at 'VIPA Lib'.
3. Open the dialog window for ZIP file selection via 'File → Retrieve'.
4. Select the according ZIP file and click at [Open].
5. Specify a target directory in which the blocks are to be stored and start the unzip process with [OK].

Copy blocks into project

- Open the library after unzipping and drag and drop the following blocks into 'Blocks' of your project:
 - *Sigma5+7 Pulse Train*
 - FB 875 - VMC_AxisControl_PT ↗ *Chap. 13.3.7.1 'FB 875 - VMC_AxisControl_PT - Axis control via Pulse Train' page 423*

OB 1

Configuration of the axis

1. Open the OB 1 and program the Call FB 875, DB 875.
 - ⇒ The block call is created and the parameters are listed.

2. ➔ Assign the following parameters for the sample project. In particular, consider the two conversion factors *FactorPosition* and *FactorVelocity*:

```
⇒ CALL FB    "VMC_AxisControl_PT" , "DI_AxisControl_PT"
      S_ChannelNumberPWM      := 0
      S_Ready                 := E 136.0
      S_Alarm                 := E 136.2
      FactorPosition          := 1024.0
      FactorVelocity          := 976.5625
      AxisEnable              := M 100.1
      AxisReset               := M 100.2
      StopExecute             := M 100.3
      MvVelocityExecute       := M 100.4
      MvRelativeExecute       := M 100.5
      JogPositive             := M 100.6
      JogNegative             := M 100.7
      PositionDistance        := MD 102
      Velocity                := MD 106
      S_On                    := A 136.7
      S_Direction             := A 136.2
      S_AlarmReset            := A 136.6
      MinUserDistance         := MD 110
      MaxUserDistance         := MD 114
      MinUserVelocity         := MD 118
      MaxUserVelocity         := MD 122
      AxisReady               := M 101.3
      AxisEnabled              := M 101.4
      AxisError                := M 101.5
      AxisErrorID              := MW 126
      DriveError               := M 101.6
      CmdActive                := MB 128
      CmdDone                  := M 130.0
      CmdBusy                  := M 130.1
      CmdAborted               := M 130.2
      CmdError                 := M 130.3
      CmdErrorID               := MW 132
```

The addresses of *S_Ready* and *S_Alarm* are derived from the addresses of the inputs which are connected to the drive's digital outputs. These can be determined via the sub module 'DI24/DO16' of the CPU.

The addresses of *S_On*, *S_Direction* and *S_AlarmReset* are obtained from the addresses of the outputs which are connected to the digital inputs of the drive. These can be determined via the sub module 'DI24/DO16' of the CPU.

Sequence of operations

1. ➔ Choose the Siemens SIMATIC Manager and transfer your project into the CPU.
⇒ You can take your application into operation now.



CAUTION!

Please always observe the safety instructions for your drive, especially during commissioning!

2. ➔ Bring your CPU into RUN and turn on your drive.
⇒ The FB 875 - VMC_AxisControl_PT is executed cyclically.
3. ➔ As soon as *AxisReady* = TRUE, you can use *AxisEnable* to enable the drive.
4. ➔ You now have the possibility to control your drive via its parameters and to check its status. ↪ *Chap. 13.3.7.1 'FB 875 - VMC_AxisControl_PT - Axis control via Pulse Train' page 423*

Controlling the drive via HMI

There is the possibility to control your drive via an HMI. For this purpose, a predefined symbol library is available for Movicon to access the VMC_AxisControl_PT function module. ↪ *Chap. 13.8 'Controlling the drive via HMI' page 613*

13.3.6 Usage in Siemens TIA Portal

13.3.6.1 Precondition

Overview

- Please use the Siemens TIA Portal V 14 and up for the configuration.
- The configuration of the VIPA CPU with Pulse Train functionality happens in the Siemens TIA Portal by means of a virtual PROFINET IO device.
- The PROFINET IO Device is to be installed in the hardware catalog by means of a GSDML.

Installing the VIPA IO device

The installation of the PROFINET VIPA IO device happens in the hardware catalog with the following approach:

1. ➤ Go to the service area of www.vipa.com.
2. ➤ Download the according file for your system - here System MICRO from the download area via '*Config files* ➔ *PROFINET*'.
3. ➤ Extract the file into your working directory.
4. ➤ Start the Siemens TIA Portal.
5. ➤ Close all the projects.
6. ➤ Switch to the *Project view*.
7. ➤ Select '*Options* ➔ *Install general station description file (GSD)*'.
8. ➤ Navigate to your working directory and install the according GSDML file.

⇒ After the installation the hardware catalog is refreshed and the Siemens TIA Portal is closed.

After restarting the Siemens TIA Portal the according PROFINET IO device can be found at *Other field devices* > *PROFINET* > *IO* > *VIPA GmbH* > *VIPA MICRO PLC*.



Thus, the VIPA components can be displayed, you have to deactivate the "Filter" of the hardware catalog.

13.3.6.2 Hardware configuration

Add CPU in the project

To be compatible with the Siemens SIMATIC TIA Portal the following steps should be executed:

1. ➤ Start the Siemens TIA Portal with a new project.
2. ➤ Switch to the *Project view*.
3. ➤ Click in the *Project tree* at '*Add new device*'.

4. Select the following CPU in the input dialog:
SIMATIC S7-300 > CPU 314C-2 PN/DP (314-6EH04-0AB0 V3.3)
⇒ The CPU is inserted with a profile rail.

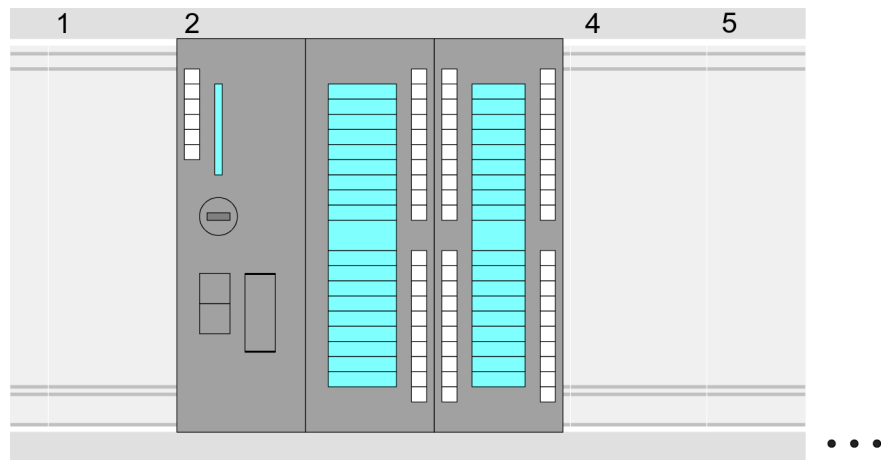

Device overview:

Module	...	Slot	...	Type	...
PLC...		2		CPU 314C-2PN/DP	
MPI interface...		2 X1		MPI/DP interface	
PROFINET inter- face...		2 X2		PROFINET interface	
DI24/DO16...		2 5		DI24/DO16	
AI5/AO2...		2 6		AI5/AO2	
Count...		2 7		Count	
...					

Connection CPU as PROFINET IO device

1. Switch in the *Project area* to 'Network view'.
2. After installing the GSDML the IO device for the SLIO CPU may be found in the hardware catalog at *Other field devices > PROFINET > IO > VIPA GmbH > VIPA MICRO PLC*. Connect the slave system to the CPU by dragging&dropping it from the hardware catalog to the *Network view* and connecting it via PROFINET to the CPU.
3. Click in the *Network view* at the PROFINET part of the Siemens CPU and enter at valid IP address data in 'Properties' at 'Ethernet address' in the area 'IP protocol'.
4. Enter at 'PROFINET' a 'PROFINET device name'. The device name must be unique at the Ethernet subnet.

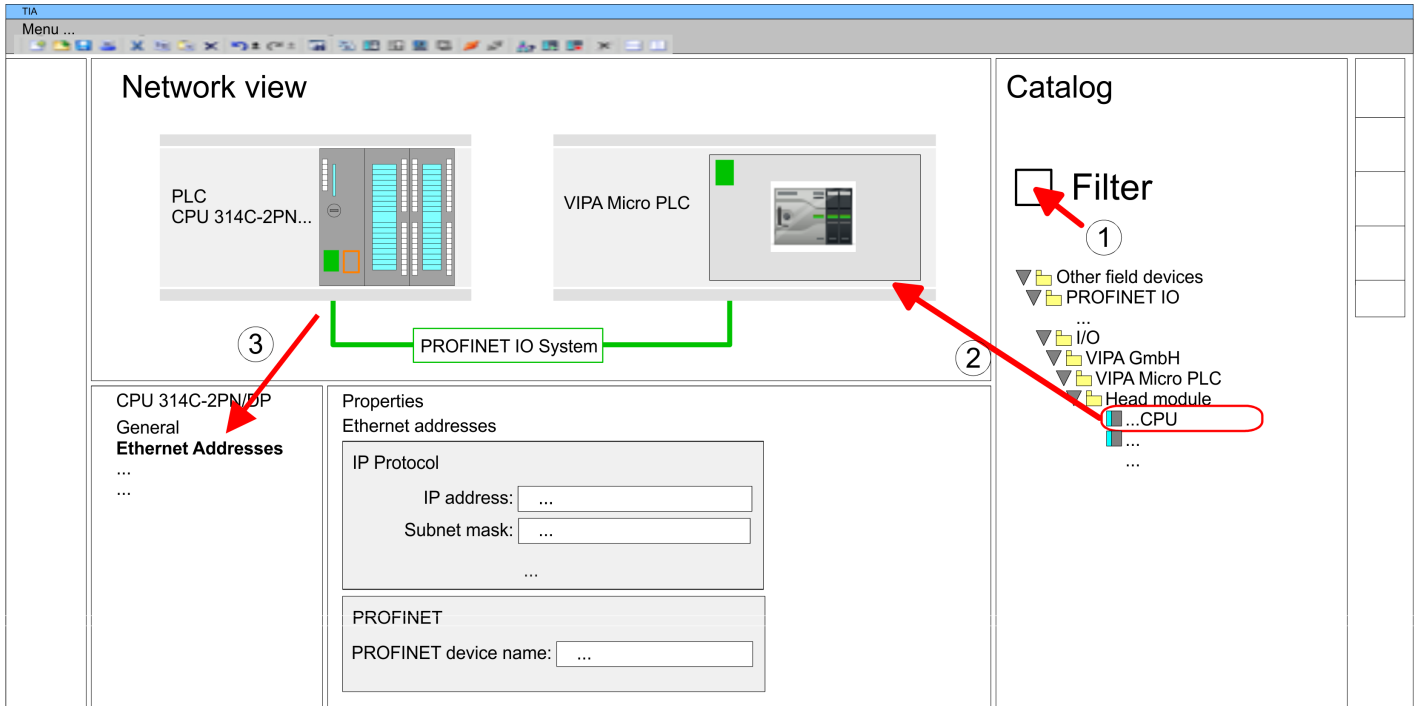

5. ➤ Select in the *Network view* the IO device 'VIPA MICRO PLC' and switch to the *Device overview*.
 ⇒ In the *Device overview* of the PROFINET IO device 'VIPA MICRO PLC' the CPU is already placed at slot 0.

Configuration of Ethernet PG/OP channel

1. ➤ As Ethernet PG/OP channel place at slot 4 the Siemens CP 343-1 (6GK7 343-1EX30 0XE0 V3.0).
2. ➤ Open the "Property" dialog by clicking on the CP 343-1EX30 and enter for the CP at "Properties" at "Ethernet address" the IP address data, which you have assigned before. You get valid IP address parameters from your system administrator.

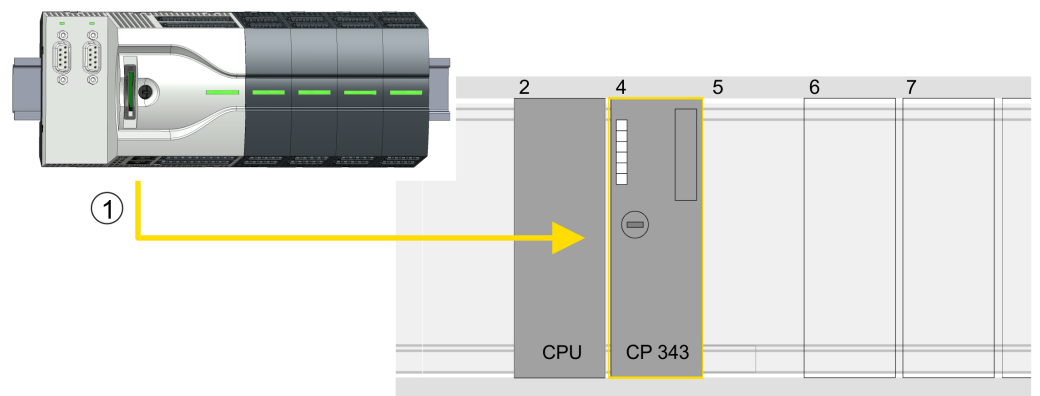

1 Ethernet PG/OP channel

Device overview

Module	...	Slot	...	Type	...
PLC ...		2		CPU 314C-2PN/DP	

MPI/DP interface	2 X1	MPI/DP interface
PROFINET interface	2 X2	PROFINET interface
...
CP 343-1	4	CP 343-1
...

Switch I/O periphery to Pulse Train

For parametrization of the input/output periphery and the *technological functions* the corresponding sub modules of the Siemens CPU 314C-2 PN/DP (314-6EH04-0AB0 V3.3) is to be used. For pulse train output, the sub module count must be switched to 'Pulse-width modulation'. If you are using a channel other than channel 0, you must adapt it in the hardware configuration and in your user program.

1. Double-click the counter sub module of the CPU 314C-2 PN/DP.
⇒ The dialog 'Properties' is opened.
2. For example, select 'channel 0' and select the function 'Pulse-width modulation' as 'Operating mode'.
3. Leave all values unchanged.

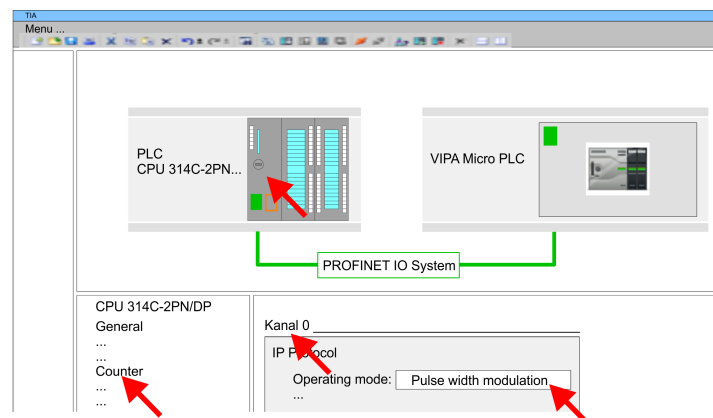

4. Click at the CPU and select 'Context menu → Compile → All'.

13.3.6.3 User program

Include library

1. Go to the service area of www.vipa.com.
2. Download the *Simple Motion Control* library from the download area at 'VIPA Lib'. The library is available as packed zip file for the corresponding TIA Portal version.
3. Start your un-zip application with a double click on the file ...TIA_Vxx.zip and copy all the files and folders in a work directory for the Siemens TIA Portal.
4. Switch to the *Project view* of the Siemens TIA Portal.
5. Choose "Libraries" from the task cards on the right side.
6. Click at "Global library".
7. Click on the free area inside the 'Global Library' and select 'Context menu → Retrieve library'.
8. Navigate to your work directory and load the file ...Simple Motion.zalxx.

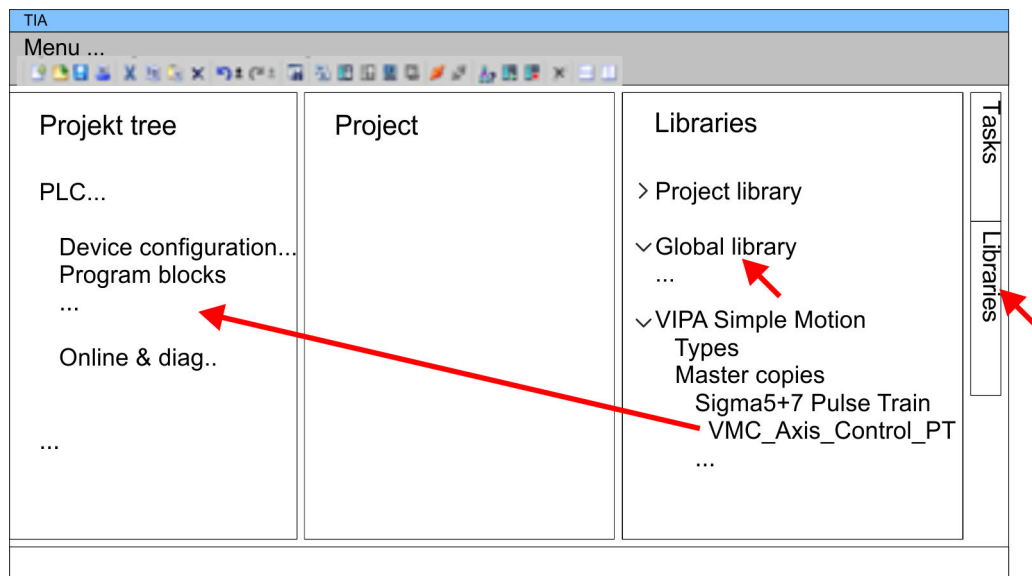
Copy blocks into project

➔ Copy the following block from the library into the "Program blocks" of the *Project tree* of your project.

- *Sigma5+7 Pulse Train*
 - FB 875 - VMC_AxisControl_PT ↗ *Chap. 13.3.7.1 'FB 875 - VMC_AxisControl_PT - Axis control via Pulse Train' page 423*

OB 1**Configuration of the axis**

1. ➔ Open in the *Project tree* within the CPU at '*Programming blocks*' the OB 1 and program the Call FB 875, DB 875.
 - ⇒ The dialog '*Add instance data block*' opens.
2. ➔ Set the number for the instance data block, if not already done, and close the dialog with [OK].
 - ⇒ The block call is created and the parameters are listed

3. ➤ Assign the following parameters for the sample project. In particular, consider the two conversion factors *FactorPosition* and *FactorVelocity*:

```
⇒ CALL FB    "VMC_AxisControl_PT" , "DI_AxisControl_PT"
           S_ChannelNumberPWM      := 0
           S_Ready                  := E 136.0
           S_Alarm                   := E 136.2
           FactorPosition             := 1024.0
           FactorVelocity             := 976.5625
           AxisEnable                 := M 100.1
           AxisReset                  := M 100.2
           StopExecute                := M 100.3
           MvVelocityExecute          := M 100.4
           MvRelativeExecute         := M 100.5
           JogPositive                := M 100.6
           JogNegative                := M 100.7
           PositionDistance           := MD 102
           Velocity                   := MD 106
           S_On                       := A 136.7
           S_Direction                := A 136.2
           S_AlarmReset               := A 136.6
           MinUserDistance            := MD 110
           MaxUserDistance            := MD 114
           MinUserVelocity            := MD 118
           MaxUserVelocity            := MD 122
           AxisReady                  := M 101.3
           AxisEnabled                := M 101.4
           AxisError                  := M 101.5
           AxisErrorID                := MW 126
           DriveError                 := M 101.6
           CmdActive                  := MB 128
           CmdDone                    := M 130.0
           CmdBusy                    := M 130.1
           CmdAborted                 := M 130.2
           CmdError                   := M 130.3
           CmdErrorID                 := MW 132
```

The addresses of *S_Ready* and *S_Alarm* are derived from the addresses of the inputs which are connected to the drive's digital outputs. These can be determined via the sub module 'DI24/DO16' of the CPU.

The addresses of *S_On*, *S_Direction* and *S_AlarmReset* are obtained from the addresses of the outputs which are connected to the digital inputs of the drive. These can be determined via the sub module 'DI24/DO16' of the CPU.

Sequence of operations

1. ➤ Select 'Edit → Compile' and transfer the project into your CPU. You can find more information on the transfer of your project in the online help of the Siemens TIA Portal.

⇒ You can take your application into operation now.



CAUTION!

Please always observe the safety instructions for your drive, especially during commissioning!

2. ➤ Bring your CPU into RUN and turn on your drive.
 ⇒ The FB 875 - VMC_AxisControl_PT is executed cyclically.
3. ➤ As soon as *AxisReady* = TRUE, you can use *AxisEnable* to enable the drive.

4. → You now have the possibility to control your drive via its parameters and to check its status. ↪ *Chap. 13.3.7.1 'FB 875 - VMC_AxisControl_PT - Axis control via Pulse Train' page 423*

Controlling the drive via HMI

There is the possibility to control your drive via an HMI. For this purpose, a predefined symbol library is available for Movicon to access the VMC_AxisControl_PT function module. ↪ *Chap. 13.8 'Controlling the drive via HMI' page 613*

13.3.7 Drive specific block

13.3.7.1 FB 875 - VMC_AxisControl_PT - Axis control via Pulse Train

13.3.7.1.1 Description

With the FB *VMC_AxisControl_PT* you can control axis, which are connected via Pulse Train. You can check the status of the drive, turn the drive on or off, or execute various motion commands. A separate memory area is located in the instance data of the block. You can control your axis by means of an HMI. ↪ *Chap. 13.8 'Controlling the drive via HMI' page 613*



The control of a pulse train drive happens exclusively with the FB 875 VMC_AxisControl_PT. PLCopen blocks are not supported!

Parameter

Parameter	Declaration	Data type	Description
S_Channel-NumberPWM	INPUT	INT	Channel number of the PWM output, which is used for the control of the Pulse Train input of the servo (signal PULS).
S_Ready	INPUT	BOOL	<ul style="list-style-type: none"> ■ Digital input for connecting the S_Ready signal (S-RDY) <ul style="list-style-type: none"> – TRUE: Servo is ready for the S_On signal.
S_Alarm	INPUT	BOOL	<ul style="list-style-type: none"> ■ Digital input for connecting the S_Alarm signal (ALM) <ul style="list-style-type: none"> – FALSE if the servo has detected an error.
FactorPosition	INPUT	REAL	Factor for converting the position of user units into drive units (increments) and back. ↪ <i>'FactorPosition' page 426</i>
FactorVelocity	INPUT	REAL	Factor for converting the velocity of user units into drive units (increments) and back. ↪ <i>'FactorVelocity' page 427</i>
AxisEnable	INPUT	BOOL	<ul style="list-style-type: none"> ■ Enable/disable axis <ul style="list-style-type: none"> – TRUE: The axis is enabled. – FALSE: The axis is disabled.
AxisReset	INPUT	BOOL	<ul style="list-style-type: none"> ■ Reset axis <ul style="list-style-type: none"> – Edge 0-1: Axis reset is performed. – The status of a reset, started with <i>AxisReset</i>, is not indicated at the outputs <i>CmdActive</i>, <i>CmdDone</i>, <i>CmdBusy</i>, <i>CmdAborted</i>, <i>CmdError</i> and <i>CmdErrorID</i>.
StopExecute	INPUT	BOOL	<ul style="list-style-type: none"> ■ Stop axis <ul style="list-style-type: none"> – Edge 0-1: Stopping of the axis is started. <p>Note: StopExecute = 1: No other command can be started!</p>

Usage Sigma-5/7 Pulse Train > Drive specific block

Parameter	Declaration	Data type	Description
MvVelocityExecute	INPUT	BOOL	<ul style="list-style-type: none"> ■ Start moving the axis <ul style="list-style-type: none"> – Edge 0-1: The axis is accelerated / decelerated to the speed specified.
MvRelativeExecute	INPUT	BOOL	<ul style="list-style-type: none"> ■ Start moving the axis <ul style="list-style-type: none"> – Edge 0-1: The relative positioning of the axis is started.
JogPositive	INPUT	BOOL	<p>Jog operation positive</p> <ul style="list-style-type: none"> ■ Drive axis with constant velocity in positive direction <ul style="list-style-type: none"> – Edge 0-1: Drive axis with constant velocity is started. – Edge 1-0: The axis is stopped.
JogNegative	INPUT	BOOL	<p>Jog operation negative</p> <ul style="list-style-type: none"> ■ Drive axis with constant velocity in negative direction <ul style="list-style-type: none"> – Edge 0-1: Drive axis with constant velocity is started. – Edge 1-0: The axis is stopped.
PositionDistance	INPUT	REAL	Absolute position or relative distance for <i>MvRelativeExecute</i> in [user units].
Velocity	INPUT	REAL	Velocity setting (signed value) in [user units / s].
S_ON	OUTPUT	BOOL	<ul style="list-style-type: none"> ■ Digital output for controlling the S_On signal (S-ON) <ul style="list-style-type: none"> – TRUE: turns on the servo. – FALSE: turns off the servo.
S_Direction	OUTPUT	BOOL	<ul style="list-style-type: none"> ■ Digital output for controlling the S_Direction signal (SIGN) <ul style="list-style-type: none"> – TRUE: Presetting of the direction of rotation positive direction for the servo. – FALSE: Presetting of the direction of rotation negative direction for the servo.
S_AlarmReset	OUTPUT	BOOL	<ul style="list-style-type: none"> ■ Digital output for controlling the S_AlarmReset signal (ALM-RST) <ul style="list-style-type: none"> – TRUE: Alarms are reset in the servo. – FALSE: Alarms in the servo remain.
MinUserDistance	OUTPUT	REAL	Minimum drive distance (1 increment) of the servo [user units].
MaxUserDistance	OUTPUT	REAL	Maximum drive distance (8388607 increments = maximum number of pulses of the PWM output) of the servo [user units].
MinUserVelocity	OUTPUT	REAL	Minimum speed (period duration = 65535µs = maximum period of the PWM output) of the servo [user units].
MaxUserVelocity	OUTPUT	REAL	Maximum speed (period duration = 20µs = minimum period duration of the PWM output) of the servo [user units].
AxisReady	OUTPUT	BOOL	<ul style="list-style-type: none"> ■ AxisReady <ul style="list-style-type: none"> – TRUE: The axis is ready to switch on. – FALSE: The axis is not ready to switch on. <ul style="list-style-type: none"> → Check and fix <i>AxisError</i> (see <i>AxisErrorID</i>). → Check and fix <i>DriveError</i>.

Parameter	Declaration	Data type	Description
AxisEnabled	OUTPUT	BOOL	<ul style="list-style-type: none"> ■ Status axis <ul style="list-style-type: none"> – TRUE: Axis is switched on and accepts motion commands. – FALSE: Axis is not switched on and does not accepts motion commands. ■ Conditions for <i>AxisEnabled</i> = TRUE <ul style="list-style-type: none"> – <i>AxisEnable</i> = TRUE – <i>S_Ready</i> = TRUE – <i>S_Alarm</i> = TRUE
AxisError	OUTPUT	BOOL	<ul style="list-style-type: none"> ■ Motion axis error <ul style="list-style-type: none"> – TRUE: An error has occurred. <p>Additional error information can be found in the parameter <i>AxisErrorID</i>.</p> <p>→ The axis is locked (<i>S_On</i> = FALSE and <i>AxisEnabled</i> = FALSE). Command is not executed.</p>
AxisErrorID	OUTPUT	WORD	<p>Additional error information</p> <p>🔗 <i>Chap. 13.10 'ErrorID - Additional error information' page 637</i></p>
DriveError	OUTPUT	BOOL	<ul style="list-style-type: none"> ■ Error on the drive <ul style="list-style-type: none"> – TRUE: An error has occurred. – → The axis is disabled.
CmdActive	OUTPUT	BYTE	<ul style="list-style-type: none"> ■ Command <ul style="list-style-type: none"> – 0: no Cmd active – 1: STOP – 2: MvVelocity – 3: MvRelative – 4: JogPos – 5: JogNeg
CmdDone	OUTPUT	BOOL	<ul style="list-style-type: none"> ■ Status Done <ul style="list-style-type: none"> – TRUE: Job ended without error.
CmdBusy	OUTPUT	BOOL	<ul style="list-style-type: none"> ■ Status busy <ul style="list-style-type: none"> – TRUE: Job is running.
CmdAborted	OUTPUT	BOOL	<ul style="list-style-type: none"> ■ Status Aborted <ul style="list-style-type: none"> – TRUE: The job was aborted during processing by another job. <p>Note: <i>CmdAborted</i> is reset when a Cmd is started</p>
CmdError	OUTPUT	BOOL	<ul style="list-style-type: none"> ■ Status Error <ul style="list-style-type: none"> – TRUE: An error has occurred. The axis is disabled <p>Additional error information can be found in the parameter <i>CmdErrorID</i>.</p>
CmdErrorID	OUTPUT	WORD	<p>Additional error information</p> <p>🔗 <i>Chap. 13.10 'ErrorID - Additional error information' page 637</i></p>

13.3.7.1.2 Conversion factors

FactorPosition

The calculation of *FactorPosition* is only valid if servo parameter *Reference Pulse Multiplier (Pn218)* = 1.

$$FactorPosition = \frac{Resolution}{Numerator} \cdot Denominator$$

FactorPosition - Factor for converting the position of user units into drive units (increments) and back.

Resolution - Number of increments per user unit

Numerator - Numerator: Electronic Gear Ratio (Pn20E) of the servo parameter

Denominator - Denominator: Electronic Gear Ratio (Pn210) of the servo parameter

Example User unit for position = 1 revolution

FactorPosition - Factor for converting the position of user units into drive units (increments) and back.

Resolution - Number of increments per user unit

$$Resolution = 2^{20} = 1048576$$

Numerator - Numerator: Electronic Gear Ratio (Pn20E) of the servo parameter

$$Numerator = 1024$$

Denominator - Denominator: Electronic Gear Ratio (Pn210) of the servo parameter

$$Denominator = 1$$

$$FactorPosition = \frac{Resolution}{Numerator} \cdot Denominator$$

$$FactorPosition = \frac{1048576}{1024} \cdot 1 = 1024$$

Example minimum distance

MinPos - Minimum distance in rotations

Resolution - Number of increments per user unit

$$Resolution = 2^{20} = 1048576$$

Numerator - Numerator: Electronic Gear Ratio (Pn20E) of the servo parameter

$$Numerator = 1024$$

Period - Minimum period

$$Period = 1$$

$$MinPos = Numerator \cdot \frac{Period}{Resolution}$$

$$MinPos = 1024 \cdot \frac{1}{1048576} = \frac{1}{1024}$$

Example maximum distance

MaxPos - Maximum distance in revolutions

Resolution - Number of increments per user unit

$$\text{Resolution} = 2^{20} = 1048576$$

Numerator - Numerator: Electronic Gear Ratio (Pn20E) of the servo parameter

$$\text{Numerator} = 1024$$

Period - Maximum period

$$\text{Period} = 8388607$$

$$\text{MaxPos} = \text{Numerator} \cdot \frac{\text{Period}}{\text{Resolution}}$$

$$\text{MaxPos} = 1024 \cdot \frac{8388607}{1048576} = 8192$$

FactorVelocity

The calculation of FactorVelocity is only valid if servo parameter Reference Pulse Multiplier (Pn218) = 1.

$$\text{FactorVelocity} = \text{Time} \cdot \frac{\frac{\text{Numerator}}{\text{Denominator}}}{\text{Resolution}}$$

Time - Time for 1 revolution in μs

Numerator - Numerator: Electronic Gear Ratio (Pn20E) of the servo parameter

Denominator - Denominator: Electronic Gear Ratio (Pn210) of the servo parameter

Resolution - Number of increments per user unit

Example User unit for velocity = revolution/min

FactorVelocity - Factor for converting of user units into drive units (increments) and back.

Time - Time for 1 revolution in μs

$$Time = 1\text{min} = 60 \cdot 10^6 \mu\text{s}$$

Numerator - Numerator: Electronic Gear Ratio (Pn20E) of the servo parameter

$$Numerator = 1024$$

Denominator - Denominator: Electronic Gear Ratio (Pn210) of the servo parameter

$$Denominator = 1$$

Resolution - Number of increments per user unit

$$Resolution = 2^{20} = 1048576$$

$$FactorVelocity = Time \cdot \frac{\frac{Numerator}{Denominator}}{Resolution}$$

$$FactorVelocity = 60 \cdot 10^6 \cdot \frac{\frac{1024}{1}}{1048576} = \frac{60 \cdot 10^6}{1024} = 58593,75$$

Example User unit for velocity = revolution/s

FactorVelocity - Factor for converting of user units into drive units (increments) and back.

Time - Time for 1 revolution in μs

$$Time = 1\text{s} = 10^6 \mu\text{s}$$

Numerator - Numerator: Electronic Gear Ratio (Pn20E) of the servo parameter

$$Numerator = 1024$$

Denominator - Denominator: Electronic Gear Ratio (Pn210) of the servo parameter

$$Denominator = 1$$

Resolution - Number of increments per user unit

$$Resolution = 2^{20} = 1048576$$

$$FactorVelocity = Time \cdot \frac{\frac{Numerator}{Denominator}}{Resolution}$$

$$FactorVelocity = 10^6 \cdot \frac{\frac{1024}{1}}{1048576} = \frac{10^6}{1024} = 976,5625$$

Minimum velocity for revolutions/min

MinVel - Minimum velocity in revolutions/min

FactorVelocity - Factor for converting of user units into drive units (increments) and back.

$$\text{MinVel} = \frac{\text{FactorVelocity}}{65535} = \frac{58593,75}{65535} = 0,89$$

Maximum velocity for revolutions/min

MaxVel - Maximum velocity in revolutions/min

FactorVelocity - Factor for converting of user units into drive units (increments) and back.

$$\text{MaxVel} = \frac{\text{FactorVelocity}}{20} = \frac{58593,75}{20} = 2929,69$$

13.3.7.1.3 Functionality**Switch the drive on or off**

- The *AxisEnable* input is used to switch an axis on or off.
- Switching on is only possible if *AxisReady* = TRUE, i.e. the axis is ready to switch on.
- As soon as the axis is switched on, this is indicated by the status information *AxisEnabled*.
- If the axis has an error, this is indicated by the status information *AxisError*. For more information refer to *AxisErrorID*.

Acknowledge drive errors

- With *AxisReset* you can acknowledge errors on the drive.
- Errors are reported via *DriveError*.

Stop axis - MC_STOP

- You can stop an axis in motion by setting *StopExecute*.
- As long as *StopExecute* is set, no further pulses are generated and all commands are blocked.

Velocity mode - MC_Move-Velocity

- Precondition: The drive is switched on and *AxisReady* = TRUE.
- With *MvVelocityExecute*, you can bring the axis to rotate with constant velocity.
- You specify the velocity via *Velocity*.
- By setting 0, the axis stops as well as with *StopExecute*.
- The direction of rotation is determined by the sign of *Velocity*.
- The *Velocity* value can be 0 or $\text{MinUserVelocity} \leq \text{Velocity} \leq \text{MaxUserVelocity}$.

Relative positioning - MC_MoveRelative

- Precondition: The drive is switched on and *AxisReady* = TRUE.
- The relative positioning happens by *MvRelativeExecute*.
- You can specify the distance in user units via *PositionDistance*.
- The direction of rotation is determined by the sign of *PositionDistance*.
- You specify the velocity via *Velocity*.
- By setting *StopExecute*, you can stop a running command.

Usage inverter drive via PWM > Set the parameters on the inverter drive

Jog mode

- Precondition: The drive is switched on and *AxisReady* = TRUE.
- With an edge 0-1 at *JogPositive* or *JogNegative*, you can control your drive in jog mode. In this case, a jogging command is executed in the corresponding direction of rotation.
- You specify the velocity via *Velocity*. The sign is not relevant.
- With an edge 1-0 at *JogPositive* or *JogNegative* respectively by setting *StopExecute* the axis is stopped.

13.4 Usage inverter drive via PWM

13.4.1 Overview

Precondition

- SPEED7 Studio from V1.7.1
or
- Siemens SIMATIC Manager from V 5.5, SP2 & *Simple Motion Control Library*
or
- Siemens TIA Portal V 14 & *Simple Motion Control Library*
- System MICRO or System SLIO CPU with PWM output, such as CPU M13-CCF0000 or CPU 013-CCF0R00.
- Inverter drive with PWM input e.g. *V1000*.

Steps of configuration

1. ➤ Setting parameters on the inverter drive
 - The setting of the parameters happens by means of the software tool *Drive Wizard+*.
2. ➤ Hardware configuration in the *VIPA SPEED7 Studio*, Siemens SIMATIC Manager or Siemens TIA Portal.
 - Configuring the CPU.
3. ➤ Programming in the *VIPA SPEED7 Studio*, Siemens SIMATIC Manager or Siemens TIA Portal.
 - *VMC_AxisControlV1000PWM* block for configuration and communication with the axis, which is connected via PWM.

13.4.2 Set the parameters on the inverter drive



CAUTION!

Before the commissioning, you have to adapt your inverter drive to your application with the *Drive Wizard+* software tool! More may be found in the manual of your drive.

The following table shows all parameters, which do not correspond to the default values. The following parameters must be set via *Drive Wizard+* to match the *Simple Motion Control Library*. This is followed by a table with parameters, which can be adapted as a function of the application.

No.	Parameters that differ from the standard	Setting for <i>Simple Motion Control Library</i>
B1-01	Reference selection	■ 4: Pulse train input
B1-02	Operation method selection	■ 1: Control circuit terminal
H1-01	Terminal S1 function selection	■ 0040: Forward Run Command

Usage inverter drive via PWM > Set the parameters on the inverter drive

No.	Parameters that differ from the standard	Setting for <i>Simple Motion Control Library</i>
H1-02	Terminal S2 function selection	■ 0041: Reverse Run Command
H2-01	Terminal MA/MB-MC selection	■ 000E: Fault
H2-02	P1 terminal selection	■ 0006
H6-01	Pulse train input function selection	■ 0: Frequency reference
H6-02	Pulse train input scaling	■ 20000Hz
H6-03	Pulse train input gain	■ 100.0%
H6-04	Pulse train input bias	■ 0.0%
H6-05	Pulse train input filter time	■ 0.10s
H6-06	Pulse train monitor selection	■ 102: Output frequency
H6-07	Pulse train monitor scaling	■ 20000Hz

No.	Parameters depending on the application	Example
C1-01	Acceleration time 1	■ 10.00s
C1-02	Deceleration time 1	■ 10.00s
C1-10	Accel/Decel time setting unit	■ 0: 0.01- second units
C1-11	Accel/Decel switching frequency	■ 0.0Hz
O1-02	Monitor selection after power up	■ 1: Frequency reference
O1-03	Display scaling	■ 2: min-1 unit



For all settings to be accepted, you must restart the inverter drive after parametrization!

13.4.3 Wiring

13.4.3.1 Connecting the V1000 inputs

Sample application

The following figure shows an example application for connecting the inputs of a V1000 inverter drive via PWM to a System MICRO CPU M13C. In this example the PWM channel 0 (X2 - pin 8) is connected. Please use X2 - pin 7 to connect to channel 1.

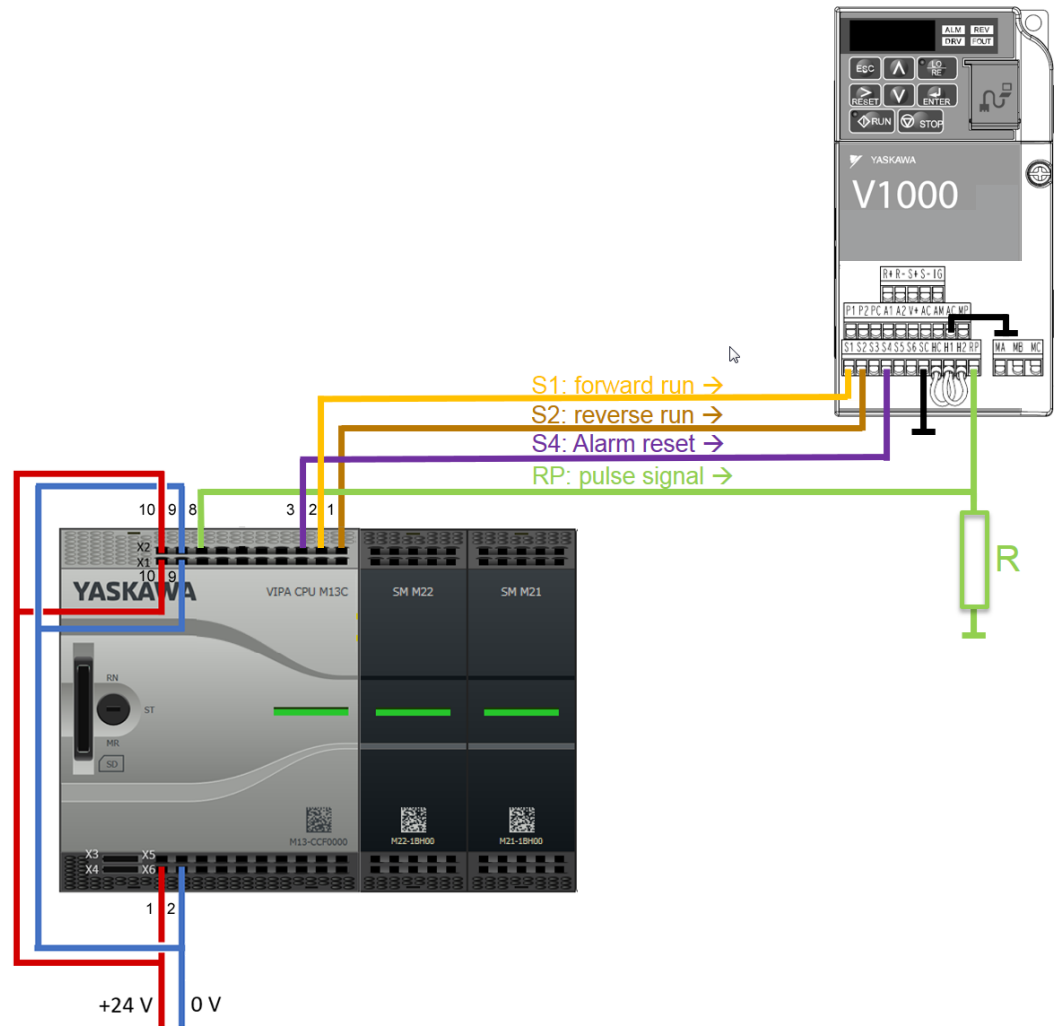

- R Resistor
 - Value: max. 470Ω
 - Power dissipation: min. 0.6W
 - Resistance example: Metal film resistor 0207 wired with 0.6W power dissipation
 - Cable length max. 20m

13.4.3.2 Connecting the V1000 outputs

Sample application

The following figure shows an example application for connecting the outputs of a V1000 inverter drive to a System MICRO CPU M13C.

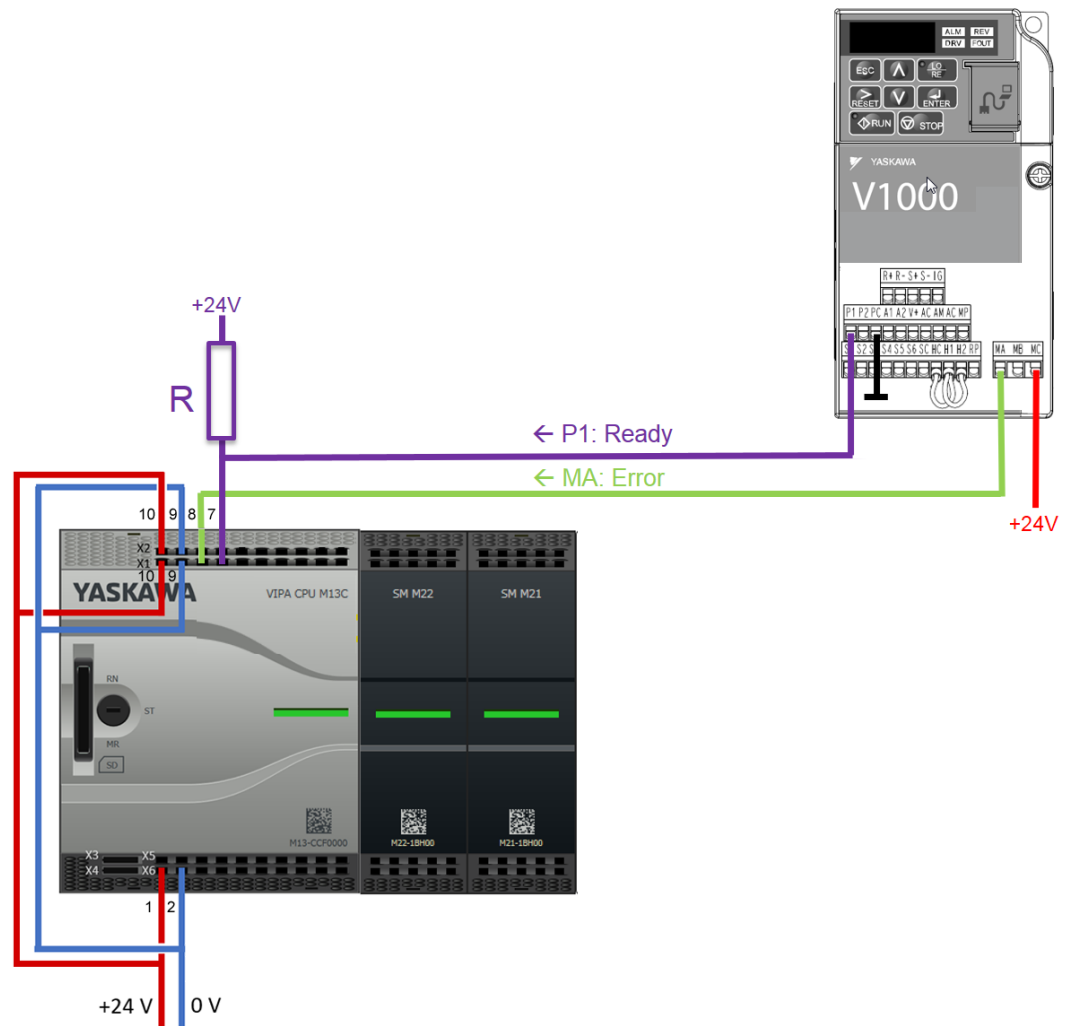

- R Resistor
- Value: 4.7kΩ
- Power dissipation: min. 0.25W
- Resistance example: Carbon film resistor 0207 wired with 0.25W power dissipation

13.4.4 Usage in VIPA SPEED7 Studio

13.4.4.1 Hardware configuration

Add CPU in the project

Please use the SPEED7 Studio V1.7.1 and up for the configuration.

If you are using a channel other than channel 0, you must adapt it in the hardware configuration and in your user program.

1. Start the *SPEED7 Studio*.

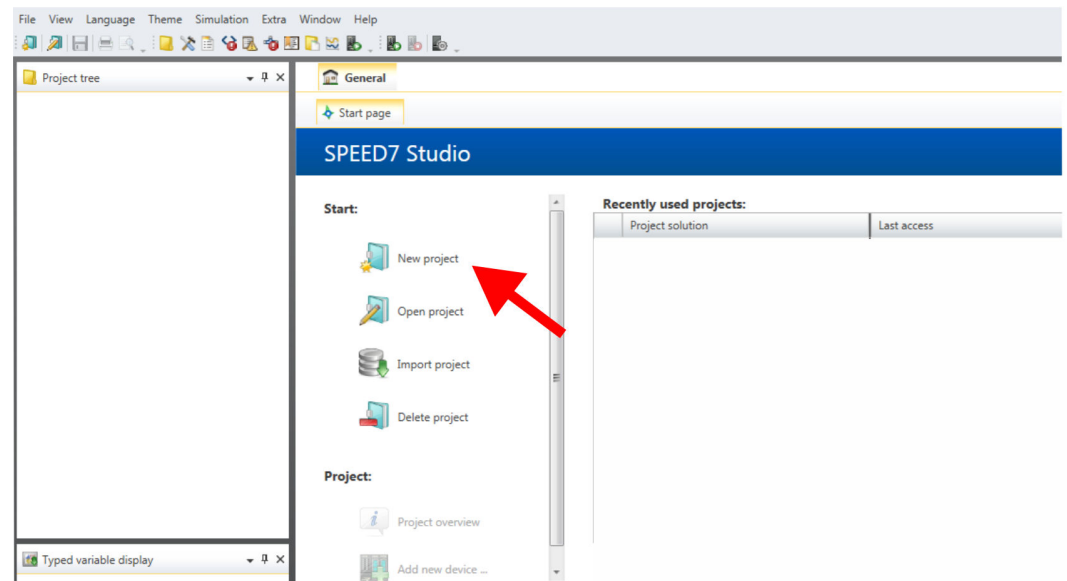

2. Create a new project at the start page with 'New project' and assign a 'Project name'.

⇒ A new project is created and the view 'Devices and networking' is shown.

3. Click in the *Project tree* at 'Add new device ...'.

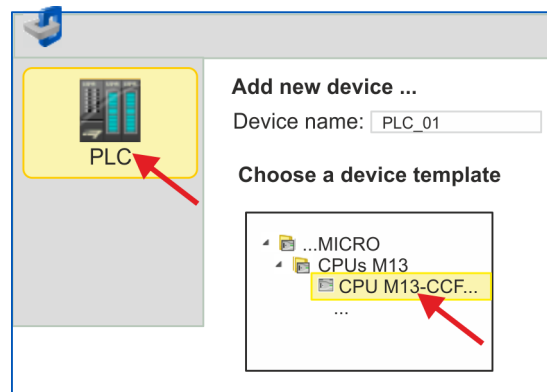
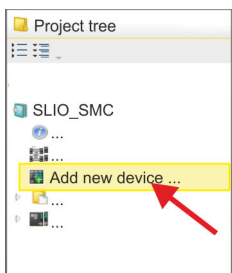

⇒ A dialog for device selection opens.

4. Select from the 'Device templates' your CPU with PWM functionality like the System MICRO CPU M13-CCF0000 and click at [OK].

⇒ The CPU is inserted in 'Devices and networking' and the 'Device configuration' is opened.

Configuration of Ethernet PG/OP channel

1. Click in the *Project tree* at '*Devices and networking*'.
⇒ You will get a graphical object view of your CPU.

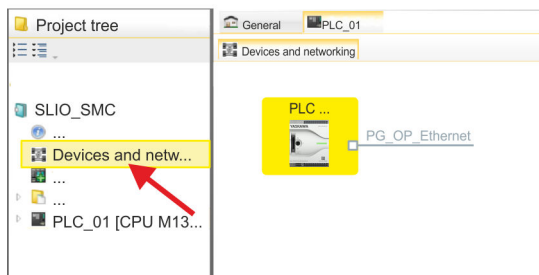

2. Click at the network '*PG_OP_Ethernet*'.
3. Select '*Context menu* → *Interface properties*'.
⇒ A dialog window opens. Here you can enter the IP address data for your Ethernet PG/OP channel. You get valid IP address parameters from your system administrator.
4. Confirm with [OK].
⇒ The IP address data are stored in your project listed in '*Devices and networking*' at '*Local components*'.
After transferring your project your CPU can be accessed via Ethernet PG/OP channel with the set IP address data.

Switch I/O periphery to PWM

For parametrization of the I/O periphery and the *technological functions* the corresponding sub modules of the CPU are to be used. For PWM output, the sub module count must be switched to '*Pulse-width modulation*'.

1. Click in the *Project tree* at '*PLC... > Device configuration*'.
2. Click in the '*Device configuration*' at '*-X27 Count*' and select '*Context menu* → *Components properties*'.
⇒ The properties dialog is opened.
3. For example, select '*channel 0*' and select the function '*Pulse-width modulation*' as '*Operating mode*'.

Usage inverter drive via PWM > Usage in VIPA SPEED7 Studio

- The operating parameters required for PWM are internally adapted to the corresponding values. Leave all values unchanged.

Slot	Component
0	CPU ...
-X2	...
-X3	...
-X27	Count

- Close the dialog with [OK].
- Select 'Project → Compile all'.

13.4.4.2 User program Copy block to project

- In the 'Catalog', open the 'Simple Motion Control' library at 'Blocks' and drag and drop the following blocks into 'Program blocks' of the Project tree:
 - V1000 PWM
 - FB885 – VMC_AxisControlV1000PWM ↪ Chap. 13.4.7.1 'FB 885 - VMC_AxisControlV1000_PWM - Axis control over PWM' page 449

OB 1

Configuration of the axis

If you are using a channel other than channel 0, you must adapt it in the hardware configuration and in your user program.

1. Open in 'Project tree → ...CPU... → PLC program → Program blocks' the OB 1 and program the Call FB 885, DB 885.

⇒ The dialog 'Add instance data block' opens.

2. Set the number for the instance data block, if not already done, and close the dialog with [OK].

⇒ The block call is created and the parameters are listed.

3. Assign the following parameters for the sample project.

```
⇒ CALL FB "VMC_AxisControlV1000PWM" ,
   "VMC_AxisCtrlV1000PWM_885"
   I_ChannelNumberPWM := "Ax1_I_ChannelNumberPWM"
   I_MA_Alarm          := "Ax1_MA_Alarm"
   I_P1_Ready         := "I_P1_Ready"
   MaxVelocityDrive   := 1.000000e+002
   AxisEnable         := "Ax1_AxisEnable"
   AxisReset          := "Ax1_AxisReset"
   StopExecute       := "Ax1_StopExecute"
   MvVelocityExecute := "Ax1_MvVelExecute"
   JogPositive       := "Ax1_JogPositive"
   JogNegative       := "Ax1_JogNegative"
   Velocity          := "Ax1_Velocity"
   I_S1_ForwardRun   := "Ax1_S1_ForwardRun"
   I_S2_ReverseRun   := "Ax1_S2_ReverseRun"
   I_S4_AlarmReset   := "Ax1_S4_AlarmReset"
   MinUserVelocity   := "Ax1_MinUserVelocity"
   MaxUserVelocity   := "Ax1_MaxUserVelocity"
   AxisReady         := "Ax1_AxisReady"
   AxisEnabled       := "Ax1_AxisEnabled"
   AxisError         := "Ax1_AxisError"
   AxisErrorID       := "Ax1_AxisErrorID"
   DriveError        := "Ax1_DriveError"
   CmdActive         := "Ax1_CmdActive"
   CmdDone           := "Ax1_CmdDone"
   CmdBusy           := "Ax1_CmdBusy"
   CmdAborted        := "Ax1_CmdAborted"
   CmdError          := "Ax1_CmdError"
   CmdErrorID        := "Ax1_CmdErrorID"
```

The addresses of *I_P1_Ready* and *I_MA_Alarm* are derived from the addresses of the inputs which are connected to the digital outputs of the drive. These can be determined via the sub module 'X25 DI/DIO' of the CPU.



The addresses of *I_S1_ForwardRun*, *I_S2_ReverseRun* and *I_S4_AlarmReset* are obtained from the addresses of the outputs which are connected to the digital inputs of the drive. These can be determined via the sub module 'X25 DI/DIO' of the CPU.

Sequence of operations

1.  Select '*Project* → *Compile all*' and transfer the project into your CPU. You can find more information on the transfer of your project in the online help of the *SPEED7 Studio*.
⇒ You can take your application into operation now.

**CAUTION!**

Please always observe the safety instructions for your drive, especially during commissioning!







2.  Bring your CPU into RUN and turn on your drive.
⇒ The FB 885 - VMC_AxisControlV1000PWM is executed cyclically.
3.  As soon as *AxisReady* = TRUE, you can use *AxisEnable* to enable the drive.
4.  You now have the possibility to control your drive via its parameters and to check its status. ↪ *Chap. 13.4.7.1 'FB 885 - VMC_AxisControlV1000_PWM - Axis control over PWM' page 449*

13.4.5 Usage in Siemens SIMATIC Manager**13.4.5.1 Precondition****Overview**

- Please use for configuration the Siemens SIMATIC Manager V 5.5 SP2 and up.
- The configuration of the VIPA CPU with PWM functionality happens in the Siemens SIMATIC Manager by means of a virtual PROFINET IO device.
- The PROFINET IO Device is to be installed in the hardware catalog by means of a GSDML.

Installing the VIPA IO device

The installation of the PROFINET VIPA IO device happens in the hardware catalog with the following approach:

1.  Go to the service area of www.vipa.com.
2.  Download the configuration file for your CPU from the download area via '*Config files* → *PROFINET*'.
3.  Extract the file into your working directory.
4.  Start the Siemens hardware configurator.
5.  Close all the projects.
6.  Select '*Options* → *Install new GSD file*'.
7.  Navigate to your working directory and install the according GSDML file.
⇒ After the installation according PROFINET IO device can be found at '*PROFINET IO* → *Additional field devices* → *I/O* → *VIPA ...*'.

13.4.5.2 Hardware configuration

Add CPU in the project

Slot	Module
1	
2	CPU 314C-2PN/DP
X1	MPI/DP
X2	PN-IO
X2...	Port 1
X2...	Port 2
...	...
3	

To be compatible with the Siemens SIMATIC Manager the following steps should be executed:

1. Start the Siemens hardware configurator with a new project.
2. Insert a profile rail from the hardware catalog.
3. Place at 'Slot'-Number 2 the CPU 314C-2 PN/DP (314-6EH04-0AB0 V3.3).
4. Click at the sub module 'PN-IO' of the CPU.
5. Select 'Context menu → Insert PROFINET IO System'.

Slot	Module
1	
2	CPU ...
X...	PN-IO
3	



6. Create with [New] a new sub net and assign valid address data.
7. Click at the sub module 'PN-IO' of the CPU and open with 'Context menu → Properties' the properties dialog.
8. Enter at 'General' a 'Device name'. The device name must be unique at the Ethernet subnet.

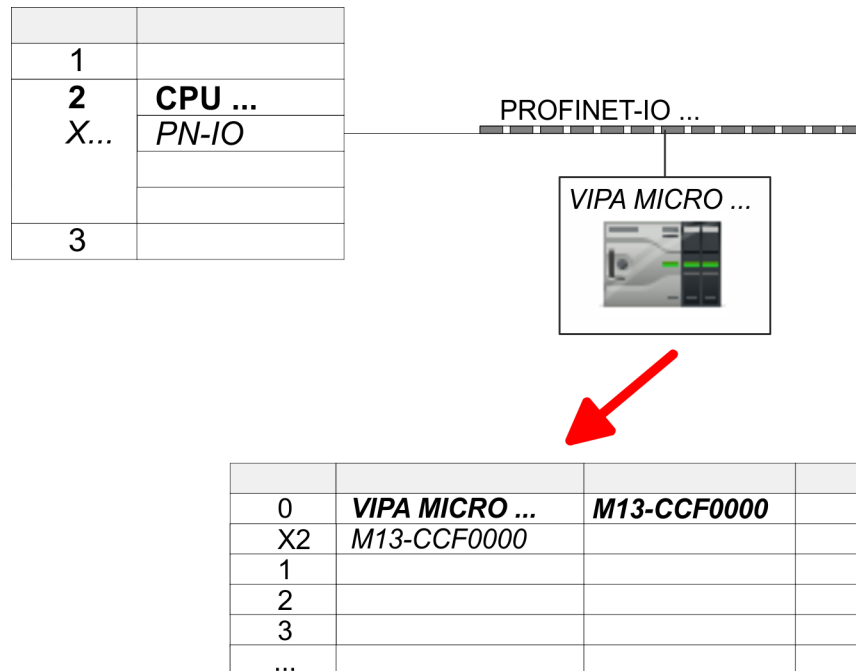

9. ➤ Navigate in the hardware catalog to the directory 'PROFINET IO ➔ Additional field devices ➔ I/O ➔ VIPA ...' and connect e.g. for the System MICRO the IO device 'M13-CCF0000' to your PROFINET system.
 - ⇒ In the *Device overview* of the PROFINET IO device 'VIPA MICRO PLC' the CPU is already placed at slot 0.

Configuration of Ethernet PG/OP channel

Slot	Module
1	
2	CPU ...
X...	PN-IO
3	
4	343-1EX30
5	
...	

1. ➤ Place for the Ethernet PG/OP channel at slot 4 the Siemens CP 343-1 (SIMATIC 300 \ CP 300 \ Industrial Ethernet \ CP 343-1 \ 6GK7 343-1EX30 0XE0 V3.0).
2. ➤ Open the properties dialog by clicking on the CP 343-1EX30 and enter for the CP at 'Properties' the IP address data. You get valid IP address parameters from your system administrator.
3. ➤ Assign the CP to a 'Subnet'. The IP address data are not accepted without assignment!

Switch I/O periphery to PWM

For parametrization of the input/output periphery and the *technological functions* the corresponding sub modules of the Siemens CPU 314C-2 PN/DP (314-6EH04-0AB0 V3.3) is to be used. For PWM output, the sub module count must be switched to 'Pulse-width modulation'. If you are using a channel other than channel 0, you must adapt it in the hardware configuration and in your user program.

1. ➤ Double-click the counter sub module of the CPU 314C-2 PN/DP.
 - ⇒ The dialog 'Properties' is opened.
2. ➤ For example, select 'channel 0' and select the function 'Pulse-width modulation' as 'Operating mode'.

3. Leave all values unchanged.

1	
2	CPU 314C-2 PN/DP
X1	MPI/DP
X2	PN-IO
X2 P1 R	Port 1
X2 P2 R	Port 2
2.5	DI24/DO16
2.6	AI5/AO2
2.7	Count
2.8	Position
3	

PROFINET-IO ...

VIPA MICRO...

Properties - Count

Channel: Operating mode:

4. Close the dialog with [OK].
5. Select 'Station → Save and compile'.
6. Close the hardware configurator.

13.4.5.3 User program

Include library

1. Go to the service area of www.vipa.com.
2. Download the *Simple Motion Control* library from the download area at 'VIPA Lib'.
3. Open the dialog window for ZIP file selection via 'File → Retrieve'.
4. Select the according ZIP file and click at [Open].
5. Specify a target directory in which the blocks are to be stored and start the unzip process with [OK].

Copy blocks into project

- Open the library after unzipping and drag and drop the following blocks into 'Blocks' of your project:
- V1000 PWM
 - FB885 – VMC_AxisControlV1000PWM ↗ Chap. 13.4.7.1 'FB 885 - VMC_AxisControlV1000_PWM - Axis control over PWM' page 449

OB 1

Configuration of the axis

If you are using a channel other than channel 0, you must adapt it in the hardware configuration and in your user program.

1. Open in the *Project tree* within the CPU at 'PLC program', 'Programming blocks' the OB 1 and program the Call FB 885, DB 885.
 - ⇒ The dialog 'Add instance data block' opens.
2. Set the number for the instance data block, if not already done, and close the dialog with [OK].
 - ⇒ The block call is created and the parameters are listed

3. Assign the following parameters for the sample project:

```

⇒ CALL FB "VMC_AxisControlV1000PWM" ,
      "VMC_AxisCtrlV1000PWM_885"
      I_ChannelNumberPWM := "Ax1_I_ChannelNumberPWM"
      I_MA_Alarm          := "Ax1_MA_Alarm"
      I_P1_Ready         := "I_P1_Ready"
      MaxVelocityDrive   := 1.000000e+002
      AxisEnable         := "Ax1_AxisEnable"
      AxisReset          := "Ax1_AxisReset"
      StopExecute        := "Ax1_StopExecute"
      MvVelocityExecute  := "Ax1_MvVelExecute"
      JogPositive        := "Ax1_JogPositive"
      JogNegative        := "Ax1_JogNegative"
      Velocity           := "Ax1_Velocity"
      I_S1_ForwardRun    := "Ax1_S1_ForwardRun"
      I_S2_ReverseRun    := "Ax1_S2_ReverseRun"
      I_S4_AlarmReset    := "Ax1_S4_AlarmReset"
      MinUserVelocity    := "Ax1_MinUserVelocity"
      MaxUserVelocity    := "Ax1_MaxUserVelocity"
      AxisReady          := "Ax1_AxisReady"
      AxisEnabled        := "Ax1_AxisEnabled"
      AxisError          := "Ax1_AxisError"
      AxisErrorID        := "Ax1_AxisErrorID"
      DriveError         := "Ax1_DriveError"
      CmdActive          := "Ax1_CmdActive"
      CmdDone            := "Ax1_CmdDone"
      CmdBusy            := "Ax1_CmdBusy"
      CmdAborted         := "Ax1_CmdAborted"
      CmdError           := "Ax1_CmdError"
      CmdErrorID        := "Ax1_CmdErrorID"

```

The addresses of *I_P1_Ready* and *I_MA_Alarm* are derived from the addresses of the inputs which are connected to the digital outputs of the drive. These can be determined via the sub module '*-X25 DI/DIO*' of the CPU.

The addresses of *I_S1_ForwardRun*, *I_S2_ReverseRun* and *I_S4_AlarmReset* are obtained from the addresses of the outputs which are connected to the digital inputs of the drive. These can be determined via the sub module '*-X25 DI/DIO*' of the CPU.

Sequence of operations**1.** Choose the Siemens SIMATIC Manager and transfer your project into the CPU.

⇒ You can take your application into operation now.

**CAUTION!**

Please always observe the safety instructions for your drive, especially during commissioning!

2. Bring your CPU into RUN and turn on your drive.

⇒ The FB 885 - VMC_AxisControlV1000PWM is executed cyclically.

3. As soon as *AxisReady* = TRUE, you can use *AxisEnable* to enable the drive.**4.** You now have the possibility to control your drive via its parameters and to check its status. ↪ *Chap. 13.4.7.1 'FB 885 - VMC_AxisControlV1000_PWM - Axis control over PWM' page 449*

13.4.6 Usage in Siemens TIA Portal

13.4.6.1 Precondition

Overview

- Please use the Siemens TIA Portal V 14 and up for the configuration.
- The configuration of the VIPA CPU with PWM functionality happens in the Siemens TIA Portal by means of a virtual PROFINET IO device.
- The PROFINET IO Device is to be installed in the hardware catalog by means of a GSDML.

Installing the VIPA IO device

The installation of the PROFINET VIPA IO device happens in the hardware catalog with the following approach:

1. ➤ Go to the service area of www.vipa.com.
2. ➤ Download the according file for your system - here System MICRO from the download area via '*Config files* ➔ *PROFINET*'.
3. ➤ Extract the file into your working directory.
4. ➤ Start the Siemens TIA Portal.
5. ➤ Close all the projects.
6. ➤ Switch to the *Project view*.
7. ➤ Select '*Options* ➔ *Install general station description file (GSD)*'.
8. ➤ Navigate to your working directory and install the according GSDML file.
 - ⇒ After the installation the hardware catalog is refreshed and the Siemens TIA Portal is closed.

After restarting the Siemens TIA Portal the according PROFINET IO device can be found at *Other field devices* > *PROFINET* > *IO* > *VIPA GmbH* > *VIPA MICRO PLC*.



Thus, the VIPA components can be displayed, you have to deactivate the "Filter" of the hardware catalog.

13.4.6.2 Hardware configuration

Add CPU in the project

To be compatible with the Siemens SIMATIC TIA Portal the following steps should be executed:

1. ➤ Start the Siemens TIA Portal with a new project.
2. ➤ Switch to the *Project view*.
3. ➤ Click in the *Project tree* at '*Add new device*'.

4. ➤ Select the following CPU in the input dialog:
SIMATIC S7-300 > CPU 314C-2 PN/DP (314-6EH04-0AB0 V3.3)
⇒ The CPU is inserted with a profile rail.

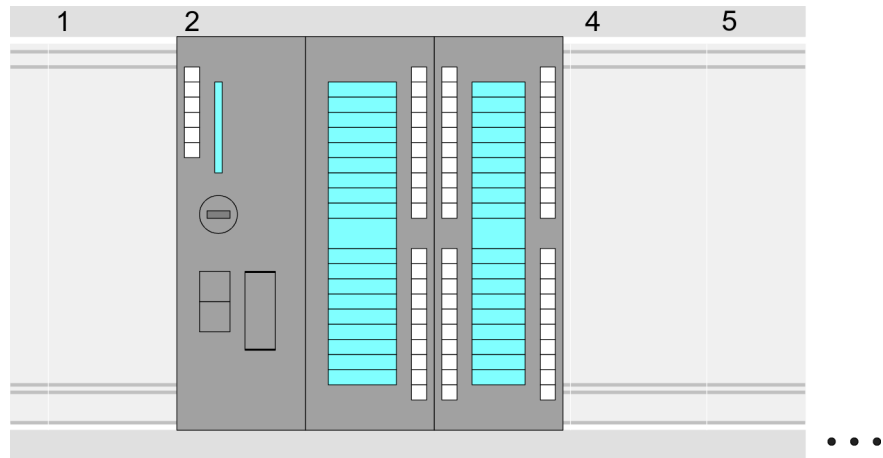

Device overview:

Module	...	Slot	...	Type	...
PLC...		2		CPU 314C-2PN/DP	
MPI interface...		2 X1		MPI/DP interface	
PROFINET inter- face...		2 X2		PROFINET interface	
DI24/DO16...		2 5		DI24/DO16	
AI5/AO2...		2 6		AI5/AO2	
Count...		2 7		Count	
...					

Connection CPU as PROFINET IO device

1. ➤ Switch in the *Project area* to 'Network view'.
2. ➤ After installing the GSDML the IO device for the SLIO CPU may be found in the hardware catalog at *Other field devices > PROFINET > IO > VIPA GmbH > VIPA MICRO PLC*. Connect the slave system to the CPU by dragging&dropping it from the hardware catalog to the *Network view* and connecting it via PROFINET to the CPU.
3. ➤ Click in the *Network view* at the PROFINET part of the Siemens CPU and enter at valid IP address data in 'Properties' at 'Ethernet address' in the area 'IP protocol'.
4. ➤ Enter at 'PROFINET' a 'PROFINET device name'. The device name must be unique at the Ethernet subnet.

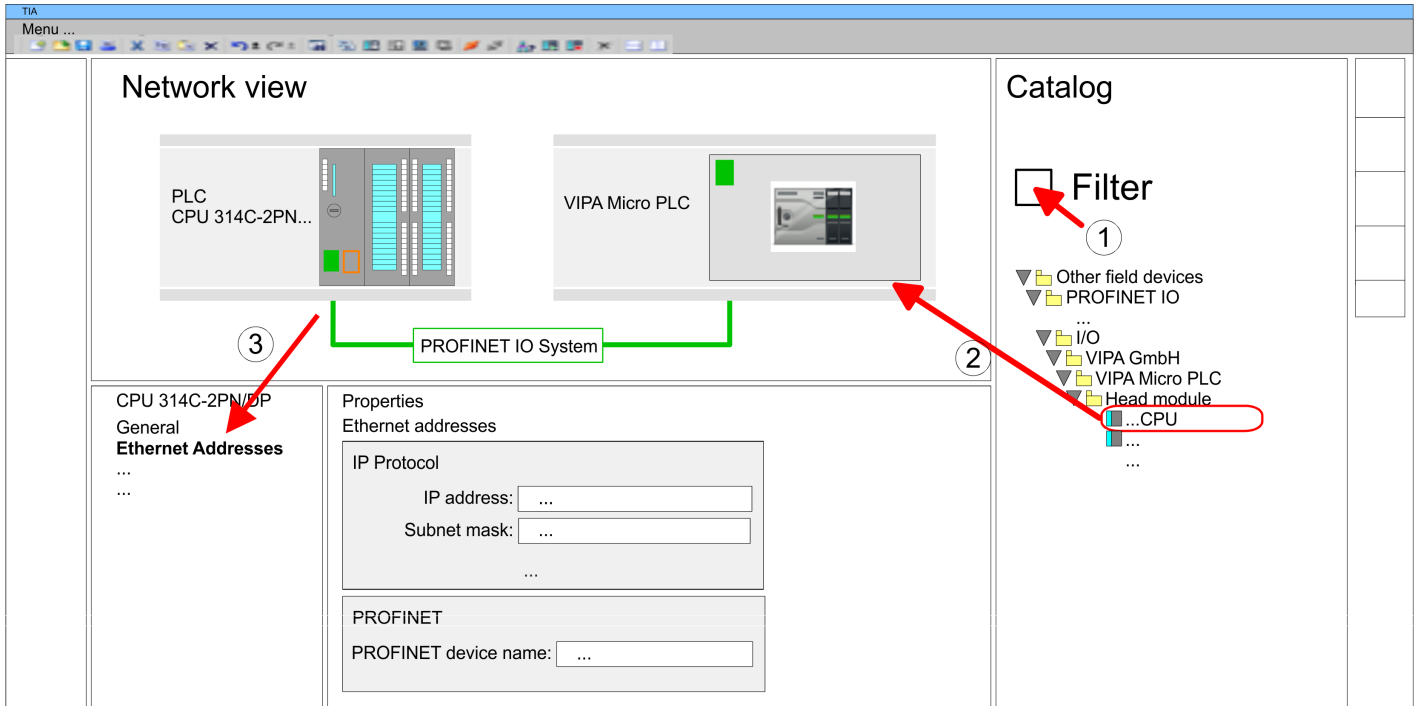

5. Select in the *Network view* the IO device 'VIPA MICRO PLC' and switch to the *Device overview*.
 ⇒ In the *Device overview* of the PROFINET IO device 'VIPA MICRO PLC' the CPU is already placed at slot 0.

Configuration of Ethernet PG/OP channel

1. As Ethernet PG/OP channel place at slot 4 the Siemens CP 343-1 (6GK7 343-1EX30 0XE0 V3.0).
2. Open the "Property" dialog by clicking on the CP 343-1EX30 and enter for the CP at "Properties" at "Ethernet address" the IP address data, which you have assigned before. You get valid IP address parameters from your system administrator.

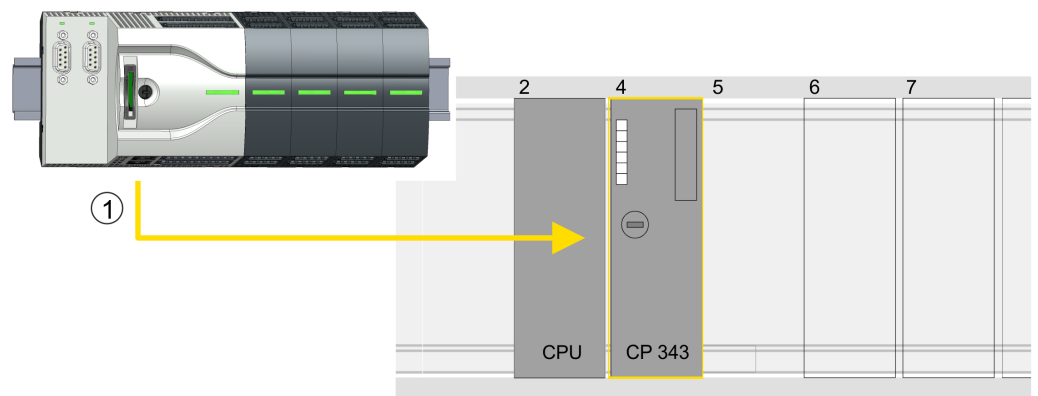

1 Ethernet PG/OP channel

Device overview

Module	...	Slot	...	Type	...
PLC ...		2		CPU 314C-2PN/DP	

MPI/DP interface	2 X1	MPI/DP interface
PROFINET interface	2 X2	PROFINET interface
...
CP 343-1	4	CP 343-1
...

Switch I/O periphery to PWM

For parametrization of the input/output periphery and the *technological functions* the corresponding sub modules of the Siemens CPU 314C-2 PN/DP (314-6EH04-0AB0 V3.3) is to be used. For PWM output, the sub module count must be switched to '*Pulse-width modulation*'. If you are using a channel other than channel 0, you must adapt it in the hardware configuration and in your user program.

1. Double-click the counter sub module of the CPU 314C-2 PN/DP.
⇒ The dialog '*Properties*' is opened.
2. For example, select '*channel 0*' and select the function '*Pulse-width modulation*' as '*Operating mode*'.
3. Leave all values unchanged.

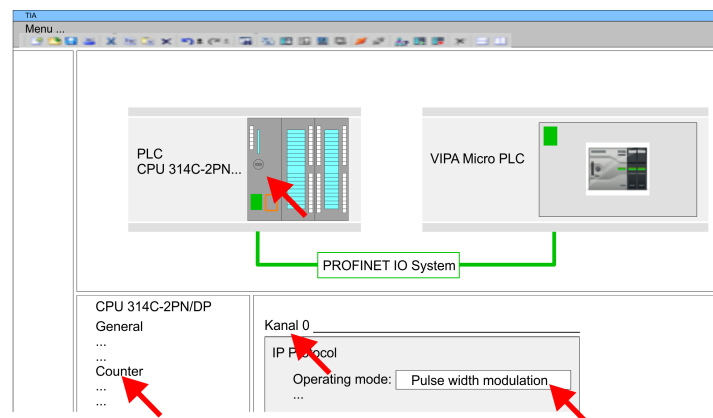

4. Click at the CPU and select '*Context menu* → *Compile* → *All*'.

13.4.6.3 User program

Include library

1. Go to the service area of www.vipa.com.
2. Download the *Simple Motion Control* library from the download area at '*VIPA Lib*'. The library is available as packed zip file for the corresponding TIA Portal version.
3. Start your un-zip application with a double click on the file ...TIA_Vxx.zip and copy all the files and folders in a work directory for the Siemens TIA Portal.
4. Switch to the *Project view* of the Siemens TIA Portal.
5. Choose "Libraries" from the task cards on the right side.
6. Click at "Global library".
7. Click on the free area inside the '*Global Library*' and select '*Context menu* → *Retrieve library*'.
8. Navigate to your work directory and load the file ...Simple Motion.zalxx.

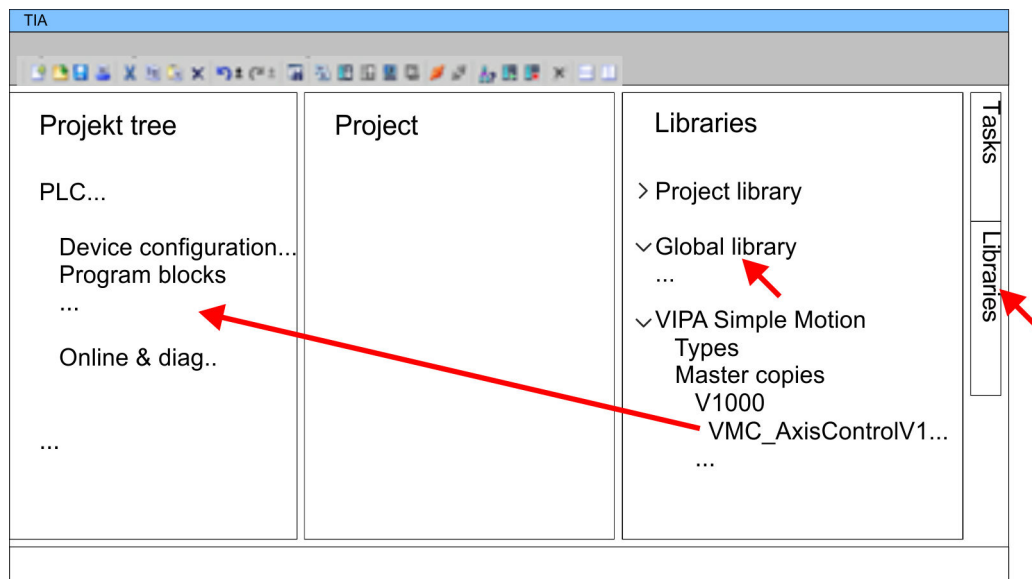
Copy blocks into project

➔ Copy the following block from the library into the "Program blocks" of the *Project tree* of your project.

- V1000 PWM
 - FB885 – VMC_AxisControlV1000PWM ↗ *Chap. 13.4.7.1 'FB 885 - VMC_AxisControlV1000_PWM - Axis control over PWM' page 449*

OB 1**Configuration of the axis**

If you are using a channel other than channel 0, you must adapt it in the hardware configuration and in your user program.

1. ➔ Open in the *Project tree* within the CPU at '*Programming blocks*' the OB 1 and program the Call FB 885, DB 885.
 - ⇒ The dialog '*Add instance data block*' opens.
2. ➔ Set the number for the instance data block, if not already done, and close the dialog with [OK].
 - ⇒ The block call is created and the parameters are listed

3. Assign the following parameters for the sample project:

```

⇒ CALL FB "VMC_AxisControlV1000PWM" ,
   "VMC_AxisCtrlV1000PWM_885"
      I_ChannelNumberPWM := "Ax1_I_ChannelNumberPWM"
      I_MA_Alarm          := "Ax1_MA_Alarm"
      I_P1_Ready         := "I_P1_Ready"
      MaxVelocityDrive   := 1.000000e+002
      AxisEnable         := "Ax1_AxisEnable"
      AxisReset          := "Ax1_AxisReset"
      StopExecute        := "Ax1_StopExecute"
      MvVelocityExecute  := "Ax1_MvVelExecute"
      JogPositive        := "Ax1_JogPositive"
      JogNegative        := "Ax1_JogNegative"
      Velocity           := "Ax1_Velocity"
      I_S1_ForwardRun    := "Ax1_S1_ForwardRun"
      I_S2_ReverseRun    := "Ax1_S2_ReverseRun"
      I_S4_AlarmReset    := "Ax1_S4_AlarmReset"
      MinUserVelocity    := "Ax1_MinUserVelocity"
      MaxUserVelocity    := "Ax1_MaxUserVelocity"
      AxisReady          := "Ax1_AxisReady"
      AxisEnabled        := "Ax1_AxisEnabled"
      AxisError          := "Ax1_AxisError"
      AxisErrorID        := "Ax1_AxisErrorID"
      DriveError         := "Ax1_DriveError"
      CmdActive          := "Ax1_CmdActive"
      CmdDone            := "Ax1_CmdDone"
      CmdBusy            := "Ax1_CmdBusy"
      CmdAborted         := "Ax1_CmdAborted"
      CmdError           := "Ax1_CmdError"
      CmdErrorID        := "Ax1_CmdErrorID"

```

The addresses of *I_P1_Ready* and *I_MA_Alarm* are derived from the addresses of the inputs which are connected to the digital outputs of the drive. These can be determined via the sub module '*-X25 DI/DIO*' of the CPU.

The addresses of *I_S1_ForwardRun*, *I_S2_ReverseRun* and *I_S4_AlarmReset* are obtained from the addresses of the outputs which are connected to the digital inputs of the drive. These can be determined via the sub module '*-X25 DI/DIO*' of the CPU.

Sequence of operations

- 1.** Select '*Edit → Compile*' and transfer the project into your CPU. You can find more information on the transfer of your project in the online help of the Siemens TIA Portal.
 - ⇒ You can take your application into operation now.

**CAUTION!**

Please always observe the safety instructions for your drive, especially during commissioning!

- 2.** Bring your CPU into RUN and turn on your drive.
 - ⇒ The FB 875 - VMC_AxisControl_PT is executed cyclically.
- 3.** As soon as *AxisReady* = TRUE, you can use *AxisEnable* to enable the drive.
- 4.** You now have the possibility to control your drive via its parameters and to check its status. ↪ *Chap. 13.4.7.1 'FB 885 - VMC_AxisControlV1000_PWM - Axis control over PWM' page 449*

13.4.7 Drive specific block

13.4.7.1 FB 885 - VMC_AxisControlV1000_PWM - Axis control over PWM

13.4.7.1.1 Description

With the FB *VMC_AxisControlV1000_PWM* you can control an inverter drive, which is connected via PWM and check its status.

Parameter

Parameter	Declaration	Data type	Description
I_Channel-NumberPWM	INPUT	INT	Channel number of the PWM output used to drive the PWM input of the inverter drive.
I_MA_Alarm	INPUT	BOOL	<ul style="list-style-type: none"> ■ Digital input for connecting the <i>I_MA_Alarm</i> signal (MA) <ul style="list-style-type: none"> – TRUE: The inverter drive has detected an error.
I_P1_Ready	INPUT	BOOL	<ul style="list-style-type: none"> ■ Digital input for connecting the <i>I_P1_Ready</i> signal <ul style="list-style-type: none"> – FALSE: The inverter drive is ready.
MaxVelocity-Drive	INPUT	REAL	<ul style="list-style-type: none"> ■ Maximum speed of the inverter drive [user units]. ↗ <i>Chap. 13.4.7.1.2 'Calculating' page 451</i>
AxisEnable	INPUT	BOOL	<ul style="list-style-type: none"> ■ Enable/disable axis <ul style="list-style-type: none"> – This parameter is used for block-internal release and has no influence on the inverter drive. – TRUE: The axis is enabled. – FALSE: The axis is disabled.
AxisReset	INPUT	BOOL	<ul style="list-style-type: none"> ■ Reset axis <ul style="list-style-type: none"> – Edge 0-1: Axis reset is performed. – The status of a reset, started with <i>AxisReset</i>, is not indicated at the outputs <i>CmdActive</i>, <i>CmdDone</i>, <i>CmdBusy</i>, <i>CmdAborted</i>, <i>CmdError</i> and <i>CmdErrorID</i>.
StopExecute	INPUT	BOOL	<ul style="list-style-type: none"> ■ Stop axis <ul style="list-style-type: none"> – Edge 0-1: Stopping of the axis is started. <p>Note: <i>StopExecute</i> = 1: No other command can be started!</p>
MvVelocityExecute	INPUT	BOOL	<ul style="list-style-type: none"> ■ Start moving the axis <ul style="list-style-type: none"> – Edge 0-1: The axis is accelerated/decelerated to the speed specified.
JogPositive	INPUT	BOOL	<p>Jog operation positive</p> <ul style="list-style-type: none"> ■ Drive axis with constant velocity in positive direction <ul style="list-style-type: none"> – Edge 0-1: Drive axis with constant velocity is started. – Edge 1-0: The axis is stopped.
JogNegative	INPUT	BOOL	<p>Jog operation negative</p> <ul style="list-style-type: none"> ■ Drive axis with constant velocity in negative direction <ul style="list-style-type: none"> – Edge 0-1: Drive axis with constant velocity is started. – Edge 1-0: The axis is stopped.
Velocity	INPUT	REAL	<p>Velocity setting (signed value) in [user units / s].</p> <p>Note: <i>JogPositive</i> and <i>JogNegative</i> use the absolute value of the speed.</p>
I_S1_ForwardRun	OUTPUT	BOOL	<ul style="list-style-type: none"> ■ Digital output for controlling the inverter drive signal S1 <ul style="list-style-type: none"> – TRUE: Enables the inverter drive in positive direction.

Usage inverter drive via PWM > Drive specific block

Parameter	Declaration	Data type	Description
I_S2_ReverseRun	OUTPUT	BOOL	<ul style="list-style-type: none"> ■ Digital output for controlling the inverter drive signal S2 – TRUE: Enables the inverter drive in negative direction.
I_S4_Alarm-Reset	OUTPUT	BOOL	<ul style="list-style-type: none"> ■ Digital output for controlling the inverter drive signal S4 – TRUE: Alarm messages are reset in the inverter drive. – FALSE: Alarm messages in the inverter drive remain.
MinUserVelocity	OUTPUT	REAL	Minimum speed (period duration = 65535µs = maximum period of the PWM output) of the inverter drive [user units].
MaxUserVelocity	OUTPUT	REAL	Maximum speed at a maximum frequency of 20kHz of the inverter drive [user units].
AxisReady	OUTPUT	BOOL	<ul style="list-style-type: none"> ■ AxisReady – TRUE: The axis is ready to switch on. – FALSE: The axis is not ready to switch on. → Check and fix <i>AxisError</i> (see <i>AxisErrorID</i>). → Check and fix <i>DriveError</i> (see <i>DriveErrorID</i>).
AxisEnabled	OUTPUT	BOOL	<ul style="list-style-type: none"> ■ Status axis – TRUE: Axis is switched on and accepts motion commands. – FALSE: Axis is not switched on and does not accept motion commands.
AxisError	OUTPUT	BOOL	<ul style="list-style-type: none"> ■ Error on axis – TRUE: An error has occurred. <p>Additional error information can be found in the parameter <i>AxisErrorID</i>.</p> <p>→ The axis is locked (<i>S_On</i> = FALSE and <i>AxisEnabled</i> = FALSE). Command is not executed.</p>
AxisErrorID	OUTPUT	WORD	<p>Additional error information</p> <p>↳ <i>Chap. 13.10 'ErrorID - Additional error information' page 637</i></p>
DriveError	OUTPUT	BOOL	<ul style="list-style-type: none"> ■ Error on the inverter drive – TRUE: An error has occurred. → The axis is disabled.
CmdActive	OUTPUT	BYTE	<ul style="list-style-type: none"> ■ Command – 0: no Cmd active – 1: STOP – 2: MvVelocity – 4: JogPos – 5: JogNeg
CmdDone	OUTPUT	BOOL	<ul style="list-style-type: none"> ■ Status Done – TRUE: Job ended without error.
CmdBusy	OUTPUT	BOOL	<ul style="list-style-type: none"> ■ Status Busy – TRUE: Job is running.
CmdAborted	OUTPUT	BOOL	<ul style="list-style-type: none"> ■ Status Aborted – TRUE: The job was aborted during processing by another job. <p>Note: <i>CmdAborted</i> is reset when a Cmd is started</p>

Parameter	Declaration	Data type	Description
CmdError	OUTPUT	BOOL	<ul style="list-style-type: none"> ■ Status Error <ul style="list-style-type: none"> – TRUE: An error has occurred. The axis is disabled Additional error information can be found in the parameter <i>CmdErrorID</i> .
CmdErrorID	OUTPUT	WORD	Additional error information ↪ <i>Chap. 13.10 'ErrorID - Additional error information' page 637</i>

13.4.7.1.2 Calculating

MaxVelocityDrive

$$n = 2 \cdot 60 \cdot \frac{f_{\max, \text{out}}}{\text{poles}} \frac{1}{\text{min}}$$

This value is used to normalize the input value *Velocity*.

$f_{\max, \text{out}}$ - Maximum frequency (parameter E1-04)

poles - Number of motor poles (parameter E5-04)

n - Maximum speed of the inverter drive [user units] such as 1000.0 % or 3000.0 rotations/min.

13.4.7.1.3 Functionality

Switch the axis on or off

- The *AxisEnable* input is used to switch an axis on or off.
- Switching on is only possible if *AxisReady* = TRUE, i.e. the axis is ready to switch on.
- As soon as the axis is switched on, this is indicated by the status information *AxisEnabled*.
- If the axis has an error, this is indicated by the status information *AxisError*. For more information refer to *AxisErrorID*.

Acknowledge axis error

- With *AxisReset* you can acknowledge axis errors.
- Errors are reported via *DriveError*.

Stop axis

- You can stop an axis in motion by setting *StopExecute*.
- As long as *StopExecute* is set, no further pulses are generated and all commands are blocked.

Velocity mode

- Precondition: The axis is switched on and *AxisReady* = TRUE.
- With *MvVelocityExecute*, you can bring the axis to rotate with constant velocity.
- You specify the velocity via *Velocity*.
- By setting 0, the axis stops as well as with *StopExecute*.
- The direction of rotation is determined by the sign of *Velocity*.
- The *Velocity* value can be 0 or $\text{MinUserVelocity} \leq \text{Velocity} \leq \text{MaxUserVelocity}$.

Jog mode

- Precondition: The axis is switched on and *AxisReady* = TRUE.
- With an edge 0-1 at *JogPositive* or *JogNegative*, you can control your drive in jog mode. In this case, a jogging command is executed in the corresponding direction of rotation.
- You specify the velocity via *Velocity*. The sign is not relevant.
- With an edge 1-0 at *JogPositive* or *JogNegative* respectively by setting *StopExecute* the axis is stopped.

Usage inverter drive via Modbus RTU > Set the parameters on the inverter drive

13.5 Usage inverter drive via Modbus RTU

13.5.1 Overview

Precondition

- SPEED7 Studio from V1.7.1
or
- Siemens SIMATIC Manager from V 5.5, SP2 & *Simple Motion Control Library*
or
- Siemens TIA Portal V 14 & *Simple Motion Control Library*
- System MICRO or System SLIO CPU with serial interface such as CPU M13-CCF0000 or CPU 013-CCF0R00.
- V1000 inverter drive with serial interface and associated motor

Steps of configuration

1. ➤ Set the parameters on the inverter drive
 - The setting of the parameters happens by means of the software tool *Drive Wizard+*.
2. ➤ Hardware configuration in the VIPA *SPEED7 Studio*, Siemens SIMATIC Manager or Siemens TIA Portal.
 - Configuring the CPU.
3. ➤ Programming in the VIPA *SPEED7 Studio*, Siemens SIMATIC Manager or Siemens TIA Portal.
 - Connect the block for serial communication.
 - Connect the block for each Modbus slave.
 - Connect the block for the communication data of all Modbus slaves.
 - Connect the block for the communication manager.
 - Connect the block for initializing the inverter drive.
 - Connecting the blocks for motion sequences.

13.5.2 Set the parameters on the inverter drive



CAUTION!

Before the commissioning, you have to adapt your inverter drive to your application with the *Drive Wizard+* software tool! More may be found in the manual of your inverter drive.

The following table shows all parameters which do not correspond to the default values. The following parameters must be set via *Drive Wizard+* to match the *Simple Motion Control Library*.

No.	Designation	Range of values	Setting for <i>Simple Motion Control Library</i>
H5-01	Slave address inverter drive	00h, 20h	By default, the slave address is set to 1Fh. Please note that addresses in the network must not be assigned more than once!
H5-02	Communication speed MEMOBUS/Modbus	0, 1, 2, ..., 8	■ 3: 9600bit/s
H5-03	Transmission parity MEMOBUS/Modbus	0, 1, 2	■ 0: no parity

Usage inverter drive via Modbus RTU > Set the parameters on the inverter drive

No.	Designation	Range of values	Setting for <i>Simple Motion Control Library</i>
H5-04	Stop method after communication error (CE error)	0, 1, 2, 3	■ 3: Operation continues with alarm
H5-05	Stop method after communication error (CE error)	0, 1	■ 1: Activated - If the connection is aborted for longer than 2s (adjustable via <i>H2-09</i>), a CE error is triggered.
H5-06	Waiting time between receiving and sending data from the inverter drive	5 ... 65ms	■ 5ms
H5-07	Request to send (RTS) control	0, 1	■ 1: Activated - RTS is activated only when sending (RS485 or RS422 and <i>multi-drop</i>)
H5-09	Time after which a communication error (CE error) is detected.	0,0 ... 10,0s	■ 2s
H5-10	Step size (resolution) for the MEMOBUS/Modbus register 0025h	0, 1	By default, the resolution is set to 0.1V increments (0). ■ 0: 0.1V increments ■ 1: 1V increments
H5-11	ENTER function for connections	0, 1	■ 1: Enter command not required
H5-12	Selection start command method	0, 1	■ 1: Run/Stop
B1-01	Input source frequency setpoint 1	0, 1, 2, 3, 4	■ 2: MEMOBUS/Modbus communication
B1-02	Input source start command 1	0, 1, 2, 3	■ 2: MEMOBUS/Modbus communication
B1-15	Input source frequency setpoint 2	0, 1, 2, 3, 4	■ 2: MEMOBUS/Modbus communication
B1-16	Input source start command 2	0, 1, 2, 3	■ 2: MEMOBUS/Modbus communication



For all settings to be accepted, you must restart the inverter drive after parametrization!

13.5.3 Wiring

RS485 cabling

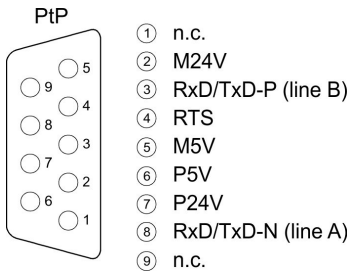

The following figure shows the connection of V1000 inverter drives via RS485. Here the individual inverter drives are connected via PROFIBUS cables and connected to the CPU via a PROFIBUS connector to the PtP interface (Point-to-Point).

- A maximum of 8 inverter drives can be connected via Modbus RTU.
- For all connected inverter drives, parameter H5-07 must be set to 1.
- The serial line must be terminated at its end with a terminator. To activate it, you must set switch S2 to 'ON' on the corresponding inverter drive.

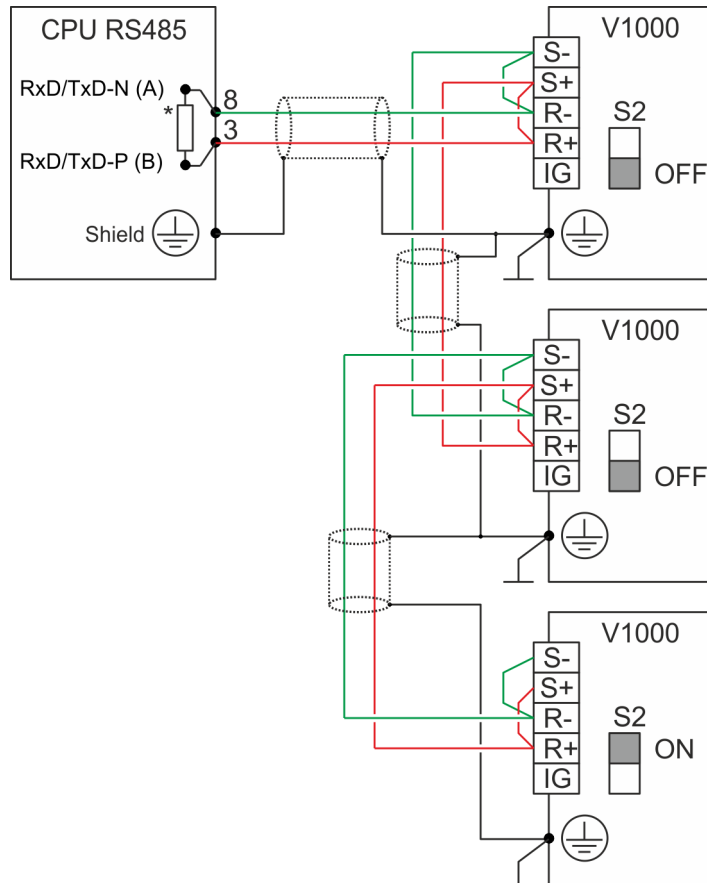

- *) For a trouble-free data traffic, use a terminating resistor of approx. 120Ω at the CPU, such as the PROFIBUS connector from VIPA.
- Never connect the cable shield and the M5V (pin 5) together, due to the compensation currents the interfaces could be destroyed!

Connection of the CPU

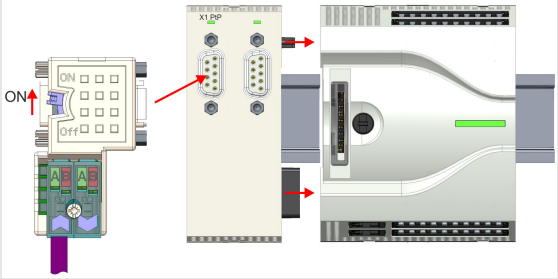
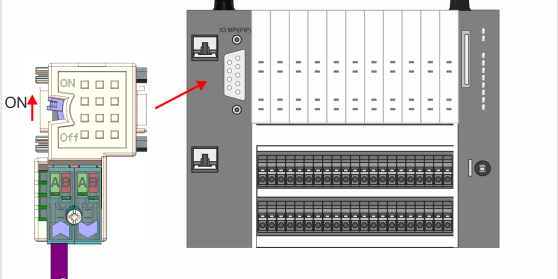
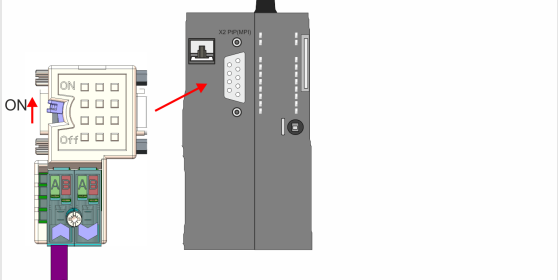
CPU	Connection	Comment
<p>MICRO CPU M13C</p>		<ul style="list-style-type: none"> ■ PtP communication requires the optional EM M09 extension module. ■ The extension module provides interface X1: PtP (RS422/485) with fixed pin assignment. ■ For connection to the CPU, use a PROFIBUS connector from VIPA. ■ Activate the terminating resistor on the PROFIBUS connector. ■ After switching on the power supply and a short start-up time, the CPU is ready for the PtP communication.
<p>System SLIO CPU 013C</p>		<ul style="list-style-type: none"> ■ The CPU has the interface X3 MPI(PtP) with a fix pinout. ■ For connection to the CPU, use a PROFIBUS connector from VIPA. ■ Activate the terminating resistor on the PROFIBUS connector. ■ After switching on the power supply and a short start-up time or after an overall reset, the interface has MPI functionality. You can activate the PtP functionality via the hardware configuration. <p>↳ Chap. 13.5.4 'Usage in VIPA SPEED7 Studio' page 457</p> <p>↳ Chap. 13.5.5 'Usage in Siemens SIMATIC Manager' page 471</p> <p>↳ Chap. 13.5.6 'Usage in Siemens TIA Portal' page 486</p>
<p>System SLIO CPU 014 ... 017</p>		<ul style="list-style-type: none"> ■ The CPU has the interface X2 PtP(MPI) which is per default set to PtP communication (point to point). ■ For connection to the CPU, use a PROFIBUS connector from VIPA. ■ Activate the terminating resistor on the PROFIBUS connector. ■ After switching on the power supply and a short start-up time, the CPU is ready for the PtP communication.

Connection of the YASKAWA inverter drives

FU	Connection continuous	Connection termination
J1000		
V1000		
A1000		
GA700		



More can be found in the according manual.

13.5.4 Usage in VIPA *SPEED7 Studio*

13.5.4.1 Hardware configuration

13.5.4.1.1 Hardware configuration System MICRO

Add CPU in the project

Please use the *SPEED7 Studio* V1.7.1 and up for the configuration.

1. Start the *SPEED7 Studio*.

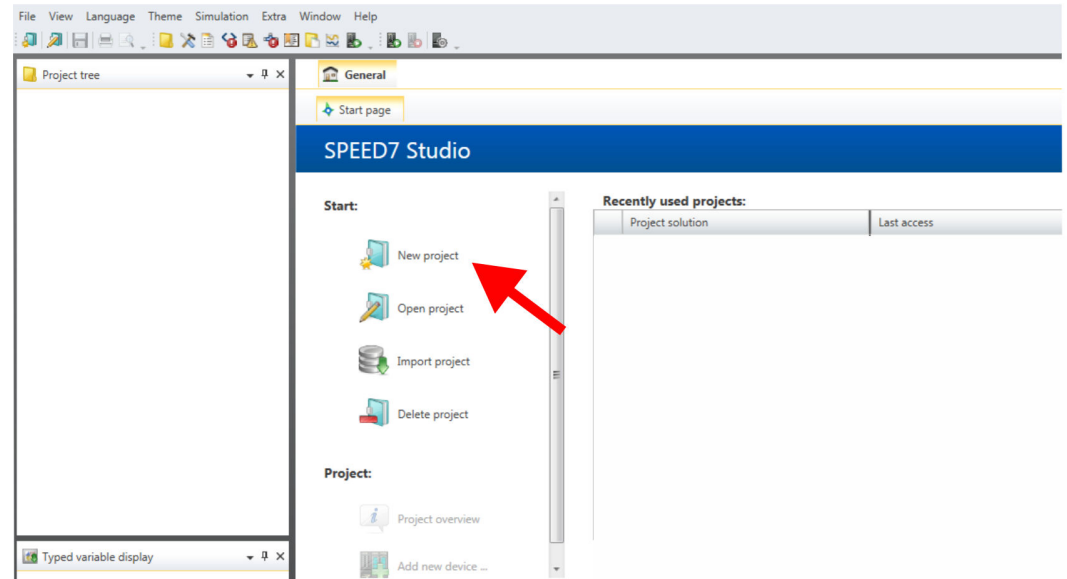

2. Create a new project at the start page with 'New project' and assign a 'Project name'.

⇒ A new project is created and the view 'Devices and networking' is shown.

3. Click in the *Project tree* at 'Add new device ...'.

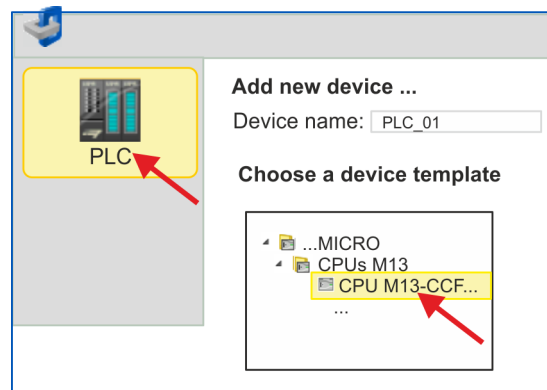
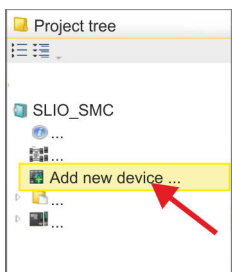

⇒ A dialog for device selection opens.

4. Select from the 'Device templates' your System MICRO CPU M13-CCF0000 and click at [OK].

⇒ The CPU is inserted in 'Devices and networking' and the 'Device configuration' is opened.

Configuration of Ethernet PG/OP channel

1. Click in the *Project tree* at *'Devices and networking'*.
 ⇒ You will get a graphical object view of your CPU.

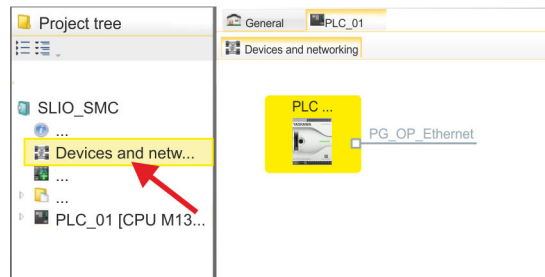

2. Click at the network *'PG_OP_Ethernet'*.
3. Select *'Context menu → Interface properties'*.
 ⇒ A dialog window opens. Here you can enter the IP address data for your Ethernet PG/OP channel. You get valid IP address parameters from your system administrator.
4. Confirm with [OK].
 ⇒ The IP address data are stored in your project listed in *'Devices and networking'* at *'Local components'*.
 After transferring your project your CPU can be accessed via Ethernet PG/OP channel with the set IP address data.

Enable PtP functionality

1. Click in the *Project tree* at *'PLC..CPU M13... → Device configuration'*.
 ⇒ The *'Device configuration'* opens.

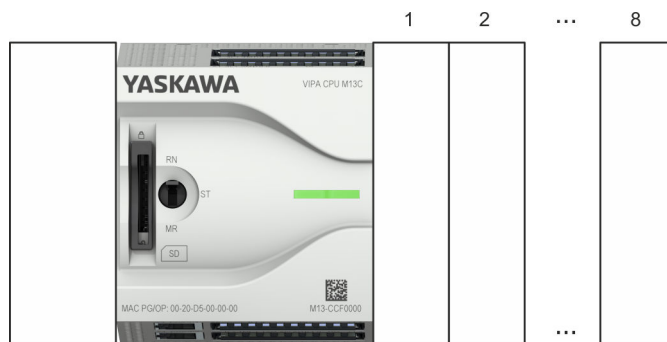

2. In the *'Catalog'* at *'Components'*, open the *'Serial'* collection and drag and drop the serial module *'M09-OCB00 - Serial2x'* to the left slot of the CPU. By default, the interface X1 is set to PtP functionality.

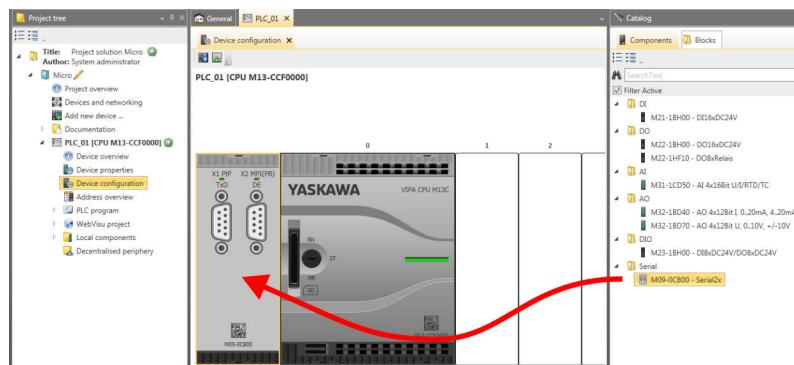

13.5.4.1.2 Hardware configuration System SLIO CPU 013C

Add CPU in the project

Please use the *SPEED7 Studio* V1.7.1 and up for the configuration.

1. Start the *SPEED7 Studio*.

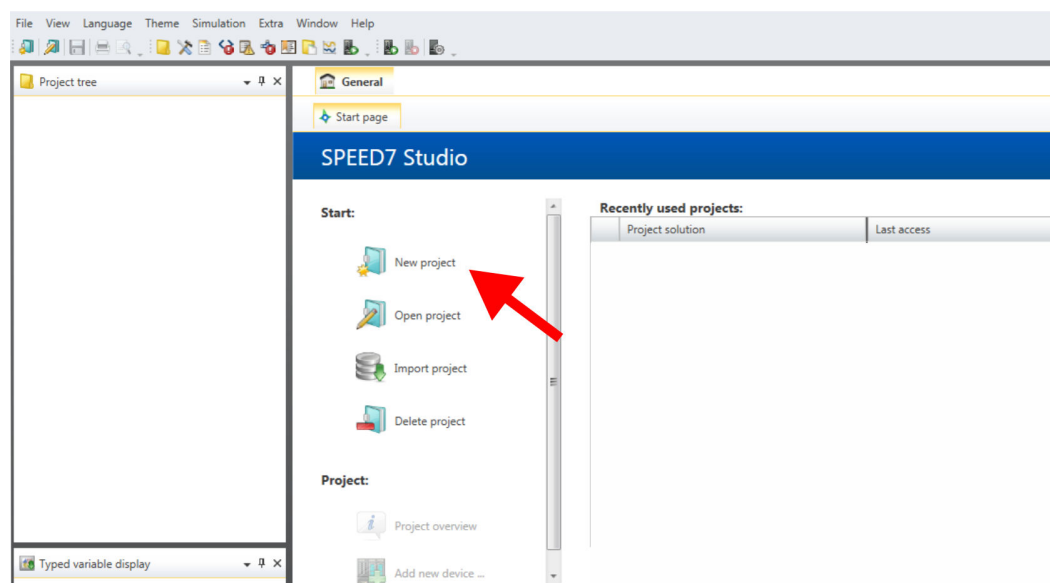

2. Create a new project at the start page with 'New project' and assign a 'Project name'.

⇒ A new project is created and the view 'Devices and networking' is shown.

3. Click in the *Project tree* at 'Add new device ...'.

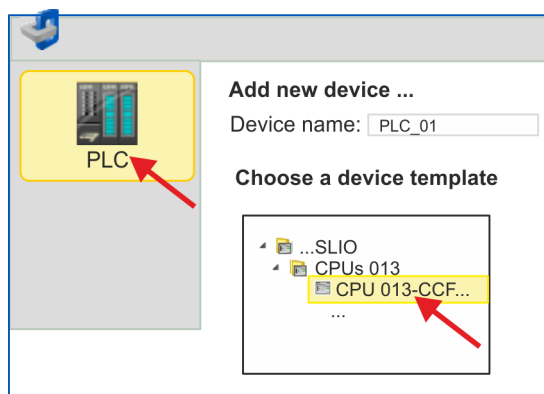
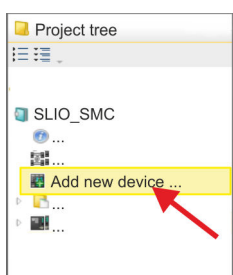

⇒ A dialog for device selection opens.

4. Select from the 'Device templates' your System SLIO CPU 013-CCF0R00 and click at [OK].

⇒ The CPU is inserted in 'Devices and networking' and the 'Device configuration' is opened.

Configuration of Ethernet PG/OP channel

1. Click in the *Project tree* at *'Devices and networking'*.
 ⇒ You will get a graphical object view of your CPU.

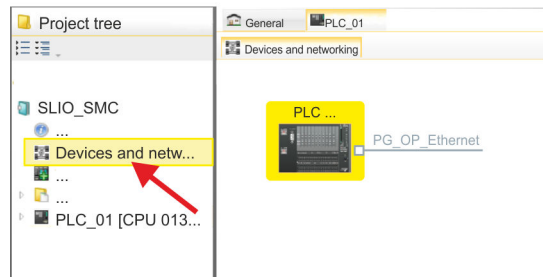

2. Click at the network *'PG_OP_Ethernet'*.
3. Select *'Context menu → Interface properties'*.
 ⇒ A dialog window opens. Here you can enter the IP address data for your Ethernet PG/OP channel. You get valid IP address parameters from your system administrator.
4. Confirm with [OK].
 ⇒ The IP address data are stored in your project listed in *'Devices and networking'* at *'Local components'*.
 After transferring your project your CPU can be accessed via Ethernet PG/OP channel with the set IP address data.

Enable PtP functionality

1. Click in the *Project tree* at *'PLC... > Device configuration'*.
2. Click in the *'Device configuration'* at *'0 CPU 013...'* and select *'Context menu → Components properties'*.
 ⇒ The properties dialog is opened.

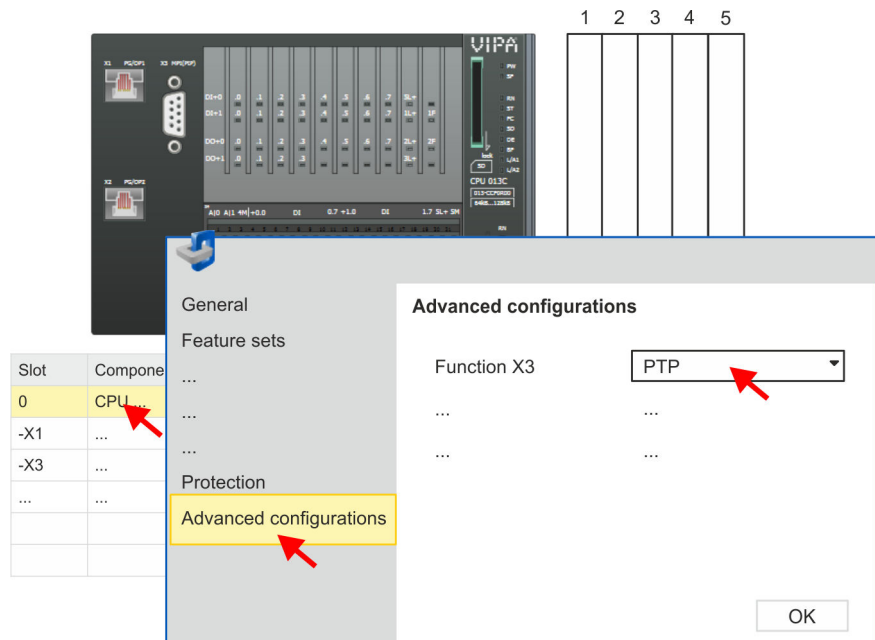

3. Click at *'Advanced configurations'* and select at *'Function X3'* the value *'PTP'*.

13.5.4.1.3 Hardware configuration System SLIO CPU 014 ... 017

Add CPU in the project

Please use the *SPEED7 Studio* V1.7.1 and up for the configuration.

1. Start the *SPEED7 Studio*.

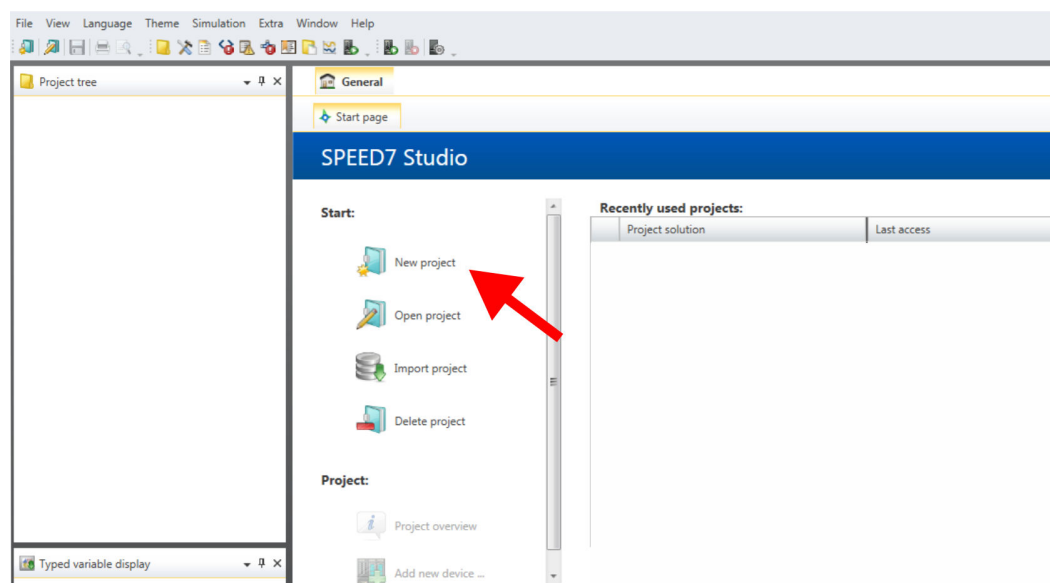

2. Create a new project at the start page with 'New project' and assign a 'Project name'.

⇒ A new project is created and the view 'Devices and networking' is shown.

3. Click in the *Project tree* at 'Add new device ...'.

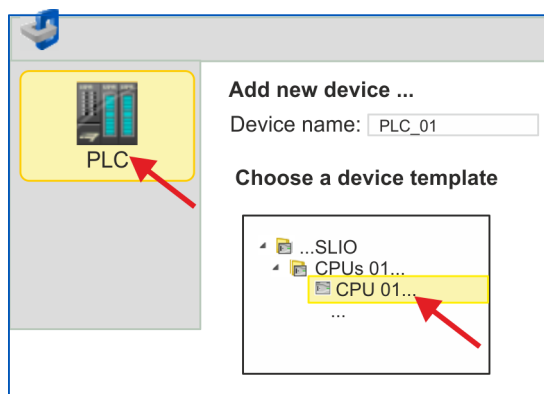
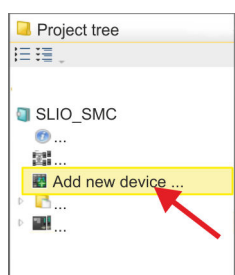

⇒ A dialog for device selection opens.

4. Select from the 'Device templates' the corresponding System SLIO CPU and click at [OK].

⇒ The CPU is inserted in 'Devices and networking' and the 'Device configuration' is opened.

Configuration of Ethernet PG/OP channel

1. Click in the *Project tree* at *'Devices and networking'*.
 ⇒ You will get a graphical object view of your CPU.

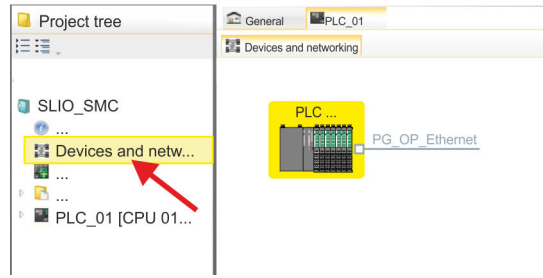

2. Click at the network *'PG_OP_Ethernet'*.
3. Select *'Context menu → Interface properties'*.
 ⇒ A dialog window opens. Here you can enter the IP address data for your Ethernet PG/OP channel. You get valid IP address parameters from your system administrator.
4. Confirm with [OK].
 ⇒ The IP address data are stored in your project listed in *'Devices and networking'* at *'Local components'*.

After transferring your project your CPU can be accessed via Ethernet PG/OP channel with the set IP address data.

Enable PtP functionality

For the System SLIO CPUs 014 ... 017, the RS485 interface is set to PtP communication as standard. A hardware configuration to enable the PtP functionality is not necessary.

13.5.4.2 User program

13.5.4.2.1 Program structure

OB 100

FB 876 - VMC_ConfigMaster_RTU
SFC 216 - SER_CFG

- FB 876 - VMC_ConfigMaster_RTU ↻ 504
 - This block is used to parametrize the serial interface of the CPU for Modbus RTU communication.
 - Internally block SFC 216 - SER_CFG is called.

OB 1

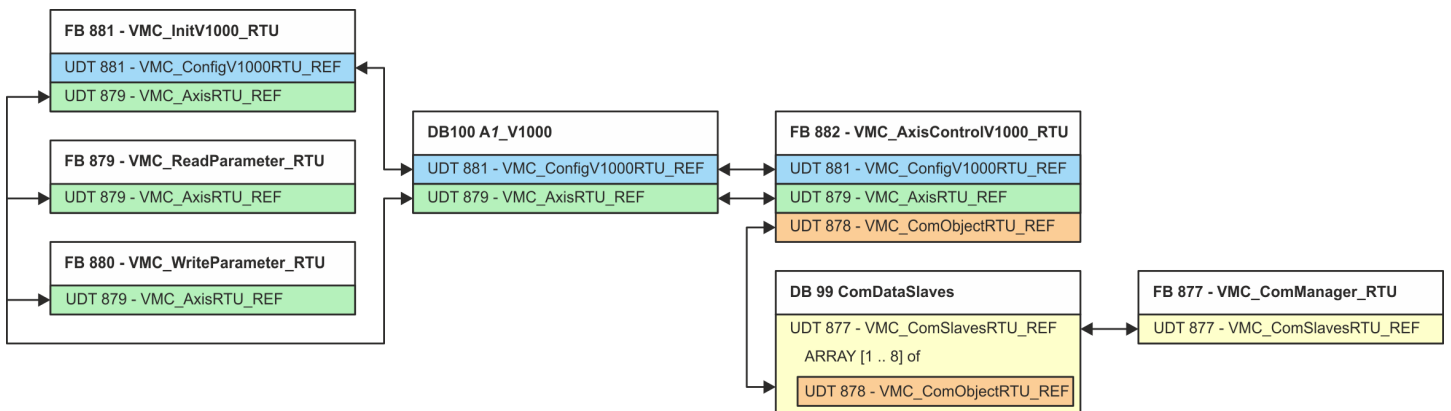

With the exception of blocks DB 99 and FB 877, you must create the blocks listed below for each connected inverter drive:

- FB 881 - VMC_InitV1000_RTU ↗ 507
 - The FB 881 - VMC_InitV1000_RTU initializes the corresponding inverter drive with the user data.
 - Before an inverter drive can be controlled, it must be initialized.
 - UDT 881 - VMC_ConfigV1000RTU_REF ↗ 504
 - UDT 879 - VMC_AxisRTU_REF ↗ 504
- FB 879 - VMC_ReadParameter_RTU ↗ 506
 - With this FB you have read access to the parameters of an inverter drive, which is connected serially via Modbus RTU.
 - The read data are recorded in a data block.
 - UDT 879 - VMC_AxisRTU_REF ↗ 504
- FB 880 - VMC_WriteParameter_RTU ↗ 507
 - With this FB you have read access to the parameters of an inverter drive, which is connected serially via Modbus RTU.
 - The data to be written must be stored in a data block.
 - UDT 879 - VMC_AxisRTU_REF ↗ 504
- DB 100 - A1_V1000
 - For each inverter drive, which is serially connected via Modbus RTU, a data block must be created.
 - UDT 879 - VMC_AxisRTU_REF ↗ 504
 - UDT 881 - VMC_ConfigV1000RTU_REF ↗ 504
- FB 882 - VMC_AxisControlV1000_RTU ↗ 509
 - With this block, you can control an inverter drive, which is serially connected via Modbus RTU and check its status.
 - UDT 881 - VMC_ConfigV1000RTU_REF ↗ 504
 - UDT 879 - VMC_AxisRTU_REF ↗ 504
 - UDT 878 - VMC_ComObjectRTU_REF ↗ 504
- DB 99 - ComDataSlaves
 - For the communication data of all the inverter drives (max. 8), which are serially connected via Modbus RTU, a common data block is to be created.
 - UDT 877 - VMC_ComSlavesRTU_REF ↗ 504
 - UDT 878 - VMC_ComObjectRTU_REF ↗ 504
- FB 877 - VMC_ComManager_RTU ↗ 505
 - The device ensures that only 1 inverter drive (Modbus slave) can use the serial interface. If several inverter drives are used, this block, as communication manager, sends the jobs to the respective Modbus slaves and evaluates their responses.
 - UDT 877 - VMC_ComSlavesRTU_REF ↗ 504

Usage inverter drive via Modbus RTU > Usage in VIPA SPEED7 Studio

13.5.4.2.2 Copy blocks into project

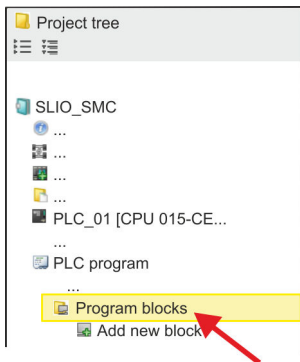

1. Click at 'Project tree → ...CPU... → PLC program → Program blocks'.

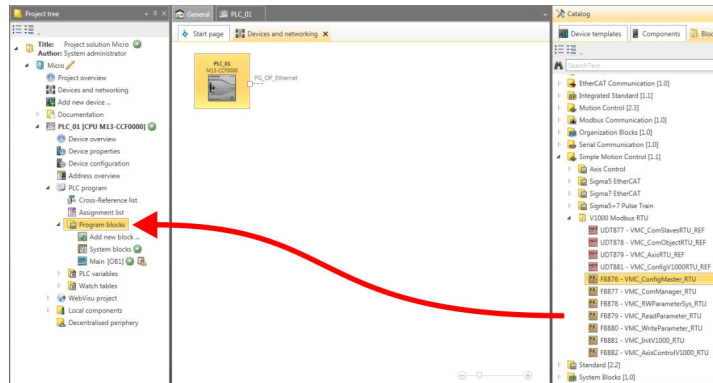

2. In the 'Catalog' at 'Blocks → Simple Motion Control' open the collection 'V1000 Modbus RTU' and drag and drop the following blocks into 'Program blocks' of the Project tree:

- FB 876 - VMC_ConfigMaster_RTU
- FB 877 - VMC_ComManager_RTU
- FB 878 - VMC_RWPParameterSys_RTU
- FB 879 - VMC_ReadParameter_RTU
- FB 880 - VMC_WriteParameter_RTU
- FB 881 - VMC_InitV1000_RTU
- FB 882 - VMC_AxisControlV1000_RTU

Here the following blocks are automatically added to the project:

- SEND (FB 60)
- RECEIVE (FB 61)
- RTU MB_MASTER (FB 72)
- SER_CFG (FC 216)
- SER_SND (FC 217)
- SER_RCV (FC 218)
- VMC_ComSlavesRTU_REF (UDT 877)
- VMC_ComObjectRTU_REF (UDT 878)
- VMC_AxisRTU_REF (UDT 879)
- VMC_ConfigV1000RTU_REF (UDT 881)

13.5.4.2.3 Create OB 100 for serial communication

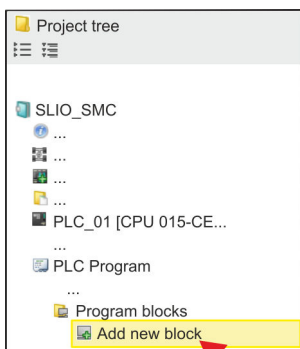

1. Click at 'Project tree → ...CPU... → PLC program → Program blocks → Add new block'.

⇒ The dialog 'Add block' is opened.

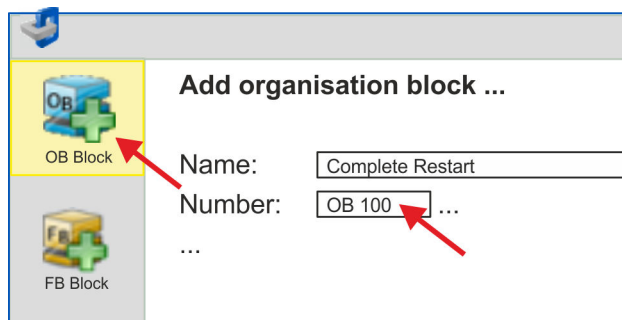

2. Enter OB 100 and confirm with [OK].
⇒ OB 100 is created and opened.
3. Add a Call FB876, DB876 to the OB 100.
⇒ The block call is created and a dialog opens to specify the instance data block 'VMC_ConfigMaster_RTU_876'.
4. Confirm the query of the instance data block with [OK].
5. Specify the following parameters:

Call FB876, DB876 ↪ *Chap. 13.5.7.5 'FB 876 - VMC_ConfigMaster_RTU - Modbus RTU CPU interface' page 504*

Baudrate	:= B#16#09	// Baud rate: 09h (9600bit/s)	IN: BYTE
CharLen	:= B#16#03	// Number data bits: 03h (8bit)	IN: BYTE
Parity	:= B#16#00	// Parity: 0 (none)	IN: BYTE
StopBits	:= B#16#01	// Stop bits: 1 (1bit)	IN: BYTE
TimeOut	:= W#16#1FFF	// Error wait time: 1FFFh (high selected)	IN: WORD
Valid	:= "ModbusConfigValid"	// Configuration	OUT BOOL
Error	:= "ModbusConfigError"	// Error feedback	OUT BOOL
ErrorID	:= "ModbusConfigErrorID"	// Additional error information	OUT: WORD

Symbolic variable

You create the symbolic variables via 'Context menu → Create / edit symbol'. Here you can assign the corresponding operands via a dialog.

13.5.4.2.4 Create data block for Modbus slave

For each inverter drive, which is serially connected via Modbus RTU, a data block must be created.

1. For this click at 'Project tree → ...CPU... → PLC program → Program blocks → Add new block'.
⇒ The dialog 'Add block' is opened.
2. Select the block type 'DB block' and assign it the name "A1_V1000". The DB number can freely be selected such as DB 100. Specify DB 100 and create this as a global DB with [OK].
⇒ The block is created and opened.
3. In "A1_V1000" create the following variables:
 - 'AxisData' from Type UDT 879 - VMC_AxisRTU_REF
 - 'V1000Data' from Type UDT 881 - VMC_ConfigV1000RTU_REF

13.5.4.2.5 Create data block for all Modbus slaves

For the communication data of the inverter drives, which are serially connected via Modbus RTU, a common data block is to be created.

1. ➤ For this click at 'Project tree → ...CPU... → PLC program → Program blocks → Add new block'.
 - ⇒ The dialog 'Add block' is opened.
2. ➤ Select the block type 'DB block' and assign it the name "ComDataSlaves". The DB number can freely be selected such as DB 99. Specify DB 99 and create this as a global DB with [OK].
 - ⇒ The block is created and opened.
3. ➤ In "ComDataSlaves" create the following variable:
 - 'Slaves' of Type UDT 877 - VMC_ComSlavesRTU_REF

13.5.4.2.6 OB 1 - Create instance of communication manager

The FB 877 - VMC_ComManager_RTU ensures that only 1 inverter drive (Modbus slave) can use the serial interface. As a communication manager, the block sends the jobs to the respective Modbus slaves and evaluates their responses.

1. ➤ Double-click at 'Project tree → ...CPU... → PLC program → Program blocks → Main [OB1]'.
 - ⇒ The programming window for OB 1 is opened.
2. ➤ Add a call Call FB877, DB877 to OB 1.
 - ⇒ The block call is created and a dialog opens to specify the instance data block 'VMC_ComManager_RTU_877'.
3. ➤ Confirm the query of the instance data block with [OK].
4. ➤ Specify the following parameters:

Call FB877, DB877 ↪ Chap. 13.5.7.6 'FB 877 - VMC_ComManager_RTU - Modbus RTU communication manager' page 505

NumberOfSlaves	:= 1	// Number of connected inverter drives: 1	IN: INT
WaitCycles	:= "ComWaitCycles"	// Minimum number of waiting cycles	IN: DINT
SlavesComData	:= "ComDataSlaves.Slave"	// Reference to all communication objects	IN-OUT: UDT 877

13.5.4.2.7 OB 1 - Create instance of the V1000 initialization

The FB 881 - VMC_InitV1000_RTU initializes the corresponding inverter drive with the user data. Before an inverter drive can be controlled, it must be initialized.

1. ➤ Add a Call FB881, DB881 to OB 1.
 - ⇒ The block call is created and a dialog opens to specify the instance data block 'VMC_InitV1000_RTU_881'.
2. ➤ Confirm the query of the instance data block with [OK].
3. ➤ Specify the following parameters:

Call FB881, DB881 ↪ Chap. 13.5.7.10 'FB 881 - VMC_InitV1000_RTU - Modbus RTU initialization' page 507

Execute	:= "A1_InitExecute"	// The job is started with edge 0-1.	IN: BOOL
---------	---------------------	--------------------------------------	----------

Usage inverter drive via Modbus RTU > Usage in VIPA SPEED7 Studio

Hardware	:= "A1_InitHardware"	// Specification of the hardware, used // 1: System SLIO CP040, 2: SPEED7 CPU	IN: BYTE
Laddr	:= "A1_InitLaddr"	// Logical address when using CP040	IN: INT
UnitId	:= "A1_InitUnitId"	// Modbus address of the V1000	IN: BYTE
UserUnitsVelocity	:= "A1_InitUserUnitsVel"	// User unit for velocities: // 0: Hz, 1: %, 2: RPM	IN: INT
UserUnitsAcceleration	:= "A1_InitUserUnitsAcc"	// User units acceleration/deceleration // 0: 0.01s, 1: 0.1s	IN: INT
MaxVelocityApp	:= "A1_InitMaxVelocityApp"	// Max. velocity in user units	IN: REAL
Done	:= "A1_InitDone"	// Status job finished	OUT: BOOL
Busy	:= "A1_InitBusy"	// Status job in progress	OUT: BOOL
Error	:= "A1_InitError"	// Error feedback	OUT: BOOL
ErrorID	:= "A1_InitErrorID"	// Additional error information	OUT: WORD
Axis	:= "A1_V1000".AxisData	// Reference to the general axis data	IN-OUT: UDT 879
V1000	:= "A1_V1000".V1000Data	// Reference to the drive-specific data	IN-OUT: UDT 881

Input values

All parameters must be interconnected with the corresponding variables or operands. The following input parameters must be pre-assigned:

- Hardware
 - Here specify the hardware you use to control your inverter drives:
 - 1: System SLIO CP040 whose logical address is to be specified via *Laddr*.
 - 2: SPEED7 CPU
- Laddr
 - Logical address for the System SLIO CP040 (*Hardware* = 1). Otherwise, this parameter is ignored.
- UnitId
 - Modbus address of the V1000.
- UserUnitsVelocity
 - User unit for speeds:
 - 0: Hz
 - Specified in hertz
 - 1: %
 - Specified as a percentage of the maximum speed
 - $= 2 \cdot f_{\max} / P$
 - with f_{\max} : max. output frequency (parameter E1-04)
 - p: Number of motor poles (motor-dependent parameter E2-04, E4-04 or E5-04)
 - 2: RPM
 - Data in revolutions per minute
- UserUnitsAcceleration
 - User units for acceleration and deceleration
 - 0: 0.01s (range of values: 0.00s - 600.00s)
 - 1: 0.1s (range of values: 0.0 - 6000.0s)
- MaxVelocityApp
 - Max. speed for the application. The specification must be made in user units and is used for synchronization in movement commands.

13.5.4.2.8 OB 1 - Create instance axis control V1000

With the FB 882 - VMC_AxisControlV1000_RTU you can control an inverter drive, which is serially connected via Modbus RTU and check its status.

1. ➤ Add a Call FB882, DB882 to OB 1.

⇒ The block call is created and a dialog opens to specify the instance data block 'VMC_AxisControlV1000_RTU_882'.

2. ➤ Confirm the query of the instance data block with [OK].

3. ➤ Specify the following parameters:

Call FB882, DB882 ↪ *Chap. 13.5.7.11 'FB 882 - VMC_AxisControlV1000_RTU - Modbus RTU Axis control' page 509*

AxisEnable	:= "A1_AxisEnable"	// Activation of the axis	IN: BOOL
AxisReset	:= "A1_AxisReset"	// Command: Reset error of the V1000.	IN: BOOL
StopExecute	:= "A1_StopExecute"	// Command: Stop - Stop axis	IN: BOOL
MvVelocityExecute	:= "A1_MvVelocityExecute"	// Command: MoveVelocity (velocity control)	IN: BOOL
Velocity	:= "A1_Velocity"	// Parameter: Velocity setting for MoveVelocity	IN: REAL
AccelerationTime	:= "A1_AccelerationTime"	// Parameter: Acceleration time	IN: REAL
DecelerationTime	:= "A1_DecelerationTime"	// Parameter: Deceleration time	IN: REAL
JogPositive	:= "A1_JogPositive"	// Command: JogPos	IN: BOOL
JogNegative	:= "A1_JogNegative"	// Command: JogNeg	IN: BOOL
JogVelocity	:= "A1_JogVelocity"	// Parameter: Velocity setting for jogging	IN: REAL
JogAccelerationTime	:= "A1_JogAccelerationTime"	// Parameter: Acceleration time for jogging	IN: REAL
JogDecelerationTime	:= "A1_JogDecelerationTime"	// Parameter: Deceleration time for jogging	IN: REAL
AxisReady	:= "A1_AxisReady"	// Status: Axis ready	OUT: BOOL
AxisEnabled	:= "A1_AxisEnabled"	// Status: Activation of the axis	OUT: BOOL
AxisError	:= "A1_AxisError"	// Status: Axis error	OUT: BOOL
AxisErrorID	:= "A1_AxisErrorID"	// Status: Additional error information for AxisError	OUT: WORD
DriveError	:= "A1_DriveError"	// Status: Error on the inverter drive	OUT: BOOL
ActualVelocity	:= "A1_ActualVelocity"	// Status: Current velocity	OUT: REAL
InVelocity	:= "A1_InVelocity"	// Status target velocity	OUT: BOOL
CmdDone	:= "A1_CmdDone"	// Status: Command finished	OUT: BOOL
CmdBusy	:= "A1_CmdBusy"	// Status: Command in progress	OUT: BOOL
CmdAborted	:= "A1_CmdAborted"	// Status: Command aborted	OUT: BOOL
CmdError	:= "A1_CmdError"	// Status: Command error	OUT: BOOL
CmdErrorID	:= "A1_CmdErrorID"	// Status: Additional error information for CmdError	OUT: WORD
CmdActive	:= "A1_CmdActive"	// Status: Active command	OUT: INT
DirectionPositive	:= "A1_DirectionPositive"	// Status: Direction of rotation positive	OUT: BOOL
DirectionNegative	:= "A1_DirectionNegative"	// Status: Direction of rotation negative	OUT: BOOL
Axis	:= "A1_V1000".AxisData	// Reference to the general axis data	IN-OUT: UDT 879
V1000	:= "A1_V1000".V1000Data	// Reference to the general axis data // of the inverter drive	IN-OUT: UDT 881
AxisComData	:= "ComDataSlaves".Slaves.Slave (1)	// Reference to the communication data	IN-OUT: UDT 878

13.5.4.2.9 OB 1 - Create instance read parameter

With the FB 879 - VMC_ReadParameter_RTU you have read access to the parameters of an inverter drive, which is serially connected via Modbus RTU. For the parameter data a DB is to be created.

1. ➤ For this click at 'Project tree → ...CPU... → PLC program → Program blocks → Add new block'.
 - ⇒ The dialog 'Add block' is opened.
2. ➤ Select the block type 'DB block' and assign it the name "A1_TransferData". The DB number can freely be selected such as DB 98. Specify DB 98 and create this as a global DB with [OK].
 - ⇒ The block is created and opened.
3. ➤ In "A1_TransferData" create the following variables:
 - 'Data_0' of type WORD
 - 'Data_1' of type WORD
 - 'Data_2' of type WORD
 - 'Data_3' of type WORD
4. ➤ Add a Call FB879, DB879 to OB 1.
 - ⇒ The block call is created and a dialog opens to specify the instance data block 'VMC_ReadParameter_RTU'.
5. ➤ Confirm the query of the instance data block with [OK].
6. ➤ Specify the following parameters:

Call FB879, DB879 ↪ Chap. 13.5.7.8 'FB 879 - VMC_ReadParameter_RTU - Modbus RTU read parameters' page 506

Execute	:= "A1_RdParExecute"	// The job is started with edge 0-1.	IN: BOOL
StartAddress	:= "A1_RdParStartAddress"	// Start address of the 1. register	IN: INT
Quantity	:= "A1_RdParQuantity"	// Number of registers to read	IN: INT
Done	:= "A1_RdParDone"	// Status job finished	IN: REAL
Busy	:= "A1_RdParBusy"	// Status job in progress	OUT: BOOL
Error	:= "A1_RdParError"	// Error feedback	OUT: BOOL
ErrorID	:= "A1_RdParErrorID"	// Additional error information	OUT: BOOL
Data	:= P#DB98.DBX0.0 BYTES 8	// Location of the parameter data	OUT: WORD
Axis	:= "A1_V1000".AxisData	// Reference to the general axis data	IN-OUT: UDT 879



Please note that only whole registers can be read as WORD. To evaluate individual bits, you must swap high and low byte!

13.5.4.2.10 OB 1 - Create instance write parameter

With the FB 880 - VMC_WriteParameter_RTU you have write access to the parameters of an inverter drive, which is serially connected via Modbus RTU. For the data you can use the DB created for read access - here DB 98.

1. ➤ Add a Call FB880, DB880 to OB 1.
 - ⇒ The block call is created and a dialog opens to specify the instance data block 'VMC_WriteParameter_RTU'.

Usage inverter drive via Modbus RTU > Usage in VIPA SPEED7 Studio

2. ➤ Confirm the query of the instance data block with [OK].
3. ➤ Specify the following parameters:

Call FB880, DB880 ↪ *Chap. 13.5.7.9 'FB 880 - VMC_WriteParameter_RTU - Modbus RTU write parameters' page 507*

Execute	:= "A1_WrParExecute"	// The job is started with edge 0-1.	IN: BOOL
StartAddress	:= "A1_WrParStartAddress"	// Start address of the 1. register	IN: INT
Quantity	:= "A1_WrParQuantity"	// Number of registers to write	IN: INT
Done	:= "A1_WrParDone"	// Status job finished	IN: REAL
Busy	:= "A1_WrParBusy"	// Status job in progress	OUT: BOOL
Error	:= "A1_WrParError"	// Error feedback	OUT: BOOL
ErrorID	:= "A1_WrParErrorID"	// Additional error information	OUT: BOOL
Data	:= P#DB98.DBX0.0 BYTES 8	// Location of the parameter data	OUT: WORD
Axis	:= "A1_V1000".AxisData	// Reference to the general axis data	IN-OUT: UDT 879

13.5.4.2.11 Sequence of operations

1. ➤ Select *'Project → Compile all'* and transfer the project into your CPU. You can find more information on the transfer of your project in the online help of the *SPEED7 Studio*.
 - ⇒ You can now take your application into operation via the existing communication connection.



CAUTION!

Please always observe the safety instructions for your inverter drive, especially during commissioning!

2. ➤ A watch table allows you to manually control the inverter drive. Double-click at *'Project tree → ...CPU... → PLC program → Watch tables → Add watch table'*.
3. ➤ Enter a name for the watch table such as *'V1000'* and confirm with [OK]
 - ⇒ The watch table is created and opened for editing.
4. ➤ First adjust the waiting time between 2 jobs. This is at least 200ms for a V1000 inverter drive. For this enter in the watch table at *'Name'* the designation *'ComWaitCycles'* as *'Decimal'* and enter at *'Control value'* a value between 200 and 400.



To increase performance, you can later correct this to a smaller value as long as you do not receive a timeout error (80C8h). Please note that some commands, such as MoveVelocity, can consist of several jobs.

5. ➤ Before you can control an inverter drive, it must be initialized with FB 881 - VMC_InitV1000_RTU. ↪ *Chap. 13.5.7.10 'FB 881 - VMC_InitV1000_RTU - Modbus RTU initialization' page 507*

For this enter in the watch table at 'Name' the designation 'A1_InitExecute' as 'Boolean' and enter at 'Control value' the value 'True'. Activate 'Control' and start the transfer of the control values.

- ⇒ The inverter drive is initialized. After execution, the output *Done* returns TRUE. In the event of a fault, you can determine the error by evaluating the *ErrorID*.



Do not continue as long as the Init block reports any errors!

6. ➤ After successful initialization, the registers of the connected inverter drives are cyclically processed, i.e. they receive cyclical jobs. For manual control, you can use the FB 882 - VMC_AxisControlV1000_RTU to send control commands to the appropriate inverter drive. ↪ *Chap. 13.5.7.11 'FB 882 - VMC_AxisControlV1000_RTU - Modbus RTU Axis control' page 509*
7. ➤ Create the parameters of the FB 882 - VMC_AxisControlV1000_RTU for control and query in the watch table.
8. ➤ Activate the corresponding axis by setting *AxisEnable*. As soon as this reports *Axis-Ready* = TRUE, you can control it with the corresponding drive commands.

13.5.5 Usage in Siemens SIMATIC Manager

13.5.5.1 Precondition

Overview

- Please use for configuration the Siemens SIMATIC Manager V 5.5 SP2 and up.
- With a System MICRO CPU, plugging the expansion module activates the PtP functionality. The configuration happens in the Siemens SIMATIC Manager by means of a virtual PROFINET IO device. The PROFINET IO device is to be installed in the hardware catalog by means of a GSDML.
- With a System SLIO 013C CPU the configuration of PtP functionality happens in the Siemens SIMATIC Manager by means of a virtual PROFINET IO device. The PROFINET IO device is to be installed in the hardware catalog by means of a GSDML.
- With the System SLIO CPUs 014 ... 017, the RS485 interface is set to PtP communication as standard. The configuration happens in the Siemens SIMATIC Manager by means of a virtual PROFINET IO device. The PROFINET IO device is to be installed in the hardware catalog by means of a GSDML.

Installing the VIPA IO device

The installation of the PROFINET VIPA IO device happens in the hardware catalog with the following approach:

1. ➤ Go to the service area of www.vipa.com.
2. ➤ Download the configuration file for your CPU from the download area via 'Config files → PROFINET'.
3. ➤ Extract the file into your working directory.
4. ➤ Start the Siemens hardware configurator.
5. ➤ Close all the projects.
6. ➤ Select 'Options → Install new GSD file'.

7. ➤ Navigate to your working directory and install the according GSDML file.
 - ⇒ After the installation the according PROFINET IO device can be found at 'PROFINET IO ➔ Additional field devices ➔ I/O ➔ VIPA ...'.

13.5.5.2 Hardware configuration

13.5.5.2.1 Hardware configuration System MICRO

Add CPU in the project

Slot	Module
1	
2	CPU 314C-2PN/DP
X1	MPI/DP
X2	PN-IO
X2...	Port 1
X2...	Port 2
...	...
3	

To be compatible with the Siemens SIMATIC Manager the following steps should be executed:

1. ➤ Start the Siemens hardware configurator with a new project.
2. ➤ Insert a profile rail from the hardware catalog.
3. ➤ Place at 'Slot'-Number 2 the CPU 314C-2 PN/DP (314-6EH04-0AB0 V3.3).
4. ➤ Click at the sub module 'PN-IO' of the CPU.
5. ➤ Select 'Context menu ➔ Insert PROFINET IO System'.

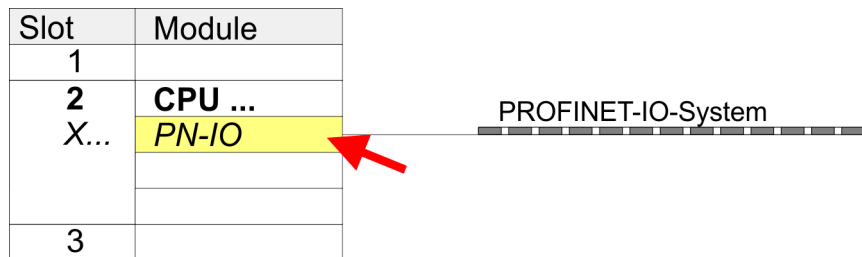

6. ➤ Create with [New] a new sub net and assign valid address data.
7. ➤ Click at the sub module 'PN-IO' of the CPU and open with 'Context menu ➔ Properties' the properties dialog.
8. ➤ Enter at 'General' a 'Device name'. The device name must be unique at the Ethernet subnet.

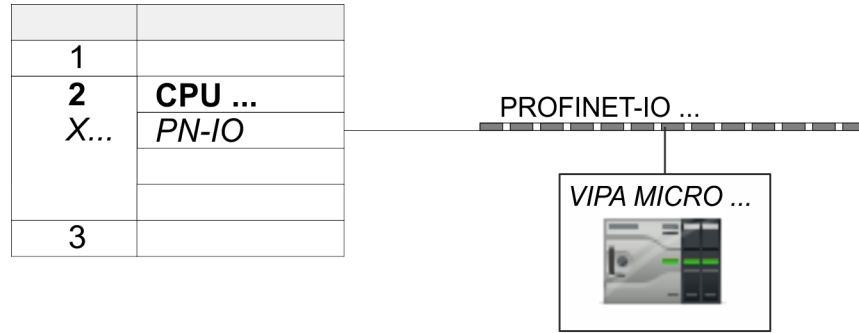

0	VIPA MICRO ...	M13-CCF0000	
X2	M13-CCF0000		
1			
2			
3			
...			

9. ➤ Navigate in the hardware catalog to the directory 'PROFINET IO ➔ Additional field devices ➔ I/O ➔ VIPA ...' and connect e.g. for the System MICRO the IO device 'M13-CCF0000' to your PROFINET system.
 - ⇒ In the *Device overview* of the PROFINET IO device 'VIPA MICRO PLC' the CPU is already placed at slot 0.

Configuration of Ethernet PG/OP channel

Slot	Module
1	
2	CPU ...
X...	PN-IO
3	
4	343-1EX30
5	
...	

1. ➤ Place for the Ethernet PG/OP channel at slot 4 the Siemens CP 343-1 (SIMATIC 300 \ CP 300 \ Industrial Ethernet \ CP 343-1 \ 6GK7 343-1EX30 0XE0 V3.0).
2. ➤ Open the properties dialog by clicking on the CP 343-1EX30 and enter for the CP at 'Properties' the IP address data. You get valid IP address parameters from your system administrator.
3. ➤ Assign the CP to a 'Subnet'. The IP address data are not accepted without assignment!

Enable PtP functionality

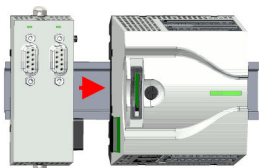

A hardware configuration to enable the PtP functionality is not necessary.

1. ➤ Turn off the power supply.
2. ➤ Mount the extension module.
3. ➤ Establish a cable connection to the communication partner.
4. ➤ Switch on the power supply.
 - ⇒ After a short boot time the interface X1 PtP is ready for PtP communication.

13.5.5.2.2 Hardware configuration System SLIO CPU 013C

Add CPU in the project

Slot	Module
1	
2	CPU 314C-2PN/DP
X1	MPI/DP
X2	PN-IO
X2...	Port 1
X2...	Port 2
...	...
3	

To be compatible with the Siemens SIMATIC Manager the following steps should be executed:

1. Start the Siemens hardware configurator with a new project.
2. Insert a profile rail from the hardware catalog.
3. Place at 'Slot'-Number 2 the CPU 314C-2 PN/DP (314-6EH04-0AB0 V3.3).
4. Click at the sub module 'PN-IO' of the CPU.
5. Select 'Context menu → Insert PROFINET IO System'.

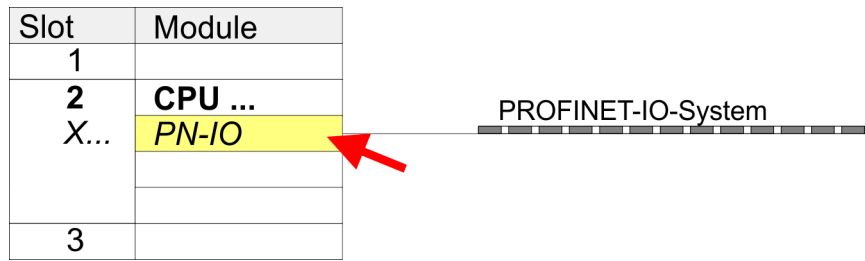

6. Use [New] to create a new subnet and assign valid IP address data for your PROFINET system.
7. Click at the sub module 'PN-IO' of the CPU and open with 'Context menu → Properties' the properties dialog.
8. Enter at 'General' a 'Device name'. The device name must be unique at the Ethernet subnet.

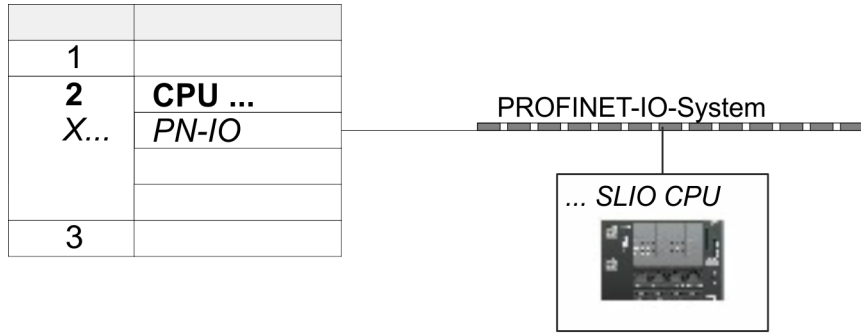

0	... SLIO CPU ...	013-CCF0R00	
X2	013-CCF0R00		
1			
2			
3			
...			

9. Navigate in the hardware catalog to the directory 'PROFINET IO' → 'Additional field devices' → 'I/O' → 'VIPA ...' and connect the IO device '013-CCF0R00' CPU to your PROFINET system.
 - ⇒ In the slot overview of the PROFINET IO device 'VIPA SLIO CPU' the CPU is already placed at slot 0. From slot 1 you can place your System SLIO modules.

Enable PtP functionality

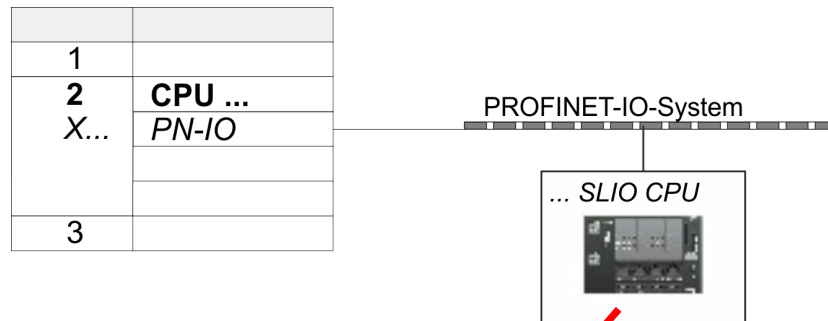

0	... SLIO CPU	013-CCF0R00	
X2	013-CCF0R00		
1			
2			
3			
...			

Properties - ...CPU...

Parameters

- Parameters
 - General Parameters
 - Function X3

PTP

1. Open the properties dialog by a double-click at 'VIPA SLIO CPU'.
 - ⇒ The VIPA specific parameters may be accessed by means of the properties dialog.
2. Select at 'Function X3' the value 'PTP'.

Configuration of Ethernet PG/OP channel

Slot	Module
1	
2	CPU ...
X...	<i>PN-IO</i>
3	
4	343-1EX30
5	
...	

1. ➤ Place for the Ethernet PG/OP channel at slot 4 the Siemens CP 343-1 (SIMATIC 300 \ CP 300 \ Industrial Ethernet \ CP 343-1 \ 6GK7 343-1EX30 0XE0 V3.0).
2. ➤ Open the properties dialog by clicking on the CP 343-1EX30 and enter for the CP at 'Properties' the IP address data. You get valid IP address parameters from your system administrator.
3. ➤ Assign the CP to a 'Subnet'. The IP address data are not accepted without assignment!

13.5.5.2.3 Hardware configuration System SLIO CPU 014 ... 017

Add CPU in the project

Slot	Module
1	
2	CPU 315-2 PN/DP
X1	<i>MPI/DP</i>
X2	<i>PN-IO</i>
X2...	<i>Port 1</i>
X2...	<i>Port 2</i>
...	...
3	

To be compatible with the Siemens SIMATIC Manager the following steps should be executed:

1. ➤ Start the Siemens hardware configurator with a new project.
2. ➤ Insert a profile rail from the hardware catalog.
3. ➤ Place at 'Slot' number 2 the CPU 315-2 PN/DP (315-2EH14-0AB0 V3.2).
4. ➤ Click at the sub module 'PN-IO' of the CPU.

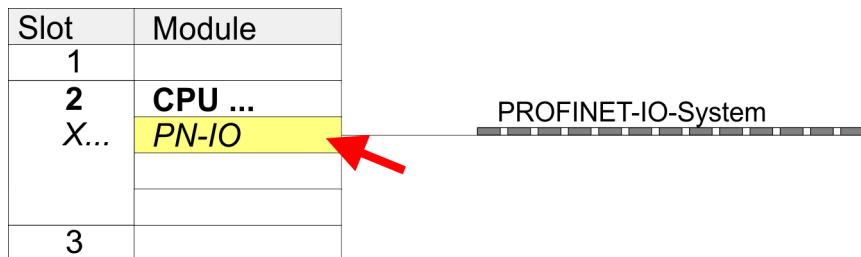

5. ➤ Use [New] to create a new subnet and assign valid IP address data for your PROFINET system.
6. ➤ Click at the sub module 'PN-IO' of the CPU and open with 'Context menu → Properties' the properties dialog.
7. ➤ Enter at 'General' a 'Device name'. The device name must be unique at the Ethernet subnet.

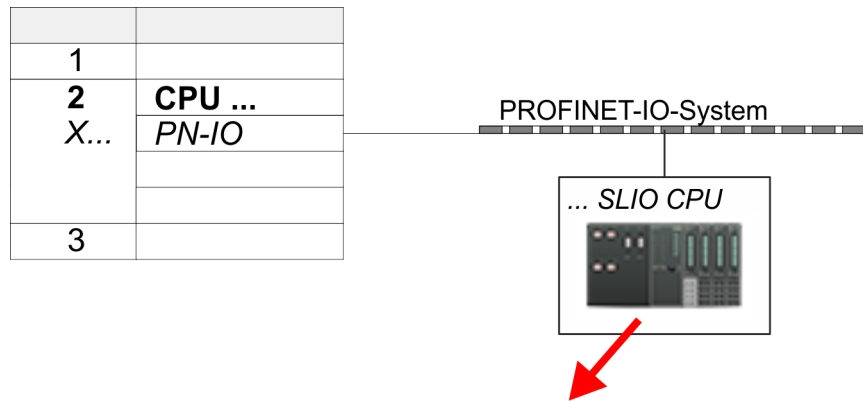

0	... SLIO CPU	
X2	...		
1			
2			
3			
...			

8. ➤ Navigate in the hardware catalog to the directory 'PROFINET IO ➔ Additional field devices ➔ I/O ➔ VIPA ...' and connect the IO device, which corresponds to your CPU, to your PROFINET system.
 - ⇒ In the slot overview of the PROFINET IO device 'VIPA SLIO CPU' the CPU is already placed at slot 0. From slot 1 you can place your System SLIO modules.

Configuration of Ethernet PG/OP channel

Slot	Module
1	
2	CPU ...
X...	PN-IO
3	
4	343-1EX30
5	
...	

1. ➤ Place for the Ethernet PG/OP channel at slot 4 the Siemens CP 343-1 (SIMATIC 300 \ CP 300 \ Industrial Ethernet \ CP 343-1 \ 6GK7 343-1EX30 0XE0 V3.0).
2. ➤ Open the properties dialog by clicking on the CP 343-1EX30 and enter for the CP at 'Properties' the IP address data. You get valid IP address parameters from your system administrator.
3. ➤ Assign the CP to a 'Subnet'. The IP address data are not accepted without assignment!

Enable PtP functionality

For the System SLIO CPUs 014 ... 017, the RS485 interface is set to PtP communication as standard. A hardware configuration to enable the PtP functionality is not necessary.

13.5.5.3 User program

13.5.5.3.1 Program structure

OB 100

FB 876 - VMC_ConfigMaster_RTU
SFC 216 - SER_CFG

- FB 876 - VMC_ConfigMaster_RTU ⚡ 504
 - This block is used to parametrize the serial interface of the CPU for Modbus RTU communication.
 - Internally block SFC 216 - SER_CFG is called.

OB 1

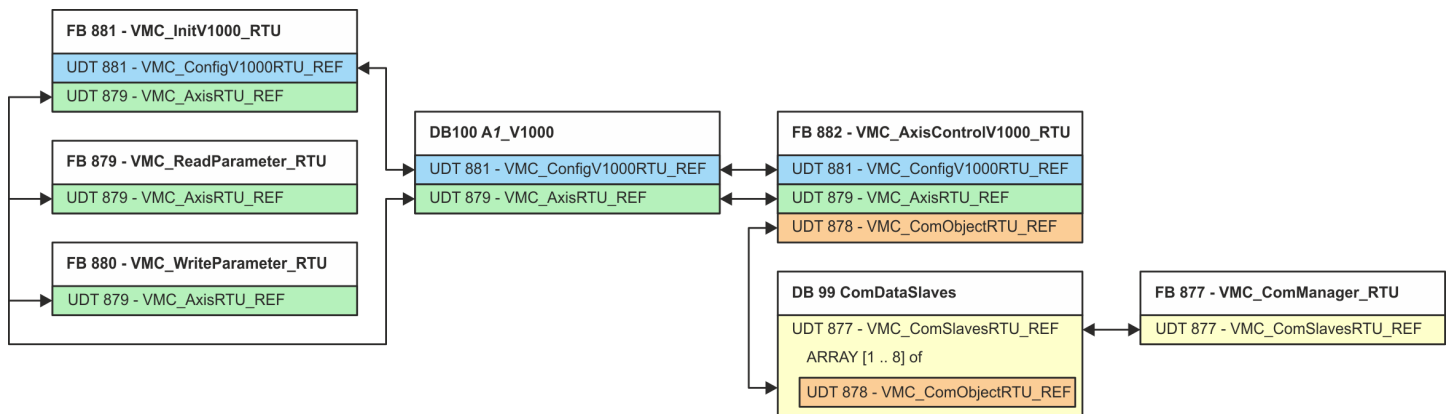

With the exception of blocks DB 99 and FB 877, you must create the blocks listed below for each connected inverter drive:

- FB 881 - VMC_InitV1000_RTU ↗ 507
 - The FB 881 - VMC_InitV1000_RTU initializes the corresponding inverter drive with the user data.
 - Before an inverter drive can be controlled, it must be initialized.
 - UDT 881 - VMC_ConfigV1000RTU_REF ↗ 504
 - UDT 879 - VMC_AxisRTU_REF ↗ 504
- FB 879 - VMC_ReadParameter_RTU ↗ 506
 - With this FB you have read access to the parameters of an inverter drive, which is connected serially via Modbus RTU.
 - The read data are recorded in a data block.
 - UDT 879 - VMC_AxisRTU_REF ↗ 504
- FB 880 - VMC_WriteParameter_RTU ↗ 507
 - With this FB you have read access to the parameters of an inverter drive, which is connected serially via Modbus RTU.
 - The data to be written must be stored in a data block.
 - UDT 879 - VMC_AxisRTU_REF ↗ 504
- DB 100 - A1_V1000
 - For each inverter drive, which is serially connected via Modbus RTU, a data block must be created.
 - UDT 879 - VMC_AxisRTU_REF ↗ 504
 - UDT 881 - VMC_ConfigV1000RTU_REF ↗ 504
- FB 882 - VMC_AxisControlV1000_RTU ↗ 509
 - With this block, you can control an inverter drive, which is serially connected via Modbus RTU and check its status.
 - UDT 881 - VMC_ConfigV1000RTU_REF ↗ 504
 - UDT 879 - VMC_AxisRTU_REF ↗ 504
 - UDT 878 - VMC_ComObjectRTU_REF ↗ 504
- DB 99 - ComDataSlaves
 - For the communication data of all the inverter drives (max. 8), which are serially connected via Modbus RTU, a common data block is to be created.
 - UDT 877 - VMC_ComSlavesRTU_REF ↗ 504
 - UDT 878 - VMC_ComObjectRTU_REF ↗ 504
- FB 877 - VMC_ComManager_RTU ↗ 505
 - The device ensures that only 1 inverter drive (Modbus slave) can use the serial interface. If several inverter drives are used, this block, as communication manager, sends the jobs to the respective Modbus slaves and evaluates their responses.
 - UDT 877 - VMC_ComSlavesRTU_REF ↗ 504

13.5.5.3.2 Copy blocks into project

Include library

1. ➤ Go to the service area of www.vipa.com.
2. ➤ Download the *Simple Motion Control* library from the download area at '*VIPA Lib*'.
3. ➤ Open the dialog window for ZIP file selection via '*File* ➔ *Retrieve*'.
4. ➤ Select the according ZIP file and click at [Open].
5. ➤ Specify a target directory in which the blocks are to be stored and start the unzip process with [OK].

Copy blocks into project

- Open the library after unzipping and drag and drop all the blocks of '*V1000 Modbus RTU*' into '*Blocks*' of your project:
- FB 876 - VMC_ConfigMaster_RTU
 - FB 877 - VMC_ComManager_RTU
 - FB 878 - VMC_RWParameterSys_RTU
 - FB 879 - VMC_ReadParameter_RTU
 - FB 880 - VMC_WriteParameter_RTU
 - FB 881 - VMC_InitV1000_RTU
 - FB 882 - VMC_AxisControlV1000_RTU
 - FB 60 - SEND
 - FB 61 - RECEIVE
 - FB 72 - RTU MB_MASTER
 - FC 216 - SER_CFG
 - FC 217 - SER_SND
 - FC 218 - SER_RCV
 - UDT 877 - VMC_ComSlavesRTU_REF
 - UDT 878 - VMC_ComObjectRTU_REF
 - UDT 879 - VMC_AxisRTU_REF
 - UDT 881 - VMC_ConfigV1000RTU_REF
 - SFB 4 - TON

13.5.5.3.3 Create OB 100 for serial communication

Create interrupt OBs

1. ➤ In your project, click at '*Blocks*' and choose '*Context menu* ➔ *Insert new object* ➔ *Organization block*'.
 - ⇒ The dialog '*Properties Organization block*' opens.
2. ➤ Add the OB 100 to your project.
3. ➤ Open the OB 100.
4. ➤ Add a `Call FB876, DB876` to the OB 100.
 - ⇒ The block call is created and a dialog opens to specify the instance data block '*VMC_ConfigMaster_RTU_876*'.
5. ➤ Specify the following parameters:

`Call FB876, DB876` ↪ *Chap. 13.5.7.5 'FB 876 - VMC_ConfigMaster_RTU - Modbus RTU CPU interface' page 504*

Baudrate	:= B#16#09	// Baud rate: 09h (9600bit/s)	IN: BYTE
CharLen	:= B#16#03	// Number data bits: 03h (8bit)	IN: BYTE
Parity	:= B#16#00	// Parity: 0 (none)	IN: BYTE
StopBits	:= B#16#01	// Stop bits: 1 (1bit)	IN: BYTE

Usage inverter drive via Modbus RTU > Usage in Siemens SIMATIC Manager

TimeOut	:= W#16#1FFF	// Error wait time: 1FFFh (high selected)	IN: WORD
Valid	:= "ModbusConfigValid"	// Configuration	OUT BOOL
Error	:= "ModbusConfigError"	// Error feedback	OUT BOOL
ErrorID	:= "ModbusConfigErrorID"	// Additional error information	OUT: WORD

Symbolic variable

You create the symbolic variables via *'Context menu → Edit symbol'*. Here you can assign the corresponding operand via a dialog.

13.5.5.3.4 Create data block for Modbus slave

For each inverter drive, which is serially connected via Modbus RTU, a data block must be created.

1. In your project, click at *'Blocks'* and choose *'Context menu → Insert new object → Data block'*.

⇒ The dialog *'Add block'* is opened.

2. Specify the following parameters:

- Name and type
 - The DB number as *'Name'* can freely be chosen, such as DB 100. Enter DB 100.
 - Set *'Shared DB'* as the *'Type'*.
- Symbolic name
 - Enter "A1_V1000".

Confirm your input with [OK].

⇒ The block is created.

3. Open DB 100 "A1_V1000" by double-clicking.

4. In "A1_V1000" create the following variables:

- *'AxisData'* of type UDT 879 - VMC_AxisRTU_REF
- *'V1000Data'* of type UDT 881 - VMC_ConfigV1000RTU_REF

13.5.5.3.5 Create data block for all Modbus slaves

For the communication data of the inverter drives, which are serially connected via Modbus RTU, a common data block is to be created.

1. In your project, click at *'Blocks'* and choose *'Context menu → Insert new object → Data block'*.

⇒ The dialog *'Add block'* is opened.

2. Specify the following parameters:

- Name and type
 - The DB number as *'Name'* can freely be chosen, such as DB 99. Enter DB 99.
 - Set *'Shared DB'* as the *'Type'*.
- Symbolic name
 - Enter "ComDataSlaves".

Confirm your input with [OK].

⇒ The block is created.

3. ➤ Open DB 99 "ComDataSlaves" by double-clicking.
4. ➤ In "ComDataSlaves" create the following variable:
 - 'Slaves' of Type UDT 877 - VMC_ComSlavesRTU_REF

13.5.5.3.6 OB 1 - Create instance of communication manager

The FB 877 - VMC_ComManager_RTU ensures that only 1 inverter drive (Modbus slave) can use the serial interface. As a communication manager, the block sends the jobs to the respective Modbus slaves and evaluates their responses.

1. ➤ Open the OB 1.
2. ➤ Add a Call FB877, DB877 to OB 1.
 - ⇒ The block call is created and a dialog opens to specify the instance data block 'VMC_ComManager_RTU_877'.
3. ➤ Confirm the query of the instance data block with [OK].
4. ➤ Specify the following parameters:

Call FB877, DB877 ↪ *Chap. 13.5.7.6 'FB 877 - VMC_ComManager_RTU - Modbus RTU communication manager' page 505*

NumberOfSlaves	:= 1	// Number of connected inverter drives: 1	IN: INT
WaitCycles	:= "ComWaitCycles"	// Minimum number of waiting cycles	IN: DINT
SlavesComData	:= "ComDataSlaves.Slave"	// Reference to all communication objects	IN-OUT: UDT 877

13.5.5.3.7 OB 1 - Create instance of the V1000 initialization

The FB 881 - VMC_InitV1000_RTU initializes the corresponding inverter drive with the user data. Before an inverter drive can be controlled, it must be initialized.

1. ➤ Add a Call FB881, DB881 to OB 1.
 - ⇒ The block call is created and a dialog opens to specify the instance data block 'VMC_InitV1000_RTU_881'.
2. ➤ Confirm the query of the instance data block with [OK].
3. ➤ Specify the following parameters:

Call FB881, DB881 ↪ *Chap. 13.5.7.10 'FB 881 - VMC_InitV1000_RTU - Modbus RTU initialization' page 507*

Execute	:= "A1_InitExecute"	// The job is started with edge 0-1.	IN: BOOL
Hardware	:= "A1_InitHardware"	// Specification of the hardware, used // 1: System SLIO CP040, 2: SPEED7 CPU	IN: BYTE
Laddr	:= "A1_InitLaddr"	// Logical address when using CP040	IN: INT
UnitId	:= "A1_InitUnitId"	// Modbus address of the V1000	IN: BYTE
UserUnitsVelocity	:= "A1_InitUserUnitsVel"	// User unit for velocities: // 0: Hz, 1: %, 2: RPM	IN: INT
UserUnitsAcceleration	:= "A1_InitUserUnitsAcc"	// User units acceleration/deceleration // 0: 0.01s, 1: 0.1s	IN: INT
MaxVelocityApp	:= "A1_InitMaxVelocityApp"	// Max. velocity in user units	IN: REAL
Done	:= "A1_InitDone"	// Status job finished	OUT: BOOL

Usage inverter drive via Modbus RTU > Usage in Siemens SIMATIC Manager

Busy	:= "A1_InitBusy"	// Status job in progress	OUT: BOOL
Error	:= "A1_InitError"	// Error feedback	OUT: BOOL
ErrorID	:= "A1_InitErrorID"	// Additional error information	OUT: WORD
Axis	:= "A1_V1000".AxisData	// Reference to the general axis data	IN-OUT: UDT 879
V1000	:= "A1_V1000".V1000Data	// Reference to the drive-specific data	IN-OUT: UDT 881

Input values

All parameters must be interconnected with the corresponding variables or operands. The following input parameters must be pre-assigned:

- **Hardware**
Here specify the hardware you use to control your inverter drives:
 - 1: System SLIO CP040 whose logical address is to be specified via *Laddr*.
 - 2: SPEED7 CPU
- **Laddr**
 - Logical address for the System SLIO CP040 (*Hardware* = 1). Otherwise, this parameter is ignored.
- **UnitId**
 - Modbus address of the *V1000*.
- **UserUnitsVelocity**
User unit for speeds:
 - 0: Hz
Specified in hertz
 - 1: %
Specified as a percentage of the maximum speed
= $2 \cdot f_{\max} / P$
with f_{\max} : max. output frequency (parameter E1-04)
p: Number of motor poles (motor-dependent parameter E2-04, E4-04 or E5-04)
 - 2: RPM
Data in revolutions per minute
- **UserUnitsAcceleration**
User units for acceleration and deceleration
 - 0: 0.01s (range of values: 0.00s - 600.00s)
 - 1: 0.1s (range of values: 0.0 - 6000.0s)
- **MaxVelocityApp**
Max. speed for the application. The specification must be made in user units and is used for synchronization in movement commands.

13.5.5.3.8 OB 1 - Create instance axis control V1000

With the FB 882 - VMC_AxisControlV1000_RTU you can control an inverter drive, which is serially connected via Modbus RTU and check its status.

1. ➤ Add a Call FB882, DB882 to OB 1.
 - ⇒ The block call is created and a dialog opens to specify the instance data block 'VMC_AxisControlV1000_RTU_882'.
2. ➤ Confirm the query of the instance data block with [OK].
3. ➤ Specify the following parameters:

Call FB882, DB882 ↗ *Chap. 13.5.7.11 'FB 882 - VMC_AxisControlV1000_RTU - Modbus RTU Axis control' page 509*

AxisEnable	:= "A1_AxisEnable"	// Activation of the axis	IN: BOOL
------------	--------------------	---------------------------	----------

AxisReset	:= "A1_AxisReset"	// Command: Reset error of the V1000.	IN: BOOL
StopExecute	:= "A1_StopExecute"	// Command: Stop - Stop axis	IN: BOOL
MvVelocityExecute	:= "A1_MvVelocityExecute"	// Command: MoveVelocity (velocity control)	IN: BOOL
Velocity	:= "A1_Velocity"	// Parameter: Velocity setting for MoveVelocity	IN: REAL
AccelerationTime	:= "A1_AccelerationTime"	// Parameter: Acceleration time	IN: REAL
DecelerationTime	:= "A1_DecelerationTime"	// Parameter: Deceleration time	IN: REAL
JogPositive	:= "A1_JogPositive"	// Command: JogPos	IN: BOOL
JogNegative	:= "A1_JogNegative"	// Command: JogNeg	IN: BOOL
JogVelocity	:= "A1_JogVelocity"	// Parameter: Velocity setting for jogging	IN: REAL
JogAccelerationTime	:= "A1_JogAccelerationTime"	// Parameter: Acceleration time for jogging	IN: REAL
JogDecelerationTime	:= "A1_JogDecelerationTime"	// Parameter: Deceleration time for jogging	IN: REAL
AxisReady	:= "A1_AxisReady"	// Status: Axis ready	OUT: BOOL
AxisEnabled	:= "A1_AxisEnabled"	// Status: Activation of the axis	OUT: BOOL
AxisError	:= "A1_AxisError"	// Status: Axis error	OUT: BOOL
AxisErrorID	:= "A1_AxisErrorID"	// Status: Additional error information for AxisError	OUT: WORD
DriveError	:= "A1_DriveError"	// Status: Error on the inverter drive	OUT: BOOL
ActualVelocity	:= "A1_ActualVelocity"	// Status: Current velocity	OUT: REAL
InVelocity	:= "A1_InVelocity"	// Status target velocity	OUT: BOOL
CmdDone	:= "A1_CmdDone"	// Status: Command finished	OUT: BOOL
CmdBusy	:= "A1_CmdBusy"	// Status: Command in progress	OUT: BOOL
CmdAborted	:= "A1_CmdAborted"	// Status: Command aborted	OUT: BOOL
CmdError	:= "A1_CmdError"	// Status: Command error	OUT: BOOL
CmdErrorID	:= "A1_CmdErrorID"	// Status: Additional error information for CmdError	OUT: WORD
CmdActive	:= "A1_CmdActive"	// Status: Active command	OUT: INT
DirectionPositive	:= "A1_DirectionPositive"	// Status: Direction of rotation positive	OUT: BOOL
DirectionNegative	:= "A1_DirectionNegative"	// Status: Direction of rotation negative	OUT: BOOL
Axis	:= "A1_V1000".AxisData	// Reference to the general axis data	IN-OUT: UDT 879
V1000	:= "A1_V1000".V1000Data	// Reference to the general axis data // of the inverter drive	IN-OUT: UDT 881
AxisComData	:= "ComDataSlaves".Slaves.Slave (1)	// Reference to the communication data	IN-OUT: UDT 878

13.5.5.3.9 OB 1 - Create instance read parameter

With the FB 879 - VMC_ReadParameter_RTU you have read access to the parameters of an inverter drive, which is serially connected via Modbus RTU. For the parameter data a DB is to be created.

1.  In your project, click at 'Blocks' and choose 'Context menu → Insert new object → Data block'.

⇒ The dialog 'Add block' is opened.

2. Specify the following parameters:

- Name and type
 - The DB no. as 'Name' can freely be chosen, such as DB 98. Enter DB 98.
 - Set 'Shared DB' as the 'Type'.
- Symbolic name
 - Enter "A1_TransferData".

Confirm your input with [OK].

⇒ The block is created.

3. Open DB 98 "A1_TransferData" by double-clicking.**4.** In "A1_TransferData" create the following variables:

- 'Data_0' of type WORD
- 'Data_1' of type WORD
- 'Data_2' of type WORD
- 'Data_3' of type WORD

5. Add a Call FB879, DB879 to OB 1.

⇒ The block call is created and a dialog opens to specify the instance data block 'VMC_ReadParameter_RTU'.

6. Confirm the query of the instance data block with [OK].**7.** Specify the following parameters:

Call FB879, DB879 ↪ *Chap. 13.5.7.8 'FB 879 - VMC_ReadParameter_RTU - Modbus RTU read parameters' page 506*

Execute	:= "A1_RdParExecute"	// The job is started with edge 0-1.	IN: BOOL
StartAddress	:= "A1_RdParStartAddress"	// Start address of the 1. register	IN: INT
Quantity	:= "A1_RdParQuantity"	// Number of registers to read	IN: INT
Done	:= "A1_RdParDone"	// Status job finished	IN: REAL
Busy	:= "A1_RdParBusy"	// Status job in progress	OUT: BOOL
Error	:= "A1_RdParError"	// Error feedback	OUT: BOOL
ErrorID	:= "A1_RdParErrorID"	// Additional error information	OUT: BOOL
Data	:= P#DB98.DBX0.0 BYTES 8	// Location of the parameter data	OUT: WORD
Axis	:= "A1_V1000".AxisData	// Reference to the general axis data	IN-OUT: UDT 879



Please note that only whole registers can be read as WORD. To evaluate individual bits, you must swap high and low byte!

13.5.5.3.10 OB 1 - Create instance write parameter

With the FB 880 - VMC_WriteParameter_RTU you have write access to the parameters of an inverter drive, which is serially connected via Modbus RTU. For the data you can use the DB created for read access - here DB 98.

1. Add a Call FB880, DB880 to OB 1.

⇒ The block call is created and a dialog opens to specify the instance data block 'VMC_WriteParameter_RTU'.

2. Confirm the query of the instance data block with [OK].

3. Specify the following parameters:

Call FB880, DB880 ↪ *Chap. 13.5.7.9 'FB 880 - VMC_WriteParameter_RTU - Modbus RTU write parameters' page 507*

Execute	:= "A1_WrParExecute"	// The job is started with edge 0-1.	IN: BOOL
StartAddress	:= "A1_WrParStartAddress"	// Start address of the 1. register	IN: INT
Quantity	:= "A1_WrParQuantity"	// Number of registers to write	IN: INT
Done	:= "A1_WrParDone"	// Status job finished	IN: REAL
Busy	:= "A1_WrParBusy"	// Status job in progress	OUT: BOOL
Error	:= "A1_WrParError"	// Error feedback	OUT: BOOL
ErrorID	:= "A1_WrParErrorID"	// Additional error information	OUT: BOOL
Data	:= P#DB98.DBX0.0 BYTES 8	// Location of the parameter data	OUT: WORD
Axis	:= "A1_V1000".AxisData	// Reference to the general axis data	IN-OUT: UDT 879

13.5.5.3.11 Sequence of operations

1. Safe your project with '*Station → Safe and compile*'.
2. Transfer your project to your CPU.
 - ⇒ You can take your application into operation now.



CAUTION!

Please always observe the safety instructions for your inverter drive, especially during commissioning!

3. A watch table allows you to manually control the inverter drive. To create a watch table, choose '*PLC → Monitor/Modify variables*'.
 - ⇒ The watch table is created and opened for editing.
4. First adjust the waiting time between 2 jobs. This is at least 200ms for a V1000 inverter drive. For this enter in the watch table at '*Symbol*' the designation '*ComWaitCycles*' as '*Decimal*' and enter at '*Control value*' a value between 200 and 400.



To increase performance, you can later correct this to a smaller value as long as you do not receive a timeout error (80C8h). Please note that some commands, such as *MoveVelocity*, can consist of several jobs.

5. ➤ Before you can control an inverter drive, it must be initialized with FB 881 - VMC_InitV1000_RTU. ↪ *Chap. 13.5.7.10 'FB 881 - VMC_InitV1000_RTU - Modbus RTU initialization' page 507*

For this enter in the watch table at 'Symbol' the designation 'A1_InitExecute' as 'Boolean' and enter at 'Control value' the value 'True'. Activate 'Control' and start the transfer of the control values.

- ⇒ The inverter drive is initialized. After execution, the output *Done* returns TRUE. In the event of a fault, you can determine the error by evaluating the *ErrorID*.



Do not continue as long as the Init block reports any errors!

6. ➤ After successful initialization, the registers of the connected inverter drives are cyclically processed, i.e. they receive cyclical jobs. For manual control, you can use the FB 882 - VMC_AxisControlV1000_RTU to send control commands to the appropriate inverter drive. ↪ *Chap. 13.5.7.11 'FB 882 - VMC_AxisControlV1000_RTU - Modbus RTU Axis control' page 509*
7. ➤ Create the parameters of the FB 882 - VMC_AxisControlV1000_RTU for control and query in the watch table.
8. ➤ Save the watch table under a name such as 'V1000'.
9. ➤ Activate the corresponding axis by setting *AxisEnable*. As soon as this reports *Axis-Ready* = TRUE, you can control it with the corresponding drive commands.

13.5.6 Usage in Siemens TIA Portal

13.5.6.1 Precondition

Overview

- Please use the Siemens TIA Portal V 14 and up for the configuration.
- With a System MICRO CPU, plugging the expansion module activates the PtP functionality. The configuration happens in the Siemens TIA Portal by means of a virtual PROFINET IO device. The PROFINET IO device is to be installed in the hardware catalog by means of a GSDML.
- With a System SLIO 013C CPU the configuration of PtP functionality happens in the Siemens TIA Portal by means of a virtual PROFINET IO device. The PROFINET IO device is to be installed in the hardware catalog by means of a GSDML.
- With the System SLIO CPUs 014 ... 017, the RS485 interface is set to PtP communication as standard. The configuration happens in the Siemens TIA Portal by means of a virtual PROFINET IO device. The PROFINET IO device is to be installed in the hardware catalog by means of a GSDML.

Installing the VIPA IO device

The installation of the PROFINET VIPA IO device happens in the hardware catalog with the following approach:

1. ➤ Go to the service area of www.vipa.com.
2. ➤ Download the configuration file for your CPU from the download area via 'Config files → PROFINET'.
3. ➤ Extract the file into your working directory.
4. ➤ Start the Siemens TIA Portal.
5. ➤ Close all the projects.
6. ➤ Switch to the *Project view*.
7. ➤ Select 'Options → Install general station description file (GSD)'.

- 8.** → Navigate to your working directory and install the according GSDML file.
- ⇒ After the installation the hardware catalog is refreshed and the Siemens TIA Portal is closed.
- After restarting the Siemens TIA Portal the according PROFINET IO device can be found at *Other field devices > PROFINET > IO > VIPA GmbH >*



Thus, the VIPA components can be displayed, you have to deactivate the "Filter" of the hardware catalog.

13.5.6.2 Hardware configuration

13.5.6.2.1 Hardware configuration System MICRO

Add CPU in the project

To be compatible with the Siemens SIMATIC TIA Portal the following steps should be executed:

- 1.** → Start the Siemens TIA Portal with a new project.
 - 2.** → Switch to the *Project view*.
 - 3.** → Click in the *Project tree* at 'Add new device'.
 - 4.** → Select the following CPU in the input dialog:
SIMATIC S7-300 > CPU 314C-2 PN/DP (314-6EH04-0AB0 V3.3)
- ⇒ The CPU is inserted with a profile rail.

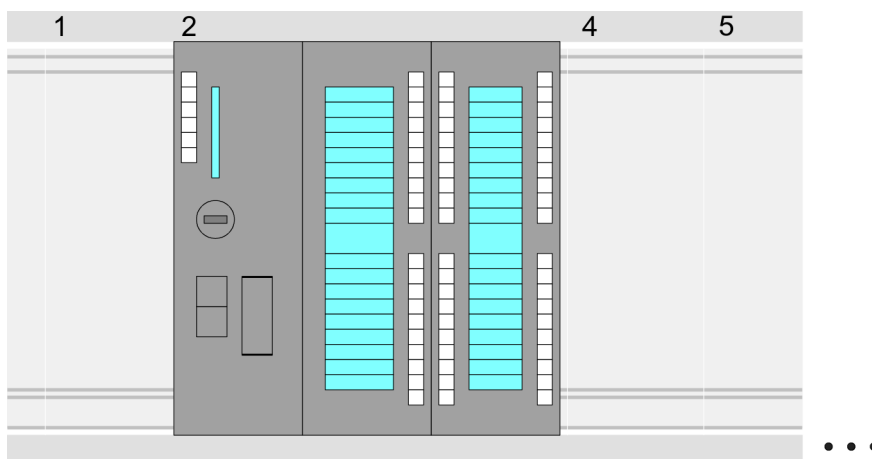

Device overview:

Module	...	Slot	...	Type	...
PLC...		2		CPU 314C-2PN/DP	
MPI interface...		2 X1		MPI/DP interface	
PROFINET inter- face...		2 X2		PROFINET interface	
DI24/DO16...		2 5		DI24/DO16	
AI5/AO2...		2 6		AI5/AO2	

Count...	27	Count	
...			

Connection CPU as PROFINET IO device

1. ➤ Switch in the *Project area* to *'Network view'*.
2. ➤ After installing the GSDML the IO device for the SLIO CPU may be found in the hardware catalog at *Other field devices > PROFINET > IO > VIPA GmbH > VIPA MICRO PLC*. Connect the slave system to the CPU by dragging&dropping it from the hardware catalog to the *Network view* and connecting it via PROFINET to the CPU.
3. ➤ Click in the *Network view* at the PROFINET part of the Siemens CPU and enter at valid IP address data in *'Properties'* at *'Ethernet address'* in the area *'IP protocol'*.
4. ➤ Enter at *'PROFINET'* a *'PROFINET device name'*. The device name must be unique at the Ethernet subnet.

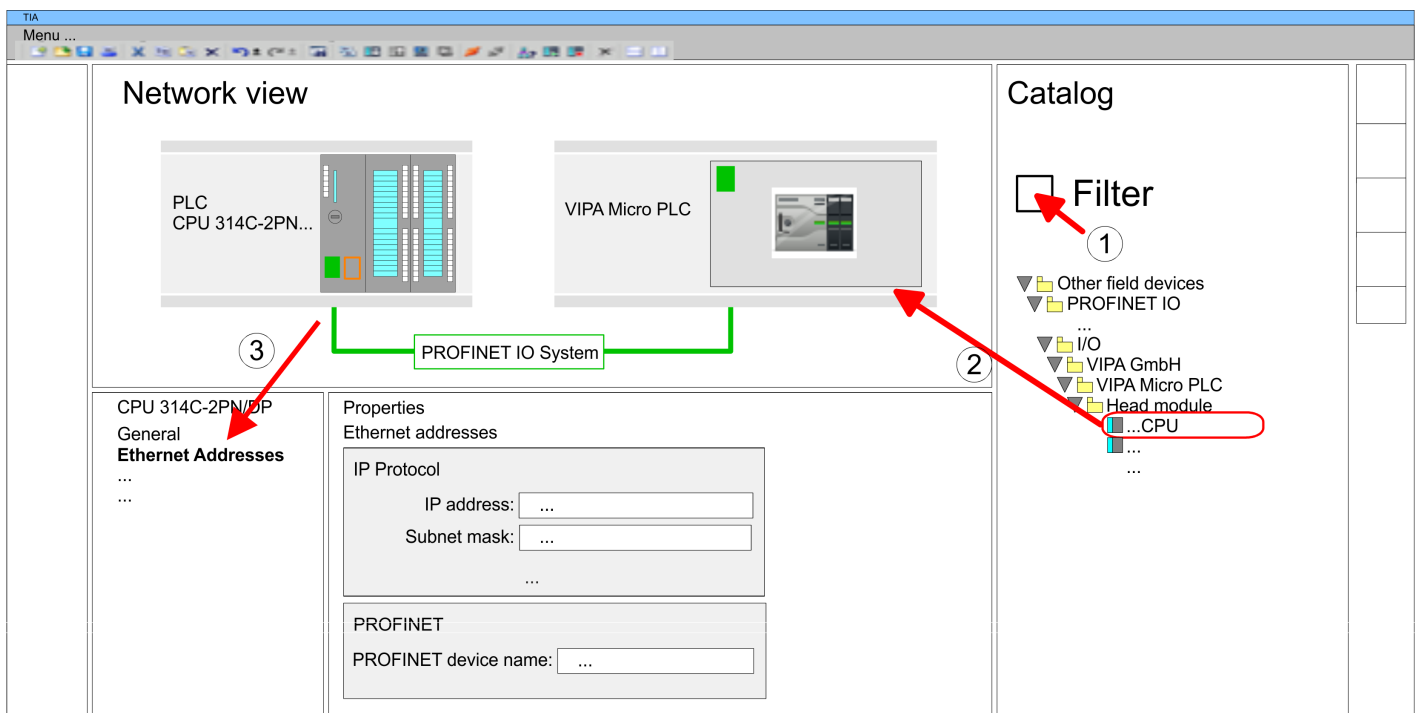

5. ➤ Select in the *Network view* the IO device *'VIPA MICRO PLC'* and switch to the *Device overview*.
 - ⇒ In the *Device overview* of the PROFINET IO device *'VIPA MICRO PLC'* the CPU is already placed at slot 0.

Enable PtP functionality

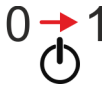
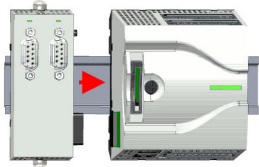
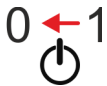

A hardware configuration to enable the PtP functionality is not necessary.

1. Turn off the power supply.
2. Mount the extension module.
3. Establish a cable connection to the communication partner.
4. Switch on the power supply.
 - ⇒ After a short boot time the interface X1 PtP is ready for PtP communication.

Configuration of Ethernet PG/OP channel

1. As Ethernet PG/OP channel place at slot 4 the Siemens CP 343-1 (6GK7 343-1EX30 0XE0 V3.0).
2. Open the "Property" dialog by clicking on the CP 343-1EX30 and enter for the CP at "Properties" at "Ethernet address" the IP address data, which you have assigned before. You get valid IP address parameters from your system administrator.

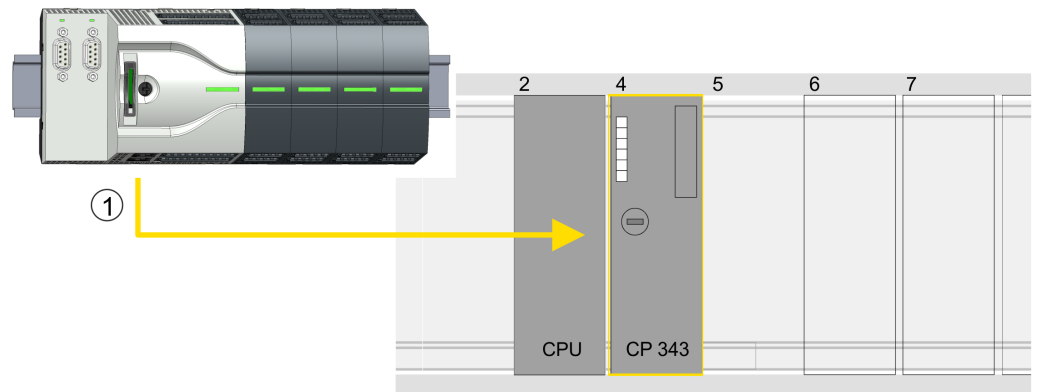

1 Ethernet PG/OP channel

Device overview

Module	...	Slot	...	Type	...
PLC ...		2		CPU 314C-2PN/DP	
MPI/DP interface		2 X1		MPI/DP interface	
PROFINET inter- face		2 X2		PROFINET interface	
...		
CP 343-1		4		CP 343-1	
...		

13.5.6.2.2 Hardware configuration System SLIO CPU 013C

Add CPU in the project

To be compatible with the Siemens SIMATIC TIA Portal the following steps should be executed:

1. ➤ Start the Siemens TIA Portal with a new project.
2. ➤ Switch to the *Project view*.
3. ➤ Click in the *Project tree* at 'Add new device'.
4. ➤ Select the following CPU in the input dialog:
SIMATIC S7-300 > CPU 314C-2 PN/DP (314-6EH04-0AB0 V3.3)
⇒ The CPU is inserted with a profile rail.

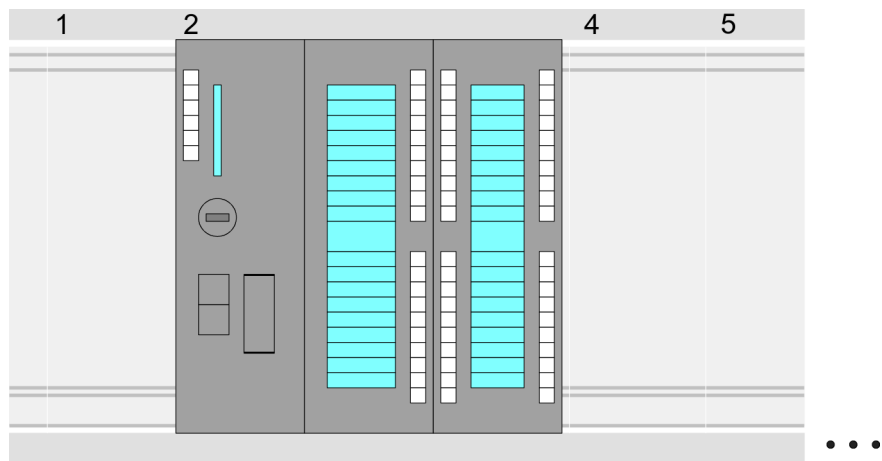

Device overview:

Module	...	Slot	...	Type	...
PLC...		2		CPU 314C-2PN/DP	
MPI interface...		2 X1		MPI/DP interface	
PROFINET inter- face...		2 X2		PROFINET interface	
DI24/DO16...		2 5		DI24/DO16	
AI5/AO2...		2 6		AI5/AO2	
Count...		2 7		Count	
...					

Connection CPU as PROFINET IO device

1. ➤ Switch in the *Project area* to 'Network view'.
2. ➤ After installing the GSDML the IO device for the SLIO CPU may be found in the hardware catalog at *Other field devices > PROFINET > IO > VIPA GmbH > VIPA SLIO System*. Connect the slave system to the CPU by dragging&dropping it from the hardware catalog to the *Network view* and connecting it via PROFINET to the CPU.
3. ➤ Click in the *Network view* at the PROFINET part of the Siemens CPU and enter at valid IP address data in 'Properties' at 'Ethernet address' in the area 'IP protocol'.
4. ➤ Enter at 'PROFINET' a 'PROFINET device name'. The device name must be unique at the Ethernet subnet.

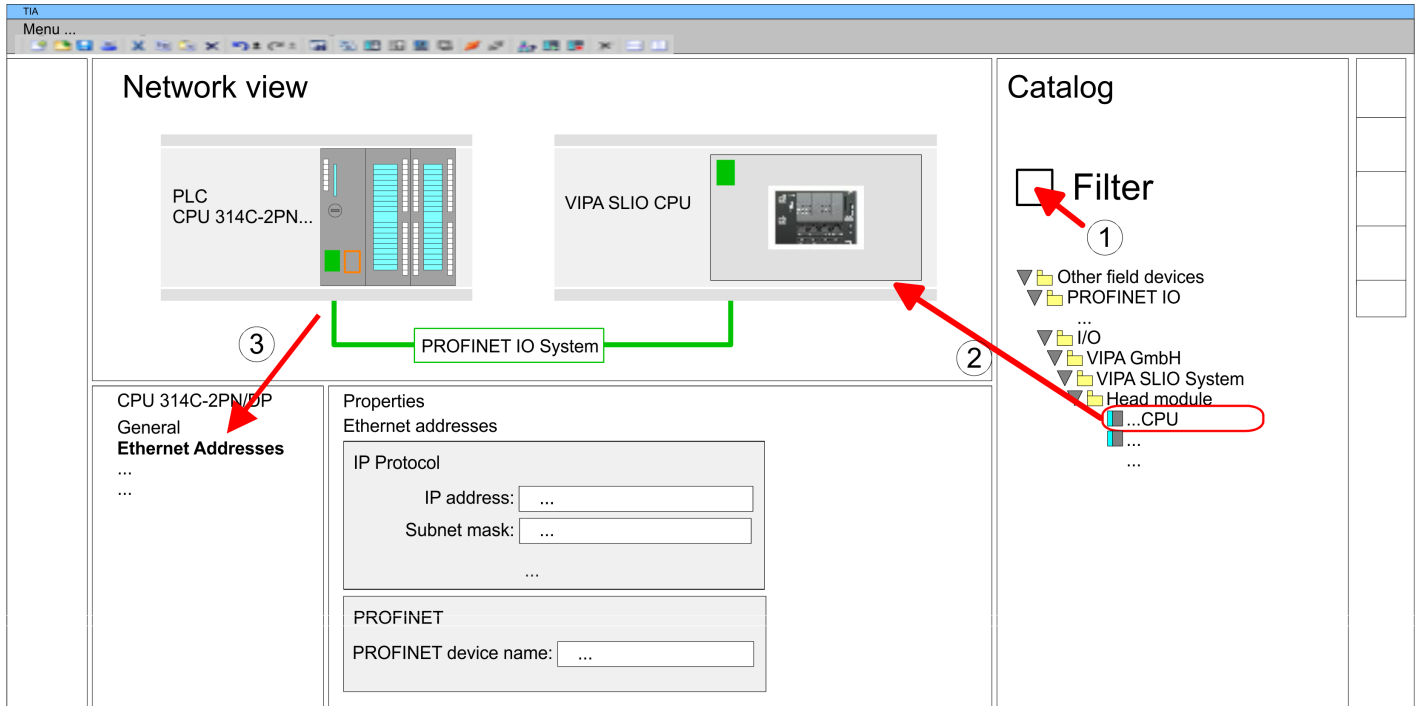

5. ➤ Select in the *Network view* the IO device 'VIPA SLIO CPU' and switch to the *Device overview*.
 ⇒ In the *Device overview* of the PROFINET IO device 'VIPA SLIO CPU' the CPU is already placed at slot 0.

Enable PtP functionality

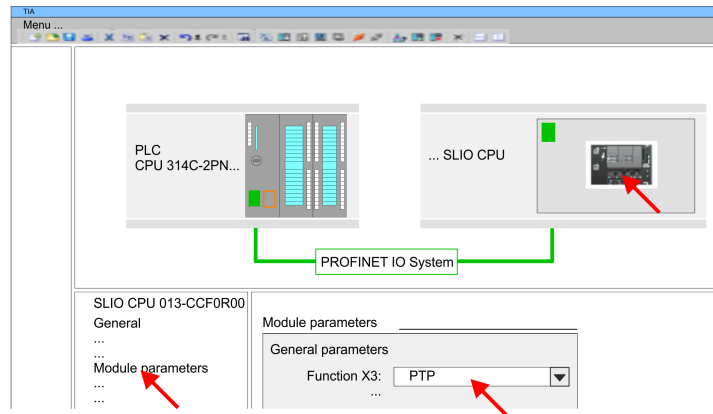

1. ➤ Open the properties dialog by a double-click at 'VIPA SLIO CPU'.
2. ➤ Select at 'Function X3' the value 'PTP'.

Configuration of Ethernet PG/OP channel

1. ➤ As Ethernet PG/OP channel place at slot 4 the Siemens CP 343-1 (6GK7 343-1EX30 0XE0 V3.0).
2. ➤ Open the "Property" dialog by clicking on the CP 343-1EX30 and enter for the CP at "Properties" at "Ethernet address" the IP address data, which you have assigned before. You get valid IP address parameters from your system administrator.

Usage inverter drive via Modbus RTU > Usage in Siemens TIA Portal

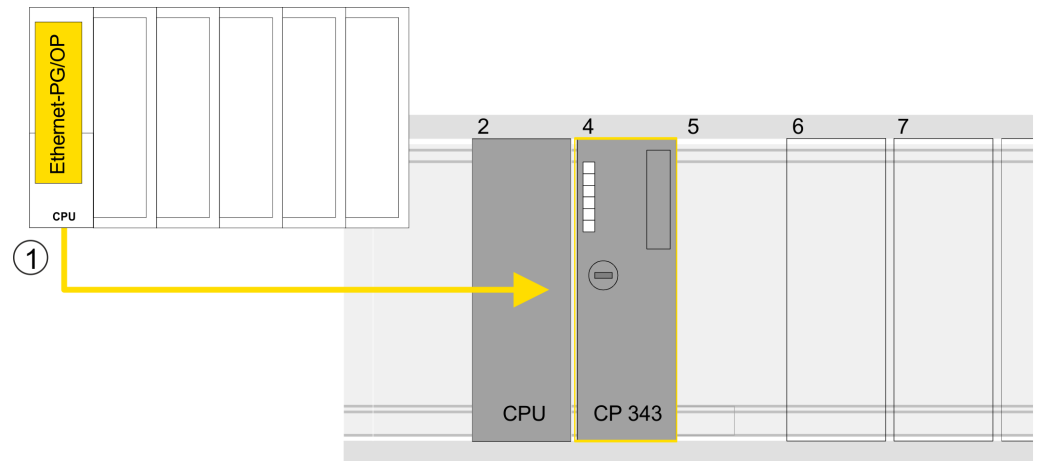

1 Ethernet PG/OP channel

Device overview

Module	...	Slot	...	Type	...
PLC ...		2		CPU 315-2 PN/DP	
MPI/DP interface		2 X1		MPI/DP interface	
PROFINET inter- face		2 X2		PROFINET interface	
...		
CP 343-1		4		CP 343-1	
...		

13.5.6.2.3 Hardware configuration System SLIO CPU 014 ... 017

Add CPU in the project

To be compatible with the Siemens SIMATIC TIA Portal the following steps should be executed:

1. ➤ Start the Siemens TIA Portal with a new project.
2. ➤ Switch to the *Project view*.
3. ➤ Click in the *Project tree* at 'Add new device'.

4. ➤ Select the following CPU in the input dialog:
SIMATIC S7-300 > CPU 315-2 PN/DP (315-2EH14-0AB0 V3.2)
⇒ The CPU is inserted with a profile rail.

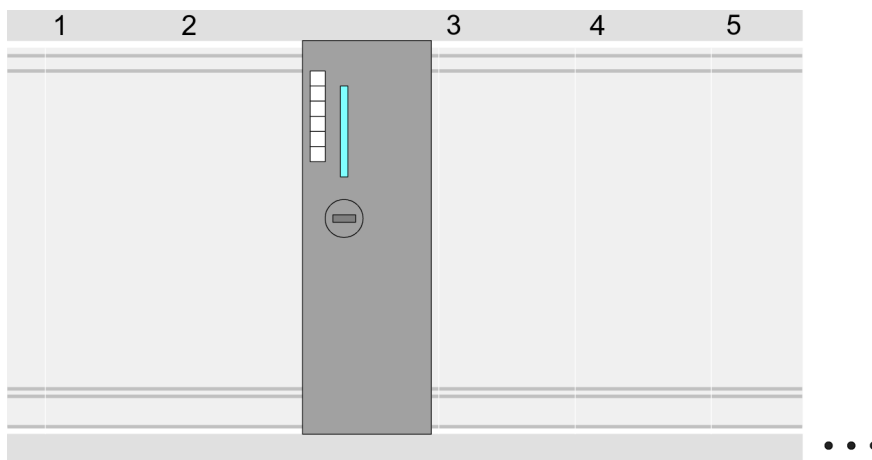

Device overview

Module	...	Slot	...	Type	...
PLC ...		2		CPU 315-2 PN/DP	
MPI/DP interface		2 X1		MPI/DP interface	
PROFINET inter- face		2 X2		PROFINET interface	
...		

Connection CPU as PROFINET IO device

1. ➤ Switch in the *Project area* to 'Network view'.
2. ➤ After installing the GSDML the IO device for the SLIO CPU may be found in the hardware catalog at *Other field devices > PROFINET > IO > VIPA GmbH > VIPA SLIO System*. Connect the slave system to the CPU by dragging&dropping it from the hardware catalog to the *Network view* and connecting it via PROFINET to the CPU.
3. ➤ Click in the *Network view* at the PROFINET part of the Siemens CPU and enter at valid IP address data in 'Properties' at 'Ethernet address' in the area 'IP protocol'.
4. ➤ Enter at 'PROFINET' a 'PROFINET device name'. The device name must be unique at the Ethernet subnet.

Usage inverter drive via Modbus RTU > Usage in Siemens TIA Portal

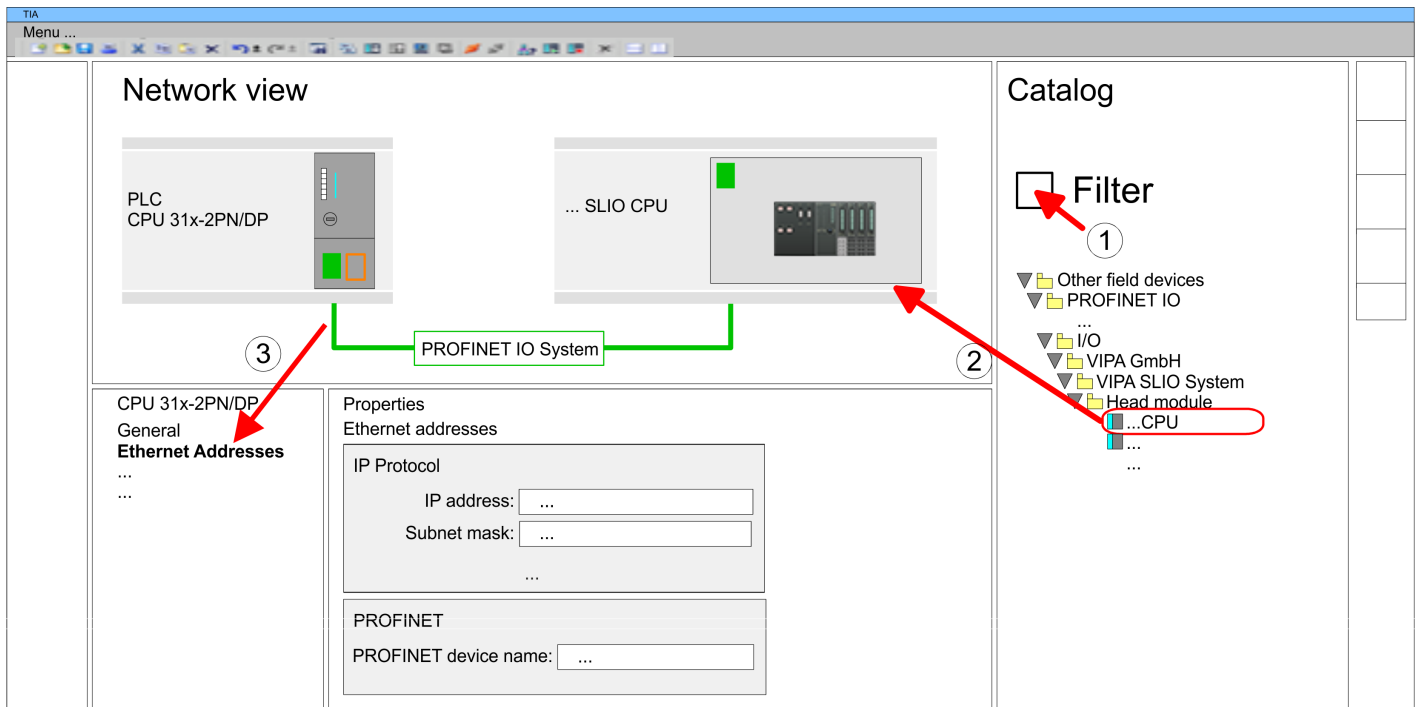

5. ➤ Select in the *Network view* the IO device 'VIPA SLIO CPU' and switch to the *Device overview*.
 ⇒ In the *Device overview* of the PROFINET IO device 'VIPA SLIO CPU' the CPU is already placed at slot 0.

Enable PtP functionality

For the System SLIO CPUs 014 ... 017, the RS485 interface is set to PtP communication as standard. A hardware configuration to enable the PtP functionality is not necessary.

Configuration of Ethernet PG/OP channel

1. ➤ As Ethernet PG/OP channel place at slot 4 the Siemens CP 343-1 (6GK7 343-1EX30 0XE0 V3.0).
2. ➤ Open the "Property" dialog by clicking on the CP 343-1EX30 and enter for the CP at "Properties" at "Ethernet address" the IP address data, which you have assigned before. You get valid IP address parameters from your system administrator.

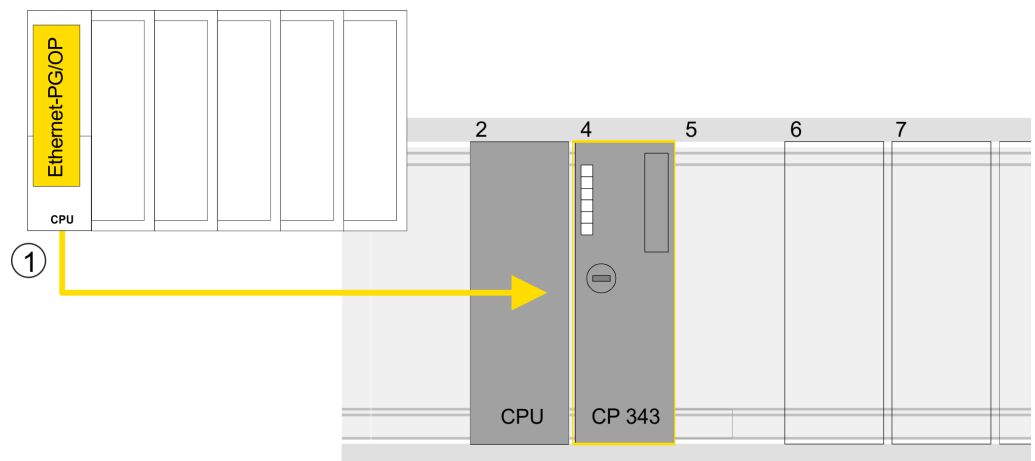

1 Ethernet PG/OP channel

Device overview

Module	...	Slot	...	Type	...
PLC ...		2		CPU 315-2 PN/DP	
MPI/DP interface		2 X1		MPI/DP interface	
PROFINET interface		2 X2		PROFINET interface	
...		
CP 343-1		4		CP 343-1	
...		

13.5.6.3 User program

13.5.6.3.1 Program structure

OB 100

FB 876 - VMC_ConfigMaster_RTU
SFC 216 - SER_CFG

- FB 876 - VMC_ConfigMaster_RTU ↗ 504
 - This block is used to parametrize the serial interface of the CPU for Modbus RTU communication.
 - Internally block SFC 216 - SER_CFG is called.

OB 1

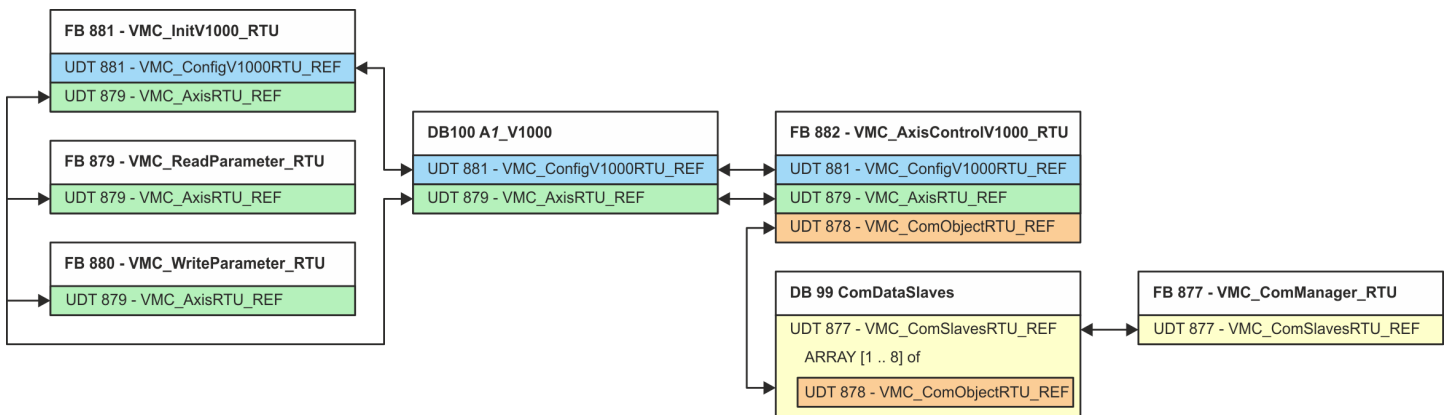

With the exception of blocks DB 99 and FB 877, you must create the blocks listed below for each connected inverter drive:

- FB 881 - VMC_InitV1000_RTU ↗ 507
 - The FB 881 - VMC_InitV1000_RTU initializes the corresponding inverter drive with the user data.
 - Before an inverter drive can be controlled, it must be initialized.
 - UDT 881 - VMC_ConfigV1000RTU_REF ↗ 504
 - UDT 879 - VMC_AxisRTU_REF ↗ 504
- FB 879 - VMC_ReadParameter_RTU ↗ 506
 - With this FB you have read access to the parameters of an inverter drive, which is connected serially via Modbus RTU.
 - The read data are recorded in a data block.
 - UDT 879 - VMC_AxisRTU_REF ↗ 504

- FB 880 - VMC_WriteParameter_RTU ↗ 507
 - With this FB you have read access to the parameters of an inverter drive, which is connected serially via Modbus RTU.
 - The data to be written must be stored in a data block.
 - UDT 879 - VMC_AxisRTU_REF ↗ 504
- DB 100 - A1_V1000
 - For each inverter drive, which is serially connected via Modbus RTU, a data block must be created.
 - UDT 879 - VMC_AxisRTU_REF ↗ 504
 - UDT 881 - VMC_ConfigV1000RTU_REF ↗ 504
- FB 882 - VMC_AxisControlV1000_RTU ↗ 509
 - With this block, you can control an inverter drive, which is serially connected via Modbus RTU and check its status.
 - UDT 881 - VMC_ConfigV1000RTU_REF ↗ 504
 - UDT 879 - VMC_AxisRTU_REF ↗ 504
 - UDT 878 - VMC_ComObjectRTU_REF ↗ 504
- DB 99 - ComDataSlaves
 - For the communication data of all the inverter drives (max. 8), which are serially connected via Modbus RTU, a common data block is to be created.
 - UDT 877 - VMC_ComSlavesRTU_REF ↗ 504
 - UDT 878 - VMC_ComObjectRTU_REF ↗ 504
- FB 877 - VMC_ComManager_RTU ↗ 505
 - The device ensures that only 1 inverter drive (Modbus slave) can use the serial interface. If several inverter drives are used, this block, as communication manager, sends the jobs to the respective Modbus slaves and evaluates their responses.
 - UDT 877 - VMC_ComSlavesRTU_REF ↗ 504

13.5.6.3.2 Copy blocks into project

Include library

1. ➤ Go to the service area of www.vipa.com.
2. ➤ Download the *Simple Motion Control* library from the download area at '*VIPA Lib*'.
The library is available as packed zip file for the corresponding TIA Portal version.
3. ➤ Start your un-zip application with a double click on the file ...TIA_Vxx.zip and copy all the files and folders in a work directory for the Siemens TIA Portal.
4. ➤ Switch to the *Project view* of the Siemens TIA Portal.
5. ➤ Choose "Libraries" from the task cards on the right side.
6. ➤ Click at "Global library".
7. ➤ Click on the free area inside the '*Global Library*' and select '*Context menu*
➔ *Retrieve library*'.
8. ➤ Navigate to your work directory and load the file ...Simple Motion.zalxx.

Copy blocks into project

➔ Copy all blocks from the library into the 'Program blocks' of the Project tree of your project.

- FB 876 - VMC_ConfigMaster_RTU
- FB 877 - VMC_ComManager_RTU
- FB 878 - VMC_RWParameterSys_RTU
- FB 879 - VMC_ReadParameter_RTU
- FB 880 - VMC_WriteParameter_RTU
- FB 881 - VMC_InitV1000_RTU
- FB 882 - VMC_AxisControlV1000_RTU
- FB 60 - SEND
- FB 61 - RECEIVE
- FB 72 - RTU MB_MASTER
- FC 216 - SER_CFG
- FC 217 - SER_SND
- FC 218 - SER_RCV
- UDT 877 - VMC_ComSlavesRTU_REF
- UDT 878 - VMC_ComObjectRTU_REF
- UDT 879 - VMC_AxisRTU_REF
- UDT 881 - VMC_ConfigV1000RTU_REF
- SFB 4 - TON

13.5.6.3.3 Create OB 100 for serial communication



1. ➔ Click at 'Project tree → ...CPU...PLC program → Program blocks → Add new block'.
⇒ The dialog 'Add block' is opened.
2. ➔ Enter OB 100 and confirm with [OK].
⇒ OB 100 is created and opened.
3. ➔ Add a Call FB876, DB876 to the OB 100.
⇒ The block call is created and a dialog opens to specify the instance data block 'VMC_ConfigMaster_RTU_876'.
4. ➔ Confirm the query of the instance data block with [OK].
5. ➔ Specify the following parameters:

Call FB876, DB876 ↪ Chap. 13.5.7.5 'FB 876 - VMC_ConfigMaster_RTU - Modbus RTU CPU interface' page 504

Baudrate	:= B#16#09	// Baud rate: 09h (9600bit/s)	IN: BYTE
CharLen	:= B#16#03	// Number data bits: 03h (8bit)	IN: BYTE
Parity	:= B#16#00	// Parity: 0 (none)	IN: BYTE
StopBits	:= B#16#01	// Stop bits: 1 (1bit)	IN: BYTE
TimeOut	:= W#16#1FFF	// Error wait time: 1FFFh (high selected)	IN: WORD
Valid	:= "ModbusConfigValid"	// Configuration	OUT BOOL
Error	:= "ModbusConfigError"	// Error feedback	OUT BOOL
ErrorID	:= "ModbusConfigErrorID"	// Additional error information	OUT: WORD



13.5.6.3.4 Create data block for Modbus slave

For each inverter drive, which is serially connected via Modbus RTU, a data block must be created.

1.  Click at 'Project tree → ...CPU...PLC program → Program blocks → Add new block'.
⇒ The dialog 'Add block' is opened.
2.  Select the block type 'DB block' and assign it the name "A1_V1000". The DB number can freely be selected such as DB100. Specify DB 100 and create this as a global DB with [OK].
⇒ The block is created and opened.
3.  In "A1_V1000" create the following variables:
 - 'AxisData' of type UDT 879 - VMC_AxisRTU_REF
 - 'V1000Data' of type UDT 881 - VMC_ConfigV1000RTU_REF





13.5.6.3.5 Create data block for all Modbus slaves

For the communication data of the inverter drives, which are serially connected via Modbus RTU, a common data block is to be created.

1.  Click at 'Project tree → ...CPU...PLC program → Program blocks → Add new block'.
⇒ The dialog 'Add block' is opened.
2.  Select the block type 'DB block' and assign it the name "ComDataSlaves". The DB number can freely be selected such as DB99. Specify DB 99 and create this as a global DB with [OK].
⇒ The block is created and opened.
3.  In "ComDataSlaves" create the following variable:
 - 'Slaves' of Type UDT 877 - VMC_ComSlavesRTU_REF

13.5.6.3.6 OB 1 - Create instance of communication manager

The FB 877 - VMC_ComManager_RTU ensures that only 1 inverter drive (Modbus slave) can use the serial interface. As a communication manager, the block sends the jobs to the respective Modbus slaves and evaluates their responses.

1.  Open the OB 1.
2.  Add a Call FB877, DB877 to OB 1.
⇒ The block call is created and a dialog opens to specify the instance data block 'VMC_ComManager_RTU_877'.
3.  Confirm the query of the instance data block with [OK].
4.  Specify the following parameters:

Call FB877, DB877  Chap. 13.5.7.6 'FB 877 - VMC_ComManager_RTU - Modbus RTU communication manager' page 505

NumberOfSlaves	:= 1	// Number of connected inverter drives: 1	IN: INT
WaitCycles	:= "ComWaitCycles"	// Minimum number of waiting cycles	IN: DINT
SlavesComData	:= "ComDataSlaves.Slave"	// Reference to all communication objects	IN-OUT: UDT 877

13.5.6.3.7 OB 1 - Create instance of the V1000 initialization

The FB 881 - VMC_InitV1000_RTU initializes the corresponding inverter drive with the user data. Before an inverter drive can be controlled, it must be initialized.

1. ➤ Add a Call FB881, DB881 to OB 1.
 - ⇒ The block call is created and a dialog opens to specify the instance data block 'VMC_InitV1000_RTU_881'.
2. ➤ Confirm the query of the instance data block with [OK].
3. ➤ Specify the following parameters:

Call FB881, DB881 ↪ *Chap. 13.5.7.10 'FB 881 - VMC_InitV1000_RTU - Modbus RTU initialization' page 507*

Execute	:= "A1_InitExecute"	// The job is started with edge 0-1.	IN: BOOL
Hardware	:= "A1_InitHardware"	// Specification of the hardware, used // 1: System SLIO CP040, 2: SPEED7 CPU	IN: BYTE
Laddr	:= "A1_InitLaddr"	// Logical address when using CP040	IN: INT
UnitId	:= "A1_InitUnitId"	// Modbus address of the V1000	IN: BYTE
UserUnitsVelocity	:= "A1_InitUserUnitsVel"	// User unit for velocities: // 0: Hz, 1: %, 2: RPM	IN: INT
UserUnitsAcceleration	:= "A1_InitUserUnitsAcc"	// User units acceleration/deceleration // 0: 0.01s, 1: 0.1s	IN: INT
MaxVelocityApp	:= "A1_InitMaxVelocityApp"	// Max. velocity in user units	IN: REAL
Done	:= "A1_InitDone"	// Status job finished	OUT: BOOL
Busy	:= "A1_InitBusy"	// Status job in progress	OUT: BOOL
Error	:= "A1_InitError"	// Error feedback	OUT: BOOL
ErrorID	:= "A1_InitErrorID"	// Additional error information	OUT: WORD
Axis	:= "A1_V1000".AxisData	// Reference to the general axis data	IN-OUT: UDT 879
V1000	:= "A1_V1000".V1000Data	// Reference to the drive-specific data	IN-OUT: UDT 881

Input values

All parameters must be interconnected with the corresponding variables or operands. The following input parameters must be pre-assigned:

- Hardware
 - Here specify the hardware you use to control your inverter drives:
 - 1: System SLIO CP040 whose logical address is to be specified via *Laddr*.
 - 2: SPEED7 CPU
- Laddr
 - Logical address for the System SLIO CP040 (*Hardware* = 1). Otherwise, this parameter is ignored.
- UnitId
 - Modbus address of the V1000.

- **UserUnitsVelocity**
User unit for speeds:
 - 0: Hz
Specified in hertz
 - 1: %
Specified as a percentage of the maximum speed
 $= 2 \cdot f_{\max} / P$
with f_{\max} : max. output frequency (parameter E1-04)
p: Number of motor poles (motor-dependent parameter E2-04, E4-04 or E5-04)
 - 2: RPM
Data in revolutions per minute
- **UserUnitsAcceleration**
User units for acceleration and deceleration
 - 0: 0.01s (range of values: 0.00s - 600.00s)
 - 1: 0.1s (range of values: 0.0 - 6000.0s)
- **MaxVelocityApp**
Max. speed for the application. The specification must be made in user units and is used for synchronization in movement commands.

13.5.6.3.8 OB 1 - Create instance axis control V1000

With the FB 882 - VMC_AxisControlV1000_RTU you can control an inverter drive, which is serially connected via Modbus RTU and check its status.

1. ➤ Add a Call FB882, DB882 to OB 1.
⇒ The block call is created and a dialog opens to specify the instance data block 'VMC_AxisControlV1000_RTU_882'.
2. ➤ Confirm the query of the instance data block with [OK].
3. ➤ Specify the following parameters:

Call FB882, DB882 ↪ *Chap. 13.5.7.11 'FB 882 - VMC_AxisControlV1000_RTU - Modbus RTU Axis control' page 509*

AxisEnable	:= "A1_AxisEnable"	// Activation of the axis	IN: BOOL
AxisReset	:= "A1_AxisReset"	// Command: Reset error of the V1000.	IN: BOOL
StopExecute	:= "A1_StopExecute"	// Command: Stop - Stop axis	IN: BOOL
MvVelocityExecute	:= "A1_MvVelocityExecute"	// Command: MoveVelocity (velocity control)	IN: BOOL
Velocity	:= "A1_Velocity"	// Parameter: Velocity setting for MoveVelocity	IN: REAL
AccelerationTime	:= "A1_AccelerationTime"	// Parameter: Acceleration time	IN: REAL
DecelerationTime	:= "A1_DecelerationTime"	// Parameter: Deceleration time	IN: REAL
JogPositive	:= "A1_JogPositive"	// Command: JogPos	IN: BOOL
JogNegative	:= "A1_JogNegative"	// Command: JogNeg	IN: BOOL
JogVelocity	:= "A1_JogVelocity"	// Parameter: Velocity setting for jogging	IN: REAL
JogAccelerationTime	:= "A1_JogAccelerationTime"	// Parameter: Acceleration time for jogging	IN: REAL
JogDecelerationTime	:= "A1_JogDecelerationTime"	// Parameter: Deceleration time for jogging	IN: REAL
AxisReady	:= "A1_AxisReady"	// Status: Axis ready	OUT: BOOL
AxisEnabled	:= "A1_AxisEnabled"	// Status: Activation of the axis	OUT: BOOL
AxisError	:= "A1_AxisError"	// Status: Axis error	OUT: BOOL

Usage inverter drive via Modbus RTU > Usage in Siemens TIA Portal

AxisErrorID	:= "A1_AxisErrorID"	// Status: Additional error information for <i>AxisError</i>	OUT: WORD
DriveError	:= "A1_DriveError"	// Status: Error on the inverter drive	OUT: BOOL
ActualVelocity	:= "A1_ActualVelocity"	// Status: Current velocity	OUT: REAL
InVelocity	:= "A1_InVelocity"	// Status target velocity	OUT: BOOL
CmdDone	:= "A1_CmdDone"	// Status: Command finished	OUT: BOOL
CmdBusy	:= "A1_CmdBusy"	// Status: Command in progress	OUT: BOOL
CmdAborted	:= "A1_CmdAborted"	// Status: Command aborted	OUT: BOOL
CmdError	:= "A1_CmdError"	// Status: Command error	OUT: BOOL
CmdErrorID	:= "A1_CmdErrorID"	// Status: Additional error information for <i>CmdError</i>	OUT: WORD
CmdActive	:= "A1_CmdActive"	// Status: Active command	OUT: INT
DirectionPositive	:= "A1_DirectionPositive"	// Status: Direction of rotation positive	OUT: BOOL
DirectionNegative	:= "A1_DirectionNegative"	// Status: Direction of rotation negative	OUT: BOOL
Axis	:= "A1_V1000".AxisData	// Reference to the general axis data	IN-OUT: UDT 879
V1000	:= "A1_V1000".V1000Data	// Reference to the general axis data // of the inverter drive	IN-OUT: UDT 881
AxisComData	:= "ComDataSlaves".Slaves.Slave(1)	// Reference to the communication data	IN-OUT: UDT 878

13.5.6.3.9 OB 1 - Create instance read parameter

With the FB 879 - VMC_ReadParameter_RTU you have read access to the parameters of an inverter drive, which is serially connected via Modbus RTU. For the parameter data a DB is to be created.

1. Click at *'Project tree → ...CPU...PLC program → Program blocks → Add new block'*.
⇒ The dialog *'Add block'* is opened.
2. Select the block type *'DB block'* and assign it the name "A1_TransferData". The DB number can freely be selected. Specify DB 98 and create this as a global DB with [OK].
⇒ The block is created and opened.
3. In "A1_TransferData" create the following variables:
 - *'Data_0'* of type WORD
 - *'Data_1'* of type WORD
 - *'Data_2'* of type WORD
 - *'Data_3'* of type WORD
4. Add a Call FB879, DB879 to OB 1.
⇒ The block call is created and a dialog opens to specify the instance data block *'VMC_ReadParameter_RTU'*.
5. Confirm the query of the instance data block with [OK].
6. Specify the following parameters:

Call FB879, DB879 ↪ *Chap. 13.5.7.8 'FB 879 - VMC_ReadParameter_RTU - Modbus RTU read parameters' page 506*

Execute	:= "A1_RdParExecute"	// The job is started with edge 0-1.	IN: BOOL
StartAddress	:= "A1_RdParStartAddress"	// Start address of the 1. register	IN: INT

Usage inverter drive via Modbus RTU > Usage in Siemens TIA Portal

Quantity	:= "A1_RdParQuantity"	// Number of registers to read	IN: INT
Done	:= "A1_RdParDone"	// Status job finished	IN: REAL
Busy	:= "A1_RdParBusy"	// Status job in progress	OUT: BOOL
Error	:= "A1_RdParError"	// Error feedback	OUT: BOOL
ErrorID	:= "A1_RdParErrorID"	// Additional error information	OUT: BOOL
Data	:= P#DB98.DBX0.0 BYTES 8	// Location of the parameter data	OUT: WORD
Axis	:= "A1_V1000".AxisData	// Reference to the general axis data	IN-OUT: UDT 879



Please note that only whole registers can be read as WORD. To evaluate individual bits, you must swap high and low byte!

13.5.6.3.10 OB 1 - Create instance write parameter

With the FB 880 - VMC_WriteParameter_RTU you have write access to the parameters of an inverter drive, which is serially connected via Modbus RTU. For the data you can use the DB created for read access - here DB 98.

1. ➔ Add a Call FB880, DB880 to OB 1.

⇒ The block call is created and a dialog opens to specify the instance data block 'VMC_WriteParameter_RTU'.



2. ➔ Confirm the query of the instance data block with [OK].

3. ➔ Specify the following parameters:

Call FB880, DB880 ↪ *Chap. 13.5.7.9 'FB 880 - VMC_WriteParameter_RTU - Modbus RTU write parameters' page 507*



Execute	:= "A1_WrParExecute"	// The job is started with edge 0-1.	IN: BOOL
StartAddress	:= "A1_WrParStartAddress"	// Start address of the 1. register	IN: INT
Quantity	:= "A1_WrParQuantity"	// Number of registers to write	IN: INT
Done	:= "A1_WrParDone"	// Status job finished	IN: REAL
Busy	:= "A1_WrParBusy"	// Status job in progress	OUT: BOOL
Error	:= "A1_WrParError"	// Error feedback	OUT: BOOL
ErrorID	:= "A1_WrParErrorID"	// Additional error information	OUT: BOOL
Data	:= P#DB98.DBX0.0 BYTES 8	// Location of the parameter data	OUT: WORD
Axis	:= "A1_V1000".AxisData	// Reference to the general axis data	IN-OUT: UDT 879

13.5.6.3.11 Sequence of operations

1.  Safe and translate your project.
2.  Transfer your project to your CPU.
 - ⇒ You can take your application into operation now.

**CAUTION!**

Please always observe the safety instructions for your inverter drive, especially during commissioning!

3.  A watch table allows you to manually control the inverter drive. To create a watch table, double-click 'Project tree → ...CPU... → Watch and force tables → Add new watch table'.
 - ⇒ The watch table is created and opened for editing.
4.  First adjust the waiting time between 2 jobs. This is at least 200ms for a V1000 inverter drive. For this enter in the watch table at 'Name' the designation 'ComWaitCycles' as 'DEC' and enter at 'Modify value' a value between 200 and 400.



To increase performance, you can later correct this to a smaller value as long as you do not receive a timeout error (80C8h). Please note that some commands, such as MoveVelocity, can consist of several jobs.





5.  Before you can control an inverter drive, it must be initialized with FB 881 - VMC_InitV1000_RTU. [↪ Chap. 13.5.7.10 'FB 881 - VMC_InitV1000_RTU - Modbus RTU initialization' page 507](#)

For this enter in the watch table at 'Name' the designation 'A1_InitExecute' as 'Boolean' and enter at 'Modify value' the value 'True'. Activate the modification of the variables and start the transmission of the modified values.

- ⇒ The inverter drive is initialized. After execution, the output *Done* returns TRUE. In the event of a fault, you can determine the error by evaluating the *ErrorID*.



Do not continue as long as the Init block reports any errors!

6.  After successful initialization, the registers of the connected inverter drives are cyclically processed, i.e. they receive cyclical jobs. For manual control, you can use the FB 882 - VMC_AxisControlV1000_RTU to send control commands to the appropriate inverter drive. [↪ Chap. 13.5.7.11 'FB 882 - VMC_AxisControlV1000_RTU - Modbus RTU Axis control' page 509](#)
7.  Create the parameters of the FB 882 - VMC_AxisControlV1000_RTU for control and query in the watch table.
8.  Save the watch table under a name such as 'V1000'.
9.  Activate the corresponding axis by setting *AxisEnable*. As soon as this reports *Axis-Ready* = TRUE, you can control it with the corresponding drive commands.

13.5.7 Drive specific blocks

13.5.7.1 UDT 877 - VMC_ComSlavesRTU_REF - Modbus RTU data structure communication data all slaves

This is a user-defined data structure for the communication data of the connected Modbus RTU slaves. The UDT is specially adapted to the use of inverter drives, which are connected via Modbus RTU.

13.5.7.2 UDT 878 - VMC_ComObjectRTU_REF - Modbus RTU data structure communication data slave

This is a user-defined data structure for the communication data of a connected Modbus RTU slave. The UDT is specially adapted to the use of inverter drives, which are connected via Modbus RTU.

13.5.7.3 UDT 879 - VMC_AxisRTU_REF - Modbus RTU data structure axis data

This is a user-defined data structure that contains status information about the inverter drive. This structure serves as a reference to the general axis data of the inverter drive.

13.5.7.4 UDT 881 - VMC_ConfigV1000RTU_REF - Modbus RTU data structure configuration

This is a user-defined data structure containing information about the configuration data of an inverter drive, which is connected via Modbus RTU.

13.5.7.5 FB 876 - VMC_ConfigMaster_RTU - Modbus RTU CPU interface

Description

This block is used to parametrize the serial interface of the CPU for Modbus RTU communication.



Please note that this block internally calls the SFC 216.

In the SPEED7 Studio, this module is automatically inserted into your project.

In Siemens SIMATIC Manager, you have to copy the SFC 216 from the Motion Control Library into your project.

Parameter

Parameter	Declaration	Data type	Description
Baudrate	IN	BYTE	Speed of data transmission in bit/s (baud). <ul style="list-style-type: none"> ■ 04h: 1200baud ■ 05h: 1800baud ■ 06h: 2400baud ■ 07h: 4800baud ■ 08h: 7200baud ■ 09h: 9600baud ■ 0Ah: 14400baud ■ 0Bh: 19200baud ■ 0Ch: 38400baud ■ 0Dh: 57600baud ■ 0Eh: 115200baud

Parameter	Declaration	Data type	Description
CharLen	IN	BYTE	Number of data bits to which a character is mapped <ul style="list-style-type: none"> 0: 5bit 1: 6bit 2: 7bit 3: 8bit
Parity	IN	BYTE	The parity is even or odd depending on the value. For parity control, the information bits are extended by the parity bit, which by its value ("0" or "1") adds the value of all bits to an agreed state. If no parity is specified, the parity bit is set to "1" but not evaluated. <ul style="list-style-type: none"> 0: None 1: Odd 2: Even
StopBits	IN	BYTE	The stop bits are added to each character to be transmitted and signalize the end of a character <ul style="list-style-type: none"> 1: 1bit 2: 1.5bit 3: 2bit
TimeOut	IN	WORD	Waiting time until an error is generated if a slave does not respond. The time for <i>TimeOut</i> must be specified as a hexadecimal value. The hexadecimal value is obtained by multiplying the desired time in seconds by the baud rate. Example: Desired time 8ms at a baud rate of 19200bit/s Calculation: $19200\text{bit/s} \times 0.008\text{s} \approx 154\text{bit} \gggg (9Ah)$ The hex value should be 9Ah.
Valid	OUT	BOOL	Configuration <ul style="list-style-type: none"> TRUE: The configuration is valid. FALSE: The configuration is not valid.
Error	OUT	BOOL	Error feedback <ul style="list-style-type: none"> TRUE: An error has occurred - see <i>ErrorID</i>. FALSE: There is no error.
ErrorID	OUTPUT	WORD	Additional error information ↗ Chap. 13.10 'ErrorID - Additional error information' page 637

13.5.7.6 FB 877 - VMC_ComManager_RTU - Modbus RTU communication manager

Description

This block regulates that only one slave can communicate in succession via the serial interface. Via the UDT 877 this block has access to the communication data of all slaves.



You can only use one FB 877 in your project per serial interface!

Parameter

Parameter	Declaration	Data type	Description
NumberOfSlaves	IN	INT	Number of currently used Modbus slaves
WaitCycles	IN	DINT	Minimum number of cycles to wait between two requests from a slave. This prevents overflows on the slave and resulting timeouts.
SlavesComData	IN-OUT	UDT 877	Reference to the data block with all communication objects

13.5.7.7 FB 878 - VMC_RWParameterSys_RTU - Modbus RTU read/write parameters system**Description**

This block is used internally by the system for parameter transfer.



You must not call this module, as this can lead to a malfunction of your system!

13.5.7.8 FB 879 - VMC_ReadParameter_RTU - Modbus RTU read parameters**Description**

With this block you can read parameters from the corresponding slave.



Please note that only whole registers can be read as WORD. To evaluate individual bits, you must swap high and low byte!

Parameter

Parameter	Declaration	Data type	Description
Execute	IN	BOOL	The job is started with edge 0-1.
StartAddress	IN	WORD	Start address of the register from which to read.
Quantity	IN	BYTE	Number of registers to read.
Done	OUT	BOOL	Status <ul style="list-style-type: none"> ■ TRUE: Job successfully done
Busy	OUT	BOOL	Status <ul style="list-style-type: none"> ■ TRUE: Job is running
Error	OUT	BOOL	Status <ul style="list-style-type: none"> ■ TRUE: An error has occurred. Additional error information can be found in the parameter <i>ErrorID</i>.
ErrorID	OUT	WORD	Additional error information <ul style="list-style-type: none"> 🔗 <i>Chap. 13.10 'ErrorID - Additional error information' page 637</i>
Data	IN-OUT	ANY	Reference where to store the read data
Axis	IN-OUT	UDT 879	Reference to the general axis data of the inverter drive

13.5.7.9 FB 880 - VMC_WriteParameter_RTU - Modbus RTU write parameters

Description

With this block you can write parameters in the registers of the corresponding slave.



Please note that only whole registers can be written as WORD. To set or reset individual bits, you must swap high and low byte!

Parameter

Parameter	Declaration	Data type	Description
Execute	IN	BOOL	The job is started with edge 0-1.
StartAddress	IN	WORD	Start address of the register from which to write.
Quantity	IN	BYTE	Number of registers to write.
Done	OUT	BOOL	Status <ul style="list-style-type: none"> ■ TRUE: Job successfully done
Busy	OUT	BOOL	Status <ul style="list-style-type: none"> ■ TRUE: Job is running
Error	OUT	BOOL	Status <ul style="list-style-type: none"> ■ TRUE: An error has occurred. Additional error information can be found in the parameter <i>ErrorID</i>.
ErrorID	OUT	WORD	Additional error information <ul style="list-style-type: none"> 🔗 <i>Chap. 13.10 'ErrorID - Additional error information' page 637</i>
Data	IN-OUT	ANY	Reference to the data to be written.
Axis	IN-OUT	UDT 879	Reference to the general axis data of the inverter drive

13.5.7.10 FB 881 - VMC_InitV1000_RTU - Modbus RTU initialization

Description

This block is used to initialize the corresponding inverter drive with the user data and must be processed, before commands can be transferred. The block is specially adapted to the use of a inverter drive, which is connected via Modbus RTU.

Parameter

Parameter	Declaration	Data type	Description
Execute	IN	BOOL	The job is started with edge 0-1.
Hardware	IN	BYTE	Specification of the hardware, which is used <ul style="list-style-type: none"> ■ 1: System SLIO CP040 whose logical address is to be specified via <i>Laddr</i>. ■ 2: SPEED7 CPU
Laddr	IN	INT	Logical address for the System SLIO CP040 (<i>Hardware</i> = 1). Otherwise, this parameter is ignored.
UnitId	IN	BYTE	Modbus address of the V1000.

Usage inverter drive via Modbus RTU > Drive specific blocks

Parameter	Declaration	Data type	Description
UserUnitsVelocity	IN	INT	User unit for speeds <ul style="list-style-type: none"> ■ 0: Hz <ul style="list-style-type: none"> – Specified in hertz ■ 1: % <ul style="list-style-type: none"> – Specified as a percentage of the maximum speed – $= 2 \cdot f_{\max} / p$ with f_{\max}: max. output frequency (parameter E1-04) p: Number of motor poles (motor-dependent parameter E2-04, E4-04 or E5-04) ■ 2: RPM <ul style="list-style-type: none"> – Data in revolutions per minute
UserUnitsAcceleration	IN	INT	User units for acceleration and deceleration <ul style="list-style-type: none"> ■ 0: 0.01s (range of values: 0.00s - 600.00s) ■ 1: 0.1s (range of values: 0.0 - 6000.0s)
MaxVelocityApp	IN	REAL	Max. speed for the application. The specification must be made in user units and is used for synchronization in movement commands.
Done	OUT	BOOL	Status <ul style="list-style-type: none"> ■ TRUE: Job successfully done
Busy	OUT	BOOL	Status <ul style="list-style-type: none"> ■ TRUE: Job is running
Error	OUT	BOOL	Status <ul style="list-style-type: none"> ■ TRUE: An error has occurred. Additional error information can be found in the parameter <i>ErrorID</i>.
ErrorID	OUT	WORD	Additional error information ↗ Chap. 13.10 'ErrorID - Additional error information' page 637
Axis	IN-OUT	UDT 879	Reference to the general axis data of the inverter drive
V1000	IN-OUT	UDT 881	Reference to the user data of the inverter drive

13.5.7.11 FB 882 - VMC_AxisControlV1000_RTU - Modbus RTU Axis control

Description

With the FB 882 *VMC_AxisControlV1000_RTU* you can control an inverter drive, which is serially connected via Modbus RTU and check its status.



The control of a V1000 inverter drive, which is connected via Modbus RTU, takes place exclusively with FB 882 VMC_AxisControlV1000_RTU. PLCOpen blocks are not supported!

Parameter

Parameter	Declaration	Data type	Description
AxisEnable	IN	BOOL	Activation of the axis <ul style="list-style-type: none"> ■ TRUE: Switch on axis → <i>AxisEnabled</i> = 1, commands can be executed. ■ FALSE: Switch off the axis → <i>AxisEnabled</i> = 0, no commands can be executed.
AxisReset	IN	BOOL	Command: Reset inverter drive faults. → <i>CmdActive</i> = 1
StopExecute	IN	BOOL	Command: <i>Stop</i> - Stop axis → <i>CmdActive</i> = 1
MvVelocityExecute	IN	BOOL	Command: <i>MoveVelocity</i> (velocity control) → <i>CmdActive</i> = 2
Velocity	IN	REAL	Parameter: Velocity setting for <i>MoveVelocity</i> in user units. See example below the table
AccelerationTime	IN	REAL	Parameter: Acceleration time in seconds (accuracy depending on <i>UserUnitsAcceleration</i> at Init block). Always related to time, from standstill to the maximum set velocity. See example below the table
DecelerationTime	IN	REAL	Parameter: Deceleration time in seconds (accuracy depending on <i>UserUnitsAcceleration</i> at Init block). Always related to time, from standstill to the maximum set velocity. See example below
JogPositive	IN	BOOL	Command: <i>JogPos</i> <ul style="list-style-type: none"> ■ Edge 0-1: Start axis in positive direction (jogging positive) ■ Edge 1-0: Stop axis
JogNegative	IN	BOOL	Command: <i>JogNeg</i> <ul style="list-style-type: none"> ■ Edge 0-1: Start axis in negative direction (jogging negative) ■ Edge 1-0: Stop axis
JogVelocity	IN	REAL	Parameter: Velocity setting for jogging in user units. See example below
JogAccelerationTime	IN	REAL	Parameter: Acceleration time for jogging in seconds (accuracy depending on <i>UserUnitsAcceleration</i> at Init block). Is always based on the time, from standstill to the maximum set speed. See example below the table
JogDecelerationTime	IN	REAL	Parameter: Deceleration time for jogging in seconds (accuracy depending on <i>UserUnitsAcceleration</i> of FB 881). Parameter always refers to the time from standstill to the maximum set velocity. See example below the table

Usage inverter drive via Modbus RTU > Drive specific blocks

Parameter	Declaration	Data type	Description
AxisReady	OUT	BOOL	Status: Axis ready <ul style="list-style-type: none"> ■ TRUE: The axis is ready to switch on. ■ FALSE: The axis is not ready to switch on.
AxisEnabled	OUT	BOOL	Status: Activation of the axis <ul style="list-style-type: none"> ■ TRUE: The axis is switched on ■ FALSE: The axis is switched off
AxisError	OUT	BOOL	Status: Axis error <ul style="list-style-type: none"> ■ TRUE: Axis reports an error and is locked. Further error information can be found in <i>AxisErrorID</i>. ■ FALSE: Axis does not report any errors.
AxisErrorID	OUT	WORD	Status: Additional error information for <i>AxisError</i> ↗ Chap. 13.10 'ErrorID - Additional error information' page 637
DriveError	OUT	BOOL	Status: Error on the inverter drive <ul style="list-style-type: none"> ■ TRUE: Inverter drive reports an error and is locked. ■ FALSE: Inverter drive does not report any errors.
ActualVelocity	OUT	REAL	Status: Current velocity in user units
InVelocity	OUT	BOOL	Status target velocity <ul style="list-style-type: none"> ■ TRUE: The target velocity <i>Velocity</i> has been reached. ■ FALSE: The target velocity <i>Velocity</i> has not yet been reached.
CmdDone	OUT	BOOL	Status: Command finished <ul style="list-style-type: none"> ■ TRUE: Command was executed successfully. ■ FALSE: Command has not yet been executed or is still in progress.
CmdBusy	OUT	BOOL	Status: Command in progress <ul style="list-style-type: none"> ■ TRUE: Command is in progress ■ FALSE: Currently no command is executed.
CmdAborted	OUT	BOOL	Status: Command aborted <ul style="list-style-type: none"> ■ TRUE: Command was aborted ■ FALSE: Command was not aborted
CmdError	OUT	BOOL	Status: Command error <ul style="list-style-type: none"> ■ TRUE: An error occurred while executing a command ■ FALSE: The execution of a command proceeded correctly.
CmdErrorID	OUT	WORD	Status: Additional error information for <i>CmdError</i> ↗ Chap. 13.10 'ErrorID - Additional error information' page 637
CmdActive	OUT	INT	Status: Active command <ul style="list-style-type: none"> ■ 0: NoCmd - no command active ■ 1: Stop ■ 2: MvVelocity ■ 3: MvRelative ■ 4: JogPos ■ 5: JogNeg

Parameter	Declaration	Data type	Description
DirectionPositive	OUT	BOOL	Status: Direction of rotation positive <ul style="list-style-type: none"> ■ TRUE: Current direction of rotation is positive ■ FALSE: Current direction of rotation is not positive
DirectionNegative	OUT	BOOL	Status: Direction of rotation negative <ul style="list-style-type: none"> ■ TRUE: Current direction of rotation is negative ■ FALSE: Current direction of rotation is not negative
Axis	IN-OUT	UDT 879	Reference to the general axis data of the inverter drive
V1000	IN-OUT	UDT 881	Reference to the user data of the inverter drive
AxisComData	IN-OUT	UDT 878	Reference to the communication data of the current slave

Example AccelerationTime The values for *Velocity*, *AccelerationTime* and *DecelerationTime* must be specified in the user units of the FB 881 - VMC_InitV1000_RTU. *AccelerationTime* or *DecelerationTime* always refer to the time from standstill to the maximum set velocity or from the maximum velocity to standstill.

The maximum velocity results from the formula

$$v_{max} = \frac{2 \cdot f}{p}$$

v_{max} max. velocity in 1/s

f max. Output frequency (parameter E1-04)

p Number of motor poles (motor-dependent parameter E2-04, E4-04 or E5-04)

Sequence of operations

1. ➤ Select 'Project → Compile all' and transfer the project into your CPU. You can find more information on the transfer of your project in the online help of the *SPEED7 Studio*.

⇒ You can take your application into operation now.



CAUTION!

Please always observe the safety instructions for your inverter drive, especially during commissioning!

2. ➤ Bring your CPU into RUN and turn on your inverter drive.

⇒ The FB 882 - VMC_AxisControlV1000_RTU is executed cyclically.

3. ➤ As soon as *AxisReady* = TRUE, you can use *AxisEnable* to enable the axis.

4. ➤ You now have the possibility to control your drive via its parameters and to check its status.

13.6 Usage inverter drive via EtherCAT

13.6.1 Overview

Precondition

- SPEED7 Studio from V1.8
or
- Siemens SIMATIC Manager from V 5.5, SP2 & *SPEED7 EtherCAT Manager & Simple Motion Control Library*

Usage inverter drive via EtherCAT > Set the parameters on the inverter drive

- CPU with EtherCAT master, such as CPU 015-CEFNR00
- Inverter drive with EtherCAT option card

Steps of configuration

1. ➤ Set the parameters on the inverter drive.
 - The setting of the parameters happens by means of the software tool *Drive Wizard+*.
2. ➤ Hardware configuration in the VIPA *SPEED7 Studio* or Siemens SIMATIC Manager.
 - Configuring the CPU.
3. ➤ Programming in the VIPA *SPEED7 Studio* or Siemens SIMATIC Manager.
 - *Init* block for the configuration of the axis.
 - *Kernel* block for communication with the axis.
 - Connecting the blocks for motion sequences.

13.6.2 Set the parameters on the inverter drive



CAUTION!

Before the commissioning, you have to adapt your inverter drive to your application with the *Drive Wizard+* software tool! More may be found in the manual of your inverter drive.

The following table shows all parameters which do not correspond to the default values. The following parameters must be set via *Drive Wizard+* to match the *Simple Motion Control Library*.

No.	Designation	Range of values	Setting for <i>Simple Motion Control Library</i>
B1-01	Input source frequency setpoint 1	0, 1, 2, 3, 4	■ 3: Option card
B1-02	Input source start command 1	0, 1, 2, 3	■ 3: Option card
O1-03	Display scaling	0, 1, 2, 3, 4	■ 2: min-1 unit



For all settings to be accepted, you must restart the inverter drive after parametrization!

13.6.3 Wiring

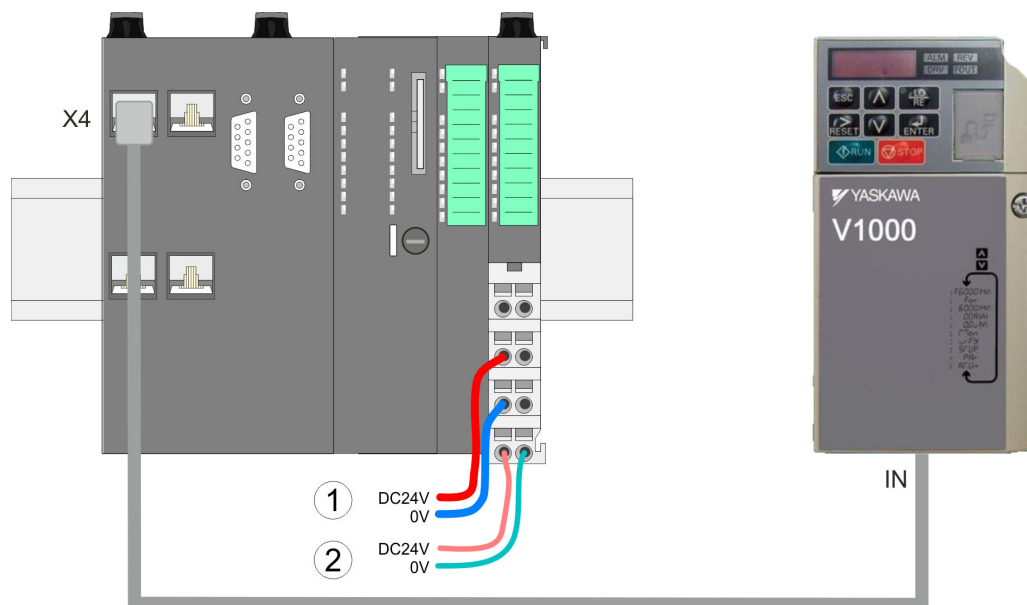

(1) DC 24V for power section supply I/O area (max. 10A)

(2) DC 24V for electronic power supply CPU and I/O area

Proceeding

1. Turn off power supply of the CPU and the inverter drive.
2. If not already installed, install the EtherCAT option card in your inverter drive.
3. Connect the option card and the inverter drive via the enclosed ground cable.
4. Connect the EtherCAT jack 'X4' of the CPU to the 'IN' jack of the option card via an EtherCAT cable.
 - ⇒ Your system is now ready for commissioning.

13.6.4 Usage in VIPA *SPEED7 Studio*

13.6.4.1 Hardware configuration

Add CPU in the project

Please use the *SPEED7 Studio* V1.8 and up for the configuration.

1. Start the *SPEED7 Studio*.

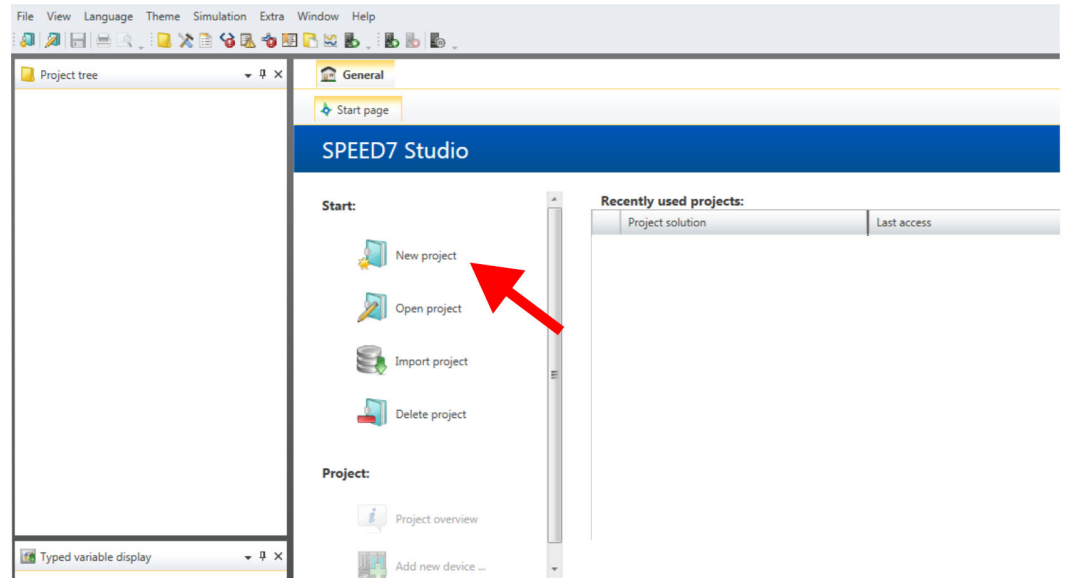

2. Create a new project at the start page with 'New project' and assign a 'Project name'.

⇒ A new project is created and the view 'Devices and networking' is shown.

3. Click in the *Project tree* at 'Add new device ...'.

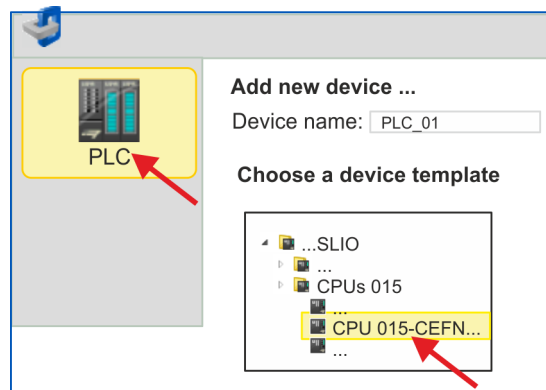
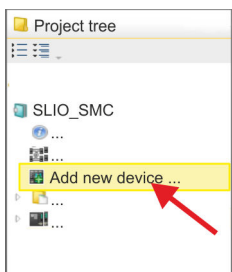

⇒ A dialog for device selection opens.

4. Select from the 'Device templates' a CPU with EtherCAT master functionality such as the CPU 015-CEFNR00 and click at [OK].

⇒ The CPU is inserted in 'Devices and networking' and the 'Device configuration' is opened.

Activate motion control functions

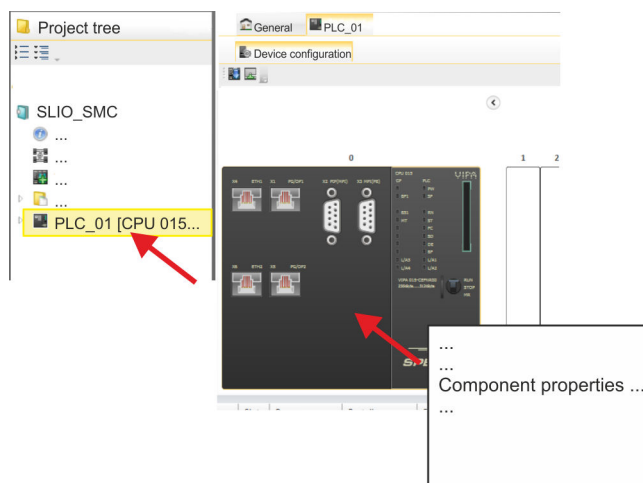

1. Click at the CPU in the 'Device configuration' and select 'Context menu' → 'Components properties'.

⇒ The properties dialog of the CPU is opened.

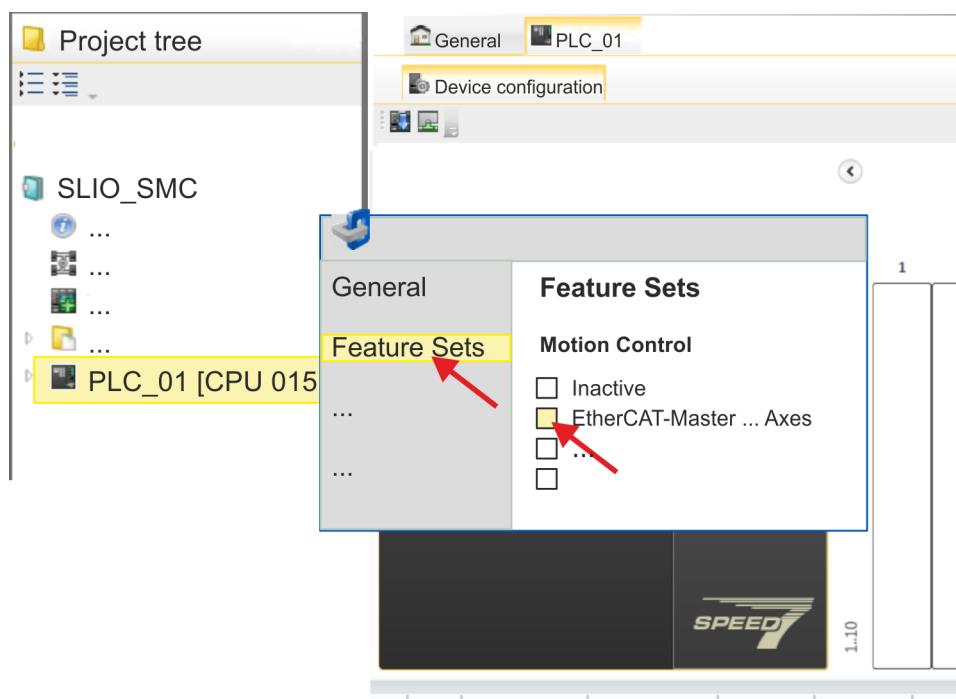

2. Click at 'Feature Sets' and activate at 'Motion Control' the parameter 'EtherCAT-Master... Axes'. The number of axes is not relevant in this example.

3. Confirm your input with [OK].

⇒ The motion control functions are now available in your project.



CAUTION!

Please note due to the system, with every change to the feature set settings, the EtherCAT field bus system and its motion control configuration will be deleted from your project!

Configuration of Ethernet PG/OP channel

1. Click in the *Project tree* at *'Devices and networking'*.
⇒ You will get a graphical object view of your CPU.

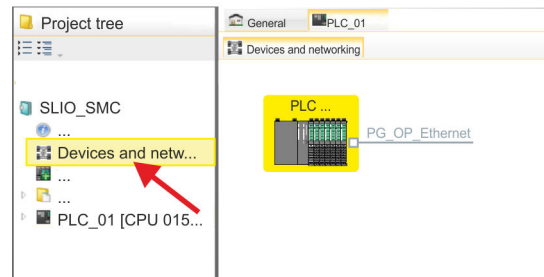

2. Click at the network *'PG_OP_Ethernet'*.
3. Select *'Context menu → Interface properties'*.
⇒ A dialog window opens. Here you can enter the IP address data for your Ethernet PG/OP channel. You get valid IP address parameters from your system administrator.
4. Confirm with [OK].
⇒ The IP address data are stored in your project listed in *'Devices and networking'* at *'Local components'*.
After transferring your project your CPU can be accessed via Ethernet PG/OP channel with the set IP address data.

Installing the ESI file

For the inverter drive can be configured in the *SPEED7 EtherCAT Manager*, the corresponding ESI file must be installed. Usually, the *SPEED7 Studio* is delivered with current ESI files and you can skip this part. If your ESI file is not up-to date, you will find the latest ESI file for the inverter drive under www.yaskawa.eu.com at *'Service → Drives & Motion Software'*.

1. Download the according ESI file for your inverter drive. Unzip this if necessary.
2. Navigate to your *SPEED7 Studio*.
3. Open the corresponding dialog window by clicking on *'Extra → Install device description (EtherCAT - ESI)'*.
4. Under *'Source path'*, specify the ESI file and install it with [Install].
⇒ The devices of the ESI file are now available.

Add an inverter drive

1. Click in the Project tree at *'Devices and networking'*.
2. Click here at *'EC-Mastersystem'* and select *'Context menu → Add new device'*.

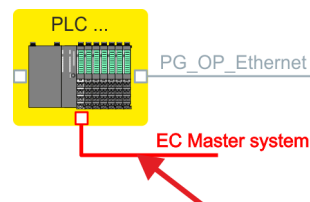

- ⇒ The device template for selecting an EtherCAT device opens.

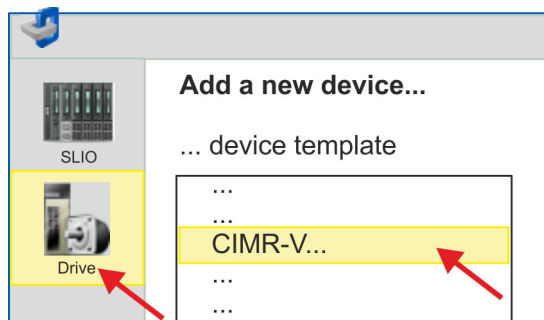

3. Select your inverter drive:

- CIMR-Vxxxx...
- CIPR-GA70xxxx...

Confirm with [OK]. If your drive does not exist, you must install the corresponding ESI file as described above.

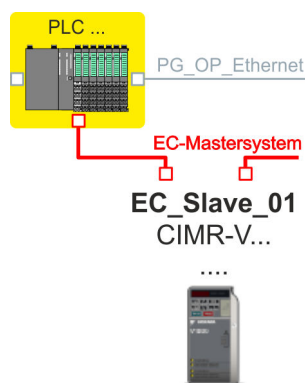

⇒ The inverter drive is connected to your EC-Mastersystem.

Configure inverter drive

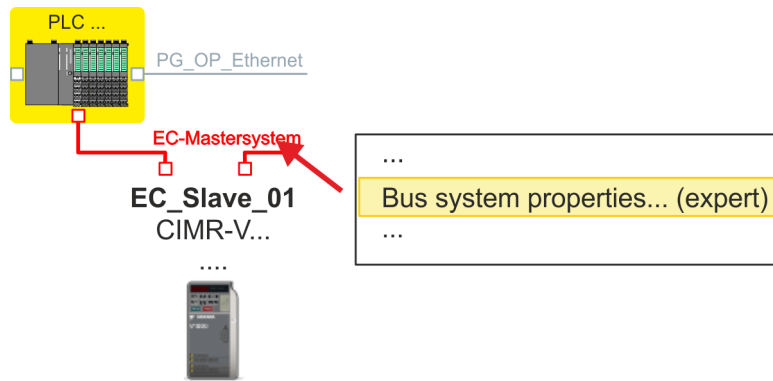

1. Click here at 'EC-Mastersystem' and select 'Context menu' → 'Bus system properties (expert)'.

i You can only edit PDOs in 'Expert mode'! Otherwise, the buttons are hidden.

⇒ The *SPEED7 EtherCAT Manager* opens. Here you can configure the EtherCAT communication to your inverter drive.

More information about the usage of the *SPEED7 EtherCAT Manager* may be found in the online help of the *SPEED7 Studio*.

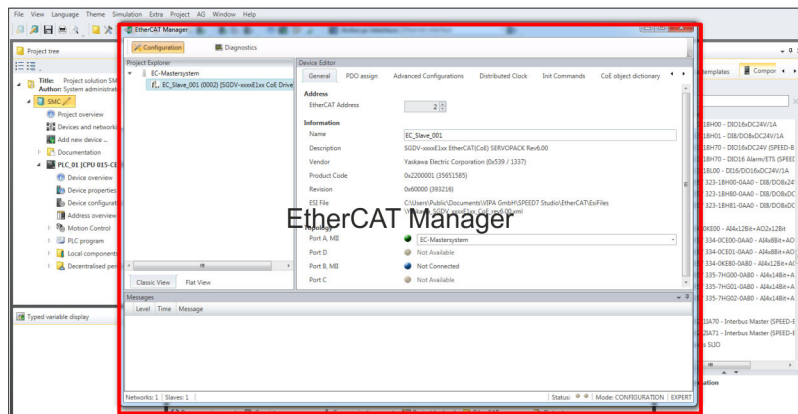

2. Click on the slave in the *SPEED7 EtherCAT Manager* and select the 'PDO assign' tab in the 'Device editor'.

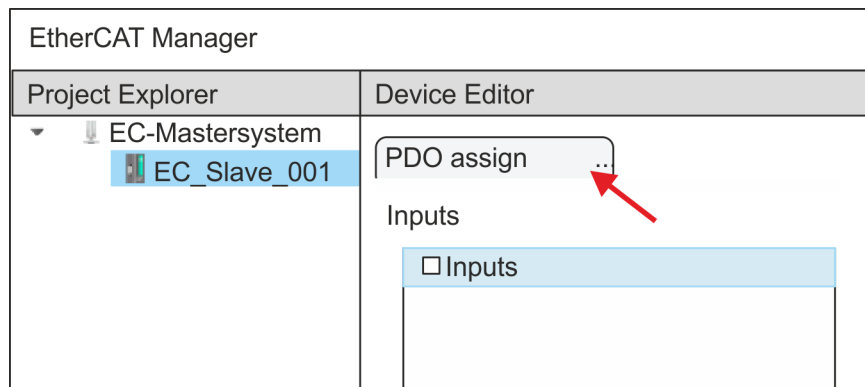

⇒ This dialog shows a list of the PDOs.

3. ➔ By selecting the appropriate mapping, you can edit the PDOs with [Edit]. Select the mapping 'Inputs' and click at [Edit].



Please note that some PDOs can not be edited because of the default settings. By de-activating already activated PDOs, you can release the processing of locked PDOs.

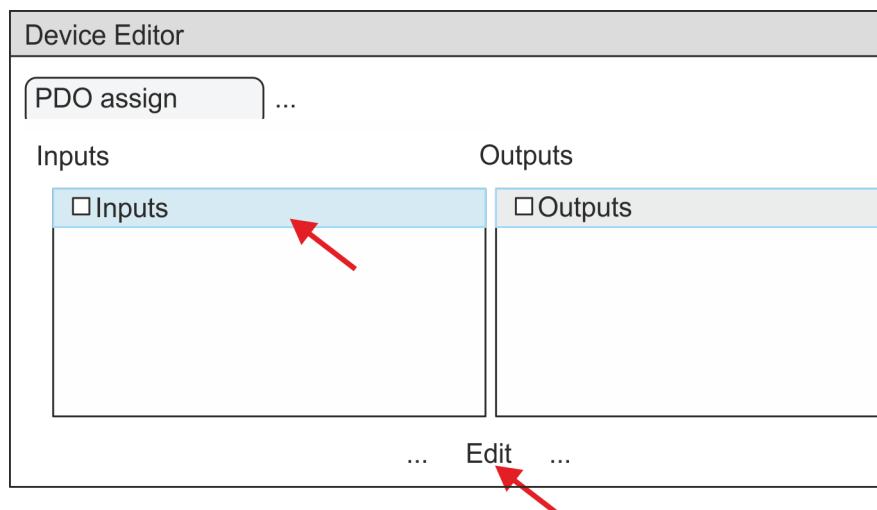

- ⇒ The dialog 'Edit PDO' is opened. Please check the PDO settings listed here and adjust them if necessary. Please also take into account the order of the 'Entries' and add them accordingly.

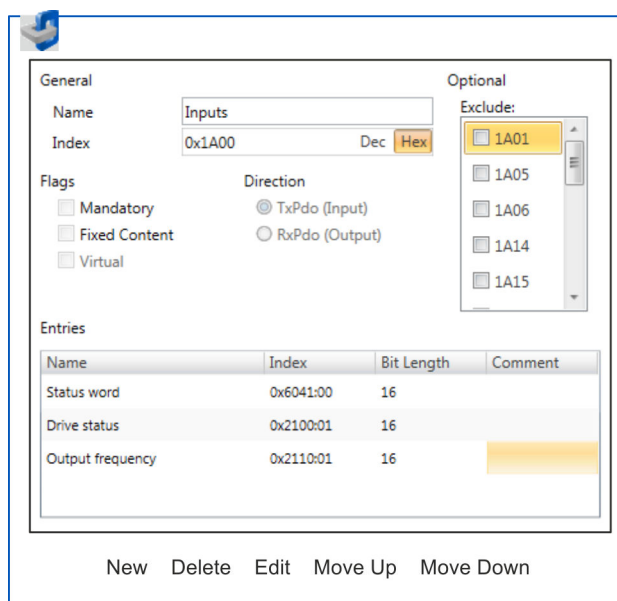

The following functions are available for editing the 'Entries':

- New
 - Here you can create a new entry in a dialog by selecting the corresponding entry from the 'CoE object dictionary' and making your settings. The entry is accepted with [OK] and is listed in the list of entries.
- Delete
 - This allows you to delete a selected entry.

- Edit
 - This allows you to edit the general data of an entry.
- Move Up/Down
 - This allows you to move the selected entry up or down in the list.

4. ➤ Perform the following settings:

Inputs

- General
 - Name: Inputs
 - Index: 0x1A00
- Flags
 - Everything de-activated
- Direction
 - TxPdo (Input): activated
- Exclude

Please note these settings, otherwise the PDO mappings can not be activated at the same time!

 - Everything de-activated
- Entries

Name	Index	Bit length
Status word	0x6041:00	16bit
Drive status value	0x2100:01	16bit
Output frequency value	0x2110:01	16bit

Close the dialog 'Edit PDO' with [OK].

5. ➤ Select the mapping 'Outputs' and click at [Edit]. Perform the following settings:

Outputs

- General
 - Name: Outputs
 - Index: 0x1600
- Flags
 - Everything de-activated
- Direction
 - RxPdo (Output): activated
- Exclude

Please note these settings, otherwise the PDO mappings can not be activated at the same time!

 - Everything de-activated
- Entries

Name	Index	Bit length
Control word	0x6040:00	16bit
vl target velocity	0x6042:00	16bit
vl velocity acceleration: Delta speed	0x6048:01	32bit
vl velocity acceleration: Delta time	0x6048:02	16bit

Close the dialog 'Edit PDO' with [OK].

6. In PDO assignment, activate each 1. PDOs "Inputs" and "Outputs". All subsequent PDOs must remain de-activated. If this is not possible, please check the respective PDO parameter 'Exclude'.

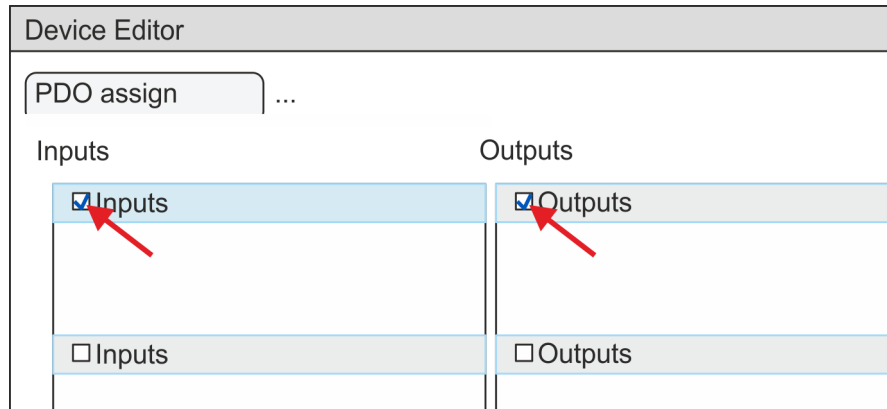

7. In the 'Device Editor' of the SPEED7 EtherCAT Manager, select the 'Distributed clocks' tab and set 'DC unused' as 'Operating mode'.

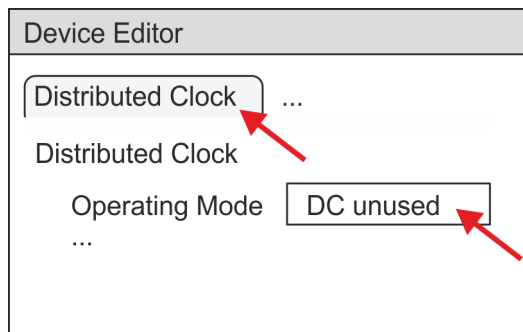

8. Select the 'Process image' tab via the arrow key in the 'Device editor' and note for the parameter of the block FB 887 - VMC_InitInverter_EC the following PDO.

- 'S7 Input address' → 'InputsStartAddressPDO'
- 'S7 Output address' → 'OutputsStartAddressPDO'

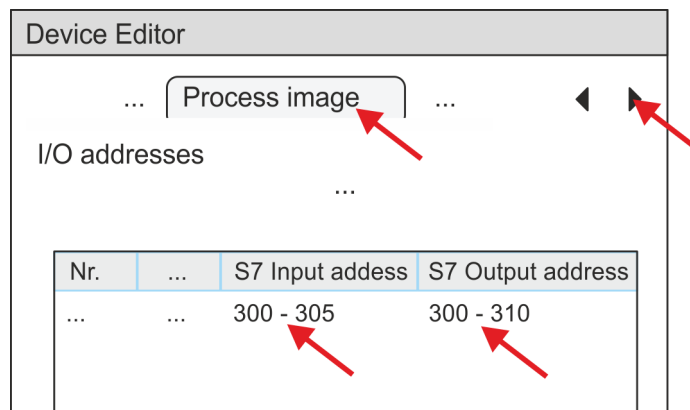

9. By closing the dialog of the SPEED7 EtherCAT Manager with [X] the configuration is taken to the SPEED7 Studio.

13.6.4.2 User program

13.6.4.2.1 Program structure

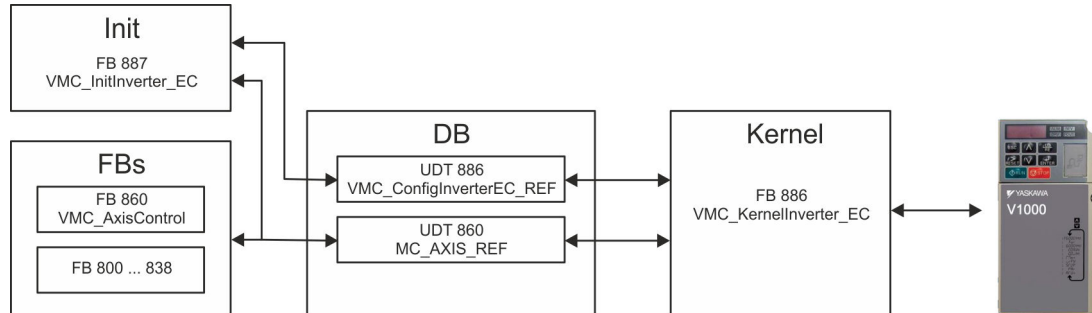

■ DB

A data block (axis DB) for configuration and status data must be created for each axis of a drive. The data block consists of the following data structures:

- UDT 886 - *VMC_ConfigInverterEC_REF*

The data structure describes the structure of the configuration of the drive. Specific data structure for inverter drive with EtherCAT.

- UDT 860 - *MC_AXIS_REF*

The data structure describes the structure of the parameters and status information of drives.

General data structure for all drives and bus systems.

■ FB 887 - *VMC_InitInverter_EC*

- The *Init* block is used to configure an axis.
- Specific block for inverter drive with EtherCAT.
- The configuration data for the initialization must be stored in the *axis DB*.

■ FB 886 - *VMC_KernelInverter_EC*

- The *Kernel* block communicates with the drive via the appropriate bus system, processes the user requests and returns status messages.
- Specific block for inverter drive with EtherCAT.
- The exchange of the data takes place by means of the *axis DB*.

■ FB 860 - *VMC_AxisControl*

- General block for all drives and bus systems.
- Supports simple motion commands and returns all relevant status messages.
- The exchange of the data takes place by means of the *axis DB*.
- For motion control and status query, via the instance data of the block you can link a visualization.
- In addition to the FB 860 - *VMC_AxisControl*, *PLCopen* blocks can be used.

■ FB 800 ... FB 838 - *PLCopen*

- The *PLCopen* blocks are used to program motion sequences and status queries.
- General blocks for all drives and bus systems.

13.6.4.2.2 Programming

Copy blocks into project

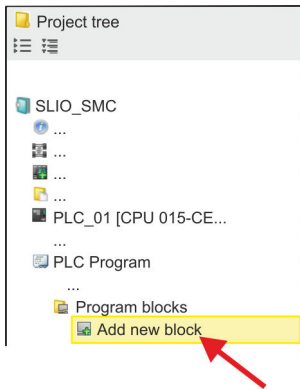

1. Click in the *Project tree* within the CPU at '*PLC program*', '*Program blocks*' at '*Add New block*'.

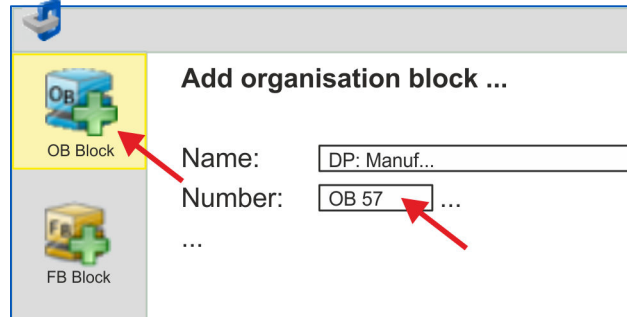

⇒ The dialog '*Add block*' is opened.

2. Select the block type '*OB block*' and add OB 57, OB 82 and OB 86 to your project.

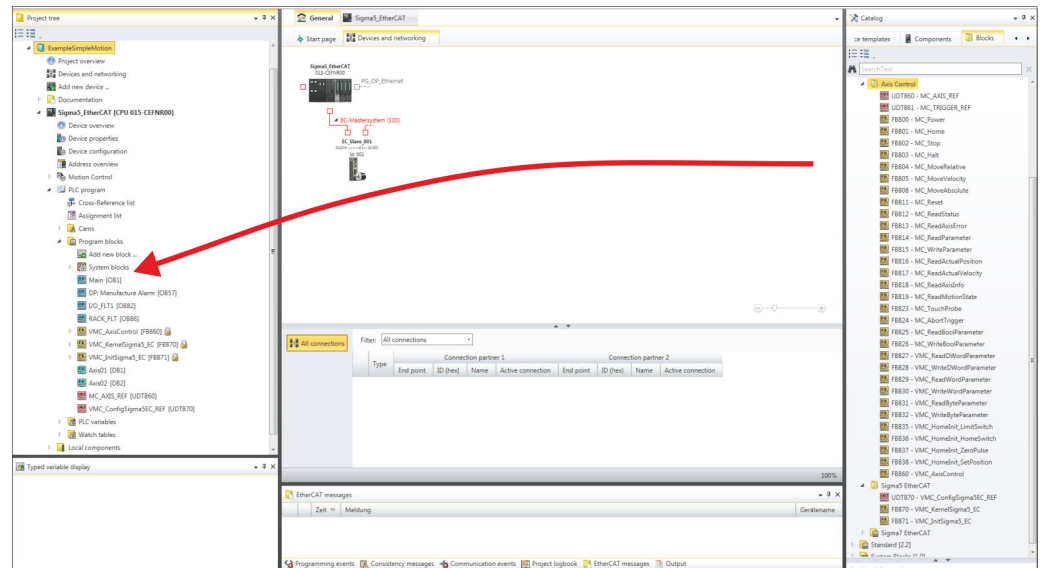

3. In the '*Catalog*', open the '*Simple Motion Control*' library at '*Blocks*' and drag and drop the following blocks into '*Program blocks*' of the *Project tree*:

- *Inverter EtherCAT*:
 - UDT 886 - VMC_ConfigInverterEC_REF
 - FB 886 - VMC_KernelInverter_EC
 - FB 887 - VMC_InitInverter_EC
- *Axis Control*
 - UDT 860 - MC_AXIS_REF
 - Blocks for your movement sequences

Create axis DB

1. Add a new DB as your *axis DB* to your project. Click in the *Project tree* within the CPU at '*PLC program*', '*Program blocks*' at '*Add New block*', select the block type '*DB block*' and assign the name "Axis01" to it. The DB number can freely be selected such as DB 10.

⇒ The block is created and opened.

2. ➔ ■ In "Axis01", create the variable "Config" of type UDT 886. These are specific axis configuration data.
- In "Axis01", create the variable "Axis" of type UDT 860. During operation, all operating data of the axis are stored here.

Axis01 [DB10]
Data block structure

	Adr...	Name	Data type	...
	...	Config	UDT	[886]
	...	Axis	UDT	[860]

OB 1

Configuration of the axis

Open OB 1 and program the following FB calls with associated DBs:

- ➔ FB 887 - VMC_InitInverter_EC, DB 887 ↪ *Chap. 13.6.6.3 'FB 887 - VMC_InitInverter_EC - inverter drive EtherCAT initialization' page 541*

At *InputsStartAddressPDO* respectively *OutputsStartAddressPDO*, enter the address from the *SPEED7 EtherCAT Manager*. ↪ 521

```
⇒ CALL "VMC_InitInverter_EC" , "DI_InitInvEC01"
   Enable           := "InitInvEC1_Enable"
   LogicalAddress   := 300
   InputsStartAddressPDO := 300 (EtherCAT-Man.: S7 Input address)
   OutputsStartAddressPDO := 300 (EtherCAT-Man.: S7 Output address)
   MaxVelocityDrive := 1.000000e+002
   MaxOutputFrequency := 6.000000e+001
   NumberOfPoles     := 6
   Valid             := "InitInvEC1_Valid"
   Error             := "InitInvEC1_Error"
   ErrorID           := "InitInvEC1_ErrorID"
   MaxVelocity       := "InitInvEC1_MaxVelocityRPM"
   Config            := "Axis01".Config
   Axis              := "Axis01".Axis
```

Connecting the Kernel for the axis

The *Kernel* processes the user commands and passes them appropriately processed on to the drive via the respective bus system.

- ➔ FB 886 - VMC_KernelInverter_EC, DB 886 ↪ *Chap. 13.6.6.2 'FB 886 - VMC_KernelInverter_EC - inverter drive EtherCAT kernel' page 541*

```
⇒ CALL "VMC_KernelInverter_EC" , "DI_KernelInvEC01"
   Init := "KernelInvEC1_Init"
   Config := "Axis01".Config
   Axis := "Axis01".Axis
```

Connecting the block for motion sequences

For simplicity, the connection of the FB 860 - VMC_AxisControl is to be shown here. This universal block supports simple motion commands and returns status messages. The inputs and outputs can be individually connected. Please specify the reference to the corresponding axis data at 'Axis' in the axis DB.

→ FB 860 - VMC_AxisControl, DB 860 ↪ *Chap. 13.7.2.2 'FB 860 - VMC_AxisControl - Control block axis control' page 544*

```

⇒      CALL  "VMC_AxisControl" , "DI_AxisControl01"
        AxisEnable           := "AxCtrl1_AxisEnable"
        AxisReset            := "AxCtrl1_AxisReset"
        HomeExecute*         := "AxCtrl1_HomeExecute"
        HomePosition*        := "AxCtrl1_HomePosition"
        StopExecute          := "AxCtrl1_StopExecute"
        MvVelocityExecute    := "AxCtrl1_MvVelExecute"
        MvRelativeExecute*   := "AxCtrl1_MvRelExecute"
        MvAbsoluteExecute*   := "AxCtrl1_MvAbsExecute"
        PositionDistance*    := "AxCtrl1_PositionDistance"
        Velocity             := "AxCtrl1_Velocity"
        Acceleration         := "AxCtrl1_Acceleration"
        Deceleration         := "AxCtrl1_Deceleration"
        JogPositive          := "AxCtrl1_JogPositive"
        JogNegative          := "AxCtrl1_JogNegative"
        JogVelocity          := "AxCtrl1_JogVelocity"
        JogAcceleration       := "AxCtrl1_JogAcceleration"
        JogDeceleration       := "AxCtrl1_JogDeceleration"
        AxisReady           := "AxCtrl1_AxisReady"
        AxisEnabled          := "AxCtrl1_AxisEnabled"
        AxisError            := "AxCtrl1_AxisError"
        AxisErrorID          := "AxCtrl1_AxisErrorID"
        DriveWarning         := "AxCtrl1_DriveWarning"
        DriveError           := "AxCtrl1_DriveError"
        DriveErrorID         := "AxCtrl1_DriveErrorID"
        IsHomed*             := "AxCtrl1_IsHomed"
        ModeOfOperation      := "AxCtrl1_ModeOfOperation"
        PLCopenState         := "AxCtrl1_PLCopenState"
        ActualPosition*      := "AxCtrl1_ActualPosition"
        ActualVelocity        := "AxCtrl1_ActualVelocity"
        CmdDone              := "AxCtrl1_CmdDone"
        CmdBusy              := "AxCtrl1_CmdBusy"
        CmdAborted           := "AxCtrl1_CmdAborted"
        CmdError             := "AxCtrl1_CmdError"
        CmdErrorID           := "AxCtrl1_CmdErrorID"
        DirectionPositive    := "AxCtrl1_DirectionPos"
        DirectionNegative     := "AxCtrl1_DirectionNeg"
        SWLimitMinActive*    := "AxCtrl1_SWLimitMinActive"
        SWLimitMaxActive*    := "AxCtrl1_SWLimitMaxActive"
        HWLimitMinActive*    := "AxCtrl1_HWLimitMinActive"
        HWLimitMaxActive*    := "AxCtrl1_HWLimitMaxActive"
        Axis                 := "Axis01".Axis
  
```

*) This Parameter is not supported by an inverter.



For complex motion tasks, you can use the PLCopen blocks. Please specify the reference to the corresponding axis data at Axis in the axis DB.

Your project now includes the following blocks:

- OB 1 - Main
- OB 57 - DP Manufacturer Alarm
- OB 82 - I/O_FLT1

- OB 86 - Rack_FLT
- FB 860 - VMC_AxisControl with instance DB
- FB 886 - VMC_KernelInverter_EC with instance DB
- FB 887 - VMC_InitInverter_EC with instance DB
- UDT 860 - MC_Axis_REF
- UDT 886 - VMC_ConfigInverterEC_REF

Sequence of operations

1. Select 'Project → Compile all' and transfer the project into your CPU. You can find more information on the transfer of your project in the online help of the *SPEED7 Studio*.

⇒ You can take your application into operation now.



CAUTION!

Please always observe the safety instructions for your drive, especially during commissioning!

2. Before an axis can be controlled, it must be initialized. To do this, call the *Init* block FB 887 - VMC_InitInverter_EC with *Enable* = TRUE.

⇒ The output *Valid* returns TRUE. In the event of a fault, you can determine the error by evaluating the *ErrorID*.

You have to call the *Init* block again if you load a new axis DB or you have changed parameters on the *Init* block.



Do not continue until the Init block does not report any errors!

3. Ensure that the *Kernel* block FB 886 - VMC_KernelInverter_EC is cyclically called. In this way, control signals are transmitted to the drive and status messages are reported.
4. Program your application with the FB 860 - VMC_AxisControl or with the PLCopen blocks.

Controlling the drive via HMI

There is the possibility to control your drive via HMI. For this, a predefined symbol library is available for Movicon to access the VMC_AxisControl function block. ↪ *Chap. 13.8 'Controlling the drive via HMI' page 613*

13.6.5 Usage in Siemens SIMATIC Manager

13.6.5.1 Precondition

Overview

- Please use for configuration the Siemens SIMATIC Manager V 5.5 SP2 and up.
- The configuration of the System SLIO CPU happens in the Siemens SIMATIC Manager by means of a virtual PROFINET IO device 'VIPA SLIO CPU'. The 'VIPA SLIO CPU' is to be installed in the hardware catalog by means of the GSDML.
- The configuration of the EtherCAT masters happens in the Siemens SIMATIC Manager by means of a virtual PROFINET IO device 'EtherCAT network'. The 'EtherCAT network' is to be installed in the hardware catalog by means of the GSDML.
- The 'EtherCAT network' can be configured with the VIPA Tool *SPEED7 EtherCAT Manager*.
- For the configuration of the drive in the *SPEED7 EtherCAT Manager* the installation of the according ESI file is necessary.

Installing the IO device 'VIPA SLIO System'

The installation of the PROFINET IO device 'VIPA SLIO CPU' happens in the hardware catalog with the following approach:

1. ➤ Go to the service area of www.vipa.com.
2. ➤ Download the configuration file for your CPU from the download area via 'Config files → PROFINET'.
3. ➤ Extract the file into your working directory.
4. ➤ Start the Siemens hardware configurator.
5. ➤ Close all the projects.
6. ➤ Select 'Options → Install new GSD file'.
7. ➤ Navigate to your working directory and install the according GSDML file.
 - ⇒ After the installation the according PROFINET IO device can be found at 'PROFINET IO → Additional field devices → I/O → VIPA SLIO System'.

Installing the IO device EtherCAT network

The installation of the PROFINET IO devices 'EtherCAT Network' happens in the hardware catalog with the following approach:

1. ➤ Go to the service area of www.vipa.com
2. ➤ Load from the download area at 'Config files → EtherCAT' the GSDML file for your EtherCAT master.
3. ➤ Extract the files into your working directory.
4. ➤ Start the Siemens hardware configurator.
5. ➤ Close all the projects.
6. ➤ Select 'Options → Install new GSD file'.
7. ➤ Navigate to your working directory and install the according GSDML file.
 - ⇒ After the installation the 'EtherCAT Network' can be found at 'PROFINET IO → Additional field devices → I/O → VIPA VIPA EtherCAT System'.

Installing the SPEED7 EtherCAT Manager

The configuration of the PROFINET IO device 'EtherCAT Network' happens by means of the *SPEED7 EtherCAT Manager* from VIPA. This may be found in the service area of www.vipa.com at 'Service/Support → Downloads → Software'.

The installation happens with the following proceeding:

1. ➤ Close the Siemens SIMATIC Manager.
2. ➤ Go to the service area of www.vipa.com
3. ➤ Load the *SPEED7 EtherCAT Manager* and unzip it on your PC.

4. ➤ For installation start the file EtherCATManager_v... .exe.
5. ➤ Select the language for the installation.
6. ➤ Accept the licensing agreement.
7. ➤ Select the installation directory and start the installation.
8. ➤ After installation you have to reboot your PC.
 - ⇒ The *SPEED7 EtherCAT Manager* is installed and can now be called via the context menu of the Siemens SIMATIC Manager.

13.6.5.2 Hardware configuration

Configuring the CPU in the project

Slot	Module
1	
2	CPU 315-2 PN/DP
X1	MPI/DP
X2	PN-IO
X2...	Port 1
X2...	Port 2
3	

To be compatible with the Siemens SIMATIC Manager the following steps should be executed:

1. ➤ Start the Siemens hardware configurator with a new project.
2. ➤ Insert a profile rail from the hardware catalog.
3. ➤ Place at 'Slot' number 2 the CPU 315-2 PN/DP (315-2EH14 V3.2).
4. ➤ The integrated PROFIBUS DP master (jack X3) is to be configured and connected via the sub module 'X1 MPI/DP'.
5. ➤ The integrated EtherCAT master is to be configured via the sub module 'X2 PN-IO' as a virtual PROFINET network.
6. ➤ Click at the sub module 'PN-IO' of the CPU.
7. ➤ Select 'Context menu → Insert PROFINET IO System'.

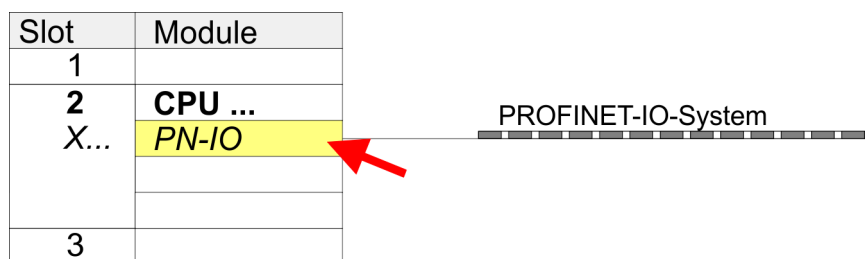

8. ➤ Create with [New] a new sub net and assign valid address data.
9. ➤ Click at the sub module 'PN-IO' of the CPU and open with 'Context menu → Properties' the properties dialog.
10. ➤ Enter at 'General' a 'Device name'. The device name must be unique at the Ethernet subnet.

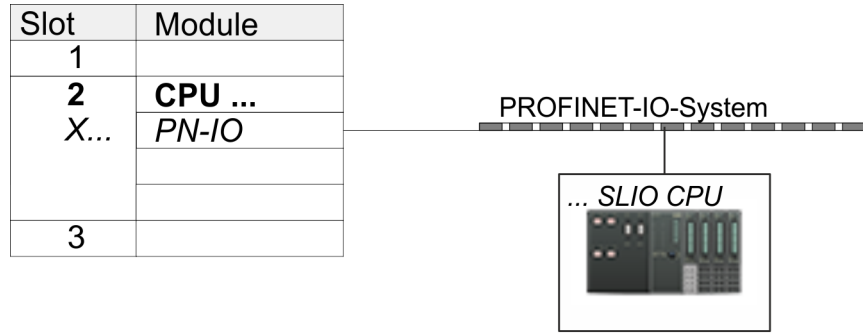

Slot	Module	Order number
0	... SLIO CPU ...	015-...
X2	015-...	
1		
2		
3		
...		

1. Navigate in the hardware catalog to the directory 'PROFINET IO' → 'Additional field devices' → 'I/O' → 'VIPA SLIO System' and connect the IO device '015-CFFNR00 CPU' to your PROFINET system.
 - ⇒ In the Device overview of the PROFINET IO device 'VIPA SLIO CPU' the CPU is already placed at slot 0. From slot 1 you can place your System SLIO modules.

Configuration of Ethernet PG/OP channel

Slot	Module
1	
2	CPU ...
X...	PN-IO
3	
4	343-1EX30
5	
...	

1. Place for the Ethernet PG/OP channel at slot 4 the Siemens CP 343-1 (SIMATIC 300 \ CP 300 \ Industrial Ethernet \ CP 343-1 \ 6GK7 343-1EX30 0XE0 V3.0).
2. Open the properties dialog by clicking on the CP 343-1EX30 and enter for the CP at 'Properties' the IP address data. You get valid IP address parameters from your system administrator.
3. Assign the CP to a 'Subnet'. The IP address data are not accepted without assignment!

Insert 'EtherCAT network'

Slot	Module
1	
2	CPU ...
X...	PN-IO
3	

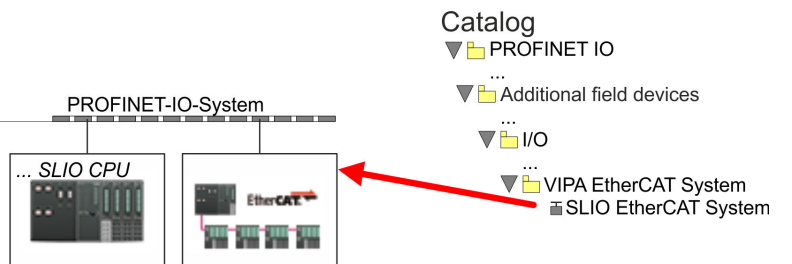

1. Navigate in the hardware catalog to the directory 'PROFINET IO' → 'Additional field devices' → 'I/O' → 'VIPA EtherCAT System' and connect the IO device 'SLIO EtherCAT System' to your PROFINET system.

Usage inverter drive via EtherCAT > Usage in Siemens SIMATIC Manager

2. Click at the inserted IO device 'EtherCAT Network' and define the areas for in and output by drag and dropping the according 'Out' or 'In' area to a slot.

Create the following areas:

- In 128byte
- Out 128byte

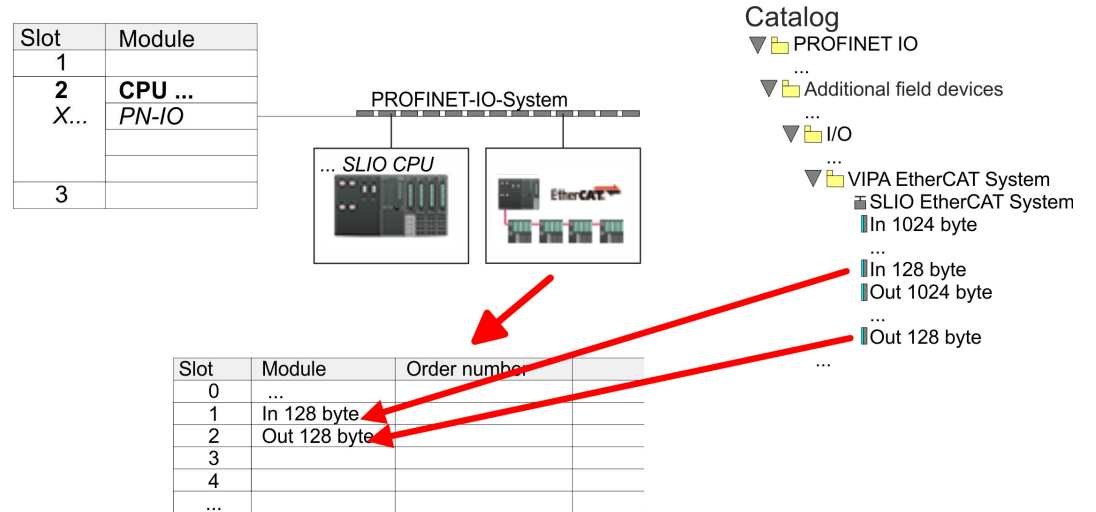

3. Select 'Station → Save and compile'

Configure inverter drive

The drive is configured in the *SPEED7 EtherCAT Manager*.



Before calling the SPEED7 EtherCAT Manager you have always to save your project with 'Station → Save and compile'.

Slot	Module
1	
2	CPU ...
X...	PN-IO
3	

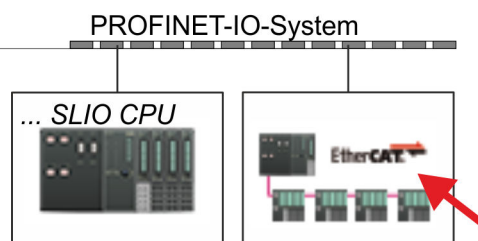

- Click at an inserted IO device 'EtherCAT Network' and select 'Context menu → Start Device-Tool → SPEED7 EtherCAT Manager'.
 - The *SPEED7 EtherCAT Manager* opens. Here you can configure the EtherCAT communication to your inverter drive.

More information about the usage of the *SPEED7 EtherCAT Manager* may be found in the according manual or online help.

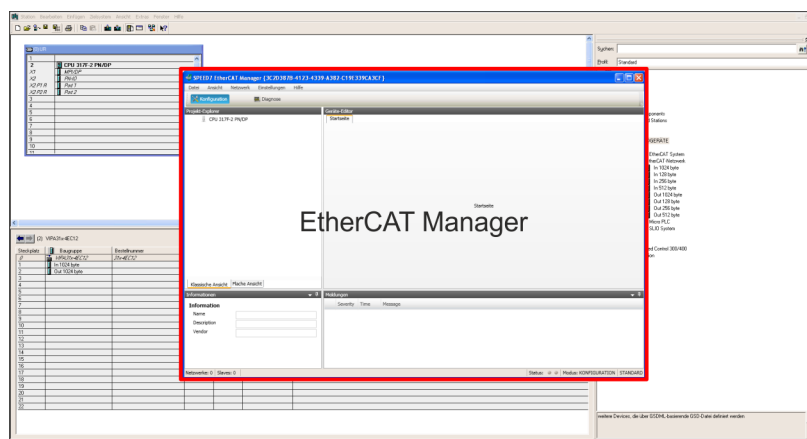

- For the inverter drive to be configured in the *SPEED7 EtherCAT Manager*, the corresponding ESI file must be installed. The ESI file for the inverter drive can be found under www.yaskawa.eu.com at 'Service → Drives & Motion Software'. Download the according ESI file for your drive. Unzip this if necessary.
- Open in the *SPEED7 EtherCAT Manager* via 'File → ESI Manager' the dialog window 'ESI Manager'.
- In the 'ESI Manager' click at [Add File] and select your ESI file. With [Open], the ESI file is installed in the *SPEED7 EtherCAT Manager*.
- Close the 'ESI Manager'.
 - Your inverter drive is now available for configuration.

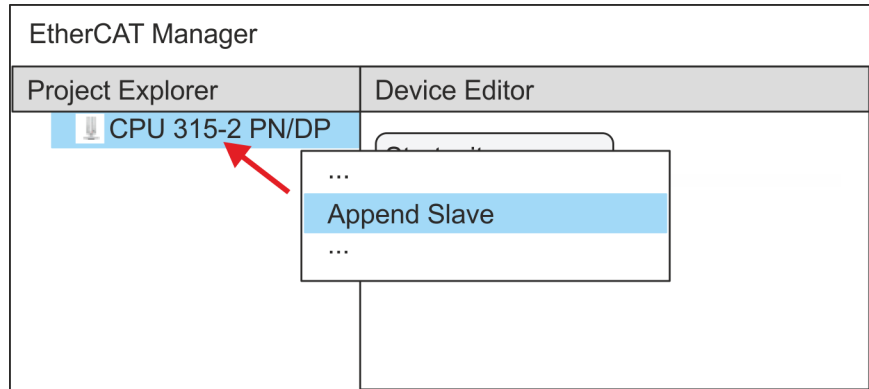

7. In the EtherCAT Manager, click on your CPU and open via 'Context menu' → 'Append Slave' the dialog box for adding an EtherCAT slave.
 - ⇒ The dialog window for selecting an EtherCAT slave is opened.
8. Select your inverter drive and confirm your selection with [OK].
 - ⇒ The inverter drive is connected to the master and can now be configured.

9.  You can only edit PDOs in 'Expert mode'! Otherwise, the buttons are hidden. By activating the 'Expert mode' you can switch to advanced setting.

By activating 'View → Expert' you can switch to the Expert mode.

10. Click on the inverter drive EtherCAT Slave in the SPEED7 EtherCAT Manager and select the 'PDO assign' tab in the 'Device editor'.

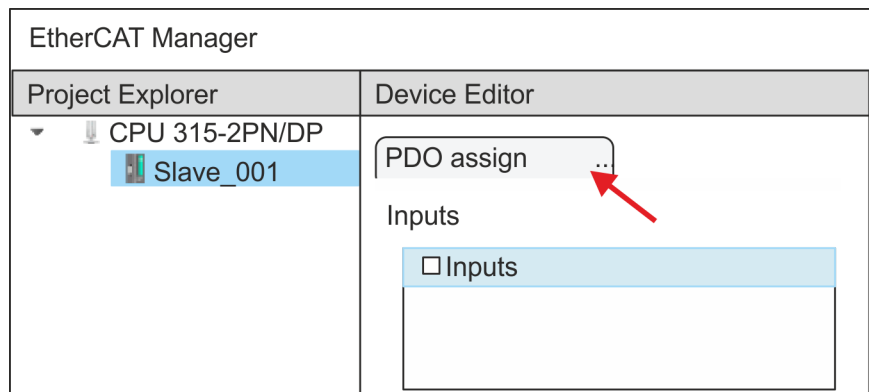

⇒ This dialog shows a list of the PDOs.

11. ➔ By selecting the appropriate PDO mapping, you can edit the PDOs with [Edit]. Select the mapping 'Inputs' and click at [Edit].



Please note that some PDOs can not be edited because of the default settings. By de-activating already activated PDOs, you can release the processing of locked PDOs.

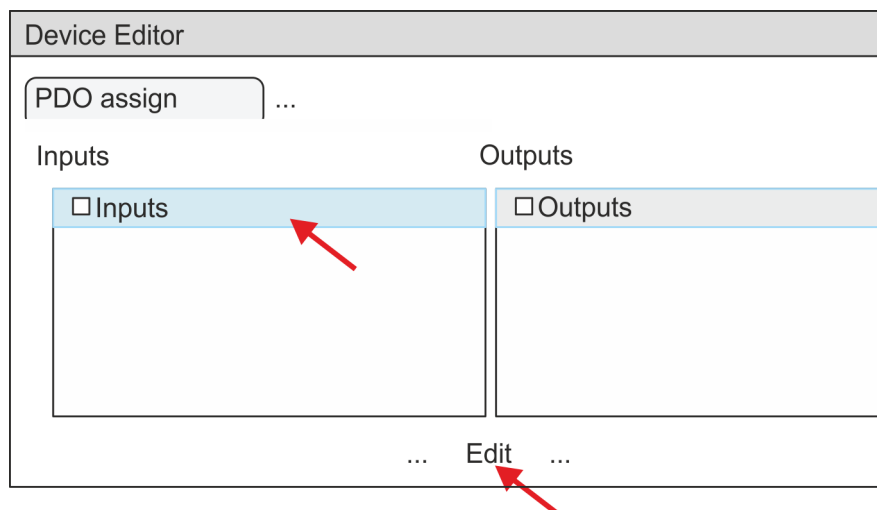

- ⇒ The dialog 'Edit PDO' is opened. Please check the PDO settings listed here and adjust them if necessary. Please also take into account the order of the 'Entries' and add them accordingly.

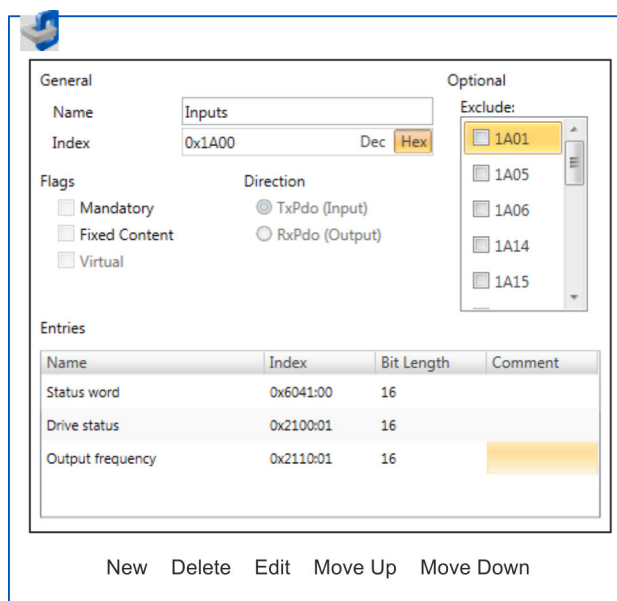

The following functions are available for editing the 'Entries':

- New
 - Here you can create a new entry in a dialog by selecting the corresponding entry from the 'CoE object dictionary' and making your settings. The entry is accepted with [OK] and is listed in the list of entries.
- Delete
 - This allows you to delete a selected entry.

- Edit
 - This allows you to edit the general data of an entry.
- Move Up/Down
 - This allows you to move the selected entry up or down in the list.

12. Perform the following settings:

Inputs

- General
 - Name: Inputs
 - Index: 0x1A00
- Flags
 - Everything de-activated
- Direction
 - TxPdo (Input): activated
- Exclude

Please note these settings, otherwise the PDO mappings can not be activated at the same time!

 - Everything de-activated
- Entries

Name	Index	Bit length
Status word	0x6041:00	16bit
Drive status value	0x2100:01	16bit
Output frequency value	0x2110:01	16bit

Close the dialog 'Edit PDO' with [OK].

13. Select the mapping '1st Receive PDO mapping' and click at [Edit]. Perform the following settings:

Outputs

- General
 - Name: Outputs
 - Index: 0x1600
- Flags
 - Everything de-activated
- Direction
 - RxPdo (Output): activated
- Exclude

Please note these settings, otherwise the PDO mappings can not be activated at the same time!

 - Everything de-activated
- Entries

Name	Index	Bit length
Control word	0x6040:00	16bit
vI target velocity	0x6042:00	16bit
vI velocity acceleration: Delta speed	0x6048:01	32bit
vI velocity acceleration: Delta time	0x6048:02	16bit

Close the dialog 'Edit PDO' with [OK].

- 14.** In PDO assignment, activate each 1. PDOs "Inputs" and "Outputs". All subsequent PDOs must remain de-activated. If this is not possible, please check the respective PDO parameter 'Exclude'.

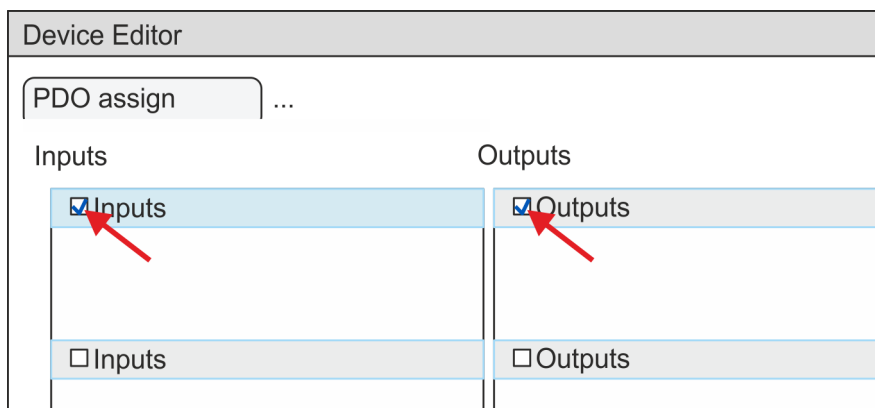

- 15.** In the 'Device Editor' of the SPEED7 EtherCAT Manager, select the 'Distributed clocks' tab and set 'DC unused' as 'Operating mode'.

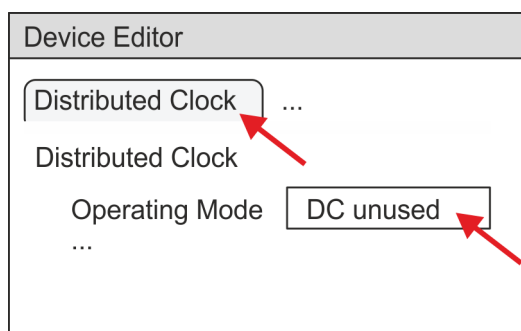

- 16.** Select the 'Process image' tab via the arrow key in the 'Device editor' and note for the parameter of the block FB 887 - VMC_InitInverter_EC the following PDO.

- 'S7 Input address' → 'InputsStartAddressPDO'
- 'S7 Output address' → 'OutputsStartAddressPDO'

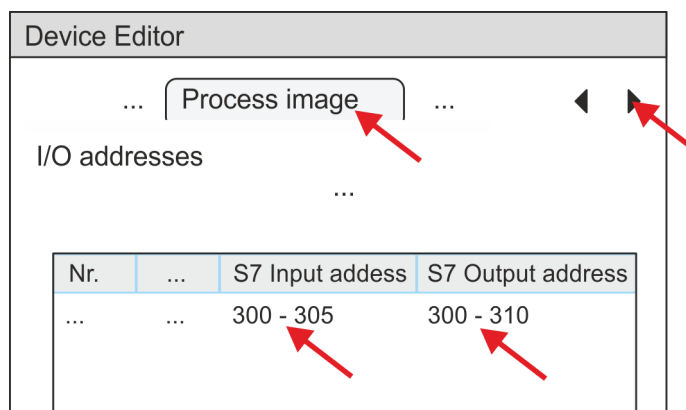

- 17.** By closing the SPEED7 EtherCAT Manager with [X] the configuration is taken to the project. You can always edit your EtherCAT configuration in the SPEED7 EtherCAT Manager, since the configuration is stored in your project.
- 18.** Save and compile your configuration

13.6.5.3 User program

13.6.5.3.1 Program structure

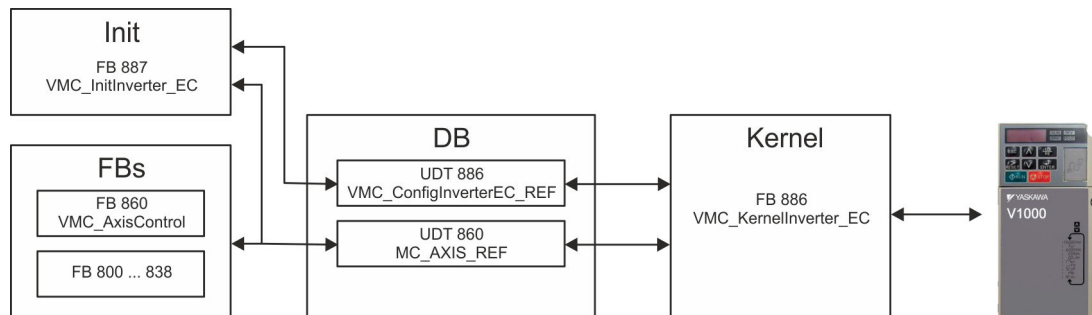

■ DB

A data block (axis DB) for configuration and status data must be created for each axis of a drive. The data block consists of the following data structures:

- UDT 886 - *VMC_ConfigInverterEC_REF*

The data structure describes the structure of the configuration of the drive. Specific data structure for inverter drive with EtherCAT.

- UDT 860 - *MC_AXIS_REF*

The data structure describes the structure of the parameters and status information of drives.

General data structure for all drives and bus systems.

■ FB 887 - *VMC_InitInverter_EC*

- The *Init* block is used to configure an axis.
- Specific block for inverter drive with EtherCAT.
- The configuration data for the initialization must be stored in the *axis DB*.

■ FB 886 - *VMC_KernelInverter_EC*

- The *Kernel* block communicates with the drive via the appropriate bus system, processes the user requests and returns status messages.
- Specific block for inverter drive with EtherCAT.
- The exchange of the data takes place by means of the *axis DB*.

■ FB 860 - *VMC_AxisControl*

- General block for all drives and bus systems.
- Supports simple motion commands and returns all relevant status messages.
- The exchange of the data takes place by means of the *axis DB*.
- For motion control and status query, via the instance data of the block you can link a visualization.

– In addition to the FB 860 - *VMC_AxisControl*, *PLCopen* blocks can be used.

■ FB 800 ... FB 838 - *PLCopen*

- The *PLCopen* blocks are used to program motion sequences and status queries.
- General blocks for all drives and bus systems.

13.6.5.3.2 Programming

Include library

1. ➤ Go to the service area of www.vipa.com.
2. ➤ Download the *Simple Motion Control* library from the download area at '*VIPA Lib*'.
3. ➤ Open the dialog window for ZIP file selection via '*File* ➔ *Retrieve*'.
4. ➤ Select the according ZIP file and click at [Open].

5. ➤ Specify a target directory in which the blocks are to be stored and start the unzip process with [OK].

Copy blocks into project

- Open the library after unzipping and drag and drop the following blocks into 'Blocks' of your project:
 - Inverter EtherCAT:
 - UDT 886 - VMC_ConfigInverterEC_REF
 - FB 886 - VMC_KernellInverter_EC
 - FB 887 - VMC_InitInverter_EC
 - Axis Control
 - UDT 860 - MC_AXIS_REF
 - Blocks for your movement sequences

Create interrupt OBs

1. ➤ In your project, click at 'Blocks' and choose 'Context menu ➔ Insert new object ➔ Organization block'.
 - ⇒ The dialog 'Properties Organization block' opens.
2. ➤ Add OB 57, OB 82, and OB 86 successively to your project.

Create axis DB

1. ➤ In your project, click at 'Blocks' and choose 'Context menu ➔ Insert new object ➔ Data block'.

Specify the following parameters:

 - Name and type
 - The DB no. as 'Name' can freely be chosen, such as DB 10.
 - Set 'Shared DB' as the 'Type'.
 - Symbolic name
 - Specify "Axis01".

Confirm your input with [OK].

 - ⇒ The block is created.
2. ➤ Open DB 10 "Axis01" by double-click.
 - In "Axis01", create the variable "Config" of type UDT 886. These are specific axis configuration data.
 - In "Axis01", create the variable "Axis" of type UDT 860. During operation, all operating data of the axis are stored here.

DB10

Address	Name	Typ	...
		Struct	
...	Config	"VMC_ConfigInverterEC_REF"	
...	Axis	"MC_AXIS_REF"	
...		END_STRUCT	

OB 1**Configuration of the axis**

Open OB 1 and program the following FB calls with associated DBs:

➔ FB 887 - VMC_InitInverter_EC, DB 887 ↪ *Chap. 13.6.6.3 'FB 887 - VMC_InitInverter_EC - inverter drive EtherCAT initialization' page 541*

At *InputsStartAddressPDO* respectively *OutputsStartAddressPDO*, enter the address from the *SPEED7 EtherCAT Manager*. ↪ 536

```
⇒ CALL "VMC_InitInverter_EC" , "DI_InitInvEC01"
   Enable           := "InitInvEC1_Enable"
   LogicalAddress   := 300
   InputsStartAddressPDO := 300 (EtherCAT-Man.: S7 Input
   address)
   OutputsStartAddressPDO := 300 (EtherCAT-Man.: S7 Output
   address)
   MaxVelocityDrive := 1.000000e+002
   MaxOutputFrequency := 6.000000e+001
   NumberOfPoles     := 6
   Valid             := "InitInvEC1_Valid"
   Error             := "InitInvEC1_Error"
   ErrorID           := "InitInvEC1_ErrorID"
   MaxVelocity       := "InitInvEC1_MaxVelocityRPM"
   Config            := "Axis01".Config
   Axis              := "Axis01".Axis
```

Connecting the Kernel for the axis

The *Kernel* processes the user commands and passes them appropriately processed on to the drive via the respective bus system.

➔ FB 886 - VMC_KernelInverter_EC, DB 886 ↪ *Chap. 13.6.6.2 'FB 886 - VMC_KernelInverter_EC - inverter drive EtherCAT kernel' page 541*

```
⇒ CALL "VMC_KernelInverter_EC" , "DI_KernelInvEC01"
   Init := "KernelInvEC1_Init"
   Config := "Axis01".Config
   Axis := "Axis01".Axis
```

Connecting the block for motion sequences

For simplicity, the connection of the FB 860 - VMC_AxisControl is to be shown here. This universal block supports simple motion commands and returns status messages. The inputs and outputs can be individually connected. Please specify the reference to the corresponding axis data at 'Axis' in the axis DB.

→ FB 860 - VMC_AxisControl, DB 860 ↪ *Chap. 13.7.2.2 'FB 860 - VMC_AxisControl - Control block axis control' page 544*

```
⇒ CALL "VMC_AxisControl" , "DI_AxisControl01"
   AxisEnable      := "AxCtrl1_AxisEnable"
   AxisReset       := "AxCtrl1_AxisReset"
   HomeExecute     := "AxCtrl1_HomeExecute"
   HomePosition    := "AxCtrl1_HomePosition"
   StopExecute     := "AxCtrl1_StopExecute"
   MvVelocityExecute := "AxCtrl1_MvVelExecute"
   MvRelativeExecute := "AxCtrl1_MvRelExecute"
   MvAbsoluteExecute := "AxCtrl1_MvAbsExecute"
   PositionDistance := "AxCtrl1_PositionDistance"
   Velocity        := "AxCtrl1_Velocity"
   Acceleration    := "AxCtrl1_Acceleration"
   Deceleration    := "AxCtrl1_Deceleration"
   JogPositive     := "AxCtrl1_JogPositive"
   JogNegative     := "AxCtrl1_JogNegative"
   JogVelocity     := "AxCtrl1_JogVelocity"
   JogAcceleration := "AxCtrl1_JogAcceleration"
   JogDeceleration := "AxCtrl1_JogDeceleration"
   AxisReady      := "AxCtrl1_AxisReady"
   AxisEnabled    := "AxCtrl1_AxisEnabled"
   AxisError      := "AxCtrl1_AxisError"
   AxisErrorID    := "AxCtrl1_AxisErrorID"
   DriveWarning   := "AxCtrl1_DriveWarning"
   DriveError     := "AxCtrl1_DriveError"
   DriveErrorID   := "AxCtrl1_DriveErrorID"
   IsHomed        := "AxCtrl1_IsHomed"
   ModeOfOperation := "AxCtrl1_ModeOfOperation"
   PLCOpenState   := "AxCtrl1_PLCOpenState"
   ActualPosition := "AxCtrl1_ActualPosition"
   ActualVelocity := "AxCtrl1_ActualVelocity"
   CmdDone        := "AxCtrl1_CmdDone"
   CmdBusy        := "AxCtrl1_CmdBusy"
   CmdAborted     := "AxCtrl1_CmdAborted"
   CmdError       := "AxCtrl1_CmdError"
   CmdErrorID     := "AxCtrl1_CmdErrorID"
   DirectionPositive := "AxCtrl1_DirectionPos"
   DirectionNegative := "AxCtrl1_DirectionNeg"
   SWLimitMinActive := "AxCtrl1_SWLimitMinActive"
   SWLimitMaxActive := "AxCtrl1_SWLimitMaxActive"
   HWLimitMinActive := "AxCtrl1_HWLimitMinActive"
   HWLimitMaxActive := "AxCtrl1_HWLimitMaxActive"
   Axis           := "Axis01".Axis
```



For complex motion tasks, you can use the PLCOpen blocks. Please specify the reference to the corresponding axis data at Axis in the axis DB.

Your project now includes the following blocks:

- OB 1 - Main
- OB 57 - DP Manufacturer Alarm
- OB 82 - I/O_FLT1
- OB 86 - Rack_FLT
- FB 860 - VMC_AxisControl with instance DB

- FB 886 - VMC_KernelInverter_EC with instance DB
- FB 887 - VMC_InitInverter_EC with instance DB
- UDT 860 - MC_Axis_REF
- UDT 886 - VMC_ConfigInverterEC_REF

Sequence of operations

1. ➤ Choose the Siemens SIMATIC Manager and transfer your project into the CPU.
The transfer can only be done by the Siemens SIMATIC Manager - not hardware configurator!



Since slave and module parameters are transmitted by means of SDO respectively SDO Init command, the configuration remains active, until a power cycle is performed or new parameters for the same SDO objects are transferred.

With an overall reset the slave and module parameters are not reset!

⇒ You can take your application into operation now.



CAUTION!

Please always observe the safety instructions for your drive, especially during commissioning!

2. ➤ Before an axis can be controlled, it must be initialized. To do this, call the *Init* block FB 887 - VMC_InitInverter_EC with *Enable* = TRUE.
 - ⇒ The output *Valid* returns TRUE. In the event of a fault, you can determine the error by evaluating the *ErrorID*.

You have to call the *Init* block again if you load a new axis DB or you have changed parameters on the *Init* block.



Do not continue until the Init block does not report any errors!

3. ➤ Ensure that the *Kernel* block FB 886 - VMC_KernelInverter_EC is cyclically called. In this way, control signals are transmitted to the drive and status messages are reported.
4. ➤ Program your application with the FB 860 - VMC_AxisControl or with the PLCopen blocks.

Controlling the drive via HMI

There is the possibility to control your drive via HMI. For this, a predefined symbol library is available for Movicon to access the VMC_AxisControl function block. ↪ *Chap. 13.8 'Controlling the drive via HMI' page 613*

13.6.6 Drive specific blocks



The PLCopen blocks for axis control can be found here: [↗ Chap. 13.7 'Blocks for axis control' page 542](#)

13.6.6.1 UDT 886 - VMC_ConfigInverterEC_REF - inverter drive EtherCAT Data structure axis configuration

This is a user-defined data structure that contains information about the configuration data. The UDT is specially adapted to the use of an inverter drive, which is connected via EtherCAT.

13.6.6.2 FB 886 - VMC_KernelInverter_EC - inverter drive EtherCAT kernel

Description

This block converts the drive commands for an inverter drive via EtherCAT and communicates with the drive. For each inverter drive, an instance of this FB is to be cyclically called.



Please note that this module calls the SFB 238 internally.

In the SPEED7 Studio, this module is automatically inserted into your project.

In Siemens SIMATIC Manager, you have to copy the SFB 238 from the Motion Control Library into your project.

Parameter	Declaration	Data type	Description
Init	INPUT	BOOL	The block is internally reset with an edge 0-1. Existing motion commands are aborted and the block is initialized.
Config	IN_OUT	UDT 886	Data structure for transferring axis-dependent configuration data to the <i>AxisKernel</i> .
Axis	IN_OUT	UDT 860	Data structure for transferring axis-dependent information to the <i>AxisKernel</i> and PLCopen blocks.

13.6.6.3 FB 887 - VMC_InitInverter_EC - inverter drive EtherCAT initialization

Description

This block is used to configure the axis. The block is specially adapted to the use of an inverter drive, which is connected via EtherCAT.

Parameter	Declaration	Data type	Description
Config	IN_OUT	UDT 886	Data structure for transferring axis-dependent configuration data to the <i>AxisKernel</i> .
Axis	IN_OUT	UDT 860	Data structure for transferring axis-dependent information to the <i>AxisKernel</i> and PLCopen blocks.
Enable	INPUT	BOOL	Release of initialization
LogicalAddress	INPUT	INT	Start address of the PDO input data

Blocks for axis control > Overview

Parameter	Declaration	Data type	Description
InputsStartAddressPDO	INPUT	INT	Start address of the input PDOs
OutputsStartAddressPDO	INPUT	INT	Start address of the output PDOs
MaxVelocityDrive	INPUT	REAL	Maximum application speed [u].
MaxOutputFrequency	INPUT	REAL	Maximum output frequency [Hz]. Please transfer the value from the software tool <i>Drive Wizard+</i> here.
NumberOfPoles	INPUT	INT	Number of poles. Please transfer the value from the software tool <i>Drive Wizard+</i> here.
Valid	OUTPUT	BOOL	Initialization <ul style="list-style-type: none"> ■ TRUE: Initialization is valid.
Error	OUTPUT	BOOL	<ul style="list-style-type: none"> ■ Error <ul style="list-style-type: none"> – TRUE: An error has occurred. Additional error information can be found in the parameter <i>ErrorID</i>. The axis is disabled.
ErrorID	OUTPUT	WORD	Additional error information ↗ Chap. 13.10 'ErrorID - Additional error information' page 637
MaxVelocity	OUTPUT	INT	Maximum velocity in [rpm]. This value is determined automatically.

13.7 Blocks for axis control

13.7.1 Overview



At Axis Control the blocks for programming motion tasks and status queries can be found. The following components can only be used to control the following drive systems.

- Sigma-5 EtherCAT
- Sigma-7S EtherCAT
- Sigma-7W EtherCAT
- Inverter drive (inverter) via EtherCAT

Please note that there are also restrictions here. The supported blocks can be found in the following table.

Simple motion tasks

Supported blocks	Sigma-5/7 EtherCAT	Inverter EtherCAT	Page
UDT 860 - MC_AXIS_REF - data structure for axis	yes	yes	↗ 544
FB 860 - VMC_AxisControl - control of drive functions and query of drive states	yes	yes	↗ 544

Complex motion tasks - PLCopen blocks

Supported blocks	Sigma-5/7 EtherCAT	Inverter EtherCAT	Page
UDT 860 - MC_AXIS_REF - data structure for axis	yes	yes	548
UDT 861 - MC_TRIGGER_REF - data structure	yes	no	548
FB 800 - MC_Power - enable respectively disable axis	yes	yes	549
FB 801 - MC_Home - home axis	yes	no	551
FB 802 - MC_Stop - stop axis	yes	yes	553
FB 803 - MC_Halt - stop axis	yes	yes	555
FB 804 - MC_MoveRelative - move axis relative	yes	no	557
FB 805 - MC_MoveVelocity - drive axis with constant velocity	yes	yes	559
FB 808 - MoveAbsolute - move axis to absolute position	yes	no	561
FB 811 - MC_Reset - reset axis	yes	yes	563
FB 812 - MC_ReadStatus - read PLCopen-State of the axis	yes	yes	565
FB 813 - MC_ReadAxisError - read axis error	yes	yes	567
FB 814 - MC_ReadParameter - read parameter data from axis	yes	yes	569
FB 815 - MC_WriteParameter - write parameter data to axis	yes	yes	571
FB 816 - MC_ReadActualPosition - read the current position of the axis	yes	no	573
FB 817 - MC_ReadActualVelocity - read the current velocity of the axis	yes	yes	575
FB 818 - MC_ReadAxisInfo - read axis additional information	yes	yes	577
FB 819 - MC_ReadMotionState - read state motion job	yes	yes	579
FB 823 - MC_TouchProbe - touch probe	yes	no	581
FB 824 - MC_AbortTrigger - abort touch probe	yes	no	583
FB 825 - MC_ReadBoolParameter - read boolean parameter from axis	yes	yes	584
FB 826 - MC_WriteBoolParameter - write boolean parameter to axis	yes	yes	586
FB 827 - VMC_ReadDWordParameter - read double-word parameter from axis	yes	yes	588
FB 828 - VMC_WriteDWordParameter - write double-word parameter to axis	yes	yes	590
FB 829 - VMC_ReadDWordParameter - read word parameter from axis	yes	yes	592
FB 830 - VMC_WriteDWordParameter - write word parameter to axis	yes	yes	594
FB 831 - VMC_ReadByteParameter - read byte parameter from axis	yes	yes	596
FB 832 - MC_WriteParameter - write byte parameter to axis	yes	yes	598
FB 833 - VMC_ReadDriveParameter - read drive parameter from drive	yes	yes	600
FB 834 - VMC_WriteParameter - write drive parameter to drive	yes	yes	602
FB 835 - VMC_HomeInit_LimitSwitch - initialization of homing on limit switch	yes	no	604
FB 836 - VMC_HomeInit_HomeSwitch - initialization of homing on home switch	yes	no	606
FB 837 - VMC_HomeInit_ZeroPulse - initialization of homing on zero pulse	yes	no	608
FB 838 - VMC_HomeInit_SetPosition - initialization of homing mode set position	yes	no	610

13.7.2 Simple motion tasks

13.7.2.1 UDT 860 - MC_AXIS_REF - Data structure axis data

This is a user-defined data structure that contains status information of the axis.

13.7.2.2 FB 860 - VMC_AxisControl - Control block axis control

Description

With the FB *VMC_AxisControl* you can control the connected axis. You can check the status of the drive, turn the drive on or off, or execute various motion commands. A separate memory area is located in the instance data of the block. You can control your axis by means of an HMI. ↪ *Chap. 13.8 'Controlling the drive via HMI' page 613*



The VMC_AxisControl block should never be used simultaneously with the PLCopen module MC_Power. Since the VMC_AxisControl contains functionalities of the MC_Power and the latest command from the VMC_Kernel module is always executed, this can lead to a faulty behavior of the drive.

Parameter

Parameter	Declaration	Data type	Description
AxisEnable	INPUT	BOOL	<ul style="list-style-type: none"> ■ Enable/disable axis <ul style="list-style-type: none"> – TRUE: The axis is enabled. – FALSE: The axis is disabled.
AxisReset	INPUT	BOOL	<ul style="list-style-type: none"> ■ Reset axis <ul style="list-style-type: none"> – Edge 0-1: Axis reset is performed.
HomeExecute	INPUT	BOOL	<ul style="list-style-type: none"> ■ Homing <ul style="list-style-type: none"> – Edge 0-1: Homing is started.
HomePosition	INPUT	REAL	With a successful homing the current position of the axis is uniquely set to Position. Position is to be entered in the used application unit.
StopExecute	INPUT	BOOL	<ul style="list-style-type: none"> ■ Stop axis <ul style="list-style-type: none"> – Edge 0-1: Stopping of the axis is started.
MvVelocityExecute	INPUT	BOOL	<ul style="list-style-type: none"> ■ Start moving the axis <ul style="list-style-type: none"> – Edge 0-1: The axis is accelerated / decelerated to the speed specified.
MvRelativeExecute	INPUT	BOOL	<ul style="list-style-type: none"> ■ Start moving the axis <ul style="list-style-type: none"> – Edge 0-1: The relative positioning of the axis is started.
MvAbsoluteExecute	INPUT	BOOL	<ul style="list-style-type: none"> ■ Start moving the axis <ul style="list-style-type: none"> – Edge 0-1: The absolute positioning of the axis is started.
Direction *	INPUT	BYTE	Mode for absolute positioning: <ul style="list-style-type: none"> ■ 0: shortest distance ■ 1: positive direction ■ 2: negative direction ■ 3: current direction
PositionDistance	INPUT	REAL	Absolute position or relative distance depending on the command in [user units].

Parameter	Declaration	Data type	Description
Velocity	INPUT	REAL	Velocity setting (signed value) in [user units / s].
Acceleration	INPUT	REAL	Acceleration in [user units / s ²].
Deceleration	INPUT	REAL	Deceleration in [user units / s ²].
JogPositive	INPUT	BOOL	<ul style="list-style-type: none"> ■ Drive axis with constant velocity in positive direction <ul style="list-style-type: none"> – Edge 0-1: Drive axis with constant velocity is started. – Edge 1-0: The axis is stopped.
JogNegative	INPUT	BOOL	<ul style="list-style-type: none"> ■ Drive axis with constant velocity in negative direction <ul style="list-style-type: none"> – Edge 0-1: Drive axis with constant velocity is started. – Edge 1-0: The axis is stopped.
JogVelocity	INPUT	REAL	Speed setting for jogging (positive value) in [user units / s].
JogAcceleration	INPUT	REAL	Acceleration in [user units / s ²].
JogDeceleration	INPUT	REAL	Delay for jogging in [user units / s ²].
AxisReady	OUTPUT	BOOL	<ul style="list-style-type: none"> ■ AxisReady <ul style="list-style-type: none"> – TRUE: The axis is ready to switch on. – FALSE: The axis is not ready to switch on. <ul style="list-style-type: none"> → Check and fix AxisError (see <i>AxisErrorID</i>). → Check and fix DriveError (see <i>DriveErrorID</i>). → Check initialization FB (input and output addresses or PDO mapping correct?)
AxisEnabled	OUTPUT	BOOL	<ul style="list-style-type: none"> ■ Status axis <ul style="list-style-type: none"> – TRUE: Axis is switched on and accepts motion commands. – FALSE: Axis is not switched on and does not accept motion commands.
AxisError	OUTPUT	BOOL	<ul style="list-style-type: none"> ■ Motion axis error <ul style="list-style-type: none"> – TRUE: An error has occurred. <p>Additional error information can be found in the parameter <i>AxisErrorID</i>.</p> <p>→ The axis is disabled.</p>
AxisErrorID	OUTPUT	WORD	<p>Additional error information</p> <p>↳ <i>Chap. 13.10 'ErrorID - Additional error information' page 637</i></p>
DriveWarning	OUTPUT	BOOL	<ul style="list-style-type: none"> ■ Warning <ul style="list-style-type: none"> – TRUE: There is a warning on the drive. <p>Additional information can be found in the manufacturer's manual.</p>
DriveError	OUTPUT	BOOL	<ul style="list-style-type: none"> ■ Error on the drive <ul style="list-style-type: none"> – TRUE: An error has occurred. <p>Additional error information can be found in the parameter <i>DriveErrorID</i>.</p> <p>→ The axis is disabled.</p>

Blocks for axis control > Simple motion tasks

Parameter	Declaration	Data type	Description
DriveErrorID	OUTPUT	WORD	<ul style="list-style-type: none"> ■ Error <ul style="list-style-type: none"> – TRUE: There is an error on the drive. <p>Additional information can be found in the manufacturer's manual.</p>
IsHomed	OUTPUT	BOOL	<ul style="list-style-type: none"> ■ Information axis: homed <ul style="list-style-type: none"> – TRUE: The axis is homed.
ModeOfOperation	OUTPUT	INT	<p>Drive-specific mode. For further information see drive manual.</p> <p>Example <i>Sigma-5</i>:</p> <p>0: No mode changed/no mode assigned 1: Profile Position mode 2: Reserved (keep last mode) 3: Profile Velocity mode 4: Torque Profile mode 6: Homing mode 7: Interpolated Position mode 8: Cyclic Sync Position mode 9: Cyclic Sync Velocity mode 10: Cyclic Sync Torque mode Other Reserved (keep last mode)</p>
PLCopenState	OUTPUT	INT	<p>Current PLCopenState:</p> <p>1: Disabled 2: Standstill 3: Homing 4: Discrete Motion 5: Continuous Motion 7: Stopping 8: Errorstop</p>
ActualPosition	OUTPUT	REAL	Position of the axis in [user unit].
ActualVelocity	OUTPUT	REAL	Velocity of the axis in [user unit / s]
CmdDone	OUTPUT	BOOL	<ul style="list-style-type: none"> ■ Status <ul style="list-style-type: none"> – TRUE: Job ended without error.
CmdBusy	OUTPUT	BOOL	<ul style="list-style-type: none"> ■ Status <ul style="list-style-type: none"> – TRUE: Job is running.
CmdAborted	OUTPUT	BOOL	<ul style="list-style-type: none"> ■ Status <ul style="list-style-type: none"> – TRUE: The job was aborted during processing by another job.
CmdError	OUTPUT	BOOL	<ul style="list-style-type: none"> ■ Status <ul style="list-style-type: none"> – TRUE: An error has occurred. <p>Additional error information can be found in the parameter <i>CmdErrorID</i>.</p>

Parameter	Declaration	Data type	Description
CmdErrorID	OUTPUT	WORD	Additional error information <ul style="list-style-type: none"> ☞ Chap. 13.10 'ErrorID - Additional error information' page 637
DirectionPositive	OUTPUT	BOOL	<ul style="list-style-type: none"> ■ Status motion job: Position increasing <ul style="list-style-type: none"> – TRUE: The position of the axis is increasing
DirectionNegative	OUTPUT	BOOL	<ul style="list-style-type: none"> ■ Status motion job: Position decreasing <ul style="list-style-type: none"> – TRUE: The position of the axis is decreasing
SWLimitMinActive	OUTPUT	BOOL	<ul style="list-style-type: none"> ■ Software limit switch <ul style="list-style-type: none"> – TRUE: Software Limit switch Minimum active (Minimum position in negative direction exceeded).
SWLimitMaxActive	OUTPUT	BOOL	<ul style="list-style-type: none"> ■ Software limit switch <ul style="list-style-type: none"> – TRUE: Software limit switch Maximum active (Maximum position in positive direction exceeded).
HWLimitMinActive	OUTPUT	BOOL	<ul style="list-style-type: none"> ■ Hardware limit switch <ul style="list-style-type: none"> – TRUE: Negative hardware limit switch active on the drive (NOT- Negative Overtravel).
HWLimitMaxActive	OUTPUT	BOOL	<ul style="list-style-type: none"> ■ Hardware limit switch <ul style="list-style-type: none"> – TRUE: Positive hardware limit switch active on the drive (POT- Positive Overtravel).
Axis	IN_OUT	MC_AXIS_REF	Reference to the axis.

*) This parameter is not supported by all drives, e.g. *Sigma 5 via EtherCAT* does not support this parameter.

Blocks for axis control > Complex motion tasks - PLCopen blocks

13.7.3 Complex motion tasks - PLCopen blocks

13.7.3.1 UDT 860 - MC_AXIS_REF - Data structure axis data

This is a user-defined data structure that contains status information of the axis.

13.7.3.2 UDT 861 - MC_TRIGGER_REF - Data structure trigger signal

This is a user defined data structure, that contains information of the trigger signal.

13.7.3.3 FB 800 - MC_Power - enable/disable axis

Description



An overview of the drive systems, which can be controlled with this block can be found here: [Chap. 13.7.1 'Overview' page 542](#)

With MC_Power an axis can be enabled or disabled.

Parameter

Parameter	Declaration	Data type	Description
Axis	IN_OUT	MC_AXIS_REF	Reference to the axis
Enable	INPUT	BOOL	<ul style="list-style-type: none"> ■ Enable/disable axis <ul style="list-style-type: none"> – TRUE: The axis is enabled – FALSE: The axis is disabled
EnablePositive	INPUT	BOOL	Parameter is currently not supported; call with FALSE
EnableNegative	INPUT	BOOL	Parameter is currently not supported; call with FALSE
Status	OUTPUT	BOOL	<ul style="list-style-type: none"> ■ Status axis <ul style="list-style-type: none"> – TRUE: The axis is ready to execute motion control jobs – FALSE: The axis is not ready to execute motion control jobs
Valid	OUTPUT	BOOL	Always FALSE
Error	OUTPUT	BOOL	<ul style="list-style-type: none"> ■ Error <ul style="list-style-type: none"> – TRUE: An error has occurred. Additional error information can be found in the parameter <i>ErrorID</i>. The axis is disabled.
ErrorID	OUTPUT	WORD	Additional error information Chap. 13.10 'ErrorID - Additional error information' page 637

Enable axis

Call MC_Power with *Enable* = TRUE. If *Status* shows a value of TRUE, the axis is enabled. In this status motion control jobs can be activated.

Disable axis

Call MC_Power with *Enable* = FALSE. If *Status* shows a value of FALSE, the axis is disabled. When disabling the axis a possibly active motion job is cancelled and the axis is stopped.

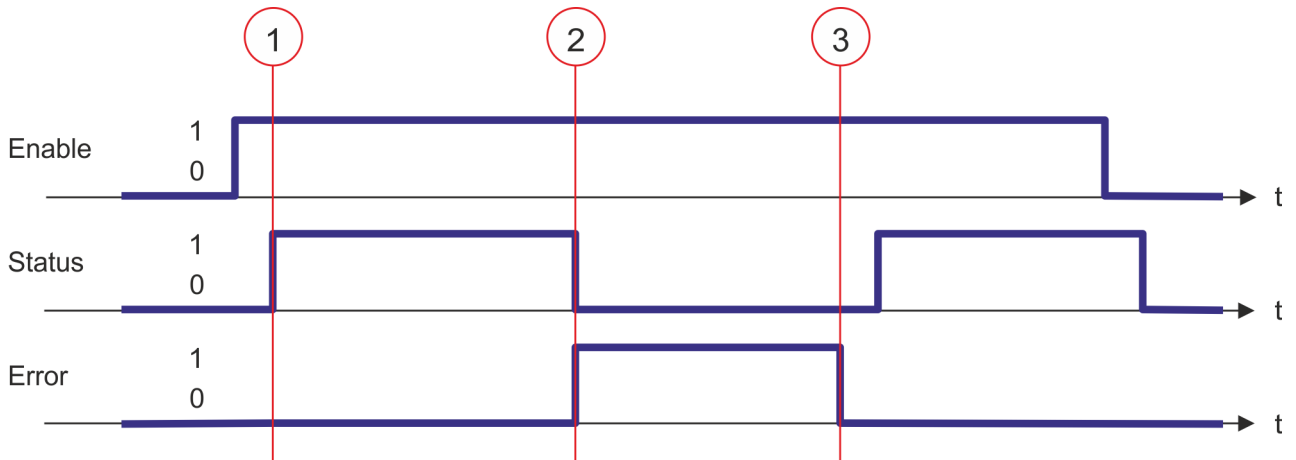
Status diagram of the block parameters

- (1) The axis is enabled with *Enable* = TRUE. At the time (1) it is enabled. Then motion control jobs can be activated.
- (2) At the time (2) an error occurs, which causes the to disable the axis. A possibly active motion job is cancelled and the axis is stopped.
- (3) The error is eliminated and acknowledged at time (3). Thus *Enable* is further set, the axis is enabled again. Finally the axis is disabled with *Enable* = FALSE.

13.7.3.4 FB 801 - MC_Home - home axis

Description



An overview of the drive systems, which can be controlled with this block can be found here: [Chap. 13.7.1 'Overview' page 542](#)

With MC_Home an axis can be set to a reference point. This is used to match the axis coordinates to the real, physical drive position. The homing method and its parameters must be configured directly at the drive. For this use the VMC_HomeInit_... blocks.

Parameter

Parameter	Declaration	Data type	Description
Axis	IN_OUT	MC_AXIS_REF	Reference to the axis
Execute	INPUT	BOOL	<ul style="list-style-type: none"> ■ Homing <ul style="list-style-type: none"> – Edge 0-1: Homing is started
Position	INPUT	REAL	<p>With a successful homing the current position of the axis is uniquely set to <i>Position</i>.</p> <p><i>Position</i> is to be entered in the used application unit.</p>
BufferMode	INPUT	BYTE	Parameter is currently not supported; call with B#16#0
Done	OUTPUT	BOOL	<ul style="list-style-type: none"> ■ Status <ul style="list-style-type: none"> – TRUE: Job successfully done.
Busy	OUTPUT	BOOL	<ul style="list-style-type: none"> ■ Status <ul style="list-style-type: none"> – TRUE: Job is running.
CommandA-borted	OUTPUT	BOOL	<ul style="list-style-type: none"> ■ Status <ul style="list-style-type: none"> – TRUE: The job was aborted during processing by another job.
Error	OUTPUT	BOOL	<ul style="list-style-type: none"> ■ Status <ul style="list-style-type: none"> – TRUE: An error has occurred. Additional error information can be found in the parameter <i>ErrorID</i>.
ErrorID	OUTPUT	WORD	<p>Additional error information</p> <p>Chap. 13.10 'ErrorID - Additional error information' page 637</p>

PLCopen-State

Start of the job only in the PLCopen-State *Standstill* possible.

Home axis

The homing is started with edge 0-1 at *Execute*. *Busy* is TRUE as soon as the homing is running. Once *Done* becomes TRUE, homing was successfully completed. The current position of the axis was set to the value of *Position*.



- An active job continues to run even when *Execute* is set to FALSE.
- A running job can not be aborted by a move job (e.g. MC_MoveRelative).

Status diagram of the block parameters

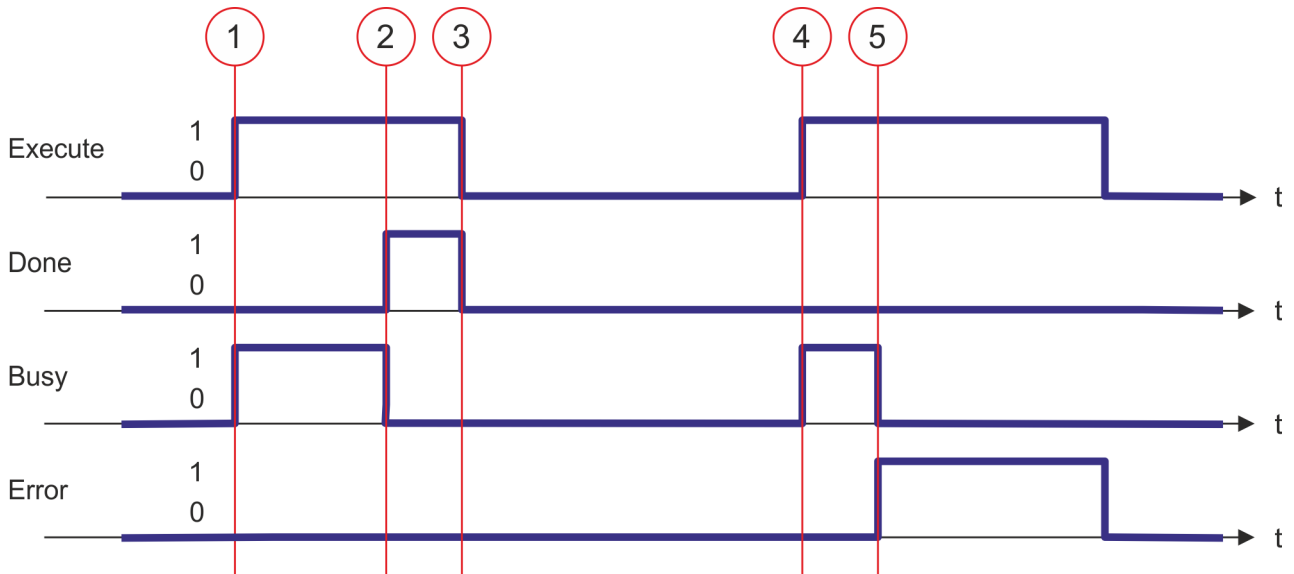

- (1) The homing is started with edge 0-1 at *Execute* and *Busy* becomes TRUE.
- (2) At the time (2) the homing is completed. *Busy* has the value FALSE and *Done* den value TRUE.
- (3) At the time (3) the job is completed and *Execute* becomes FALSE and thus each output parameter FALSE respectively 0.
- (4) At the time (4) with an edge 0-1 at *Execute* the homing is started again and *Busy* becomes TRUE.
- (5) At the time (5) an error occurs during homing. *Busy* has the value FALSE and *ERROR* den value TRUE.

13.7.3.5 FB 802 - MC_Stop - stop axis

Description



An overview of the drive systems, which can be controlled with this block can be found here: [↪ Chap. 13.7.1 'Overview' page 542](#)

With MC_STOP the axis is stopped. With the parameter *Deceleration*, the dynamic behavior can be determined during stopping.

Parameter

Parameter	Declaration	Data type	Description
Axis	IN_OUT	MC_AXIS_REF	Reference to the axis
Execute	INPUT	BOOL	<ul style="list-style-type: none"> ■ Stop axis <ul style="list-style-type: none"> – Edge 0-1: Stopping of the axis is started
Deceleration	INPUT	REAL	Delay in stopping in [user units/s ²]
Jerk	INPUT	REAL	Parameter is currently not supported; call with 0.0
Done	OUTPUT	BOOL	<ul style="list-style-type: none"> ■ Status <ul style="list-style-type: none"> – TRUE: Job successfully done
Busy	OUTPUT	BOOL	<ul style="list-style-type: none"> ■ Status <ul style="list-style-type: none"> – TRUE: Job is running
CommandAborted	OUTPUT	BOOL	<ul style="list-style-type: none"> ■ Status <ul style="list-style-type: none"> – TRUE: The job was aborted during processing by another job.
Error	OUTPUT	BOOL	<ul style="list-style-type: none"> ■ Status <ul style="list-style-type: none"> – TRUE: An error has occurred. Additional error information can be found in the parameter <i>ErrorID</i>.
ErrorID	OUTPUT	WORD	Additional error information ↪ Chap. 13.10 'ErrorID - Additional error information' page 637

PLCopen-State

- Start of the job in the PLCopen-States *Standstill*, *Homing*, *Discrete Motion* and *Continuous Motion* possible.
- MC_Stop switches the axis to the PLCopen-State *Stopping*. In *Stopping* no motion jobs can be started. As long as *Execute* is true, the axis remains in PLCopen-State *Stopping*. If *Execute* becomes FALSE, the axis switches to PLCopen-State *Standstill*. In *Standstill* motion tasks can be started.

Stop axis

The stopping of the axis is started with an edge 0-1 at *Execute*. *Busy* is TRUE as soon as the stopping of the axis is running. After the axis has been stopped and thus the speed has reached 0, *Busy* with FALSE and *Done* with TRUE is returned.



- An active job continues until the axis stops even when *Execute* is set to FALSE.
- A running job can not be aborted by a move job (e.g. *MC_MoveRelative*).

Status diagram of the block parameters

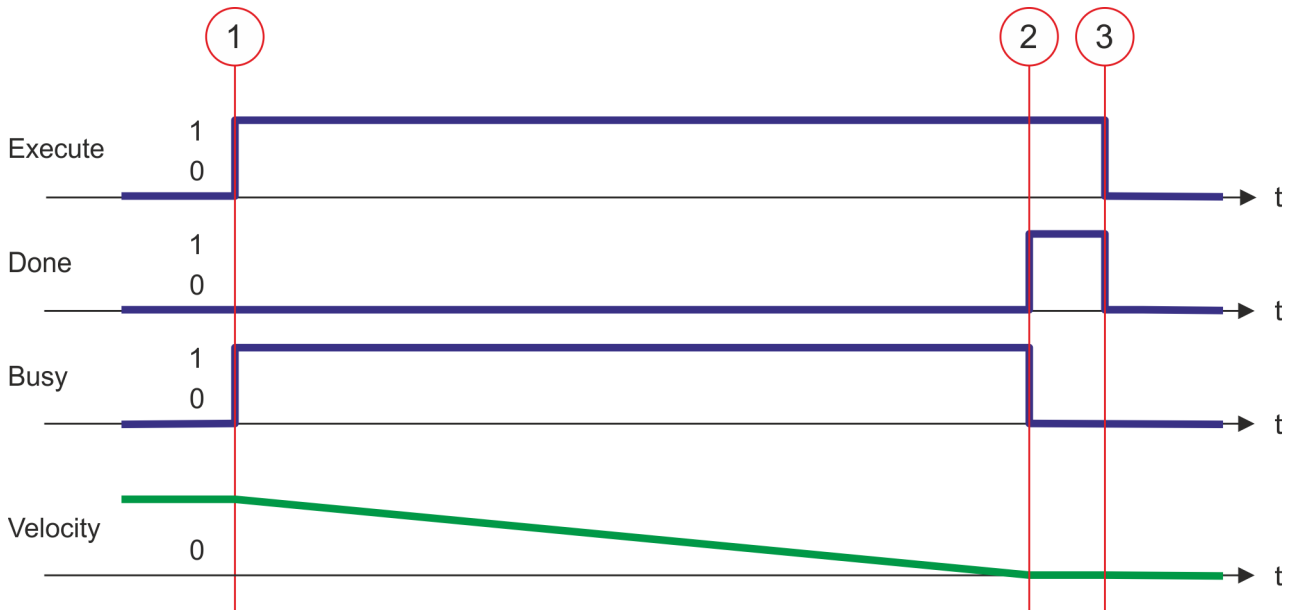

- (1) Stopping of the axis is started with edge 0-1 at *Execute* and *Busy* becomes TRUE. The velocity of the axis is reduced to zero, regarding the parameter *Deceleration*.
- (2) At time (2) stopping the axis is completed, the axis is stopped. *Busy* has the value FALSE and *Done* den value TRUE.
- (3) At the time (3) the job is completed and *Execute* becomes FALSE and thus each output parameter FALSE respectively 0.

13.7.3.6 FB 803 - MC_Halt - holding axis

Description



An overview of the drive systems, which can be controlled with this block can be found here: [Chap. 13.7.1 'Overview' page 542](#)

With MC_Halt the axis is slowed down to standstill. With the parameter *Deceleration* the dynamic behavior can be determined during breaking.

Parameter

Parameter	Declaration	Data type	Description
Axis	IN_OUT	MC_AXIS_REF	Reference to the axis
Execute	INPUT	BOOL	<ul style="list-style-type: none"> ■ Stop axis <ul style="list-style-type: none"> – Edge 0-1: Stopping of the axis is started
Deceleration	INPUT	REAL	Delay in breaking in [user units/s ²]
Jerk	INPUT	REAL	Parameter is currently not supported; call with 0.0
BufferMode	INPUT	BYTE	Parameter is currently not supported; call with B#16#0
Done	OUTPUT	BOOL	<ul style="list-style-type: none"> ■ Status <ul style="list-style-type: none"> – TRUE: Job successfully done
Busy	OUTPUT	BOOL	<ul style="list-style-type: none"> ■ Status <ul style="list-style-type: none"> – TRUE: Job is running
Active	OUTPUT	BOOL	<ul style="list-style-type: none"> ■ Status <ul style="list-style-type: none"> – TRUE: Block controls the axis
CommandA-borted	OUTPUT	BOOL	<ul style="list-style-type: none"> ■ Status <ul style="list-style-type: none"> – TRUE: The job was aborted during processing by another job
Error	OUTPUT	BOOL	<ul style="list-style-type: none"> ■ Status <ul style="list-style-type: none"> – TRUE: An error has occurred. Additional error information can be found in the parameter <i>ErrorID</i>.
ErrorID	OUTPUT	WORD	Additional error information Chap. 13.10 'ErrorID - Additional error information' page 637

PLCopen-State

- Start of the job in the PLCopen-States *Discrete Motion* and *Continuous Motion* possible.
- MC_Halt switches the axis to the PLCopen-State *Discrete Motion*.

Slow down axis

The slow down of the axis is started with an edge 0-1 at *Execute*. *Busy* is TRUE as soon as the slow down of the axis is running. After the axis has been slowed down and thus the speed has reached 0, *Busy* with FALSE and *Done* with TRUE is returned.



- An active job continues until the axis stops even when *Execute* is set to FALSE.
- A running job can be aborted by a move job (e.g. MC_MoveRelative).

Status diagram of the block parameters

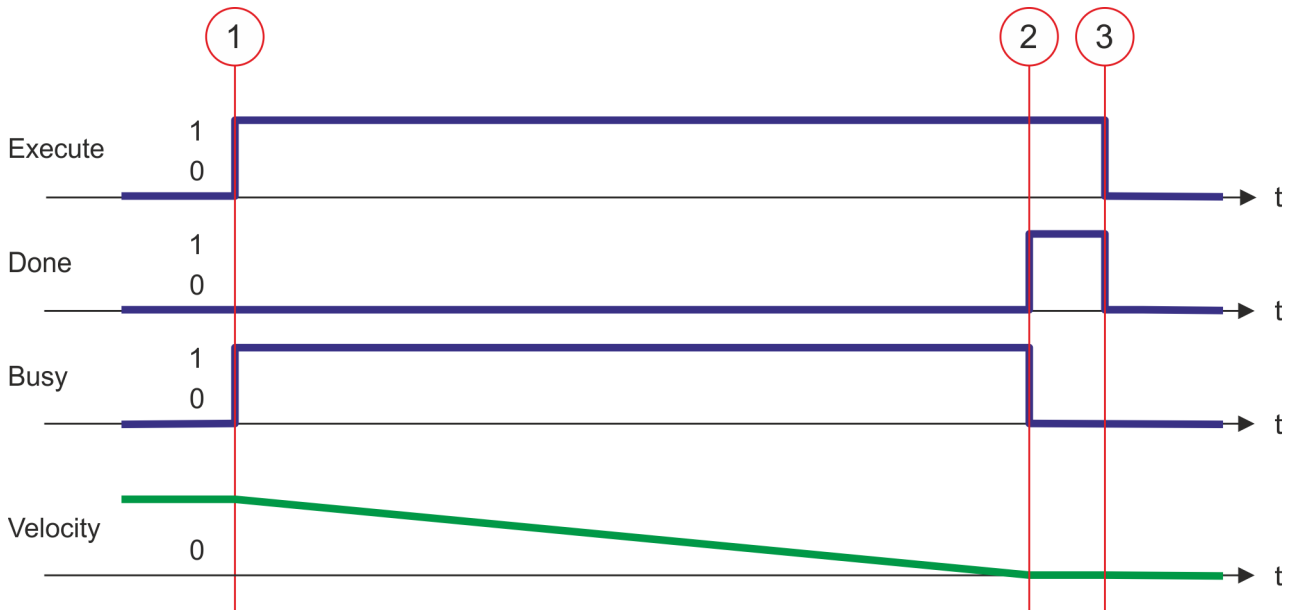

- (1) Breaking the axis is started with edge 0-1 at *Execute* and *Busy* becomes TRUE. The velocity of the axis is reduced to zero, regarding the parameter *Deceleration*.
- (2) At time (2) slowing down the axis is completed, the axis is stopped. *Busy* has the value FALSE and *Done* den value TRUE.
- (3) At the time (3) the job is completed and *Execute* becomes FALSE and thus each output parameter FALSE respectively 0.

13.7.3.7 FB 804 - MC_MoveRelative - move axis relative

Description



An overview of the drive systems, which can be controlled with this block can be found here: [Chap. 13.7.1 'Overview' page 542](#)

With MC_MoveRelative the axis is moved relative to the position in order to start a specified distance. With the parameters *Velocity*, *Acceleration* and *Deceleration* the dynamic behavior can be determined during the movement.

Parameter

Parameter	Declaration	Data type	Description
Axis	IN_OUT	MC_AXIS_REF	Reference to the axis
Execute	INPUT	BOOL	<ul style="list-style-type: none"> ■ Move axis relative <ul style="list-style-type: none"> – Edge 0-1: The relative movement of the axis is started
ContinuousUpdate	INPUT	BOOL	Parameter is currently not supported; call with FALSE
Distance	INPUT	REAL	Relative distance in [user units]
Velocity	INPUT	REAL	Max. Velocity (needs not necessarily be reached) in [user units/s]
Acceleration	INPUT	REAL	Acceleration in [user units/s ²]
Deceleration	INPUT	REAL	Delay in breaking in [user units/s ²]
Jerk	INPUT	REAL	Parameter is currently not supported; call with 0.0
BufferMode	INPUT	BYTE	Parameter is currently not supported; call with B#16#0
Done	OUTPUT	BOOL	<ul style="list-style-type: none"> ■ Status <ul style="list-style-type: none"> – TRUE: Job successfully done; target position reached
Busy	OUTPUT	BOOL	<ul style="list-style-type: none"> ■ Status <ul style="list-style-type: none"> – TRUE: Job is running
Active	OUTPUT	BOOL	<ul style="list-style-type: none"> ■ Status <ul style="list-style-type: none"> – TRUE: Block controls the axis
CommandAborted	OUTPUT	BOOL	<ul style="list-style-type: none"> ■ Status <ul style="list-style-type: none"> – TRUE: The job was aborted during processing by another job
Error	OUTPUT	BOOL	<ul style="list-style-type: none"> ■ Status <ul style="list-style-type: none"> – TRUE: An error has occurred. Additional error information can be found in the parameter <i>ErrorID</i>.
ErrorID	OUTPUT	WORD	Additional error information Chap. 13.10 'ErrorID - Additional error information' page 637

PLCopen-State

- Start of the job in the PLCopen-States *Standstill*, *Discrete Motion* and *Continuous Motion* possible.
- MC_MoveRelative switches the axis to the PLCopen-State *Discrete Motion*.

Move axis relative

The movement of the axis is started with an edge 0-1 at *Execute*. *Busy* is TRUE as soon as the movement of the axis is running. After the target position was reached, *Busy* with FALSE and *Done* with TRUE is returned. Then the velocity of the axis is 0.



- An active job continues to move to target position even when *Execute* is set to FALSE.
- A running job can be aborted by a move job (e.g. MC_MoveAbsolute).

Status diagram of the block parameters

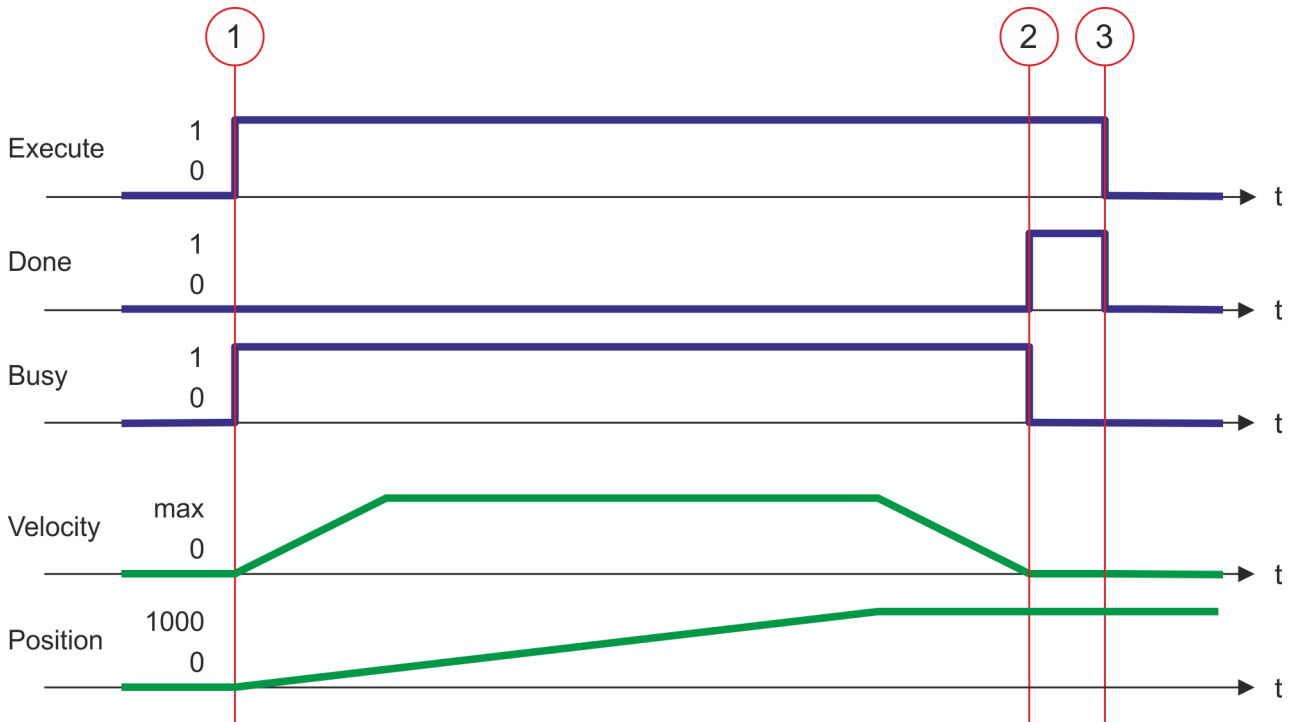

- (1) With MC_MoveRelative the axis is moved relative by a *Distance* = 1000.0 (start position at job start is 0.0). Moving the axis is started with edge 0-1 at *Execute* and *Busy* becomes TRUE.
- (2) At time (2) the axis was moved by the *Distance* = 1000.0, i.e. the target position was reached. *Busy* has the value FALSE and *Done* den value TRUE.
- (3) At the time (3) the job is completed and *Execute* becomes FALSE and thus each output parameter FALSE respectively 0.

13.7.3.8 FB 805 - MC_MoveVelocity - drive axis with constant velocity

Description



An overview of the drive systems, which can be controlled with this block can be found here: [Chap. 13.7.1 'Overview' page 542](#)

With MC_MoveVelocity the axis is driven with a constant velocity. With the parameters *Velocity*, *Acceleration* and *Deceleration* the dynamic behavior can be determined during the movement.

Parameter

Parameter	Declaration	Data type	Description
Axis	IN_OUT	MC_AXIS_REF	Reference to the axis
Execute	INPUT	BOOL	<ul style="list-style-type: none"> ■ Drive axis with constant velocity <ul style="list-style-type: none"> – Edge 0-1: Drive axis with constant velocity is started
ContinuousUpdate	INPUT	BOOL	Parameter is currently not supported; call with FALSE
Velocity	INPUT	REAL	Velocity setting (signed value) in [user units/s]
Acceleration	INPUT	REAL	Acceleration in [user units/s ²]
Deceleration	INPUT	REAL	Delay in breaking in [user units/s ²]
Jerk	INPUT	REAL	Parameter is currently not supported; call with 0.0
BufferMode	INPUT	BYTE	Parameter is currently not supported; call with B#16#0
InVelocity	OUTPUT	BOOL	<ul style="list-style-type: none"> ■ Velocity setting <ul style="list-style-type: none"> – TRUE: Velocity setting reached
Busy	OUTPUT	BOOL	<ul style="list-style-type: none"> ■ Status <ul style="list-style-type: none"> – TRUE: Job is running
Active	OUTPUT	BOOL	<ul style="list-style-type: none"> ■ Status <ul style="list-style-type: none"> – TRUE: Block controls the axis
CommandAborted	OUTPUT	BOOL	<ul style="list-style-type: none"> ■ Status <ul style="list-style-type: none"> – TRUE: The job was aborted during processing by another job
Error	OUTPUT	BOOL	<ul style="list-style-type: none"> ■ Status <ul style="list-style-type: none"> – TRUE: An error has occurred. Additional error information can be found in the parameter <i>ErrorID</i>.
ErrorID	OUTPUT	WORD	Additional error information Chap. 13.10 'ErrorID - Additional error information' page 637

PLCopen-State

- Start of the job in the PLCopen-States *Standstill*, *Discrete Motion* and *Continuous Motion* possible.
- MC_MoveVelocity switches the axis to the PLCopen-State *Continuous Motion*.

Drive axis with set velocity

The movement of the axis with set velocity is started with an edge 0-1 at *Execute*. *Busy* is TRUE and *InVelocity* FALSE as soon as the set velocity is not reached. If the set velocity is reached, *Busy* becomes FALSE and *InVelocity* TRUE. The axis is constant moved with this velocity.



- An active job is continued, even when the set velocity is reached and even when *Execute* is set to FALSE.
- A running job can be aborted by a move job (e.g. *MC_MoveAbsolute*).

Status diagram of the block parameters

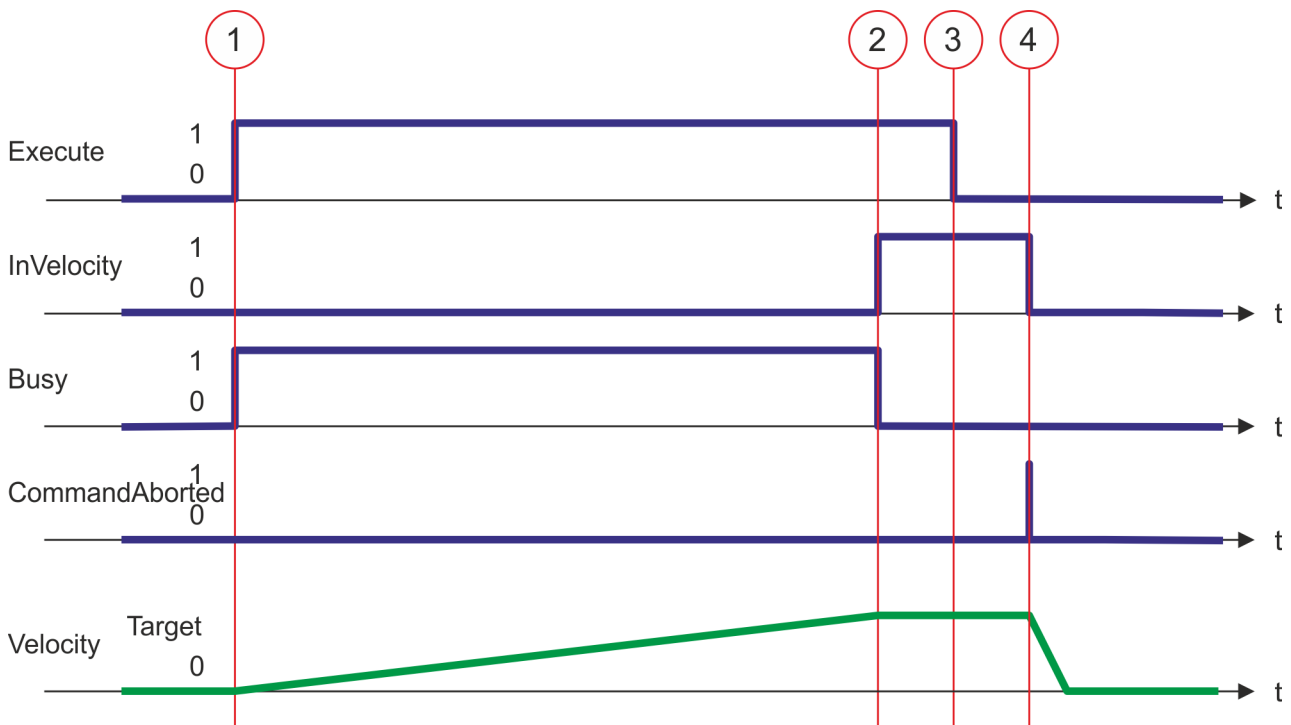

- (1) Moving the axis with set velocity is started with edge 0-1 at *Execute* and *Busy* becomes TRUE.
- (2) At time (2) the axis reaches the set velocity and *Busy* has the value FALSE and *InVelocity* the value TRUE.
- (3) Resetting *Execute* to FALSE at time (3) does not influence the axis. The axis is further moved with constant set velocity and *InVelocity* is further TRUE.
- (4) At the time (4) the *MC_Velocity* job is aborted by a *MC_Halt* job. The axis is decelerated to stop.

13.7.3.9 FB 808 - MC_MoveAbsolute - move axis to absolute position

Description



An overview of the drive systems, which can be controlled with this block can be found here: [Chap. 13.7.1 'Overview' page 542](#)

With MC_MoveAbsolute the axis is moved to an absolute position. With the parameters *Velocity*, *Acceleration* and *Deceleration* the dynamic behavior can be determined during the movement.

Parameter

Parameter	Declaration	Data type	Description
Axis	IN_OUT	MC_AXIS_REF	Reference to the axis
Execute	INPUT	BOOL	<ul style="list-style-type: none"> ■ Move the axis <ul style="list-style-type: none"> – Edge 0-1: The movement of the axis is started
ContinuousUpdate	INPUT	BOOL	Parameter is currently not supported; call with FALSE
Position	INPUT	REAL	Absolute position in [user units]
Velocity	INPUT	REAL	Maximum velocity (needs not necessarily be reached) signed value in [user units/s]
Acceleration	INPUT	REAL	Acceleration in [user units/s ²]
Deceleration	INPUT	REAL	Delay in breaking in [user units/s ²]
Jerk	INPUT	REAL	Parameter is currently not supported; call with 0.0
Direction	INPUT	Byte	<ul style="list-style-type: none"> ■ Direction <ul style="list-style-type: none"> – 0: Shortest way – 1: Positive direction – 2: Negative direction – 3: Current direction
BufferMode	INPUT	BYTE	Parameter is currently not supported; call with B#16#0
Done	OUTPUT	BOOL	<ul style="list-style-type: none"> ■ Status <ul style="list-style-type: none"> – TRUE: Job successfully done. Target position was reached.
Busy	OUTPUT	BOOL	<ul style="list-style-type: none"> ■ Status <ul style="list-style-type: none"> – TRUE: Job is running
Active	OUTPUT	BOOL	<ul style="list-style-type: none"> ■ Status <ul style="list-style-type: none"> – TRUE: Block controls the axis
CommandAborted	OUTPUT	BOOL	<ul style="list-style-type: none"> ■ Status <ul style="list-style-type: none"> – TRUE: The job was aborted during processing by another job
Error	OUTPUT	BOOL	<ul style="list-style-type: none"> ■ Status <ul style="list-style-type: none"> – TRUE: An error has occurred. Additional error information can be found in the parameter <i>ErrorID</i>.
ErrorID	OUTPUT	WORD	Additional error information Chap. 13.10 'ErrorID - Additional error information' page 637

PLCopen-State

- Start of the job in the PLCopen-States *Standstill*, *Discrete Motion* and *Continuous Motion* possible.
- MC_MoveVelocity switches the axis to the PLCopen-State *Discrete Motion*.

Move axis absolute

The movement of the axis is started with an edge 0-1 at *Execute*. *Busy* is TRUE as soon as the movement of the axis is running. After the target position was reached, *Busy* with FALSE and *Done* with TRUE is returned. Then the velocity of the axis is 0.



- With Sigma-5 EtherCAT the target position is always reached via the shortest way.
- An active job continues to move to target position even when *Execute* is set to FALSE.
- A running job can be aborted by a move job (e.g. MC_MoveVelocity).

Status diagram of the block parameters

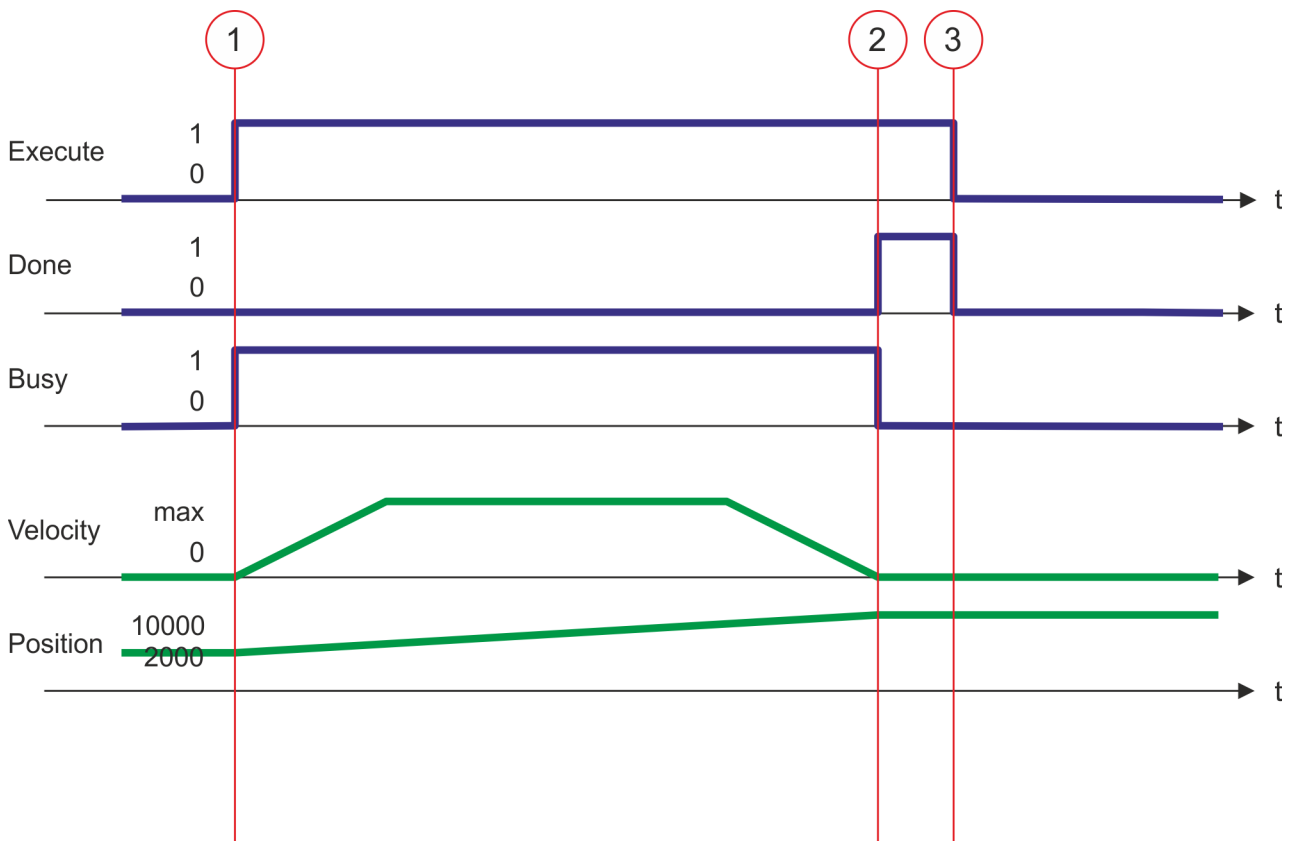

- (1) With MC_MoveAbsolute the axis is moved to the absolute position = 10000.0 (start position at job start is 2000.0). At time (1) moving the axis is started with edge 0-1 at *Execute* and *Busy* becomes TRUE.
- (2) At time (2) the axis has reached the target position. *Busy* has the value FALSE and *Done* den value TRUE.
- (3) At the time (3) the job is completed and *Execute* becomes FALSE and thus each output parameter FALSE respectively 0.

13.7.3.10 FB 811 - MC_Reset - reset axis

Description



An overview of the drive systems, which can be controlled with this block can be found here: [↗ Chap. 13.7.1 'Overview' page 542](#)

With MC_Reset a reset (reinitialize) of the axis is done. Here all the internal errors are reset.

Parameter

Parameter	Declaration	Data type	Description
Axis	IN_OUT	MC_AXIS_REF	Reference to the axis
Execute	INPUT	BOOL	<ul style="list-style-type: none"> Reset axis <ul style="list-style-type: none"> Edge 0-1: Axis reset is performed
Done	OUTPUT	BOOL	<ul style="list-style-type: none"> Status <ul style="list-style-type: none"> TRUE: Job successfully done. Reset was performed
Busy	OUTPUT	BOOL	<ul style="list-style-type: none"> Status <ul style="list-style-type: none"> TRUE: Job is running
Error	OUTPUT	BOOL	<ul style="list-style-type: none"> Status <ul style="list-style-type: none"> TRUE: An error has occurred. Additional error information can be found in the parameter <i>ErrorID</i>.
ErrorID	OUTPUT	WORD	Additional error information ↗ Chap. 13.10 'ErrorID - Additional error information' page 637

PLCopen-State

- Job start in PLCopen-State *ErrorStop* possible.
- MC_Reset switches the axis depending on MC_Power either to PLCopen-State *Standstill* (call MC_Power with *Enable* = TRUE) or *Disabled* (call MC_Power with *Enable* = FALSE).

Perform reset on axis

The reset of the axis is started with an edge 0-1 at *Execute*. *Busy* is TRUE as soon as the reset of the axis is running. After axis has been reinitialized, *Busy* with FALSE and *Done* with TRUE is returned.



An active job continues until it is finished even when *Execute* is set to FALSE.

Status diagram of the block parameters

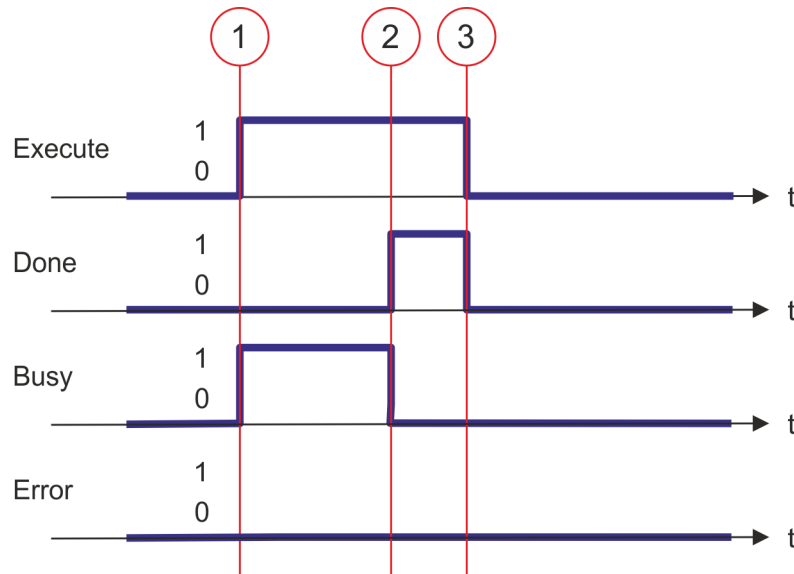

- (1) At time (1) the reset of the axis is started with edge 0-1 at *Execute* and *Busy* becomes TRUE.
- (2) At the time (2) the reset is successfully completed. *Busy* has the value FALSE and *Done* den value TRUE.
- (3) At the time (3) the job is completed and *Execute* becomes FALSE and thus each output parameter FALSE respectively 0.

13.7.3.11 FB 812 - MC_ReadStatus - PLCopen status

Description



An overview of the drive systems, which can be controlled with this block can be found here: [Chap. 13.7.1 'Overview' page 542](#)

With MC_ReadStatus the PLCopen-State of the axis can be determined

Parameter

Parameter	Declaration	Data type	Description
Axis	IN_OUT	MC_AXIS_REF	Reference to the slave axis
Enable	INPUT	BOOL	<ul style="list-style-type: none"> ■ Status indication <ul style="list-style-type: none"> – TRUE: The status is permanently displayed at the outputs – FALSE: All the outputs are FALSE respectively 0
Valid	OUTPUT	BOOL	<ul style="list-style-type: none"> ■ State is valid <ul style="list-style-type: none"> – TRUE: The shown state is valid
Error	OUTPUT	BOOL	<ul style="list-style-type: none"> ■ Status <ul style="list-style-type: none"> – TRUE: An error has occurred. Additional error information can be found in the parameter <i>ErrorID</i>.
ErrorID	OUTPUT	WORD	Additional error information Chap. 13.10 'ErrorID - Additional error information' page 637
ErrorStop	OUTPUT	BOOL	<ul style="list-style-type: none"> ■ Axis errors <ul style="list-style-type: none"> – TRUE: An axis error has occurred, move job can not be activated
Disabled	OUTPUT	BOOL	<ul style="list-style-type: none"> ■ Status axis: Disabled <ul style="list-style-type: none"> – TRUE: Axis is disabled, move job can not be activated
Stopping	OUTPUT	BOOL	<ul style="list-style-type: none"> ■ Status axis: Stop <ul style="list-style-type: none"> – TRUE: Axis is stopped (MC_Stop is active)
Homing	OUTPUT	BOOL	<ul style="list-style-type: none"> ■ Status axis: Homing <ul style="list-style-type: none"> – TRUE: Axis is just homing (MC_Homing is active)
Standstill	OUTPUT	BOOL	<ul style="list-style-type: none"> ■ Status move job <ul style="list-style-type: none"> – TRUE: No move job is active; a move job can be activated
DiscreteMotion	OUTPUT	BOOL	<ul style="list-style-type: none"> ■ Status axis motion: Discrete <ul style="list-style-type: none"> – TRUE: Axis is moved by a discrete movement (MC_MoveRelative, MC_MoveAbsolute or MC_Halt is active)
ContinuousMotion	OUTPUT	BOOL	<ul style="list-style-type: none"> ■ Status axis motion: Continuous <ul style="list-style-type: none"> – TRUE: Axis is moved by a continuous movement (MC_MoveVelocity is active)

PLCopen-State

- Job start in each PLCopen-State possible.

Determine the status of the axis

With *Enable* = TRUE the outputs represent the state of the axis according to the PLCopen-State diagram.

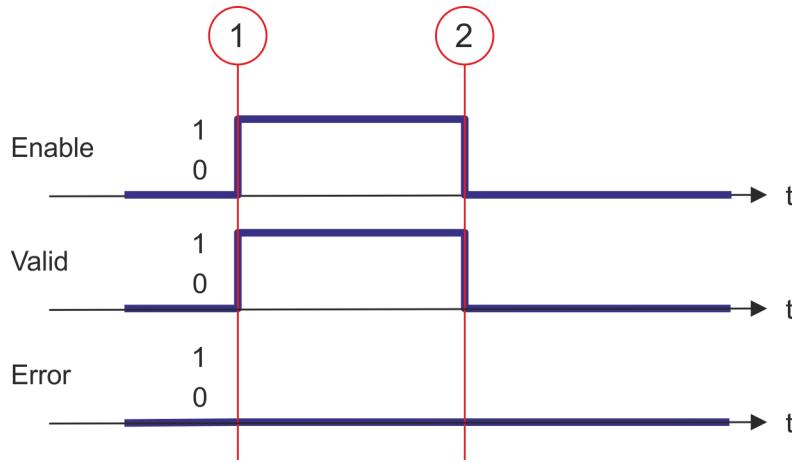
Status diagram of the block parameters

- (1) At time (1) *Enable* is set to TRUE. So *Valid* gets TRUE and the outputs correspond to the status of the PLCopen-State.
- (2) At time (2) *Enable* is set to FALSE. So all the outputs are set to FALSE respectively 0.

13.7.3.12 FB 813 - MC_ReadAxisError - read axis error

Description



An overview of the drive systems, which can be controlled with this block can be found here: [Chap. 13.7.1 'Overview' page 542](#)

With MC_ReadAxisError the current error of the axis is directly be read.

Parameter

Parameter	Declaration	Data type	Description
Axis	IN_OUT	MC_AXIS_REF	Reference to the axis
Execute	INPUT	BOOL	<ul style="list-style-type: none"> ■ Reset axis <ul style="list-style-type: none"> – Edge 0-1: Axis error is read.
Done	OUTPUT	BOOL	<ul style="list-style-type: none"> ■ Status <ul style="list-style-type: none"> – TRUE: Job successfully done. Axis error read.
Busy	OUTPUT	BOOL	<ul style="list-style-type: none"> ■ Status <ul style="list-style-type: none"> – TRUE: Job is running.
Error	OUTPUT	BOOL	<ul style="list-style-type: none"> ■ Status <ul style="list-style-type: none"> – TRUE: An error has occurred. Additional error information can be found in the parameter <i>ErrorID</i>.
ErrorID	OUTPUT	WORD	Additional error information Chap. 13.10 'ErrorID - Additional error information' page 637
AxisErrorID	OUTPUT	WORD	Axis error ID; the read value is vendor-specifically encoded.

PLCopen-State

- Job start in each PLCopen-State possible.

Read error of the axis

The reading of the error of the axis is started with an edge 0-1 at *Execute*. *Busy* is TRUE as soon as reading of the axis error is running. After the axis error was read, *Busy* with FALSE and *Done* with TRUE is returned. The output *AxisErrorID* shows the current axis error.



An active job continues to run even when *Execute* is set to FALSE.

Status diagram of the block parameters

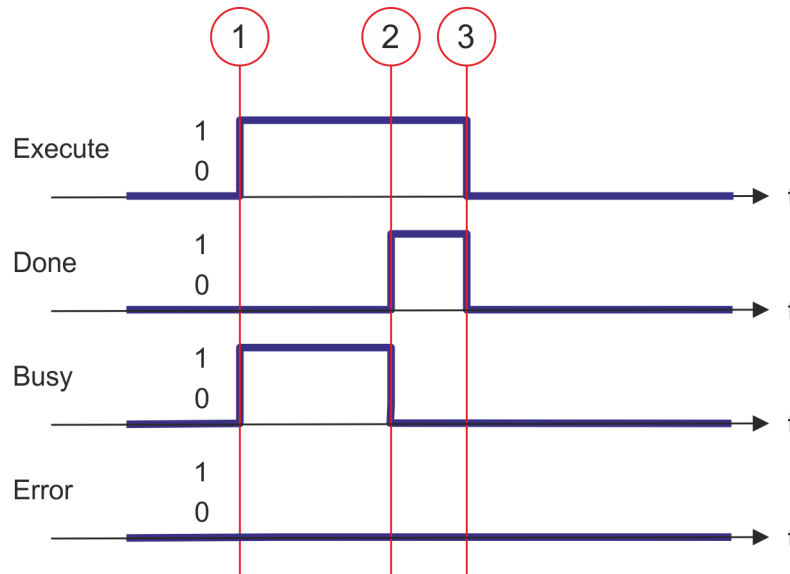

- (1) At time (1) the reading of the axis error is started with edge 0-1 at *Execute* and *Busy* becomes TRUE.
- (2) At the time (2) reading of the axis error is successfully completed. *Busy* has the value FALSE and *Done* den value TRUE.
- (3) At the time (3) the job is completed and *Execute* becomes FALSE and thus each output parameter FALSE respectively 0.

13.7.3.13 FB 814 - MC_ReadParameter - read axis parameter data

Description



An overview of the drive systems, which can be controlled with this block can be found here: [↪ Chap. 13.7.1 'Overview' page 542](#)

With MC_ReadParameter the parameter, that is defined by the parameter number, is read from the axis. [↪ Chap. 13.7.3.35 'PLCopen parameter' page 611](#)

Parameter

Parameter	Declaration	Data type	Description
Axis	IN_OUT	MC_AXIS_REF	Reference to the axis
Execute	INPUT	BOOL	<ul style="list-style-type: none"> ■ Read axis parameter data <ul style="list-style-type: none"> – Edge 0-1: The parameter data is read
Parameter Number	INPUT	INT	Number of the parameter to be read. ↪ Chap. 13.7.3.35 'PLCopen parameter' page 611
Done	OUTPUT	BOOL	<ul style="list-style-type: none"> ■ Status <ul style="list-style-type: none"> – TRUE: Job successfully done. Parameter data was read
Busy	OUTPUT	BOOL	<ul style="list-style-type: none"> ■ Status <ul style="list-style-type: none"> – TRUE: Job is running
Error	OUTPUT	BOOL	<ul style="list-style-type: none"> ■ Status <ul style="list-style-type: none"> – TRUE: An error has occurred. Additional error information can be found in the parameter <i>ErrorID</i>.
ErrorID	OUTPUT	WORD	Additional error information ↪ Chap. 13.10 'ErrorID - Additional error information' page 637
Value	OUTPUT	REAL	Value of the read parameter

PLCopen-State

- Job start in each PLCopen-State possible.

Read axis parameter data

The reading of the axis parameter data is started with an edge 0-1 at *Execute*. *Busy* is TRUE as soon as reading of parameter data is running. After the parameter data was read, *Busy* with FALSE and *Done* with TRUE is returned. The output *Value* shows the value of the parameter.

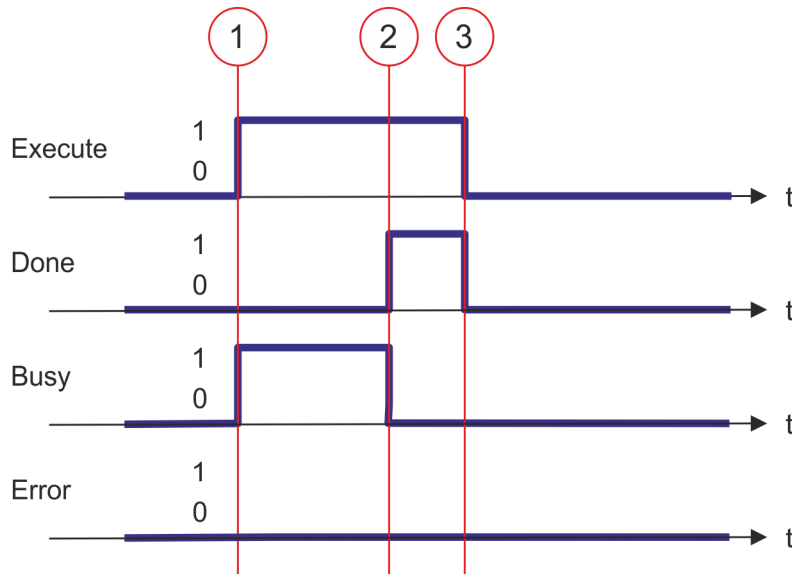

An active job continues to run even when *Execute* is set to FALSE.

Status diagram of the block parameters

- (1) At time (1) the reading of the parameter data is started with edge 0-1 at *Execute* and *Busy* becomes TRUE.
- (2) At the time (2) reading of the parameter data is successfully completed. *Busy* has the value FALSE and *Done* den value TRUE.
- (3) At the time (3) the job is completed and *Execute* becomes FALSE and thus each output parameter FALSE respectively 0.

13.7.3.14 FB 815 - MC_WriteParameter - write axis parameter data

Description



An overview of the drive systems, which can be controlled with this block can be found here: [Chap. 13.7.1 'Overview' page 542](#)

With MC_WriteParameter the value of the parameter, that is defined by the parameter number, is written to the axis. [Chap. 13.7.3.35 'PLCopen parameter' page 611](#)

Parameter

Parameter	Declaration	Data type	Description
Axis	IN_OUT	MC_AXIS_REF	Reference to the axis
Execute	INPUT	BOOL	<ul style="list-style-type: none"> ■ Write axis parameter data <ul style="list-style-type: none"> – Edge 0-1: The parameter data is written
Parameter Number	INPUT	INT	Number of the parameter to be written. Chap. 13.7.3.35 'PLCopen parameter' page 611
Value	INPUT	REAL	Value of the written parameter
Done	OUTPUT	BOOL	<ul style="list-style-type: none"> ■ Status <ul style="list-style-type: none"> – TRUE: Job successfully done. Parameter data was written
Busy	OUTPUT	BOOL	<ul style="list-style-type: none"> ■ Status <ul style="list-style-type: none"> – TRUE: Job is running
Error	OUTPUT	BOOL	<ul style="list-style-type: none"> ■ Status <ul style="list-style-type: none"> – TRUE: An error has occurred. Additional error information can be found in the parameter <i>ErrorID</i>.
ErrorID	OUTPUT	WORD	Additional error information Chap. 13.10 'ErrorID - Additional error information' page 637

PLCopen-State

- Job start in each PLCopen-State possible.

Write axis parameter data

The writing of the axis parameter data is started with an edge 0-1 at *Execute*. *Busy* is TRUE as soon as writing of parameter data is running. After the parameter data was written, *Busy* with FALSE and *Done* with TRUE is returned.

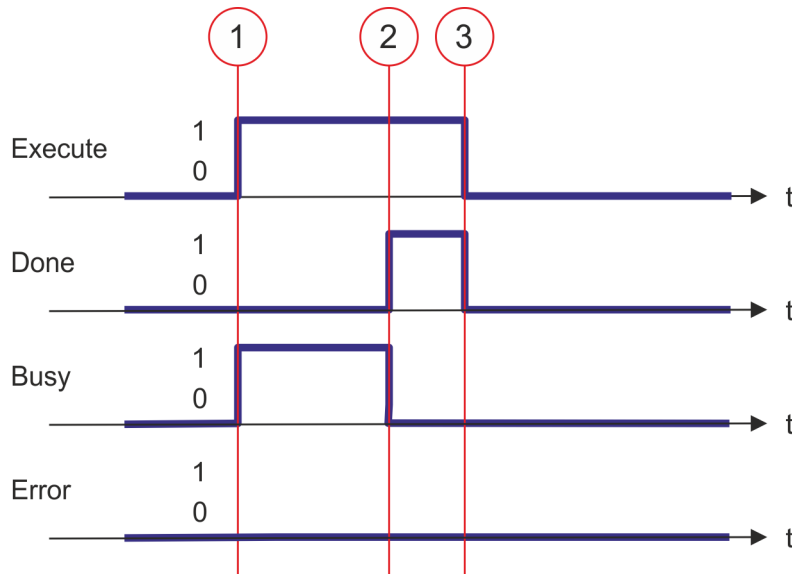

An active job continues to run even when *Execute* is set to FALSE.

Status diagram of the block parameters

- (1) At time (1) the writing of the parameter data is started with edge 0-1 at *Execute* and *Busy* becomes TRUE.
- (2) At the time (2) writing of the parameter data is successfully completed. *Busy* has the value FALSE and *Done* den value TRUE.
- (3) At the time (3) the job is completed and *Execute* becomes FALSE and thus each output parameter FALSE respectively 0.

13.7.3.15 FB 816 - MC_ReadActualPosition - reading current axis position

Description



An overview of the drive systems, which can be controlled with this block can be found here: [Chap. 13.7.1 'Overview' page 542](#)

With MC_ReadActualPosition the current position of the axis is read.

Parameter

Parameter	Declaration	Data type	Description
Axis	IN_OUT	MC_AXIS_REF	Reference to the axis
Enable	INPUT	BOOL	<ul style="list-style-type: none"> ■ Read axis position <ul style="list-style-type: none"> – TRUE: The position of the axis is continuously read – FALSE: All the outputs are FALSE respectively 0
Valid	OUTPUT	BOOL	<ul style="list-style-type: none"> ■ Position valid <ul style="list-style-type: none"> – TRUE: The read position is valid
Error	OUTPUT	BOOL	<ul style="list-style-type: none"> ■ Status <ul style="list-style-type: none"> – TRUE: An error has occurred. Additional error information can be found in the parameter <i>ErrorID</i>.
ErrorID	OUTPUT	WORD	Additional error information Chap. 13.10 'ErrorID - Additional error information' page 637
Position	OUTPUT	REAL	Position of the axis [user unit]

PLCopen-State

- Job start in each PLCopen-State possible.

Read axis position

The current axis position is determined and stored at *Position* with *Enable* set to TRUE.

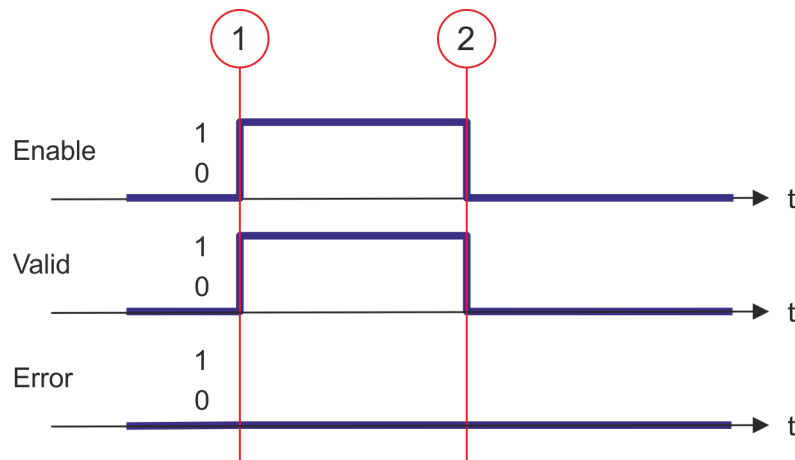
Status diagram of the block parameters

- (1) At time (1) *Enable* is set to TRUE. So *Valid* gets TRUE and output *Position* corresponds to the current axis position.
- (2) At time (2) *Enable* is set to FALSE. So all the outputs are set to FALSE respectively 0.

13.7.3.16 FB 817 - MC_ReadActualVelocity - read axis velocity

Description



An overview of the drive systems, which can be controlled with this block can be found here: [Chap. 13.7.1 'Overview' page 542](#)

With MC_ReadActualVelocity the current velocity of the axis is read.

Parameter

Parameter	Declaration	Data type	Description
Axis	IN_OUT	MC_AXIS_REF	Reference to the axis
Enable	INPUT	BOOL	<ul style="list-style-type: none"> ■ Read axis velocity <ul style="list-style-type: none"> – TRUE: The velocity of the axis is continuously read – FALSE: All the outputs are FALSE respectively 0
Valid	OUTPUT	BOOL	<ul style="list-style-type: none"> ■ Velocity valid <ul style="list-style-type: none"> – TRUE: The read velocity is valid
Error	OUTPUT	BOOL	<ul style="list-style-type: none"> ■ Status <ul style="list-style-type: none"> – TRUE: An error has occurred. Additional error information can be found in the parameter <i>ErrorID</i>.
ErrorID	OUTPUT	WORD	Additional error information Chap. 13.10 'ErrorID - Additional error information' page 637
Velocity	OUTPUT	REAL	Velocity of the axis [user unit/s]

PLCopen-State

- Job start in each PLCopen-State possible.

Read axis velocity

The current axis velocity is determined and stored at *Velocity* with *Enable* set to TRUE.

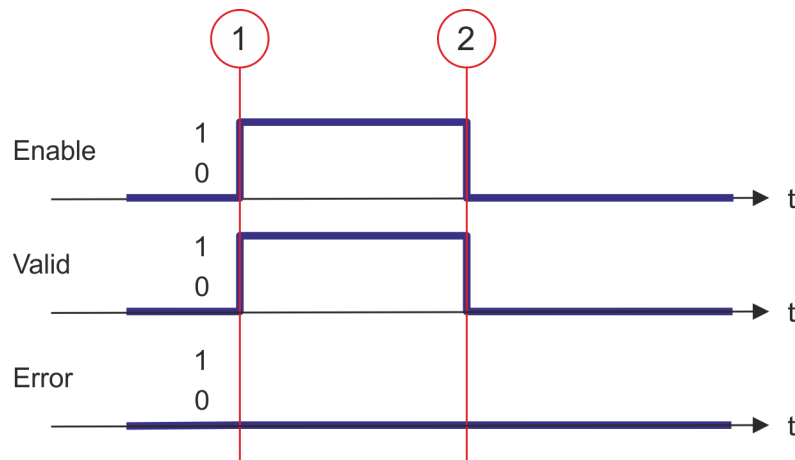
Status diagram of the block parameters

- (1) At time (1) *Enable* is set to TRUE. So *Valid* gets TRUE and output *Velocity* corresponds to the current axis velocity.
- (2) At time (2) *Enable* is set to FALSE. So all the outputs are set to FALSE respectively 0.

13.7.3.17 FB 818 - MC_ReadAxisInfo - read additional axis information

Description



An overview of the drive systems, which can be controlled with this block can be found here: [Chap. 13.7.1 'Overview' page 542](#)

With MC_ReadAxisInfo some additional information of the axis are shown.

Parameter

Parameter	Declaration	Data type	Description
Axis	IN_OUT	MC_AXIS_REF	Reference to the axis
Enable	INPUT	BOOL	<ul style="list-style-type: none"> ■ Read additional information from axis <ul style="list-style-type: none"> – TRUE: The additional information of the axis are read – FALSE: All the outputs are FALSE respectively 0
Valid	OUTPUT	BOOL	<ul style="list-style-type: none"> ■ Additional information valid <ul style="list-style-type: none"> – TRUE: The read additional information are valid
Error	OUTPUT	BOOL	<ul style="list-style-type: none"> ■ Status <ul style="list-style-type: none"> – TRUE: An error has occurred. Additional error information can be found in the parameter <i>ErrorID</i>.
ErrorID	OUTPUT	WORD	Additional error information Chap. 13.10 'ErrorID - Additional error information' page 637
HomeAbsSwitch	OUTPUT	BOOL	Homing switch <ul style="list-style-type: none"> ■ TRUE: Homing switch is activated
LimitSwitchPos	OUTPUT	BOOL	Limit switch positive direction <ul style="list-style-type: none"> ■ TRUE: Limit switch positive direction is activated
LimitSwitchNeg	OUTPUT	BOOL	Limit switch negative direction (NOT bit of the drive) <ul style="list-style-type: none"> ■ TRUE: Limit switch negative direction is activated
Simulation	OUTPUT	BOOL	Parameter is currently not supported; always FALSE
Communication-Ready	OUTPUT	BOOL	<ul style="list-style-type: none"> ■ Information axis: Data exchange <ul style="list-style-type: none"> – TRUE: Data exchange with axis is initialized; axis is ready for communication
ReadyForPowerOn	OUTPUT	BOOL	<ul style="list-style-type: none"> ■ Information axis: Enable possible <ul style="list-style-type: none"> – TRUE: Enabling the axis is possible
PowerOn	OUTPUT	BOOL	<ul style="list-style-type: none"> ■ Information axis: Enabled <ul style="list-style-type: none"> – TRUE: Enabling of the axis is carried out
IsHomed	OUTPUT	BOOL	<ul style="list-style-type: none"> ■ Information axis: Homed <ul style="list-style-type: none"> – TRUE: The axis is homed
AxisWarning	OUTPUT	BOOL	<ul style="list-style-type: none"> ■ Information axis: Error <ul style="list-style-type: none"> – TRUE: At least 1 error is reported from the axis

PLCopen-State

- Job start in each PLCopen-State possible.

Determine the status of the axis

The additional information of the axis are shown at the outputs with *Enable* set to TRUE.

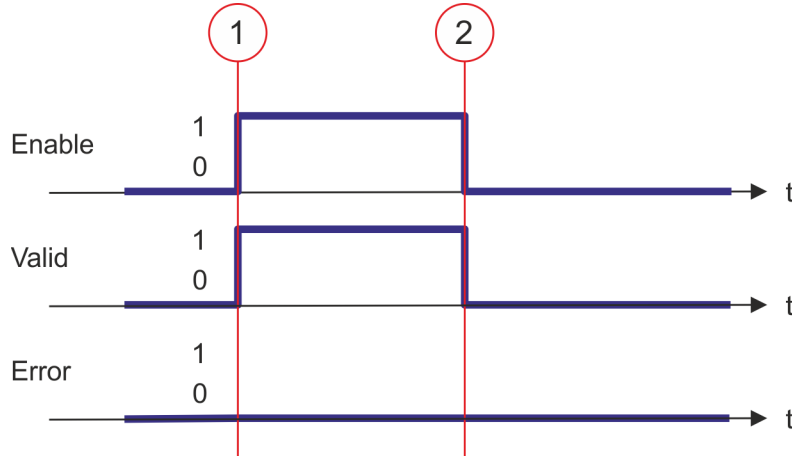
Status diagram of the block parameters

- (1) At time (1) *Enable* is set to TRUE. So *Valid* gets TRUE and the outputs show the additional information of the axis.
- (2) At time (2) *Enable* is set to FALSE. So all the outputs are set to FALSE respectively 0.

13.7.3.18 FB 819 - MC_ReadMotionState - read status motion job

Description



An overview of the drive systems, which can be controlled with this block can be found here: [Chap. 13.7.1 'Overview' page 542](#)

With MC_ReadMotionState the current status of the motion job is shown.

Parameter

Parameter	Declaration	Data type	Description
Axis	IN_OUT	MC_AXIS_REF	Reference to the axis
Enable	INPUT	BOOL	<ul style="list-style-type: none"> ■ Read motion state <ul style="list-style-type: none"> – TRUE: The status of the motion job is continuously read – FALSE: All the outputs are FALSE respectively 0
Source	INPUT	Byte	Only Source = 0 is supported; at the outputs the current status of the motion job is shown.
Valid	OUTPUT	BOOL	<ul style="list-style-type: none"> ■ Status valid <ul style="list-style-type: none"> – TRUE: The read status of the motion job is valid
Error	OUTPUT	BOOL	<ul style="list-style-type: none"> ■ Status <ul style="list-style-type: none"> – TRUE: An error has occurred. Additional error information can be found in the parameter <i>ErrorID</i>.
ErrorID	OUTPUT	WORD	Additional error information Chap. 13.10 'ErrorID - Additional error information' page 637
ConstantVelocity	OUTPUT	BOOL	<ul style="list-style-type: none"> ■ Status motion job: Velocity <ul style="list-style-type: none"> – TRUE: Velocity is constant
Accelerating	OUTPUT	BOOL	Please note that this parameter is not supported when using inverter drives via EtherCAT! <ul style="list-style-type: none"> ■ Status motion job: Acceleration <ul style="list-style-type: none"> – TRUE: The axis is accelerated; the velocity of the axis is increasing
Decelerating	OUTPUT	BOOL	Please note that this parameter is not supported when using inverter drives via EtherCAT! <ul style="list-style-type: none"> ■ Status motion job: Braking process <ul style="list-style-type: none"> – TRUE: Axis is decelerated; the velocity of the axis is getting smaller
DirectionPositive	OUTPUT	BOOL	<ul style="list-style-type: none"> ■ Status motion job: Position increasing <ul style="list-style-type: none"> – TRUE: The position of the axis is increasing
DirectionNegative	OUTPUT	BOOL	<ul style="list-style-type: none"> ■ Status motion job: Position decreasing <ul style="list-style-type: none"> – TRUE: The position of the axis is decreasing

PLCopen-State

- Job start in each PLCopen-State possible.

Read status of the motion job With *Enable* = TRUE the outputs represent the status of the motion job of the axis.

Status diagram of the block parameters

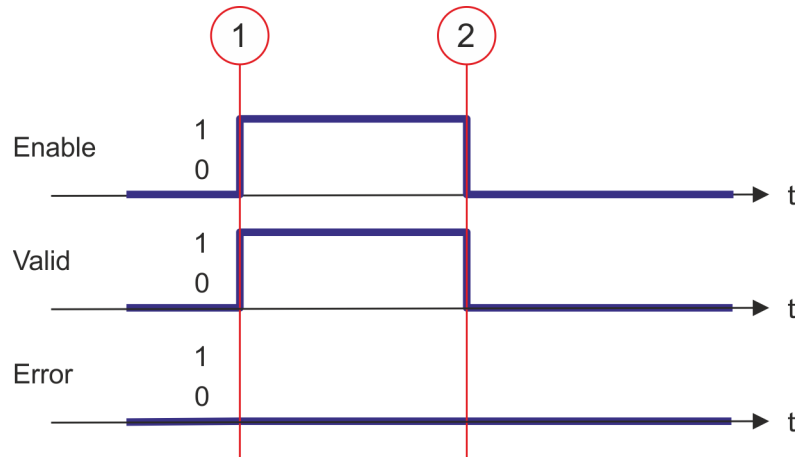

- (1) At time (1) *Enable* is set to TRUE. So *Valid* gets TRUE and the outputs correspond to the status of motion job.
- (2) At time (2) *Enable* is set to FALSE. So all the outputs are set to FALSE respectively 0.

13.7.3.19 FB 823 - MC_TouchProbe - record axis position

Description



An overview of the drive systems, which can be controlled with this block can be found here: [Chap. 13.7.1 'Overview' page 542](#)

This function block is used to record an axis position at a trigger event. The trigger signal can be configured via the variable specified at the input *TriggerInput*. As trigger signal can serve e.g. a digital input or a encoder zero track.

Parameter

Parameter	Declaration	Data type	Description
Axis	IN_OUT	MC_AXIS_REF	Reference to the axis.
TriggerInput	IN_OUT	MC_TRIGGER_REF	Reference to the trigger input. Structure <ul style="list-style-type: none"> ■ .Probe <ul style="list-style-type: none"> – 01: TouchProbe register 1 – 02: TouchProbe register 2 ■ .TriggerSource <ul style="list-style-type: none"> – 00: Input – 00: Encoder zero pulse ■ .Triggermode <ul style="list-style-type: none"> – 00: SingleTrigger (fix) ■ .Reserved (0 fix)
Execute	IN	BOOL	The recording of the axis position is activated with edge 0-1 at <i>Execute</i> .
Done	OUT	BOOL	■ Status <ul style="list-style-type: none"> – TRUE: Job successfully done. The axis position was recorded.
Busy	OUT	BOOL	■ Status <ul style="list-style-type: none"> – TRUE: Job is running.
CommandA-borted	OUT	BOOL	■ Status <ul style="list-style-type: none"> – TRUE: The job was aborted during processing by another job.
Error	OUT	BOOL	■ Status <ul style="list-style-type: none"> – TRUE: An error has occurred. Additional error information can be found in the parameter <i>ErrorID</i>.
ErrorID	OUT	WORD	Additional error information Chap. 13.10 'ErrorID - Additional error information' page 637
RecordedPosition	OUT	REAL	Recorded axis position where trigger event occurred [user units].



- An active job continues to run until this is completed, even when *Execute* is set to *FALSE*. The detected axis position is the output at *RecordedPosition* for one cycle. ↪ Chap. 13.9.3 'Behavior of the inputs and outputs' page 636
- Thus the job can be executed, the communication to the axis must be OK and the *PLCopen-State* must be unequal *Homing*.
- A running job can be aborted with a new *MC_TouchProbe* job for the same axis.
- A running job can be aborted by *MC_AbortTrigger*.
- A running job can be aborted by *MC_Home*.

Recording the axis position

The recording of the axis position is activated with edge 0-1 at *Execute*. *Busy* is TRUE as soon as the job is running. After processing the job, *Busy* with FALSE and *Done* with TRUE is returned. The recorded value can be found in *RecordedPosition*.

13.7.3.20 FB 824 - MC_AbortTrigger - abort recording axis position

Description



An overview of the drive systems, which can be controlled with this block can be found here: [↗ Chap. 13.7.1 'Overview' page 542](#)

This block aborts the recording of the axis position, which was started via MC_TouchProbe.

Parameter

Parameter	Declaration	Data type	Description
Axis	IN_OUT	MC_AXIS_REF	Reference to the axis.
TriggerInput	IN_OUT	MC_TRIGGER_REF	Reference to the trigger input. Structure <ul style="list-style-type: none"> ■ .Probe <ul style="list-style-type: none"> – 01: TouchProbe register 1 – 02: TouchProbe register 2 ■ .TriggerSource <ul style="list-style-type: none"> – 00: Input – 00: Encoder zero pulse ■ .Triggermode <ul style="list-style-type: none"> – 00: SingleTrigger (fix) ■ .Reserved (0 fix)
Execute	IN	BOOL	The recording of the axis position is aborted with edge 0-1 at <i>Execute</i> .
Done	OUT	BOOL	■ Status <ul style="list-style-type: none"> – TRUE: Job successfully done. The recording of the axis position was aborted.
Busy	OUT	BOOL	■ Status <ul style="list-style-type: none"> – TRUE: Job is running.
Error	OUT	BOOL	■ Status <ul style="list-style-type: none"> – TRUE: An error has occurred. Additional error information can be found in the parameter <i>ErrorID</i>.
ErrorID	OUT	WORD	Additional error information ↗ Chap. 13.10 'ErrorID - Additional error information' page 637



Thus the job can be executed, the communication to the axis must be OK.

Abort the recording of the axis position

The recording of the axis position is aborted with edge 0-1 at *Execute*. *Busy* is TRUE as soon as the job is running. After processing the job, *Busy* with FALSE and *Done* with TRUE is returned.

13.7.3.21 FB 825 - MC_ReadBoolParameter - read axis boolean parameter data

Description



An overview of the drive systems, which can be controlled with this block can be found here: [↪ Chap. 13.7.1 'Overview' page 542](#)

With MC_ReadBoolParameter the parameter of data type BOOL, that is defined by the parameter number, is read from the axis. [↪ Chap. 13.7.3.35 'PLCopen parameter' page 611](#)

Parameter

Parameter	Declaration	Data type	Description
Axis	IN_OUT	MC_AXIS_REF	Reference to the axis
Execute	INPUT	BOOL	<ul style="list-style-type: none"> Read axis parameter data <ul style="list-style-type: none"> Edge 0-1: The parameter data is read
Parameter Number	INPUT	INT	Number of the parameter to be read. ↪ Chap. 13.7.3.35 'PLCopen parameter' page 611
Done	OUTPUT	BOOL	<ul style="list-style-type: none"> Status <ul style="list-style-type: none"> TRUE: Job successfully done. Parameter data was read
Busy	OUTPUT	BOOL	<ul style="list-style-type: none"> Status <ul style="list-style-type: none"> TRUE: Job is running
Error	OUTPUT	BOOL	<ul style="list-style-type: none"> Status <ul style="list-style-type: none"> TRUE: An error has occurred. Additional error information can be found in the parameter <i>ErrorID</i>.
ErrorID	OUTPUT	WORD	Additional error information ↪ Chap. 13.10 'ErrorID - Additional error information' page 637
Value	OUTPUT	BOOL	Value of the read parameter

PLCopen-State

- Job start in each PLCopen-State possible.

Read axis parameter data

The reading of the axis parameter data is started with an edge 0-1 at *Execute*. *Busy* is TRUE as soon as reading of parameter data is running. After the parameter data was read, *Busy* with FALSE and *Done* with TRUE is returned. The output *Value* shows the value of the parameter.

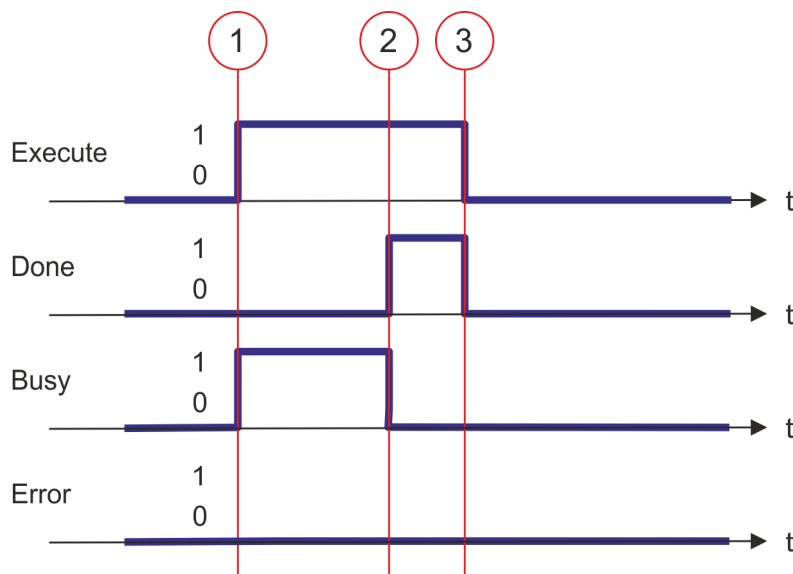

An active job continues to run even when *Execute* is set to FALSE.

Status diagram of the block parameters

- (1) At time (1) the reading of the parameter data is started with edge 0-1 at *Execute* and *Busy* becomes TRUE.
- (2) At the time (2) reading of the parameter data is successfully completed. *Busy* has the value FALSE and *Done* den value TRUE.
- (3) At the time (3) the job is completed and *Execute* becomes FALSE and thus each output parameter FALSE respectively 0.

13.7.3.22 FB 826 - MC_WriteBoolParameter - write axis boolean parameter data

Description



An overview of the drive systems, which can be controlled with this block can be found here: [Chap. 13.7.1 'Overview' page 542](#)

With MC_WriteBoolParameter the value of the parameter of data type BOOL, that is defined by the parameter number, is written to the axis. [Chap. 13.7.3.35 'PLCopen parameter' page 611](#)

Parameter

Parameter	Declaration	Data type	Description
Axis	IN_OUT	MC_AXIS_REF	Reference to the axis
Execute	INPUT	BOOL	<ul style="list-style-type: none"> ■ Write axis parameter data <ul style="list-style-type: none"> – Edge 0-1: The parameter data is written
Parameter Number	INPUT	INT	Number of the parameter to be written. Chap. 13.7.3.35 'PLCopen parameter' page 611
Value	INPUT	BOOL	Value of the written parameter
Done	OUTPUT	BOOL	<ul style="list-style-type: none"> ■ Status <ul style="list-style-type: none"> – TRUE: Job successfully done. Parameter data was written
Busy	OUTPUT	BOOL	<ul style="list-style-type: none"> ■ Status <ul style="list-style-type: none"> – TRUE: Job is running
Error	OUTPUT	BOOL	<ul style="list-style-type: none"> ■ Status <ul style="list-style-type: none"> – TRUE: An error has occurred. Additional error information can be found in the parameter <i>ErrorID</i>.
ErrorID	OUTPUT	WORD	<p>Additional error information</p> <p>Chap. 13.10 'ErrorID - Additional error information' page 637</p>

PLCopen-State

- Job start in each PLCopen-State possible.

Write axis parameter data

The writing of the axis parameter data is started with an edge 0-1 at *Execute*. *Busy* is TRUE as soon as writing of parameter data is running. After the parameter data was written, *Busy* with FALSE and *Done* with TRUE is returned.

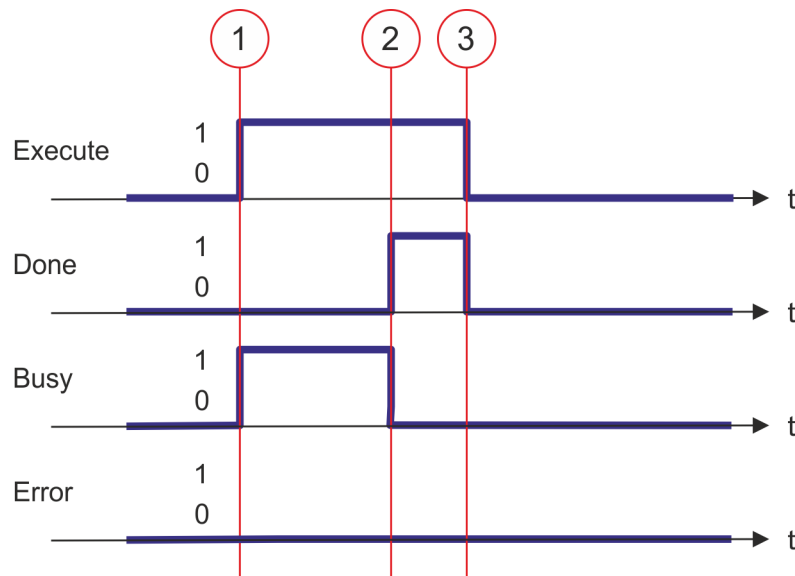

An active job continues to run even when *Execute* is set to FALSE.

Status diagram of the block parameters

- (1) At time (1) the writing of the parameter data is started with edge 0-1 at *Execute* and *Busy* becomes TRUE.
- (2) At the time (2) writing of the parameter data is successfully completed. *Busy* has the value FALSE and *Done* den value TRUE.
- (3) At the time (3) the job is completed and *Execute* becomes FALSE and thus each output parameter FALSE respectively 0.

13.7.3.23 FB 827 - VMC_ReadDWordParameter - read axis double word parameter data

Description



An overview of the drive systems, which can be controlled with this block can be found here: [↗ Chap. 13.7.1 'Overview' page 542](#)

With MC_ReadDWordParameter the parameter of data type DWORD, that is defined by the parameter number, is read from the axis. [↗ Chap. 13.7.3.35 'PLCopen parameter' page 611](#)

Parameter

Parameter	Declaration	Data type	Description
Axis	IN_OUT	MC_AXIS_REF	Reference to the axis
Execute	INPUT	BOOL	<ul style="list-style-type: none"> Read axis parameter data <ul style="list-style-type: none"> Edge 0-1: The parameter data is read
Parameter-Number	INPUT	INT	Number of the parameter to be read. ↗ Chap. 13.7.3.35 'PLCopen parameter' page 611
Done	OUTPUT	BOOL	<ul style="list-style-type: none"> Status <ul style="list-style-type: none"> TRUE: Job successfully done. Parameter data was read
Busy	OUTPUT	BOOL	<ul style="list-style-type: none"> Status <ul style="list-style-type: none"> TRUE: Job is running
Error	OUTPUT	BOOL	<ul style="list-style-type: none"> Status <ul style="list-style-type: none"> TRUE: An error has occurred. Additional error information can be found in the parameter <i>ErrorID</i>.
ErrorID	OUTPUT	WORD	Additional error information ↗ Chap. 13.10 'ErrorID - Additional error information' page 637
Value	OUTPUT	DWORD	Value of the read parameter

PLCopen-State

- Job start in each PLCopen-State possible.

Read axis parameter data

The reading of the axis parameter data is started with an edge 0-1 at *Execute*. *Busy* is TRUE as soon as reading of parameter data is running. After the parameter data was read, *Busy* with FALSE and *Done* with TRUE is returned. The output *Value* shows the value of the parameter.

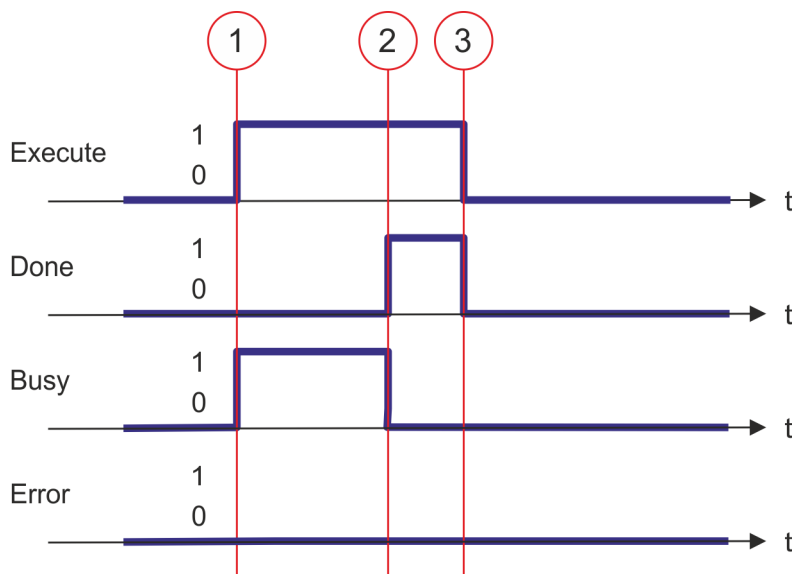

An active job continues to run even when *Execute* is set to FALSE.

Status diagram of the block parameters

- (1) At time (1) the reading of the parameter data is started with edge 0-1 at *Execute* and *Busy* becomes TRUE.
- (2) At the time (2) reading of the parameter data is successfully completed. *Busy* has the value FALSE and *Done* den value TRUE.
- (3) At the time (3) the job is completed and *Execute* becomes FALSE and thus each output parameter FALSE respectively 0.

13.7.3.24 FB 828 - VMC_WriteDWordParameter - write axis double word parameter data

Description



An overview of the drive systems, which can be controlled with this block can be found here: [↗ Chap. 13.7.1 'Overview' page 542](#)

With VMC_WriteDWordParameter the value of the parameter of data type DWORD, that is defined by the parameter number, is written to the axis. [↗ Chap. 13.7.3.35 'PLCopen parameter' page 611](#)

Parameter

Parameter	Declaration	Data type	Description
Axis	IN_OUT	MC_AXIS_REF	Reference to the axis
Execute	INPUT	BOOL	<ul style="list-style-type: none"> ■ Write axis parameter data <ul style="list-style-type: none"> – Edge 0-1: The parameter data is written
Parameter Number	INPUT	INT	Number of the parameter to be written. ↗ Chap. 13.7.3.35 'PLCopen parameter' page 611
Value	INPUT	DWORD	Value of the written parameter
Done	OUTPUT	BOOL	<ul style="list-style-type: none"> ■ Status <ul style="list-style-type: none"> – TRUE: Job successfully done. Parameter data was written
Busy	OUTPUT	BOOL	<ul style="list-style-type: none"> ■ Status <ul style="list-style-type: none"> – TRUE: Job is running
Error	OUTPUT	BOOL	<ul style="list-style-type: none"> ■ Status <ul style="list-style-type: none"> – TRUE: An error has occurred. Additional error information can be found in the parameter <i>ErrorID</i>.
ErrorID	OUTPUT	WORD	Additional error information ↗ Chap. 13.10 'ErrorID - Additional error information' page 637

PLCopen-State

- Job start in each PLCopen-State possible.

Write axis parameter data

The writing of the axis parameter data is started with an edge 0-1 at *Execute*. *Busy* is TRUE as soon as writing of parameter data is running. After the parameter data was written, *Busy* with FALSE and *Done* with TRUE is returned.

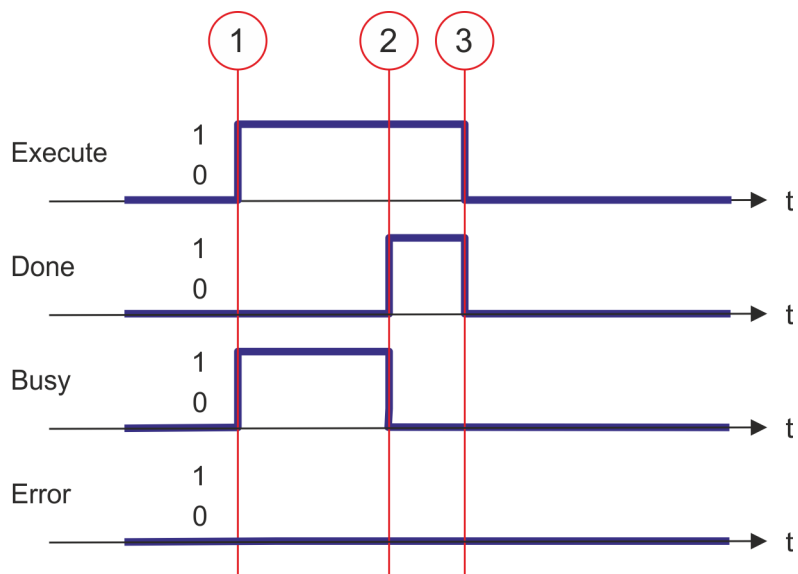

An active job continues to run even when *Execute* is set to FALSE.

Status diagram of the block parameters

- (1) At time (1) the writing of the parameter data is started with edge 0-1 at *Execute* and *Busy* becomes TRUE.
- (2) At the time (2) writing of the parameter data is successfully completed. *Busy* has the value FALSE and *Done* den value TRUE.
- (3) At the time (3) the job is completed and *Execute* becomes FALSE and thus each output parameter FALSE respectively 0.

13.7.3.25 FB 829 - VMC_ReadWordParameter - read axis word parameter data

Description



An overview of the drive systems, which can be controlled with this block can be found here: [↪ Chap. 13.7.1 'Overview' page 542](#)

With VMC_ReadWordParameter the parameter of data type WORD, that is defined by the parameter number, is read from the axis. [↪ Chap. 13.7.3.35 'PLCopen parameter' page 611](#)

Parameter

Parameter	Declaration	Data type	Description
Axis	IN_OUT	MC_AXIS_REF	Reference to the axis
Execute	INPUT	BOOL	<ul style="list-style-type: none"> Read axis parameter data <ul style="list-style-type: none"> Edge 0-1: The parameter data is read
Parameter Number	INPUT	INT	Number of the parameter to be read. ↪ Chap. 13.7.3.35 'PLCopen parameter' page 611
Done	OUTPUT	BOOL	<ul style="list-style-type: none"> Status <ul style="list-style-type: none"> TRUE: Job successfully done. Parameter data was read
Busy	OUTPUT	BOOL	<ul style="list-style-type: none"> Status <ul style="list-style-type: none"> TRUE: Job is running
Error	OUTPUT	BOOL	<ul style="list-style-type: none"> Status <ul style="list-style-type: none"> TRUE: An error has occurred. Additional error information can be found in the parameter <i>ErrorID</i>.
ErrorID	OUTPUT	WORD	Additional error information ↪ Chap. 13.10 'ErrorID - Additional error information' page 637
Value	OUTPUT	WORD	Value of the read parameter

PLCopen-State

- Job start in each PLCopen-State possible.

Read axis parameter data

The reading of the axis parameter data is started with an edge 0-1 at *Execute*. *Busy* is TRUE as soon as reading of parameter data is running. After the parameter data was read, *Busy* with FALSE and *Done* with TRUE is returned. The output *Value* shows the value of the parameter.

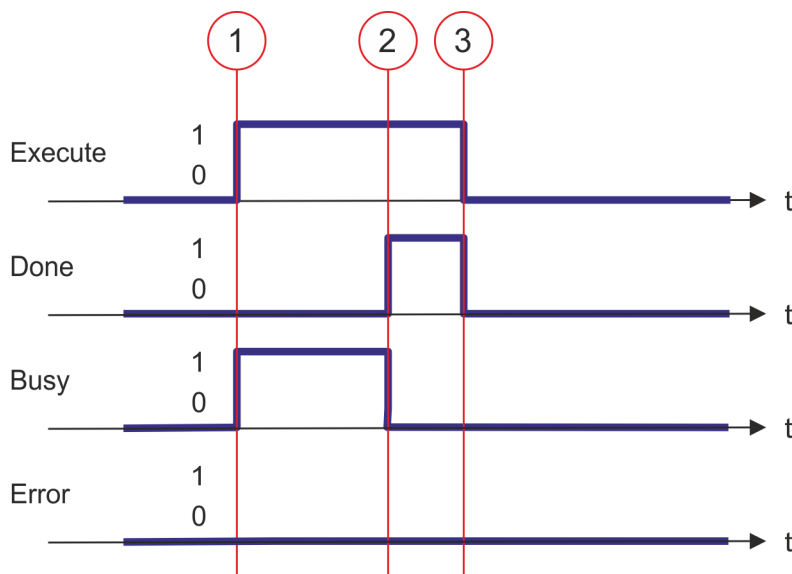

An active job continues to run even when *Execute* is set to FALSE.

Status diagram of the block parameters

- (1) At time (1) the reading of the parameter data is started with edge 0-1 at *Execute* and *Busy* becomes TRUE.
- (2) At the time (2) reading of the parameter data is successfully completed. *Busy* has the value FALSE and *Done* den value TRUE.
- (3) At the time (3) the job is completed and *Execute* becomes FALSE and thus each output parameter FALSE respectively 0.

13.7.3.26 FB 830 - VMC_WriteWordParameter - write axis word parameter data

Description



An overview of the drive systems, which can be controlled with this block can be found here: [Chap. 13.7.1 'Overview' page 542](#)

With VMC_WriteWordParameter the value of the parameter of data type WORD, that is defined by the parameter number, is written to the axis. [Chap. 13.7.3.35 'PLCopen parameter' page 611](#)

Parameter

Parameter	Declaration	Data type	Description
Axis	IN_OUT	MC_AXIS_REF	Reference to the axis
Execute	INPUT	BOOL	<ul style="list-style-type: none"> ■ Write axis parameter data <ul style="list-style-type: none"> – Edge 0-1: The parameter data is written
Parameter Number	INPUT	INT	Number of the parameter to be written. Chap. 13.7.3.35 'PLCopen parameter' page 611
Value	INPUT	WORD	Value of the written parameter
Done	OUTPUT	BOOL	<ul style="list-style-type: none"> ■ Status <ul style="list-style-type: none"> – TRUE: Job successfully done. Parameter data was written
Busy	OUTPUT	BOOL	<ul style="list-style-type: none"> ■ Status <ul style="list-style-type: none"> – TRUE: Job is running
Error	OUTPUT	BOOL	<ul style="list-style-type: none"> ■ Status <ul style="list-style-type: none"> – TRUE: An error has occurred. Additional error information can be found in the parameter <i>ErrorID</i>.
ErrorID	OUTPUT	WORD	<p>Additional error information</p> <p>Chap. 13.10 'ErrorID - Additional error information' page 637</p>

PLCopen-State

- Job start in each PLCopen-State possible.

Write axis parameter data

The writing of the axis parameter data is started with an edge 0-1 at *Execute*. *Busy* is TRUE as soon as writing of parameter data is running. After the parameter data was written, *Busy* with FALSE and *Done* with TRUE is returned.

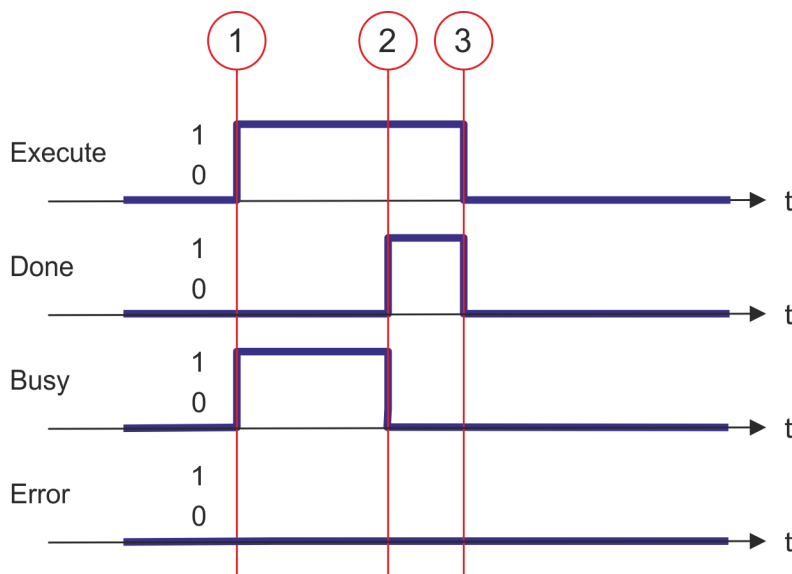

An active job continues to run even when *Execute* is set to FALSE.

Status diagram of the block parameters

- (1) At time (1) the writing of the parameter data is started with edge 0-1 at *Execute* and *Busy* becomes TRUE.
- (2) At the time (2) writing of the parameter data is successfully completed. *Busy* has the value FALSE and *Done* den value TRUE.
- (3) At the time (3) the job is completed and *Execute* becomes FALSE and thus each output parameter FALSE respectively 0.

13.7.3.27 FB 831 - VMC_ReadByteParameter - read axis byte parameter data

Description



An overview of the drive systems, which can be controlled with this block can be found here: [↪ Chap. 13.7.1 'Overview' page 542](#)

With VMC_ReadByteParameter the parameter of data type BYTE, that is defined by the parameter number, is read from the axis. [↪ Chap. 13.7.3.35 'PLCopen parameter' page 611](#)

Parameter

Parameter	Declaration	Data type	Description
Axis	IN_OUT	MC_AXIS_REF	Reference to the axis
Execute	INPUT	BOOL	<ul style="list-style-type: none"> Read axis parameter data <ul style="list-style-type: none"> Edge 0-1: The parameter data is read
Parameter Number	INPUT	INT	Number of the parameter to be read. ↪ Chap. 13.7.3.35 'PLCopen parameter' page 611
Done	OUTPUT	BOOL	<ul style="list-style-type: none"> Status <ul style="list-style-type: none"> TRUE: Job successfully done. Parameter data was read
Busy	OUTPUT	BOOL	<ul style="list-style-type: none"> Status <ul style="list-style-type: none"> TRUE: Job is running
Error	OUTPUT	BOOL	<ul style="list-style-type: none"> Status <ul style="list-style-type: none"> TRUE: An error has occurred. Additional error information can be found in the parameter <i>ErrorID</i>.
ErrorID	OUTPUT	WORD	Additional error information ↪ Chap. 13.10 'ErrorID - Additional error information' page 637
Value	OUTPUT	BYTE	Value of the read parameter

PLCopen-State

- Job start in each PLCopen-State possible.

Read axis parameter data

The reading of the axis parameter data is started with an edge 0-1 at *Execute*. *Busy* is TRUE as soon as reading of parameter data is running. After the parameter data was read, *Busy* with FALSE and *Done* with TRUE is returned. The output *Value* shows the value of the parameter.

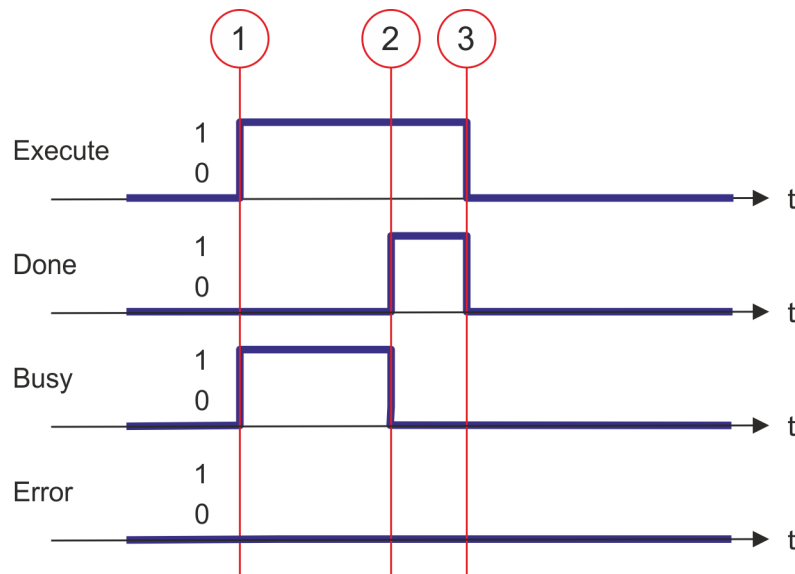

An active job continues to run even when *Execute* is set to FALSE.

Status diagram of the block parameters

- (1) At time (1) the reading of the parameter data is started with edge 0-1 at *Execute* and *Busy* becomes TRUE.
- (2) At the time (2) reading of the parameter data is successfully completed. *Busy* has the value FALSE and *Done* den value TRUE.
- (3) At the time (3) the job is completed and *Execute* becomes FALSE and thus each output parameter FALSE respectively 0.

13.7.3.28 FB 832 - VMC_WriteByteParameter - write axis byte parameter data

Description



An overview of the drive systems, which can be controlled with this block can be found here: [Chap. 13.7.1 'Overview' page 542](#)

With VMC_WriteByteParameter the value of the parameter of data type BYTE, that is defined by the parameter number, is written to the axis. [Chap. 13.7.3.35 'PLCopen parameter' page 611](#)

Parameter

Parameter	Declaration	Data type	Description
Axis	IN_OUT	MC_AXIS_REF	Reference to the axis
Execute	INPUT	BOOL	<ul style="list-style-type: none"> ■ Write axis parameter data <ul style="list-style-type: none"> – Edge 0-1: The parameter data is written
Parameter Number	INPUT	INT	Number of the parameter to be written. Chap. 13.7.3.35 'PLCopen parameter' page 611
Value	INPUT	BYTE	Value of the written parameter
Done	OUTPUT	BOOL	<ul style="list-style-type: none"> ■ Status <ul style="list-style-type: none"> – TRUE: Job successfully done. Parameter data was written
Busy	OUTPUT	BOOL	<ul style="list-style-type: none"> ■ Status <ul style="list-style-type: none"> – TRUE: Job is running
Error	OUTPUT	BOOL	<ul style="list-style-type: none"> ■ Status <ul style="list-style-type: none"> – TRUE: An error has occurred. Additional error information can be found in the parameter <i>ErrorID</i>.
ErrorID	OUTPUT	WORD	Additional error information Chap. 13.10 'ErrorID - Additional error information' page 637

PLCopen-State

- Job start in each PLCopen-State possible.

Write axis parameter data

The writing of the axis parameter data is started with an edge 0-1 at *Execute*. *Busy* is TRUE as soon as writing of parameter data is running. After the parameter data was written, *Busy* with FALSE and *Done* with TRUE is returned.

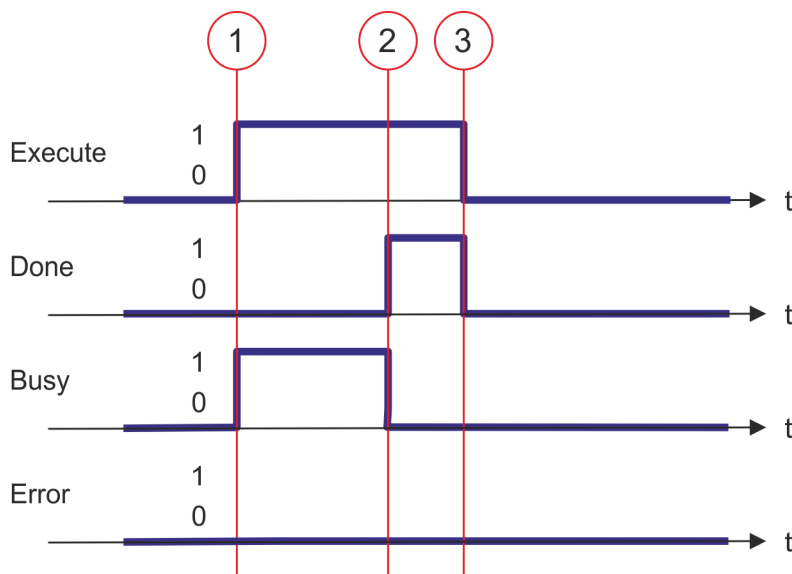

An active job continues to run even when *Execute* is set to FALSE.

Status diagram of the block parameters

- (1) At time (1) the writing of the parameter data is started with edge 0-1 at *Execute* and *Busy* becomes TRUE.
- (2) At the time (2) writing of the parameter data is successfully completed. *Busy* has the value FALSE and *Done* den value TRUE.
- (3) At the time (3) the job is completed and *Execute* becomes FALSE and thus each output parameter FALSE respectively 0.

13.7.3.29 FB 833 - VMC_ReadDriveParameter - read drive parameter

Description



An overview of the drive systems, which can be controlled with this block can be found here: [Chap. 13.7.1 'Overview' page 542](#)

With VMC_ReadDriveParameter the value of a parameter from the connected drive is read.

Parameter

Parameter	Declaration	Data type	Description
Axis	IN_OUT	MC_AXIS_REF	Reference to the axis
Execute	INPUT	BOOL	<ul style="list-style-type: none"> ■ Read drive parameter data <ul style="list-style-type: none"> – Edge 0-1: The drive parameter data is reading.
Index	INPUT	WORD	Index of the drive parameter
Subindex	INPUT	BYTE	Subindex of the drive parameter
Length	INPUT	BYTE	Length of data <ul style="list-style-type: none"> ■ 1: BYTE ■ 2: WORD ■ 4: DWORD
Done	OUTPUT	BOOL	<ul style="list-style-type: none"> ■ Status <ul style="list-style-type: none"> – TRUE: Job successfully done. Parameter data was read
Busy	OUTPUT	BOOL	<ul style="list-style-type: none"> ■ Status <ul style="list-style-type: none"> – TRUE: Job is running
Error	OUTPUT	BOOL	<ul style="list-style-type: none"> ■ Status <ul style="list-style-type: none"> – TRUE: An error has occurred. Additional error information can be found in the parameter <i>ErrorID</i>.
ErrorID	OUTPUT	WORD	Additional error information Chap. 13.10 'ErrorID - Additional error information' page 637
Value	OUTPUT	DWORD	Value of the read parameter

PLCopen-State

- Job start in each PLCopen-State possible.

Read drive parameter data

The reading of the parameter data is started with an edge 0-1 at *Execute*. *Busy* is TRUE as soon as reading of parameter data is running. After the parameter data was read, *Busy* with FALSE and *Done* with TRUE is returned. The output *Value* shows the value of the parameter.

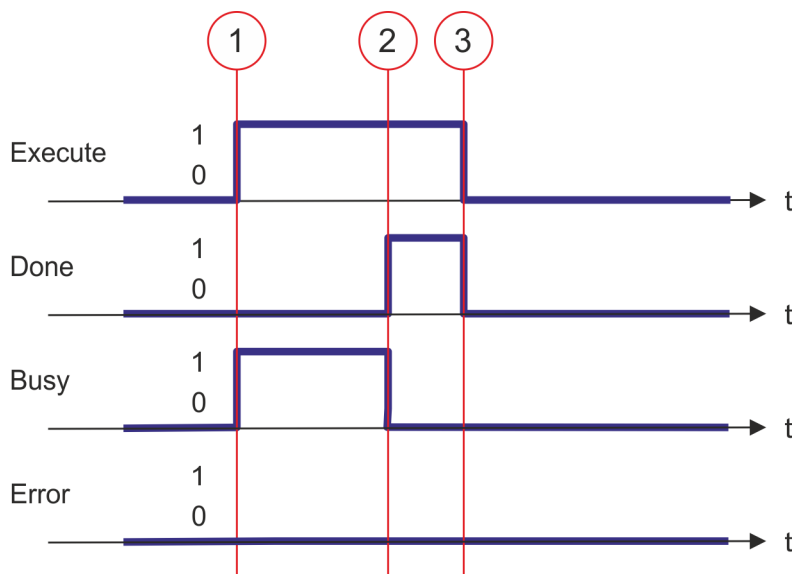

An active job continues to run even when *Execute* is set to FALSE.

**Status diagram of the
block parameters**

- (1) At time (1) the reading of the parameter data is started with edge 0-1 at *Execute* and *Busy* becomes TRUE.
- (2) At the time (2) reading of the parameter data is successfully completed. *Busy* has the value FALSE and *Done* den value TRUE.
- (3) At the time (3) the job is completed and *Execute* becomes FALSE and thus each output parameter FALSE respectively 0.

13.7.3.30 FB 834 - VMC_WriteDriveParameter - write drive parameter

Description



An overview of the drive systems, which can be controlled with this block can be found here: [Chap. 13.7.1 'Overview' page 542](#)

With VMC_WriteDriveParameter the value of the parameter is written to the connected drive.

Parameter

Parameter	Declaration	Data type	Description
Axis	IN_OUT	MC_AXIS_REF	Reference to the axis
Execute	INPUT	BOOL	<ul style="list-style-type: none"> ■ Write drive parameter data <ul style="list-style-type: none"> – Edge 0-1: The drive parameter data is written.
Index	INPUT	WORD	Index of the drive parameter
Subindex	INPUT	BYTE	Subindex of the drive parameter
Length	INPUT	BYTE	Length of data <ul style="list-style-type: none"> ■ 1: BYTE ■ 2: WORD ■ 4: DWORD
Value	INPUT	DWORD	Value of the written parameter
Done	OUTPUT	BOOL	<ul style="list-style-type: none"> ■ Status <ul style="list-style-type: none"> – TRUE: Job successfully done. Parameter data was read
Busy	OUTPUT	BOOL	<ul style="list-style-type: none"> ■ Status <ul style="list-style-type: none"> – TRUE: Job is running
Error	OUTPUT	BOOL	<ul style="list-style-type: none"> ■ Status <ul style="list-style-type: none"> – TRUE: An error has occurred. Additional error information can be found in the parameter <i>ErrorID</i>.
ErrorID	OUTPUT	WORD	Additional error information Chap. 13.10 'ErrorID - Additional error information' page 637

PLCopen-State

- Job start in each PLCopen-State possible.

Write drive parameter data

The writing of the parameter data is started with an edge 0-1 at *Execute*. *Busy* is TRUE as soon as writing of parameter data is running. After the parameter data was written, *Busy* with FALSE and *Done* with TRUE is returned.

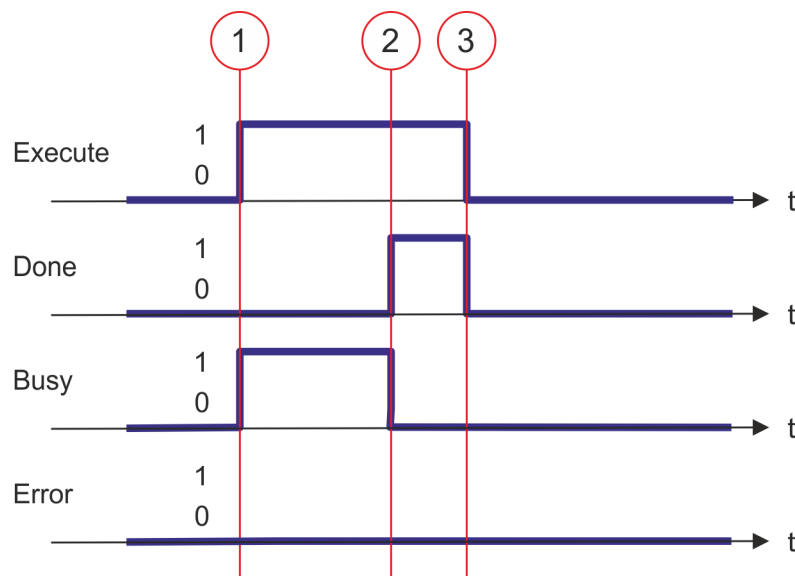

An active job continues to run even when *Execute* is set to FALSE.

Status diagram of the block parameters

- (1) At time (1) the writing of the parameter data is started with edge 0-1 at *Execute* and *Busy* becomes TRUE.
- (2) At the time (2) writing of the parameter data is successfully completed. *Busy* has the value FALSE and *Done* den value TRUE.
- (3) At the time (3) the job is completed and *Execute* becomes FALSE and thus each output parameter FALSE respectively 0.

13.7.3.31 FB 835 - VMC_HomeInit_LimitSwitch - Initialisation of homing on limit switch

Description



An overview of the drive systems, which can be controlled with this block can be found here: [↗ Chap. 13.7.1 'Overview' page 542](#)

This block initialises homing on limit switch.

Parameters

Parameter	Declaration	Data type	Description
Execute	IN	BOOL	<ul style="list-style-type: none"> ■ Initialisation of the homing method <ul style="list-style-type: none"> – Edge 0-1: Values of the input parameter are accepted and the initialisation of the homing method is started.
Direction	IN	BOOL	<ul style="list-style-type: none"> ■ Direction of homing <ul style="list-style-type: none"> – TRUE: on positive limit switch – FALSE: on negative limit switch
Velocity-SearchSwitch	IN	REAL	Velocity for search for the switch in [user units/s]
VelocitySearch-Zero	IN	REAL	Velocity for search for zero in [user units/s]
Acceleration	IN	REAL	Acceleration in [user units/s ²]
Done	OUT	BOOL	<ul style="list-style-type: none"> ■ Status <ul style="list-style-type: none"> – TRUE: Initialisation successfully done.
Busy	OUT	BOOL	<ul style="list-style-type: none"> ■ Status <ul style="list-style-type: none"> – TRUE: Initialisation is active.
Error	OUT	BOOL	<ul style="list-style-type: none"> ■ Status <ul style="list-style-type: none"> – TRUE: An error has occurred. Additional error information can be found in the parameter <i>ErrorID</i>.
ErrorID	OUT	WORD	Additional error information ↗ Chap. 13.10 'ErrorID - Additional error information' page 637
AXIS	IN_OUT	MC_AXIS_REF	Reference to the axis

Initialisation homing on limit switch

The values of the input parameters are accepted with an edge 0-1 at *Execute* and the initialisation of the homing method is started. As long as the initialisation is active, the output *Busy* is set to TRUE. If the initialisation has been completed successfully, the output *Done* is set to TRUE. If an error occurs during initialisation, the output *Error* is set to TRUE and an error number is output at the output *ErrorID*.

Initialisation of the homing method

1. ➤ Verify communication to the axis.
2. ➤ Check for permitted PLCopen states.
3. ➤ Check the input values:
 - Input VelocitySearchSwitch [UserUnits] > 0.0
 - VelocitySearchSwitch [InternalUnits] > 0
 - VelocitySearchSwitch [InternalUnits] ≤ VelocityMax
 - Input VelocitySearchZero [UserUnits] > 0.0
 - VelocitySearchZero [InternalUnits] > 0
 - VelocitySearchZero [InternalUnits] ≤ VelocityMax
 - Input Acceleration [UserUnits] > 0.0
 - Acceleration [InternalUnits] > 0
 - Acceleration [InternalUnits] ≤ AccelerationMax
4. ➤ Transfer of the drive parameters:
 - "Homing Method" in dependence of input "Direction"
See table below!
 - "Homing Speed during search for switch" [Inc/s]
 - "Homing Speed during search for zero" [Inc/s]
 - "Homing Acceleration" [Inc/s²]

Homing Method	Direction
1	false
2	true

13.7.3.32 FB 836 - VMC_HomeInit_HomeSwitch - Initialisation of homing on home switch

Description



An overview of the drive systems, which can be controlled with this block can be found here: [↪ Chap. 13.7.1 'Overview' page 542](#)

This block initialises homing on home switch.

Parameters

Parameter	Declaration	Data type	Description
Execute	IN	BOOL	<ul style="list-style-type: none"> ■ Initialisation of the homing method <ul style="list-style-type: none"> – Edge 0-1: Values of the input parameter are accepted and the initialisation of the homing method is started.
InitialDirection	IN	BOOL	<ul style="list-style-type: none"> ■ Initial direction of homing <ul style="list-style-type: none"> – TRUE: on positive limit switch – FALSE: on negative limit switch
WithIndexPulse	IN	BOOL	<ul style="list-style-type: none"> ■ Homing <ul style="list-style-type: none"> – TRUE: homing with index pulse – FALSE: homing without index pulse
OnRisingEdge	IN	BOOL	<ul style="list-style-type: none"> ■ Edge of home switch <ul style="list-style-type: none"> – TRUE: Edge 0-1 – FALSE: Edge 1-0
SameDirIndex-Pulse	IN	BOOL	<ul style="list-style-type: none"> ■ Search for index pulse <ul style="list-style-type: none"> – TRUE: After detecting the home, search for index pulse without change of direction – FALSE: After detecting the home, search for index pulse with change of direction
Velocity-SearchSwitch	IN	REAL	Velocity for search for the switch in [user units/s]
VelocitySearch-Zero	IN	REAL	Velocity for search for zero in [user units/s]
Acceleration	IN	REAL	Acceleration in [user units/s ²]
Done	OUT	BOOL	<ul style="list-style-type: none"> ■ Status <ul style="list-style-type: none"> – TRUE: Initialisation successfully done.
Busy	OUT	BOOL	<ul style="list-style-type: none"> ■ Status <ul style="list-style-type: none"> – TRUE: Initialisation is active.
Error	OUT	BOOL	<ul style="list-style-type: none"> ■ Status <ul style="list-style-type: none"> – TRUE: An error has occurred. Additional error information can be found in the parameter <i>ErrorID</i>.
ErrorID	OUT	WORD	Additional error information ↪ Chap. 13.10 'ErrorID - Additional error information' page 637
AXIS	IN_OUT	MC_AXIS_REF	Reference to the axis

Initialisation homing on home switch

The values of the input parameters are accepted with an edge 0-1 at *Execute* and the initialisation of the homing method is started. As long as the initialisation is active, the output *Busy* is set to TRUE. If the initialisation has been completed successfully, the output *Done* is set to TRUE. If an error occurs during initialisation, the output *Error* is set to TRUE and an error number is output at the output *ErrorID*.

Initialisation of the homing method

1. ➤ Verify communication to the axis.
2. ➤ Check for permitted PLCopen states.
3. ➤ Check the input values:
 - Input VelocitySearchSwitch [UserUnits] > 0.0
 - VelocitySearchSwitch [InternalUnits] > 0
 - VelocitySearchSwitch [InternalUnits] ≤ VelocityMax
 - Input VelocitySearchZero [UserUnits] > 0.0
 - VelocitySearchZero [InternalUnits] > 0
 - VelocitySearchZero [InternalUnits] ≤ VelocityMax
 - Input Acceleration [UserUnits] > 0.0
 - Acceleration [InternalUnits] > 0
 - Acceleration [InternalUnits] ≤ AccelerationMax
4. ➤ Transfer of the drive parameters:
 - "Homing Method" in dependence of input "Direction"
See Table below!
 - "Homing Speed during search for switch" [Inc/s]
 - "Homing Speed during search for zero" [Inc/s]
 - "Homing Acceleration" [Inc/s²]

Homing Method	InitialDirection	WithIndexPulse	OnRisingEdge	SameDirIndexPulse
7	positive	true	true	false
8	positive	true	true	true
9	positive	true	false	false
10	positive	true	false	true
11	negative	true	true	false
12	negative	true	true	true
13	negative	true	false	false
14	negative	true	false	true
24	positive	false	true	false
24	positive	false	true	true
24	positive	false	false	false
24	positive	false	false	true
28	negative	false	true	false
28	negative	false	true	true
28	negative	false	false	false
28	negative	false	false	true

13.7.3.33 FB 837 - VMC_HomeInit_ZeroPulse - Initialisation of homing on zero puls

Beschreibung



An overview of the drive systems, which can be controlled with this block can be found here: [↪ Chap. 13.7.1 'Overview' page 542](#)

This block initialises homing on zero pulse.

Parameters

Parameter	Declaration	Data type	Description
Execute	IN	BOOL	<ul style="list-style-type: none"> ■ Initialisation of the homing method <ul style="list-style-type: none"> – Edge 0-1: Values of the input parameter are accepted and the initialisation of the homing method is started.
Direction	IN	BOOL	<ul style="list-style-type: none"> ■ Direction of homing <ul style="list-style-type: none"> – TRUE: Positive direction – FALSE: Negative direction
VelocitySearchZero	IN	REAL	Velocity for search for zero in [user units/s]
Acceleration	IN	REAL	Acceleration in [user units/s ²]
Done	OUT	BOOL	<ul style="list-style-type: none"> ■ Status <ul style="list-style-type: none"> – TRUE: Initialisation successfully done.
Busy	OUT	BOOL	<ul style="list-style-type: none"> ■ Status <ul style="list-style-type: none"> – TRUE: Initialisation is active.
Error	OUT	BOOL	<ul style="list-style-type: none"> ■ Status <ul style="list-style-type: none"> – TRUE: An error has occurred. Additional error information can be found in the parameter <i>ErrorID</i>.
ErrorID	OUT	WORD	Additional error information ↪ Chap. 13.10 'ErrorID - Additional error information' page 637
AXIS	IN_OUT	MC_AXIS_REF	Reference to the axis

Initialisation homing on zero pulse

The values of the input parameters are accepted with an Edge 0-1 at *Execute* and the initialisation of the homing method is started. As long as the initialisation is active, the output *Busy* is set to TRUE. If the initialisation has been completed successfully, the output *Done* is set to TRUE. If an error occurs during initialisation, the output *Error* is set to TRUE and an error number is output at the output *ErrorID*.

Initialisation of the homing method

1. Verify communication to the axis.
2. Check for permitted PLCopen states.
3. Check the input values:
 - Input VelocitySearchZero [UserUnits] > 0.0
 - VelocitySearchZero [InternalUnits] > 0
 - VelocitySearchZero [InternalUnits] ≤ VelocityMax
 - Input Acceleration [UserUnits] > 0.0
 - Acceleration [InternalUnits] > 0
 - Acceleration [InternalUnits] ≤ AccelerationMax

4. → Transfer of the drive parameters:

- "Homing Method" in dependence of input "Direction" See table below!
- "Homing Speed during search for switch" [Inc/s]
- "Homing Speed during search for zero" [Inc/s]
- "Homing Acceleration" [Inc/s²]

Homing Method	Direction
33	false
34	true

13.7.3.34 FB 838 - VMC_HomeInit_SetPosition - Initialisation of homing mode set position

Description



An overview of the drive systems, which can be controlled with this block can be found here: [Chap. 13.7.1 'Overview' page 542](#)

This block initialises homing on current position.

Parameters

Parameter	Declaration	Data type	Description
Execute	IN	BOOL	<ul style="list-style-type: none"> ■ Initialisation of the homing method <ul style="list-style-type: none"> – Edge 0-1: Values of the input parameter are accepted and the initialisation of the homing method is started.
Done	OUT	BOOL	<ul style="list-style-type: none"> ■ Status <ul style="list-style-type: none"> – TRUE: Initialisation successfully done.
Busy	OUT	BOOL	<ul style="list-style-type: none"> ■ Status <ul style="list-style-type: none"> – TRUE: Initialisation is active.
Error	OUT	BOOL	<ul style="list-style-type: none"> ■ Status <ul style="list-style-type: none"> – TRUE: An error has occurred. Additional error information can be found in the parameter ErrorID.
ErrorID	OUT	WORD	Additional error information Chap. 13.10 'ErrorID - Additional error information' page 637
AXIS	IN_OUT	MC_AXIS_REF	Reference to the axis

Initialisation homing on home switch

The values of the input parameters are accepted with an edge 0-1 at *Execute* and the initialisation of the homing method is started. As long as the initialisation is active, the output *Busy* is set to TRUE. If the initialisation has been completed successfully, the output *Done* is set to TRUE. If an error occurs during initialisation, the output *Error* is set to TRUE and an error number is output at the output *ErrorID*.

Initialisation of the homing method

1. Verify communication to the axis.
2. Check for permitted PLCopen states.
3. Transfer of the drive parameters:
 - "Homing Method" = 35

13.7.3.35 PLCopen parameter

PN	Name	Data type	R/W	Comments
1	CommandedPosition	REAL	R	Commanded position Access on: <code>#Axis.Status.Positioning.SetValues.CommandedPosition</code>
2	SWLimitPos	REAL	R/W	Positive software limit switch position Access on: <code>"Axis".AxisConfiguration.PositionLimits.MaxPosition</code>
3	SWLimitNeg	REAL	R/W	Negative software limit switch position Access on: <code>"Axis".AxisConfiguration.PositionLimits.MinPosition</code>
4	EnableLimitPos	BOOL	R/W	Enable positive software limit switch Access on: <code>"Axis".AxisConfiguration.PositionLimits.EnableMaxPos</code>
5	EnableLimitNeg	BOOL	R/W	Enable negative software limit switch Access on: <code>"Axis".AxisConfiguration.PositionLimits.EnableMinPos</code>
6	EnablePosLagMonitoring	BOOL	R/W	Enable monitoring of position lag Function is not supported
7	MaxPositionLag	REAL	R/W	Maximal position lag Function is not supported
8	MaxVelocitySystem	REAL	R	Maximal allowed velocity of the axis in the motion system This parameter is currently not supported
9	MaxVelocityAppl	REAL	R/W	Maximal allowed velocity of the axis in the application Access on: <code>#Axis.AxisConfiguration.DynamicLimits.MaxVelocityApp</code>
10	ActualVelocity	REAL	R	Actual velocity Access on: <code>#Axis.Status.Positioning.ActValues.Velocity</code>
11	CommandedVelocity	REAL	R	Commanded velocity Access on: <code>#Axis.Status.Positioning.SetValues.Velocity</code>
12	MaxAccelerationSystem	REAL	R	Maximal allowed acceleration of the axis in the motion system This parameter is currently not supported

Blocks for axis control > Complex motion tasks - PLCopen blocks

PN	Name	Data type	R/W	Comments
13	MaxAccelerationAppl	REAL	R/W	Maximal allowed acceleration of the axis in the application Access on: <code>#Axis.AxisConfiguration.DynamicLimits.MaxAccelerationApp</code>
14	MaxDecelerationSystem	REAL	R	Maximal allowed deceleration of the axis in the motion system This parameter is currently not supported
15	MaxDecelerationAppl	REAL	R/W	Maximal allowed deceleration of the axis in the application Access on: <code>#Axis.AxisConfiguration.DynamicLimits.MaxDecelerationApp</code>
16	MaxJerkSystem	REAL	R	Maximum allowed jerk of the axis in the motion system This parameter is currently not supported
17	MaxJerkAppl	REAL	R/W	Maximum allowed jerk of the axis in the application This parameter is currently not supported.

13.7.3.36 VIPA-specific parameter

Positioning axis: Yaskawa *Sigma-5 / Sigma-7* via EtherCAT

No.	Name	Data type	Index	Subindex	Access
900	HomingDone	BOOL	-	-	R/W ^{1,2}
901	PositiveTorqueLimit	BOOL	-	-	R/W ^{1,2}
902	NegativeTorqueLimit	BOOL	-	-	R/W ^{1,2}
1000	ErrorCode	WORD	603F	0	R ³
1001	HomeOffset	DWORD	607C	0	R/W ^{5,6}
1002	HomingMethod	WORD	6098	0	R/W ^{3,4}
1003	SpeedSearchSwitch	DWORD	6099	1	R/W ^{5,6}
1004	SpeedSearchZero	DWORD	6099	2	R/W ^{5,6}
1005	HomingAcceleration	DWORD	609A	0	R/W ^{5,6}
1006	PositiveTorqueLimit	WORD	60E0	0	R/W ^{3,4}
1007	NegativeTorqueLimit	WORD	0x60E1	0	R/W ^{3,4}
1008	MotorRatedTorque	DWORD	0x6076	0	R/W ^{5,6}

1) Access via [Chap. 13.7.3.21 'FB 825 - MC_ReadBoolParameter - read axis boolean parameter data' page 584](#)

2) Access via [Chap. 13.7.3.22 'FB 826 - MC_WriteBoolParameter - write axis boolean parameter data' page 586](#)

3) Access via [Chap. 13.7.3.25 'FB 829 - VMC_ReadWordParameter - read axis word parameter data' page 592](#)

4) Access via [Chap. 13.7.3.26 'FB 830 - VMC_WriteWordParameter - write axis word parameter data' page 594](#)

5) Access via [Chap. 13.7.3.23 'FB 827 - VMC_ReadDWordParameter - read axis double word parameter data' page 588](#)

6) Access via [Chap. 13.7.3.24 'FB 828 - VMC_WriteDWordParameter - write axis double word parameter data' page 590](#)

No.	Name	Data type	Index	Subindex	Access
1009	FollowingErrorWindow	DWORD	0x6065	0	R/W ^{5, 6}
1010	FollowingErrorTimeOut	WORD	0x6066	0	R/W ^{3, 4}
1011	PositionWindow	DWORD	0x6067	0	R/W ^{5, 6}
1012	PositionTime	WORD	0x6068	0	R/W ^{3, 4}
1013	Min Position Limit	DWORD	0x607D	1	R/W ^{5, 6}
1014	Max Position Limit	DWORD	0x607D	2	R/W ^{5, 6}
1015	Digital outputs/ physical outputs	DWORD	0x60FE	1	R/W ^{5, 6}
1016	Digital outputs/ mask	DWORD	0x60FE	2	R/W ^{5, 6}
1017	Quick stop deceleration	DWORD	0x6085	0	R/W ^{5, 6}
1018	Forward external torque limit	WORD	0x2404	0	R/W ^{3, 4}
1019	Reverse external torque limit	WORD	0x2405	0	R/W ^{3, 4}

1) Access via [Chap. 13.7.3.21 'FB 825 - MC_ReadBoolParameter - read axis boolean parameter data' page 584](#)

2) Access via [Chap. 13.7.3.22 'FB 826 - MC_WriteBoolParameter - write axis boolean parameter data' page 586](#)

3) Access via [Chap. 13.7.3.25 'FB 829 - VMC_ReadWordParameter - read axis word parameter data' page 592](#)

4) Access via [Chap. 13.7.3.26 'FB 830 - VMC_WriteWordParameter - write axis word parameter data' page 594](#)

5) Access via [Chap. 13.7.3.23 'FB 827 - VMC_ReadDWordParameter - read axis double word parameter data' page 588](#)

6) Access via [Chap. 13.7.3.24 'FB 828 - VMC_WriteDWordParameter - write axis double word parameter data' page 590](#)

13.8 Controlling the drive via HMI

13.8.1 Overview

Drive control via an HMI is possible with the following library groups:

- *Sigma-5* EtherCAT [288](#)
- *Sigma-7S* EtherCAT [324](#)
- *Sigma-7W* EtherCAT [362](#)
- *Sigma-5/7* Pulse Train [405](#)

To control the corresponding drive via an HMI such as Touch Panel or Panel PC, there is a symbol library for Movicon. You can use the templates to control the corresponding VMC_AxisControl function block. The Symbol Library contains the following templates:

- Numeric Touchpad
 - This is an input field adapted to the VMC_AxisControl templates for different display resolutions.
 - You can use the touch pad instead of the default input field.
- VMC_AxisControl
 - Template for controlling the FB 860 - VMC_AxisControl function block in the CPU.
 - The template is available for different display resolutions.

Controlling the drive via HMI > Create a new project

- VMC_AxisControl ... Trend
 - Template for controlling the FB 860 - VMC_AxisControl function block in the CPU, which additionally shows the graphic trend of the drive.
 - The use of this template can affect the performance of the panel.
 - The template is available for different display resolutions.
- VMC_AxisControl_PT
 - Template for controlling the FB 875 - VMC_AxisControl_PT function block in the CPU, which drive is connected via Pulse Train.
 - The template is available for different display resolutions.



Please note that currently no ECO panels are supported!

Installation in Movicon

1. ➤ Go to the service area of www.vipa.com.
2. ➤ Download the 'Symbol library for Movicon' from the download area at 'VIPA Lib'.
3. ➤ Specify a target directory in which the blocks are to be stored and start the unzip process with [OK].
4. ➤ Open the library after unzipping and drag and drop the Symbol library 'vipa simple motion control VX.X.X.msxz' and the Language table 'vipa simple motion control VX.X.X.CSV' to the Movicon user directory ...\\Public\\Documents\\Progea\\Movicon\\Symbols.
 - ⇒ After restarting Movicon, the symbol library is available in Movicon via the 'Symbol libraries'.

In order for the texts of the templates to be displayed correctly, you must import the language table into your project. ↪ 'Import voice table' page 620

13.8.2 Create a new project

Create a project

1. ➤ Start Movicon and open the project wizard via 'File → New'.
2. ➤ Select 'Win32/64 platform' as target platform and click at [Open].

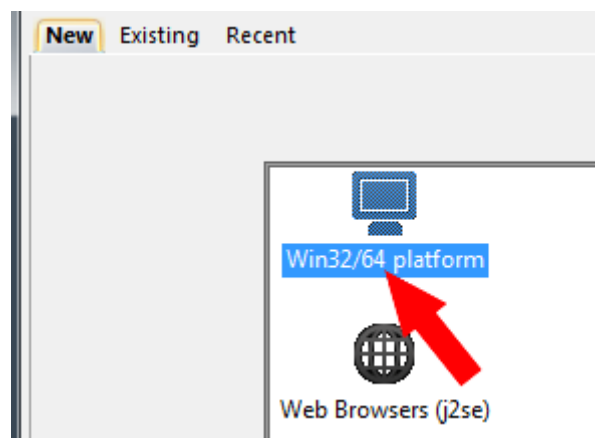

⇒ The dialog 'Device properties' opens.

3. Specify a project name at 'Name'.
Specify at 'Folder' a storage area.
Leave all settings disabled and click at [Next].

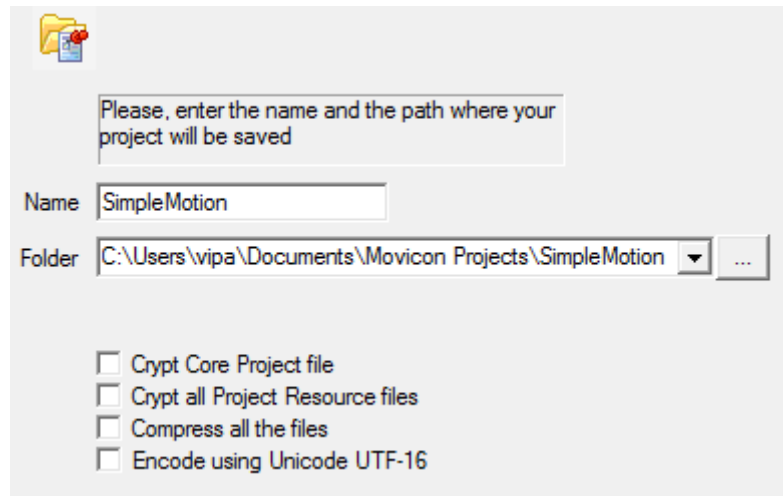

Please, enter the name and the path where your project will be saved

Name: SimpleMotion

Folder: C:\Users\vipa\Documents\Movicon Projects\SimpleMotion

Crypt Core Project file
 Crypt all Project Resource files
 Compress all the files
 Encode using Unicode UTF-16

⇒ The dialog 'Users' opens.

4. Make the appropriate user settings, if desired, or enable only 'CRF-21-Part...' and click at [Next].

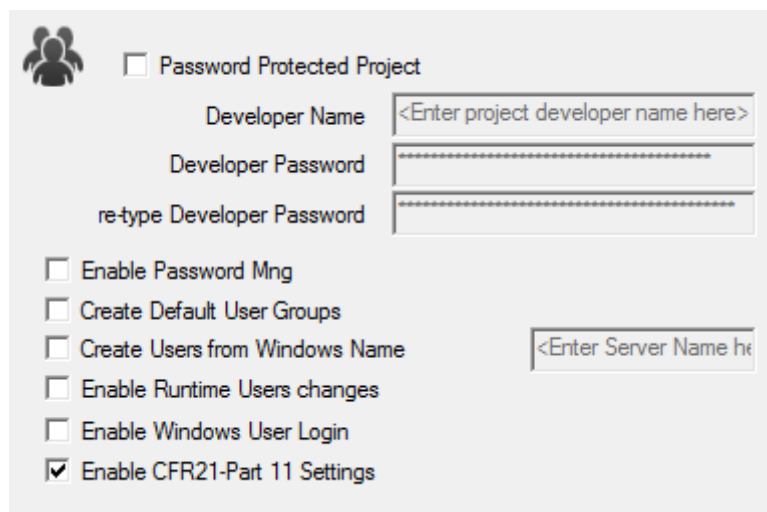

Password Protected Project

Developer Name: <Enter project developer name here>

Developer Password: [Empty]

re-type Developer Password: [Empty]

Enable Password Mng
 Create Default User Groups
 Create Users from Windows Name: <Enter Server Name here>
 Enable Runtime Users changes
 Enable Windows User Login
 Enable CFR21-Part 11 Settings

⇒ The dialog 'Add Comm. I/O Driver' opens.

Controlling the drive via HMI > Create a new project

5. Since the connection to the CPU is via TCP/IP, enable in the 'List Available Comm.Drivers' the driver 'VIPA' > 'Ethernet S7 TCP' and click at [Next].

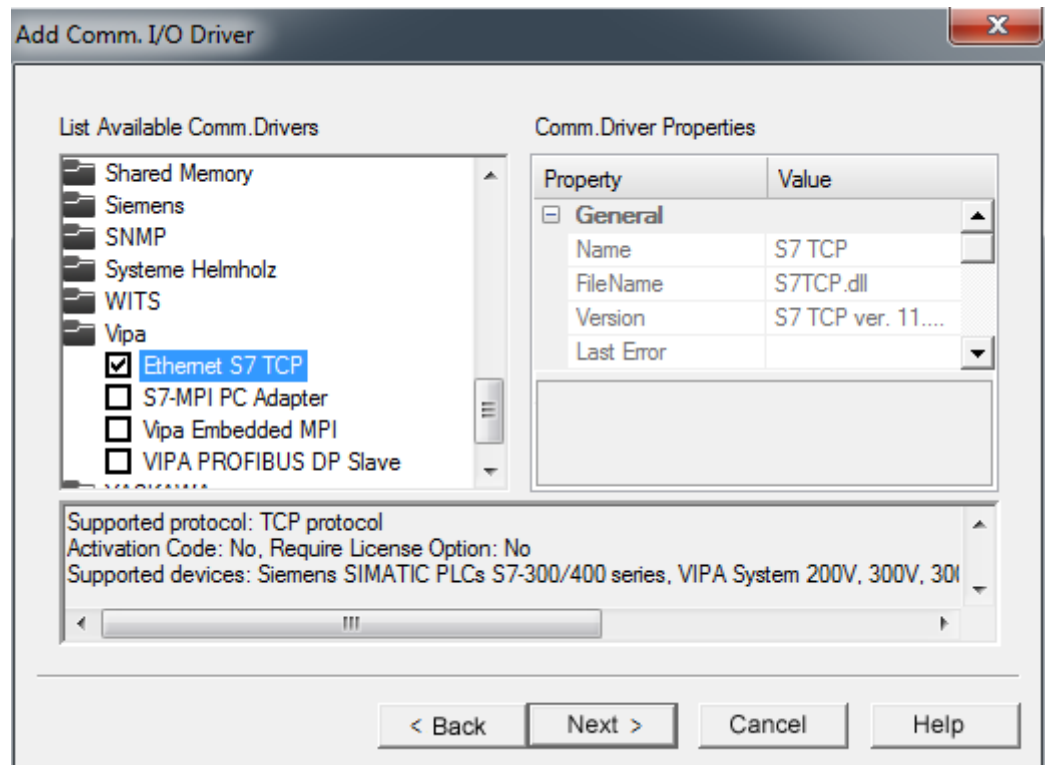

⇒ The dialog 'Screens' opens.

6. Enter 2 screens and their size, which matches your panel and click at [Next].

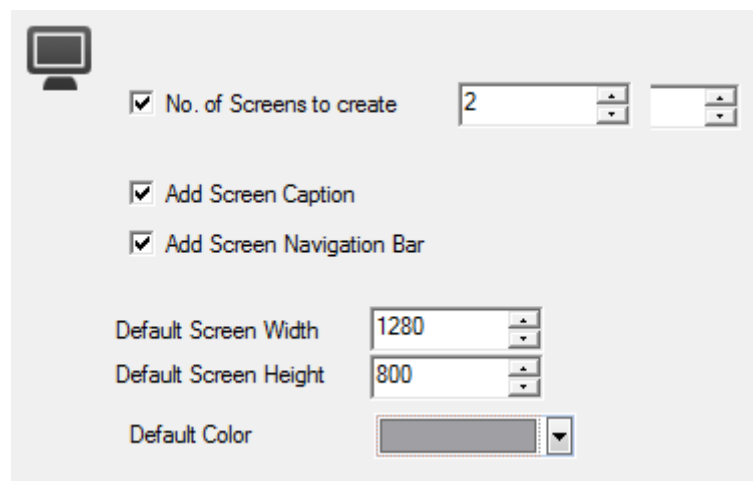

⇒ The dialog 'Data base settings (ODBC)' opens.

7. If you want a database connection, you can make the corresponding settings here. Otherwise, click at [Next].

⇒ The dialog 'Data logger and recipe settings (ODBC)' opens.

8. If templates are to be generated, you can make the corresponding settings here. Otherwise, click at [Next].

⇒ The dialog 'Alarm settings' opens.

9. ➤ If alarms are to be generated, you can make the corresponding settings here. Otherwise, click at [Finish].
 - ⇒ Your project is created with the settings you have made and the settings dialog for the 'S7TCP' communication driver opens automatically.
10. ➤ Select the register 'Stations'.
11. ➤ To add a new station, click [+ Add].

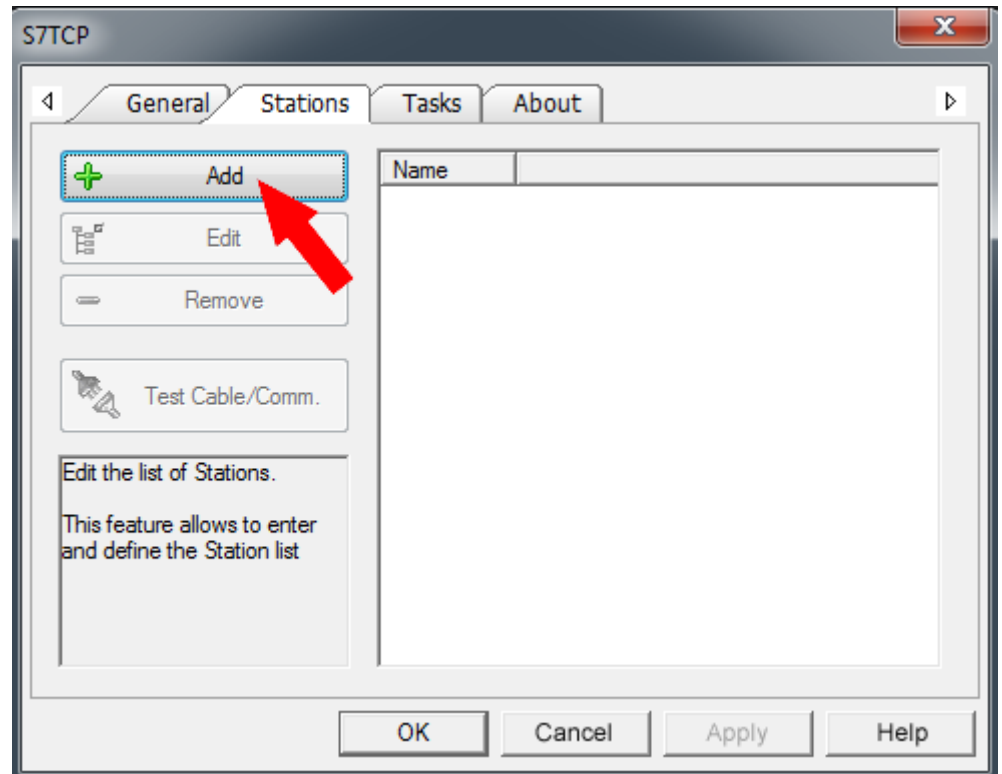

⇒ The dialog 'Station Properties' opens.

Controlling the drive via HMI > Create a new project

- 12.** Enter a station name at 'Station Name'. You have to use this name for the screen in the initialization dialog further below. Allowed characters: A-Z, a-z, 0-9 space and the separators "_" and "-"

Enter at 'Server Address' the IP address of your CPU and click at [OK].

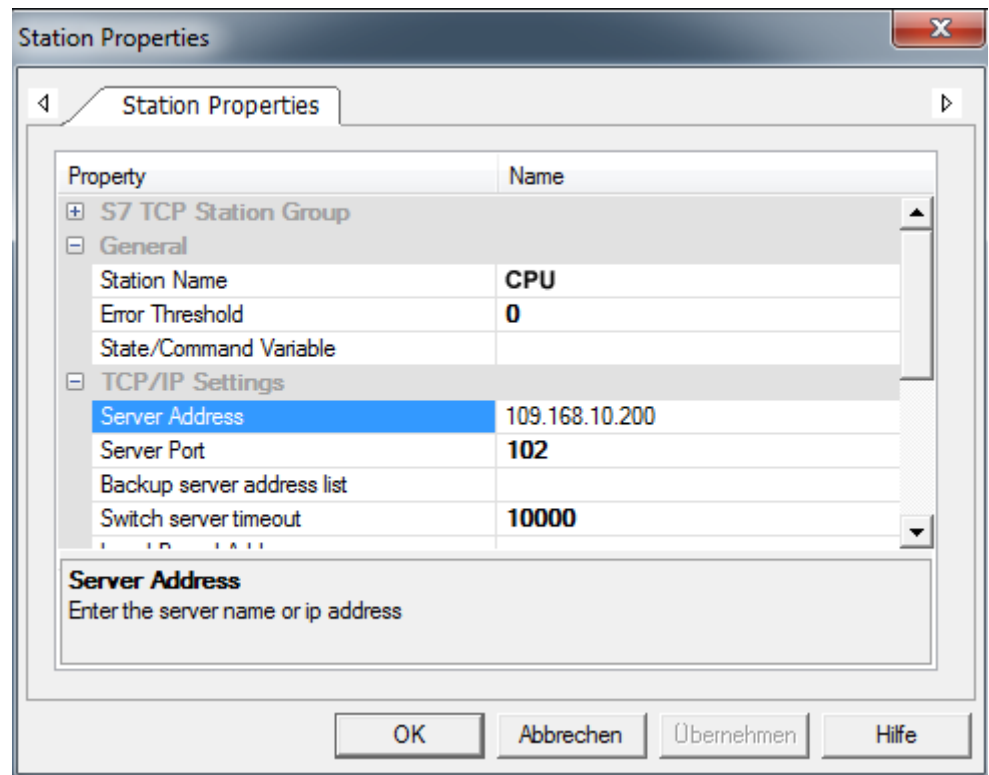

- 13.** Negate the query for importing variables from the PLC database and close the 'S7TCP' dialog with [OK].
- ⇒ The project and the workspace are now enabled for use. In the project at 'Ressourcen > SimpleMotion' the standard elements were added by the following elements:
 - Real Time DB
 - Comm.Drivers
 - S7 TCP
 - Screens
 - Screen1
 - Screen2
 - Footer Buttons

13.8.3 Modify the project in Movicon

Configuring the screen

1. Open via 'Resources > SimpleMotion > Screens' 'Screen1'.
2. Navigate in 'Browse Folders' at 'vipa simple motion control ...' and drag & drop from the 'Library view' the template to the 'Screen1', which matches the resolution of your panel.

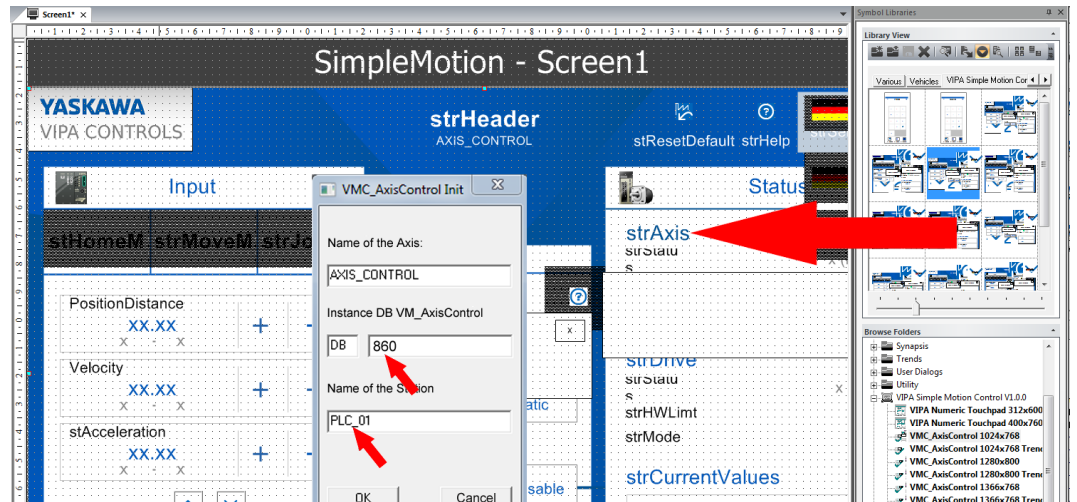

⇒ The initialization dialog opens

3. Specify a name for the axis. Allowed characters: A-Z, a-z, 0-9, space and the separators "_" and "-"

Specify the instance DB number that you use in your PLC program.

Specify the station name. This must match the 'Station Name' from 'Station Properties' of the 'S7 TCP' communication settings. Allowed characters: A-Z, a-z, 0-9, space and the separators "_" and "-"

⇒ With [OK] all variables as well as their structures are generated and the addresses are set to the specified destination address.

4. Place the template and adjust its size.

i Variables are created for each template under the corresponding name. When deleting the template, the corresponding variables must be deleted again. You can select these at 'Resources > SimpleMotion > Real Time DB > Variables'. Delete these together with the higher-level directory. If no further templates access the 'Structure Prototypes' for the Axis control, these must also be deleted.

Import voice table

The templates refer to the displayed texts from a language table, which is to be imported from the working directory into your project.

1. ➤ Select *Tools* ➔ *Csv String Importer-Exporter*.

⇒ The *'String Import/Export tool'* opens.

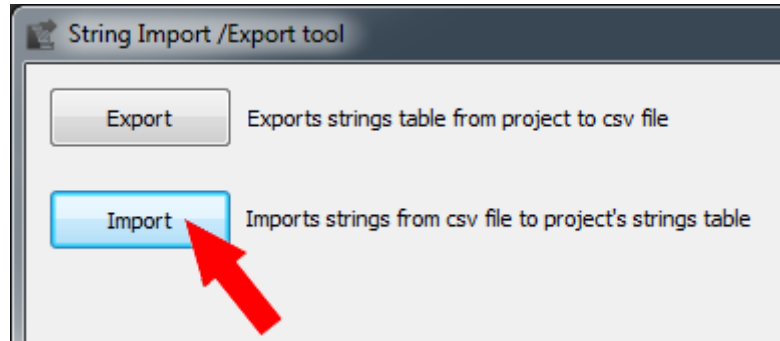

2. ➤ Click at [Import].

3. ➤ For the CSV file, use [...] to navigate to your Movicon user directory ...\Public\Documents\Progea\Movicon\Symbols and select the file *'vipa simple motion control VX.X.X.CSV'*.

4. ➤ As a project directory, you specify the project file *'simplemotion.movprj'* which is located in the user directory such as ...\vipa\Documents\Movicon Projects\Simple-Motion.

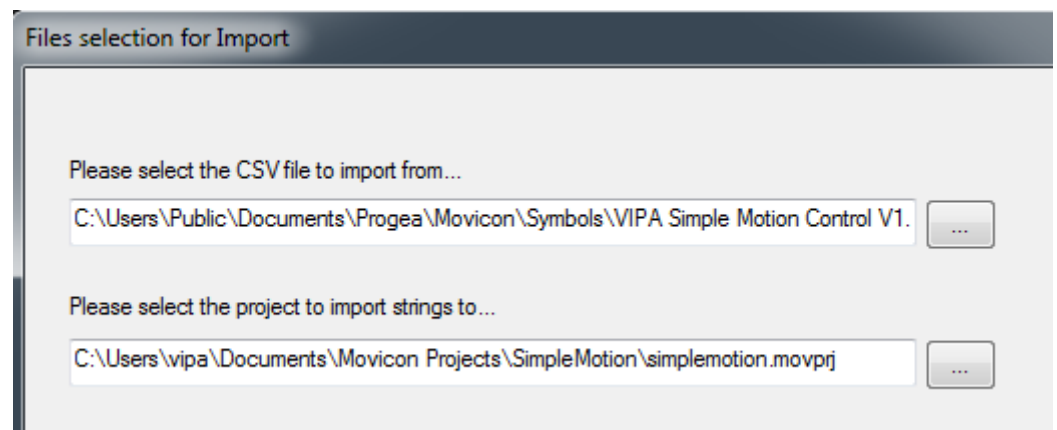

5. ➤ Click at [Continue].

⇒ *'Language selection'* opens.

6. ➤ Select [Select all languages] and click at [Finish].

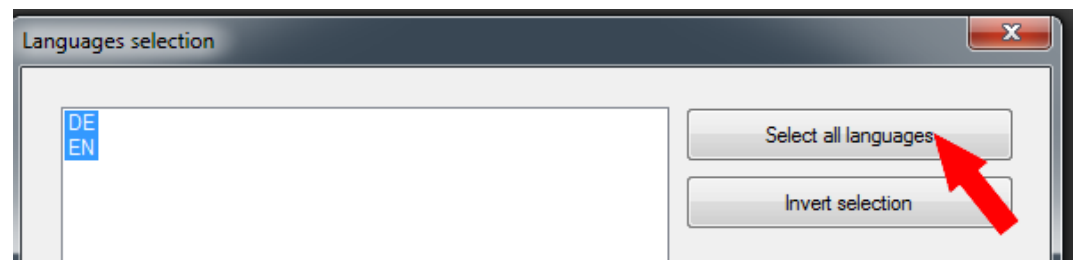

⇒ The language table is imported into your project.

7. ➤ After successful import, close the *'String Import/Export tool'*.

Adjust the numeric input field

At the templates, you will find a *'Numeric Touchpad'* in various resolutions. This is an input field adapted to the VMC_AxisControl templates for different display resolutions. You can use this touch pad instead of the default input field using the following procedure.

1. Click at *'Resources > SimpleMotion > Screens'* and select *'Context menu > Add a new screen'*.

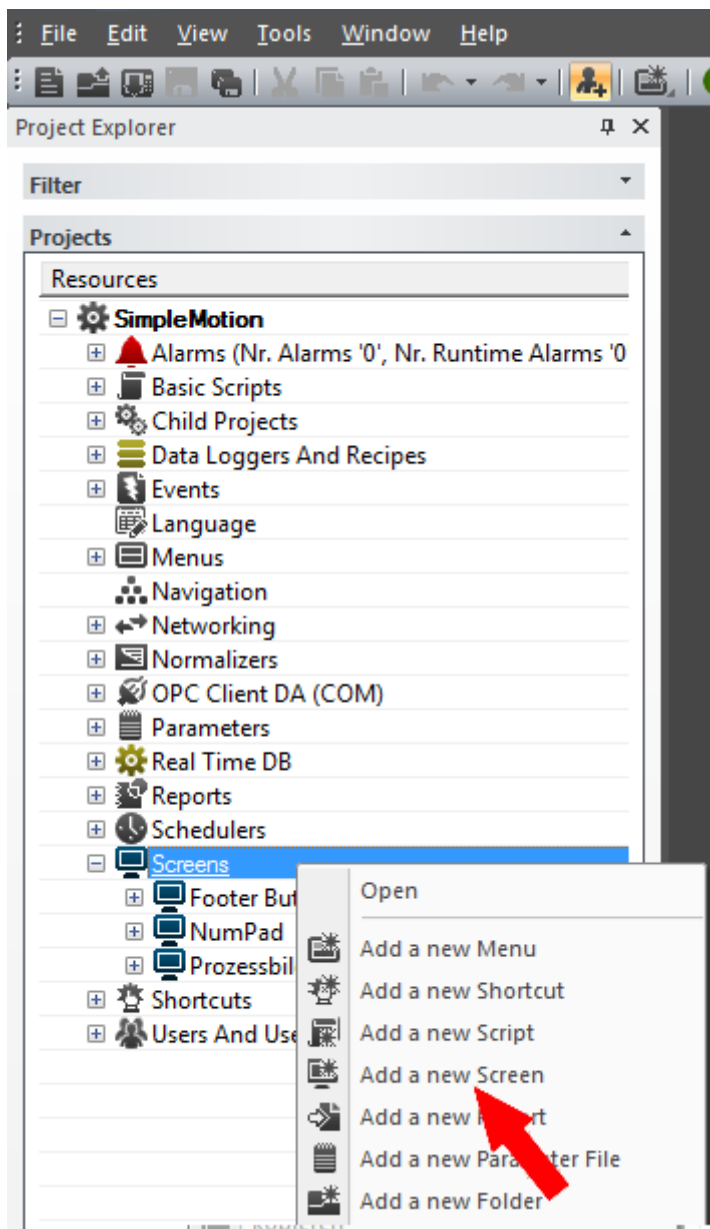

2. Assign a name such as *'NumPad'* and confirm with [OK].

Controlling the drive via HMI > Modify the project in Movicon

3. Click at the screen 'NumPad' and adjust via 'Context menu → Properties' width and height such as 'Width' = 400 and 'Height' = 700. Confirm with ✓ your settings.

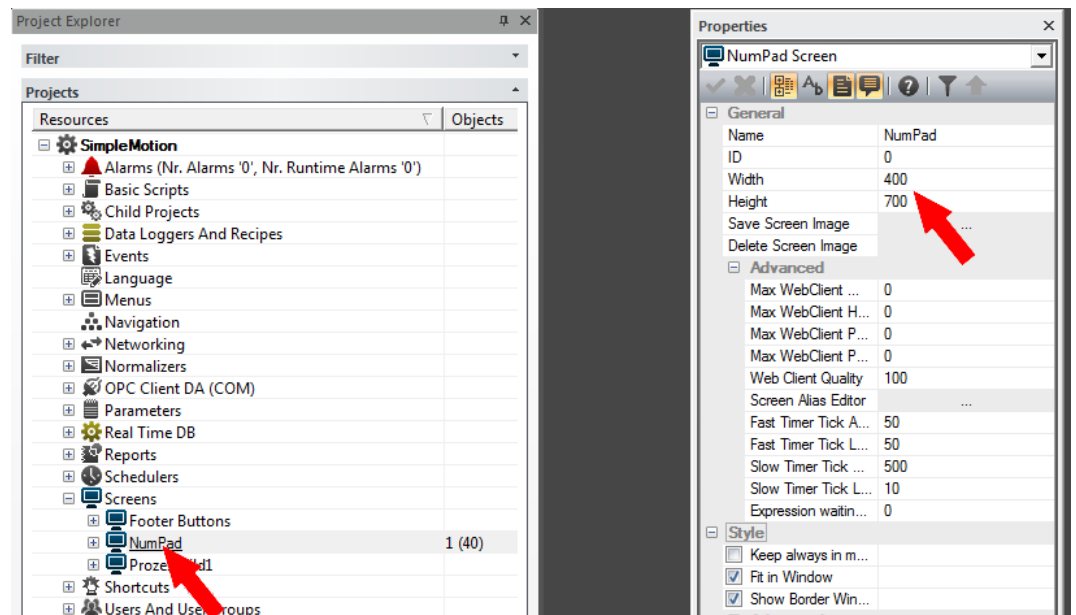

4. Select 'View → Symbol Libraries'. Navigate in 'Browse Folders' at 'vipa simple motion control ...' and drag & drop from the 'Library view' the 'Numeric Touchpad' template to the 'NumPad', which matches the resolution of your panel.

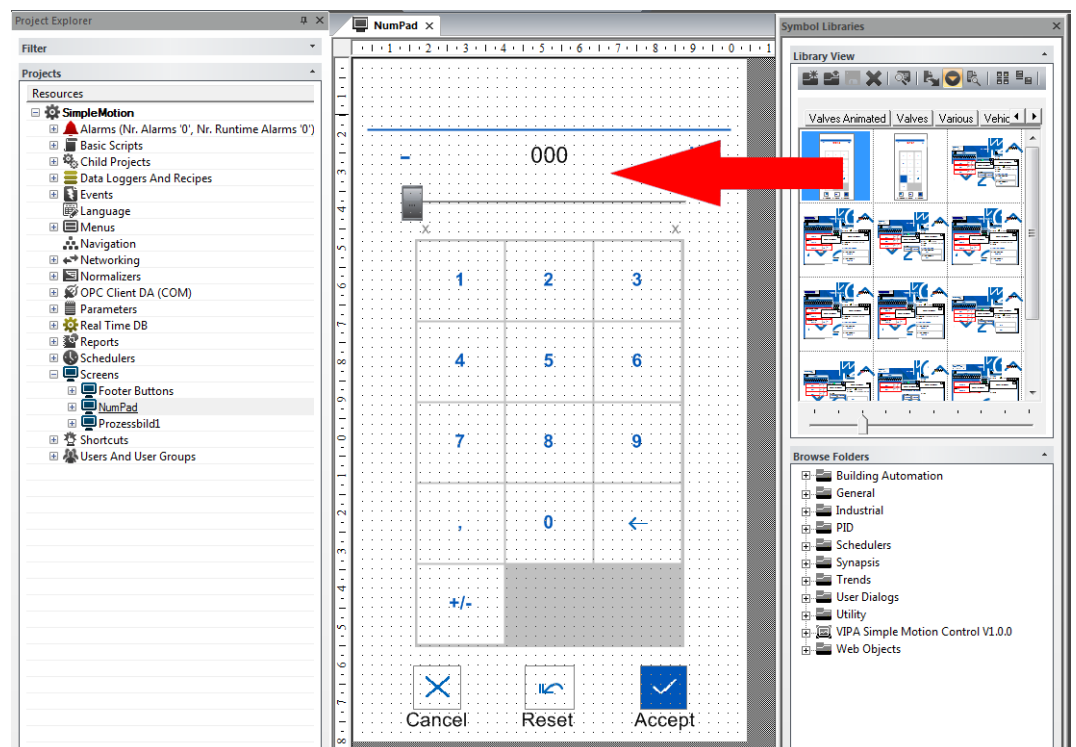

5. If necessary, adjust its size.
6. Click at 'Resources > SimpleMotion' and select 'Context menu → Properties'.

7. Select at 'General > Advanced' the numeric touch pad 'NumPad'. Confirm with your settings.

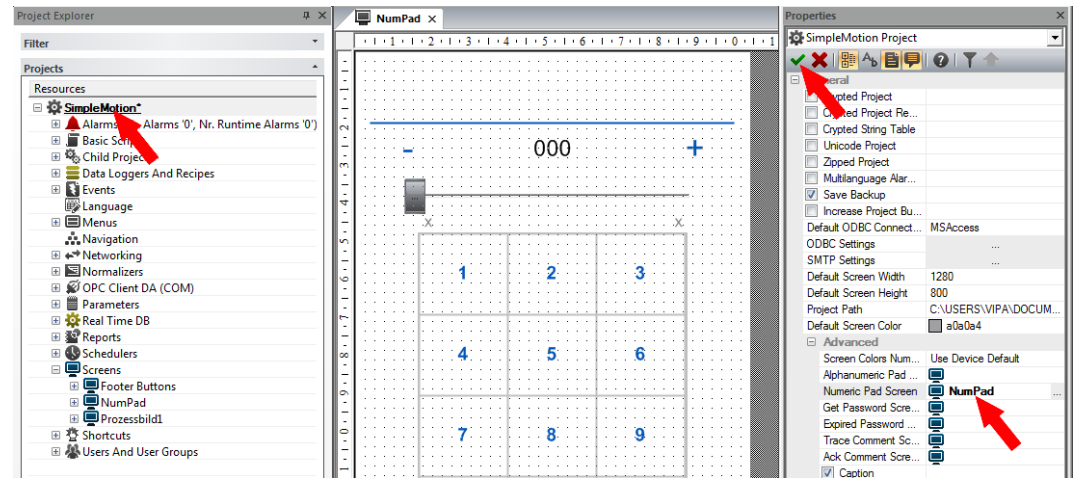

8. For optical adjustment click at 'Resourcen > SimpleMotion > Screens > NumPad > Drawing Objects > Touchpad_Num' at 'Schieberegler' (slide control) and select 'Context menu → Properties'. Expand the 'Style' part and disable 'Show Bar'.

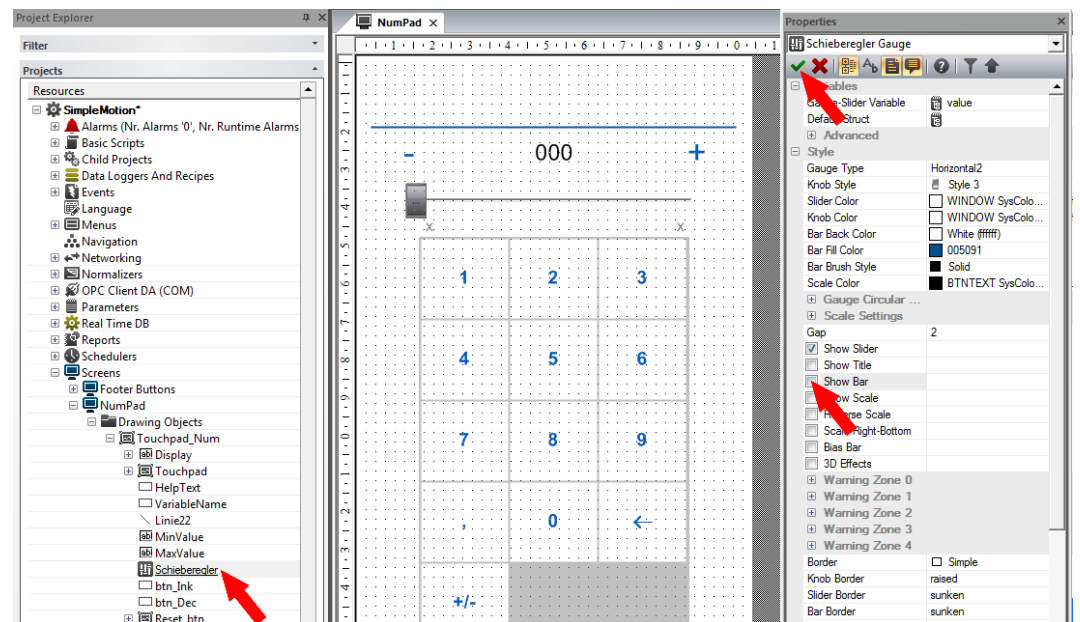

Adjust limit and default values

When a template is placed in a screen, the associated variables and structure definitions are automatically created at 'Resources > SimpleMotion > Real Time DB > Variables > VMC_AxisControl > ..._Config'. Here the following variables are created and initial values are assigned:

- AccelerationMaxValue - Maximum acceleration value
- AccelerationMinValue - Minimum acceleration value
- DecelerationMaxValue - Maximum delay value
- DecelerationMinValue - Minimum delay value
- HomePosMaxValue - Maximum home position
- HomePosMinValue - Minimum home position
- JogAccelerationMaxValue - Maximum acceleration value jog mode
- JogAccelerationMinValue - Minimum acceleration value jog mode
- JogDecelerationMaxValue - Maximum delay value jog mode
- JogDecelerationMinValue - Minimum delay value jog mode
- PositionMaxValue - Maximum position value
- PositionMinValue - Minimum position value
- VelocityMaxValue - Maximum speed value
- VelocityMinValue - Minimum speed value

→ To adjust limit and default values click at 'Resources > SimpleMotion > Real Time DB > Variables > VMC_AxisControl > ..._Config' and select 'Context menu → Properties'.

⇒ You can adjust the corresponding values at 'Engineering Data'. Confirm with  your settings.

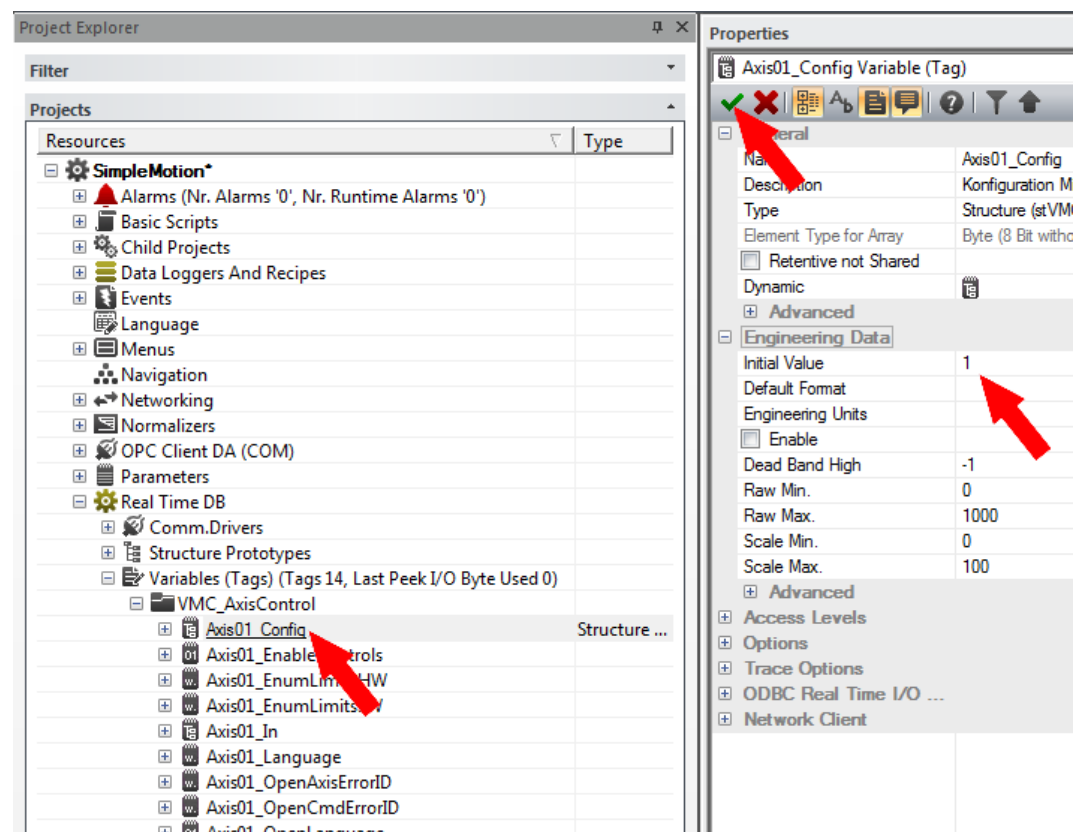

Adjust technical units

When a template is placed in a process picture, the associated variables are automatically generated with their technical units. These can be customized via the properties.

→ To adapt the technical units, e.g. for speed, click at *'Resources > SimpleMotion > Real Time DB > Variables > VMC_AxisControl > ..._Out > Members > Velocity'* and select *'Context menu → Properties'*.

⇒ You can adjust the corresponding values at *'Engineering Data'*. Confirm with  your settings.

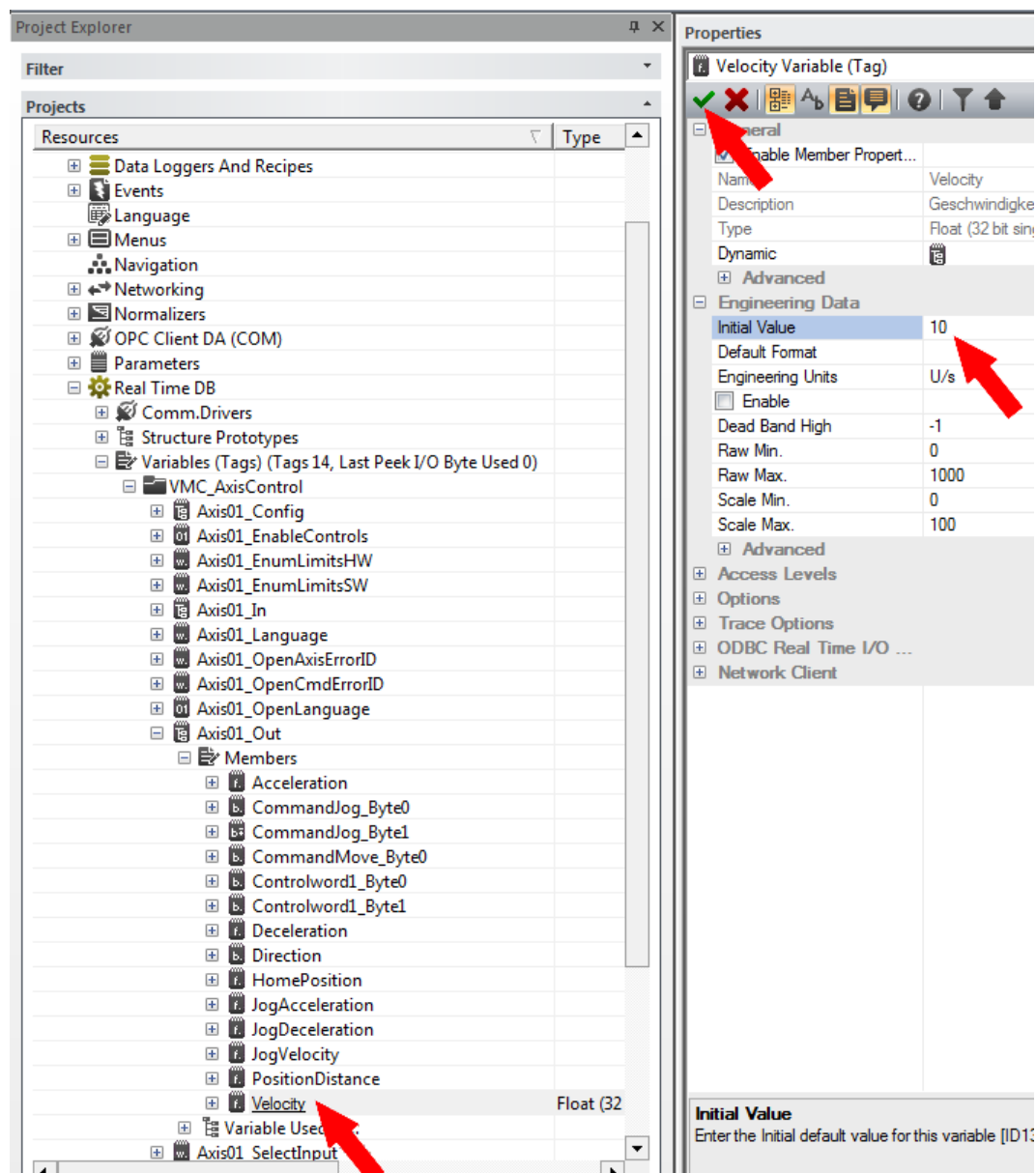

The screenshot displays the Movicon software interface. On the left, the **Project Explorer** window shows a tree view of the project structure. Under **Variables (Tags) > VMC_AxisControl > Members**, the **Velocity** tag is selected. On the right, the **Properties** window is open for the **Velocity Variable (Tag)**. The **Engineering Data** section is expanded, showing the following settings:

Property	Value
Initial Value	10
Default Format	
Engineering Units	U/s
Enable	<input type="checkbox"/>
Dead Band High	-1
Raw Min.	0
Raw Max.	1000
Scale Min.	0
Scale Max.	100

Red arrows in the image point to the **Velocity** tag in the Project Explorer, the **Initial Value** field (set to 10), and the **Engineering Units** field (set to U/s).

Controlling the drive via HMI > Modify the project in Movicon

Manually add communication driver

Instead of using the wizard, you can also manually add the communication driver:

1. Click at 'Resources > SimpleMotion > Real Time DB' at 'Comm.Drivers' and select 'Context menu → Add new Comm.Driver'.

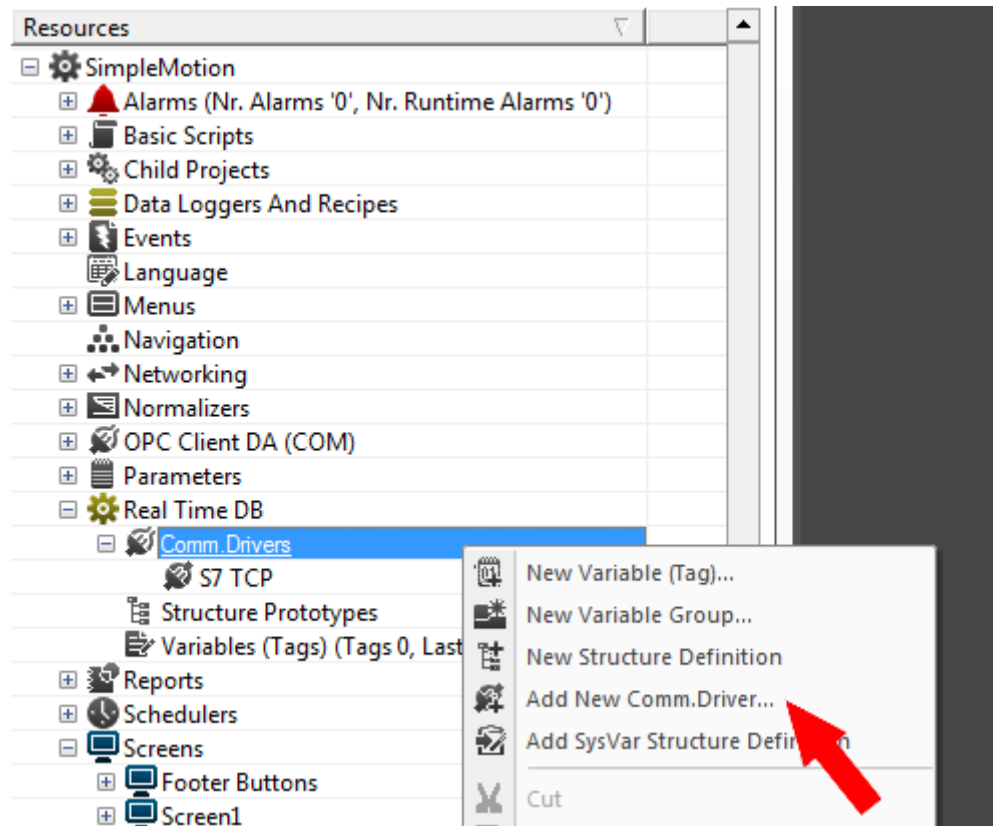

⇒ The dialog window 'New comm. I/O Driver' is opened.

2. ➤ Since the connection to the CPU is via TCP/IP, enable in the 'List available comm drivers' the driver 'VIPA' > 'Ethernet S7 TCP' and click at [Next].

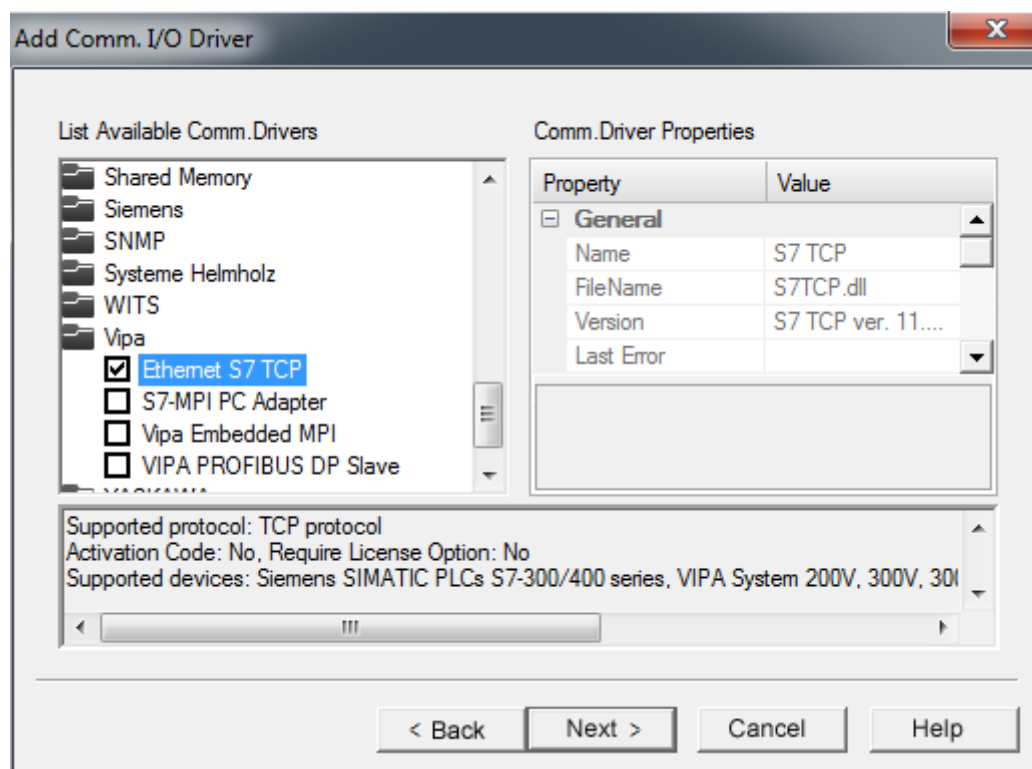

- ⇒ The communication driver 'S7 TCP' is listed at 'Resources > SimpleMotion > Real Time DB > Comm.Drivers'.
3. ➤ Click at 'S7 TCP' and select 'Context menu → Comm. I/O Driver Settings'.
 - ⇒ The 'S7 TCP' dialog opens.
 4. ➤ Select the register 'Stations'.

Controlling the drive via HMI > Modify the project in Movicon

5. ➤ To add a new station, click [+ Add].

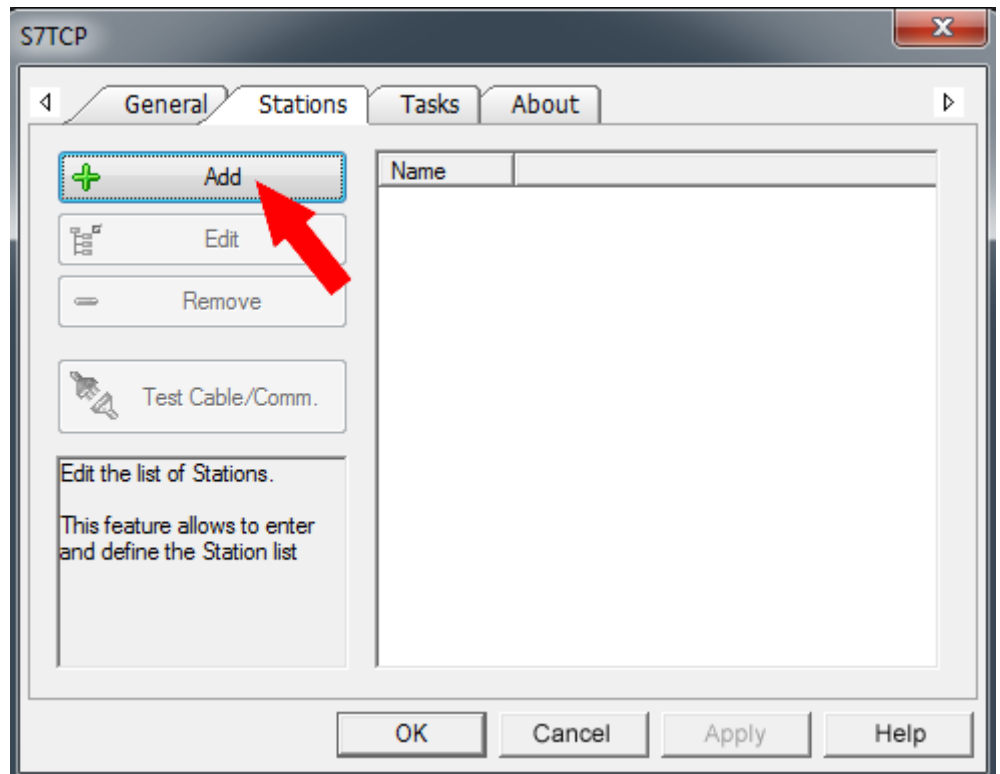

⇒ The dialog 'Station Properties' opens.

6. ➤ Enter a station name at 'Station Name'. Allowed characters: A-Z, a-z, 0-9 space and the separators "_" and "-"
Enter at 'Server Address' the IP address of your CPU and click at [OK].

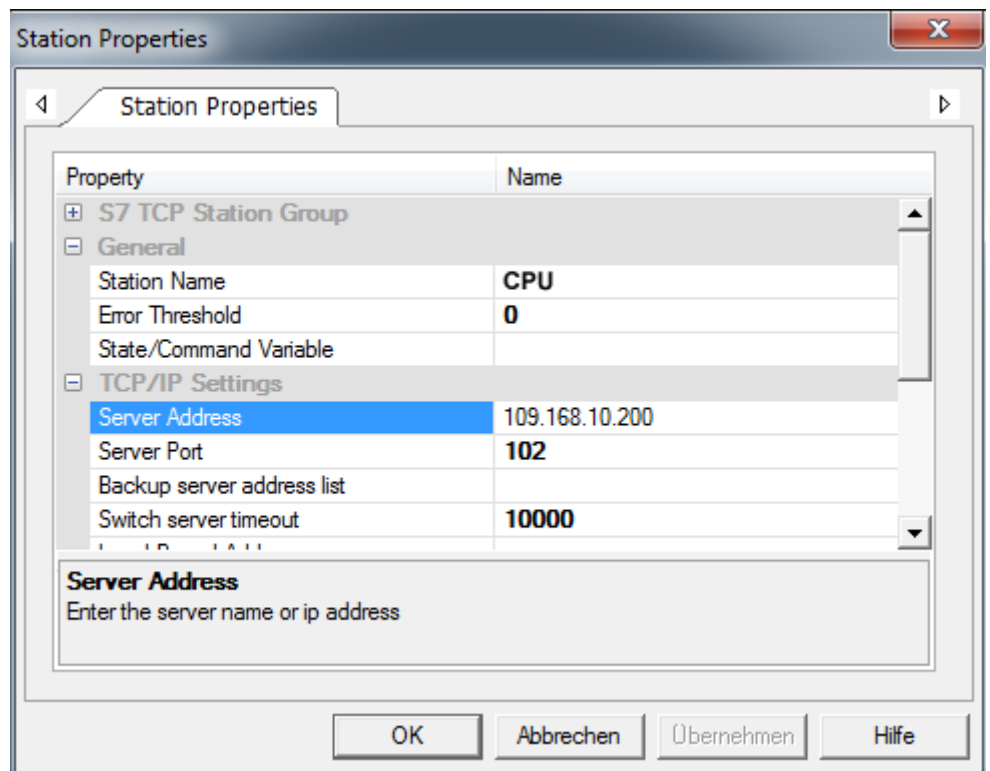

7. ➤ Negate the query for importing variables from the PLC database and close the 'S7 TCP' dialog with [OK].

13.8.4 Commissioning

13.8.4.1 Transfer project to target device

You can transfer your project to your panel via Ethernet. The Movicon runtime version, which is pre-installed in your panel, will make your project executable.

1. ➤ Connect your PC and your panel via Ethernet.
2. ➤ Start your panel and determine the IP address of your panel in the 'Startup-Manager'.
3. ➤ Call in your 'Startup-Manager' the 'Autostart' menu item.
4. ➤ To enable Movicon to transfer a project to your panel via Ethernet, you have to enable the option 'Movicon TCP Upload Server' at 'Autostart'.

The screenshot shows two configuration screens. The top screen, titled 'Runtime Start', has three sections: 'Runtime Path' with a text field containing '\Flashdisk\MovCE\MovCE.exe[11.4.1150.3]' and a browse button; 'Project Path / Parameter' with a text field containing '\Flashdisk\Movproj\SIM3\sim3.movprj' and a browse button; and 'Delay Time [seconds]' with a numeric input field set to '5' and '+' and '-' buttons. The bottom screen, titled 'Autostart', has a table with columns 'Name' and 'Action'. The table contains two rows: 'Icon Desktop' with action 'copy' and 'Icon Program' with action 'copy'. To the right of the table are '+', '-', and 'Edit' buttons. Below the table are three checkboxes: 'VNC Server' (unchecked), 'Autostart VipaStartup' (checked), and 'Movicon TCP Upload Server' (unchecked). A 'Back' button is located at the bottom right.

⇒ Confirm the query for activation.

5. ➤ Now you can transfer your project to your panel from Movicon. For this in Movicon click in 'Resources' at 'SimpleMotion' and select 'Context menu' → 'Upload project to Device/FTP'.

⇒ The Transfer dialog opens.

6. ➤ Select at 'PlugIn Type' 'TCP'.

Specify at 'Server' the IP address of the panel.

Enter at 'User name' and 'Password' the access for your panel.

The following access data are used per default:

- Username: wince
- Password: vipatp

Specify at 'Upload Device Path' you memory card and create a new project directory.

7. ➤ Start the transfer with [Upload project].
8. ➤ After successful transfer, you can add your project on the panel in the autostart directory and start it up.



CAUTION!

Please always observe the safety instructions for your drive, especially during commissioning!

13.8.4.2 Controlling the VMC_AxisControl via the panel

13.8.4.2.1 Commissioning

It is assumed that you have set up your application and you can control your drive with the VMC_AxisControl function block.

➔ Connect your CPU to your panel and turn on your application.

⇒ The panel starts with the screen to control your drive.

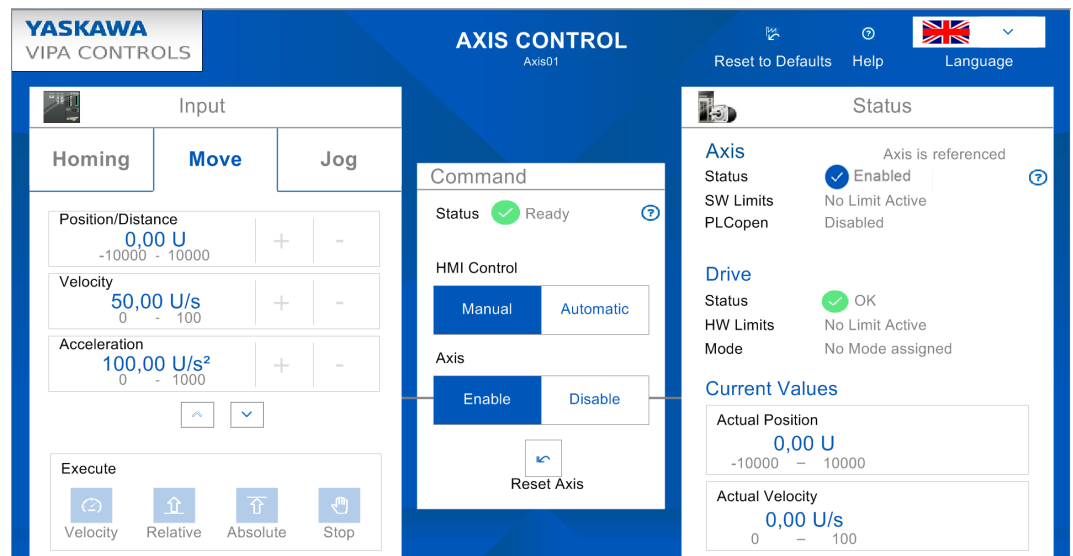

In order to control your drive via the panel, you have to switch 'HMI Control' to [Manual]. If the status does not return any errors, you can activate the drive with [Enable] for the control. You can now control your drive via the corresponding buttons.

13.8.4.2.2 Operation

User panel

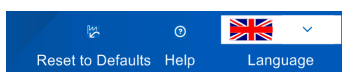

'Reset to Defaults'

- By 'Reset to Defaults' the following values are reset to default values of the application, which you can adapt accordingly as described above:
 - Velocity: 50U/s
 - Acceleration/Deceleration: 100U/s²
 - Position/Home Position: 0U

'Help'

- You can access your own help file via 'Help'. This is to be integrated within Movicon accordingly.

'Language'

- You can use 'Language' to specify the appropriate language for the user interface.

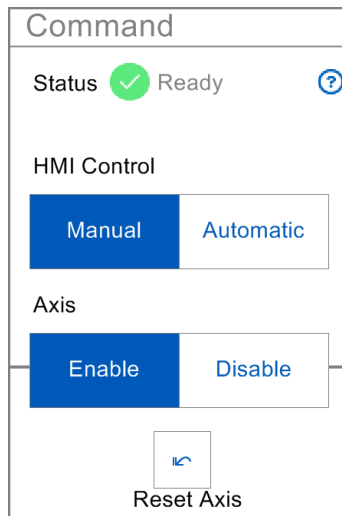
'Command'

- **'Status'**
 - Here you can see the current status of your driving command.
- **'HMI Control'**
 - **'Manual'**: When activated, the drive can be controlled via the panel.
 - **'Automatic'**: In the activated state, the drive is controlled via the PLC program of your CPU and can not be influenced by the panel.
- **'Axis'**
 - **'Enable'**: The drive is enabled in the activated state and when **'Manual'** or **'HMI Control'** is activated and you can control this via the **'Input'** area.
 - **'Disable'**: When activated, the drive is disabled and no control is possible.
- **'Reset Axis'**
 - On error, the control buttons become inactive. With **'Reset Axis'** you can acknowledge error messages and reactivate buttons.

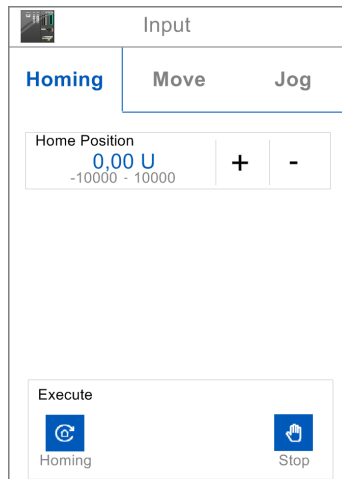
'Input'**'Homing'**

- You can use the input field or [+] and [-] to specify a homing position and move to this via **'Execute > Homing'** as a reference point.
- You can stop the homing with **'Execute > Stop'**.

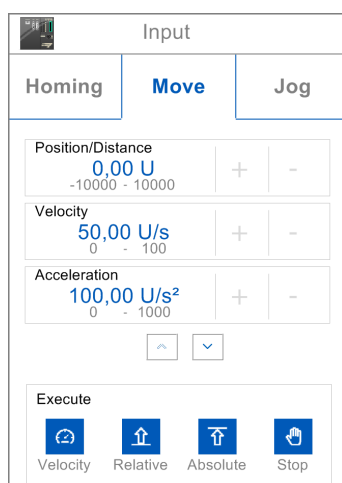
**'Move'**

- Via the corresponding input field or [+] and [-] you can specify **'Position/Distance'**, **'Velocity'**, **'Acceleration'** and **'Deceleration'** and execute them via the corresponding driving command at **'Execute'**. Use [v] to navigate down.
 - **'Velocity'**: When actuated, the drive executes the drive command at a constant velocity.
 - **'Relative'**: When actuated, the drive moves to the relative position, which can be pre-set at **'Position/Distance'**.
 - **'Absolute'**: When actuated, the drive moves to the absolute position, which can be pre-set at **'Position/Distance'**.
 - **'Stop'**: When actuated, the drive is stopped.
 - **'Current direction'**: When activated, the current drive direction is used.
 - **'Shortest distance'**: When activated, the shortest distance to the specified position is used.
 - **'Negative direction'**: When activated, the negative drive direction is used.
 - **'Positive direction'**: When activated, the positive drive direction is used.

Controlling the drive via HMI > Commissioning

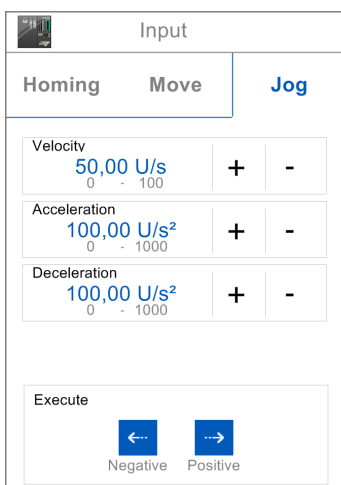
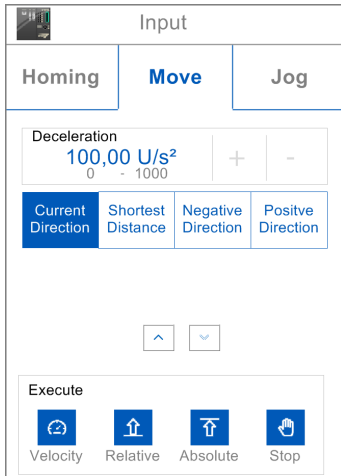
**'Jog'**

- Via the corresponding input field or [+] and [-] you can specify 'Velocity', 'Acceleration' and 'Deceleration' and execute the according drive command to positive respectively negative direction via the direction buttons at 'Execute'.
- As long as you press one of the direction buttons, the drive is accelerated to the required speed with the specified acceleration.
- When the direction button is released, the drive is stopped with the specified deceleration.

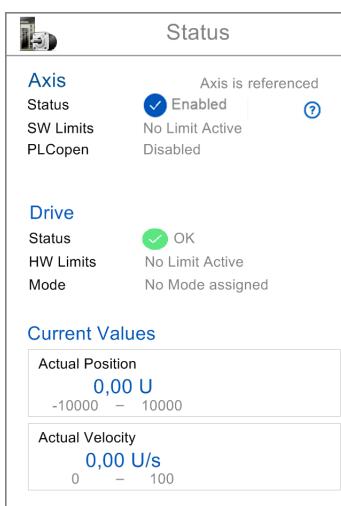
'Status'**'Axis'**

- 'Status' The status of your axis is shown here.
 - 'Enabled': The axis is switched on.
 - 'Ready': The axis is ready to switch on.
 - 'Disabled': The axis is disabled.
 - 'Axis error': An axis error is pending, indicating the error number. [Chap. 13.10 'ErrorID - Additional error information' page 637](#)
- 'SW Limits': As soon as SW limits exist, this is shown here.
- 'PLCopen': The PLCopen status is shown here.

'Drive'

- 'Status': The status of the drive controller is shown here.
- 'HW-Limits': Here, a possible limitation in your drive controller is shown here.
- 'Mode': Here you can get information about the currently selected drive profile.

'Current Values'

- The current values of 'Position' and 'Velocity' are shown here.
- Values that are outside the defined limits are framed in red.

13.9 States and behavior of the outputs

13.9.1 States

State diagram

The *state diagram* shows all the states that an axis can assume. An axis is always in one of these states. Depending on the output state, a state change can take place automatically or via the blocks of the axis control. In principle, movement tasks are processed sequentially. You can use the following function blocks to query the state

- ↗ Chap. 13.7.3.11 'FB 812 - MC_ReadStatus - PLCopen status' page 565
- Parameter *PLCopenState* from ↗ Chap. 13.7.2.2 'FB 860 - VMC_AxisControl - Control block axis control' page 544

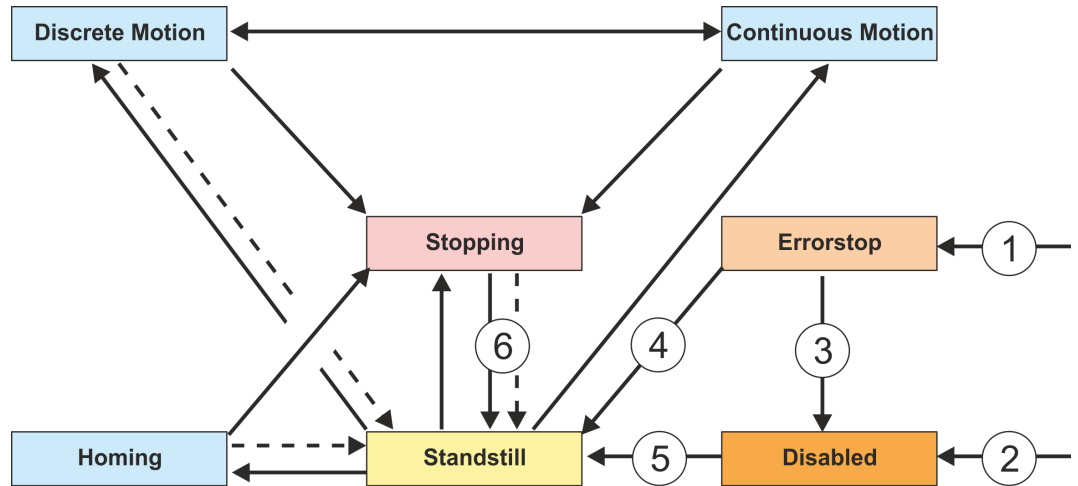

-- ➔ Return when done

- (1) From each state: An error has occurred at the axis
- (2) From each state: *MC_Power.Enable* = FALSE and there is no error on the axis
- (3) *MC_Reset* and *MC_Power.Status* = FALSE
- (4) *MC_Reset* and *MC_Power.Status* = TRUE and *MC_Power.Enable* = TRUE
- (5) *MC_Power.Enable* = TRUE and *MC_Power.Status* = TRUE
- (6) *MC_Stop.Done* = TRUE and *MC_Stop.Execute* = FALSE

There are the following states

- Disabled
 - Basic state of an axis.
 - Axis can not be moved by any function block.
- Error Stop
 - An error has occurred on the axis.
 - Axis is stopped and is blocked for further motion tasks.
 - Axis remains in this state until the error is solved and a RESET is triggered.
 - Errors on an axis are also reported via the corresponding function block.
 - Errors on a function block do not lead to this state
- Stand Still
 - Ready for motion tasks
 - There is no error on the axis
 - There are no motion tasks active on the axis
 - Axis is power supplied
- Stopping
 - Axis is currently stopped:
 - ↗ Chap. 13.7.3.5 'FB 802 - MC_Stop - stop axis' page 553
 - ↗ Chap. 13.7.2.2 'FB 860 - VMC_AxisControl - Control block axis control' page 544
 - The *Stopping* state is active as long as a Stop command is active (*Execute* = 1). Even if the axis is already stopped. Then the state automatically changes to *Standstill*.

States and behavior of the outputs > Replacement behavior of motion jobs

- Homing
 - The axis is currently homing:
 - ↳ Chap. 13.7.3.4 'FB 801 - MC_Home - home axis' page 551
 - ↳ Chap. 13.7.2.2 'FB 860 - VMC_AxisControl - Control block axis control' page 544
 - As soon as the axis is homed, the state automatically changes to *Standstill*.
- Discrete Motion
 - The axis is currently executing a motion task:
 - ↳ Chap. 13.7.3.9 'FB 808 - MC_MoveAbsolute - move axis to absolute position' page 561
 - ↳ Chap. 13.7.3.7 'FB 804 - MC_MoveRelative - move axis relative' page 557
 - ↳ Chap. 13.7.3.6 'FB 803 - MC_Halt - holding axis' page 555
 - ↳ Chap. 13.7.2.2 'FB 860 - VMC_AxisControl - Control block axis control' page 544
 - As soon as the target of the movement task is reached, the state automatically changes to *Standstill*.
- Continuous Motion
 - The axis performs a permanent movement task:
 - ↳ Chap. 13.7.3.8 'FB 805 - MC_MoveVelocity - drive axis with constant velocity' page 559
 - ↳ Chap. 13.7.2.2 'FB 860 - VMC_AxisControl - Control block axis control' page 544

13.9.2 Replacement behavior of motion jobs

Example

In the following with an example of MC_MoveRelative the replacement behavior of motion jobs is explained. ↳ Chap. 13.7.3.7 'FB 804 - MC_MoveRelative - move axis relative' page 557

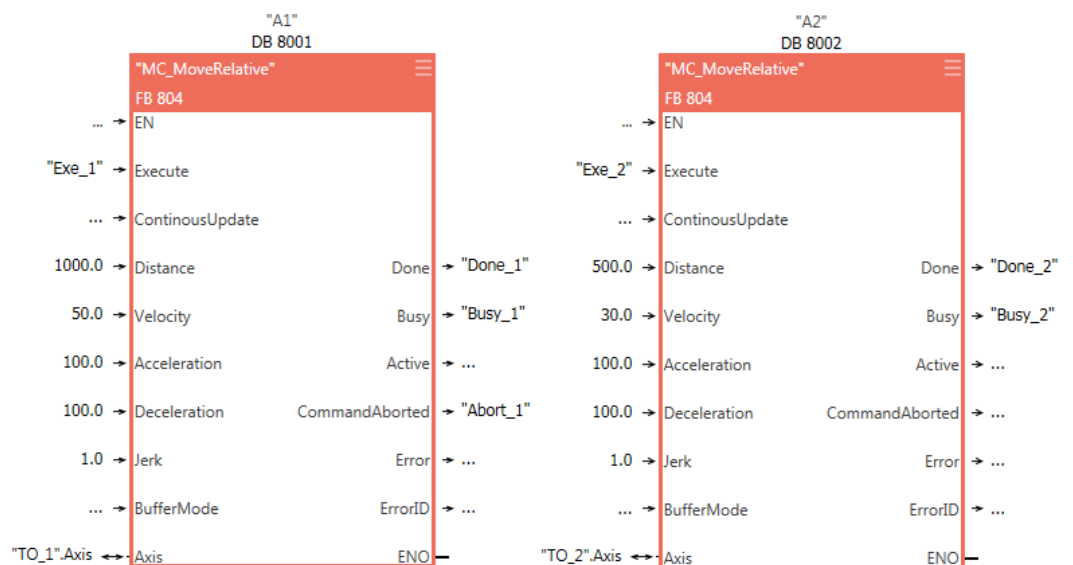

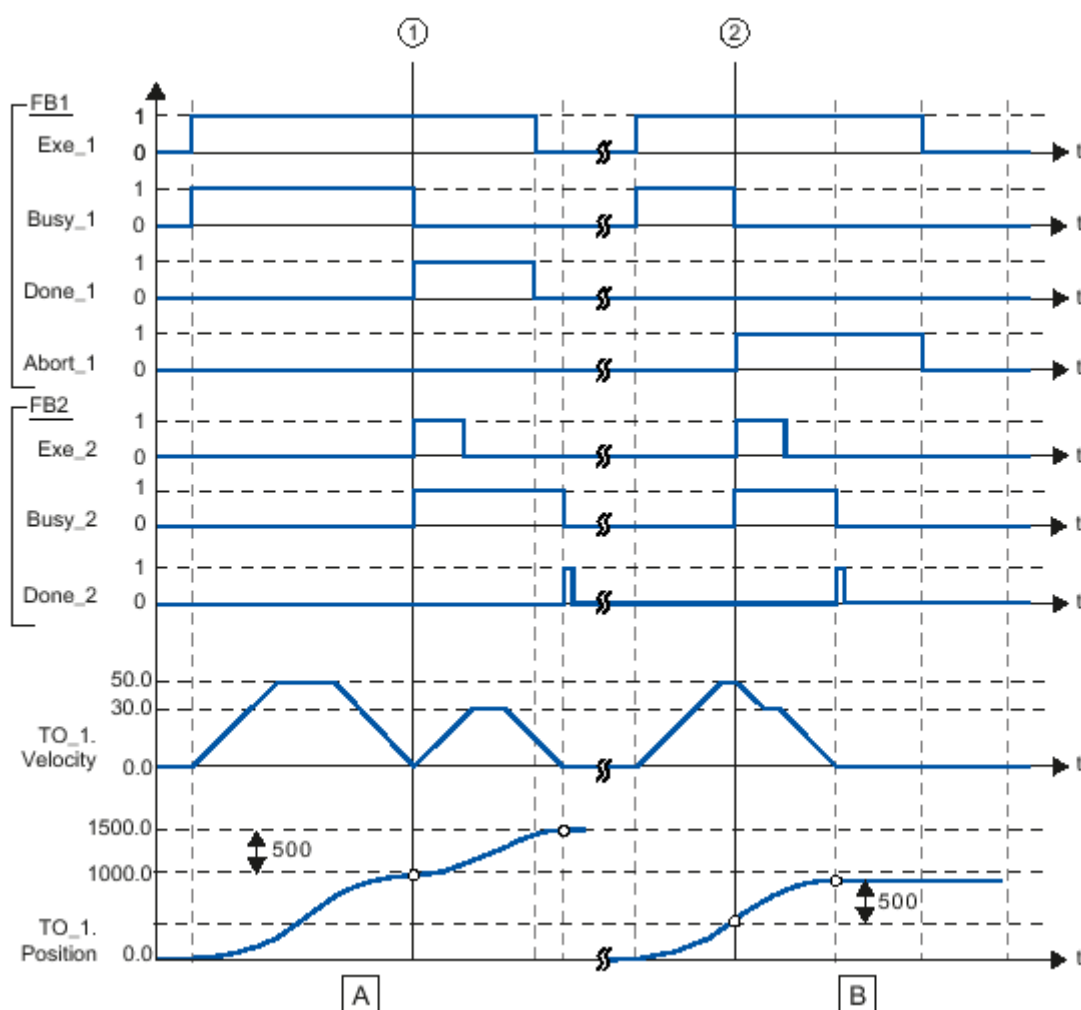

- (A) The axis is moved by the "MC_MoveRelative" job (A1) by the *Distance* 1000.0 (starting position is the position 0.0).
- (1) Reaching the target position is reported at the time (1) *Done_1*. At this time (1) a further MC_MoveRelative order (A2) is started with the route 500.0. The successful achievement of the new target position is reported via *Done_2*. Since *Exe_2* was reset before, *Done_2* is only set for one cycle
- (B) A running MC_MoveRelative job (A1) is replaced by a further MC_MoveRelative job (A2).
- (2) The abort is reported at time (2) via *Abort_1*. The axis is then moved with the new velocity by the new distance *Distance* 500.0. The successful achievement of the new target position is reported via *Done_2*.

13.9.3 Behavior of the inputs and outputs

- Exclusivity of the outputs**
- The outputs *Busy*, *Done*, *Error* and *CommandAborted* exclude each other, so at a function block only one of these outputs can be TRUE at a time.
 - As soon as the input *Execute* is TRUE, one of the outputs must be TRUE. Only one of the outputs *Active*, *Error*, *Done* and *CommandAborted* can be TRUE at one time.
- Output status**
- The outputs *Done*, *InVelocity*, *Error*, *ErrorID* and *CommandAborted* are reset with an edge 1-0 at the *Execute* input if the function block is not active (*Busy* = FALSE).
 - The command execution is not affected by an edge 1-0 of *Execute*.
 - If *Execute* is already reset during command execution, so it is guaranteed that one of the outputs is set at the end of the command for a PLC cycle. Only then the outputs are reset.
- Input parameter**
- The input parameters are taken with edge 0-1 at *Execute*.
 - To change the parameters the command must be retriggered.
 - If an input parameter is not passed to the function block, the last transferred value to this block remains valid.
 - With the first call a sensible default value must be passed.
- Position an distance**
- The input *Position* designates an absolute position value.
 - *Distance* designates a relative measure as distance between two positions.
 - Both *Position* and *Distance* are preset in technical units e.g. [mm] or [°], in accordance to the scaling of the axis.
- Parameter for the dynamic behavior**
- The dynamic parameter for *Move* functions are preset in engineering units with second as the time base.
If an axis is scaled in millimetres so the units are for *Velocity* [mm/s], *Acceleration* [mm/s²], and *Deceleration* [mm/s²].
- Error handling**
- All the function blocks have two fault outputs to indicate errors during command execution.
 - *Error* indicates the error and *ErrorID* shows an additional error number.
 - The outputs *Done* and *InVelocity* designate a successful command execution and are not set if *Error* becomes TRUE.
- Error types**
- Function block errors
 - Function block errors are errors that only concerns the function block and not the axis such as e.g. incorrect parameters.
 - Function block errors need not be explicitly reset , but will automatically reset when the input *Execute* is reset.
 - Communication errors
 - Communication error such as e.g. the function block can not address the axis.
 - Communication errors often indicate an incorrect configuration or parametrization.
 - A reset is not possible, but the function block can be retriggered after the configuration has been corrected.
 - Axis errors
 - Axis errors usually occur during the move such as e.g. position error.
 - An axis error must be reset by MC_Reset.

- Behavior of the *Done* output**
- The *Done* output is set, when a command was successfully executed.
 - When operating with multiple function blocks at one axis and the current command is interrupted by another block, the *Done* output of the first block is not set.
- Behavior of the *CommandAborted* output**
- *CommandAborted* is set when a command is interrupted by another block.
- Behavior of the *Busy* output**
- The *Busy* output indicates that the function block is active.
 - *Busy* is immediately set with edge 0-1 of *Execute* and will not be reset until the command was completed successfully or failed.
 - As long as *Busy* is TRUE, the function block must be called cyclically to execute the command.
- Behavior of the *Active* output**
- If the motion of an axis is controlled by several function blocks, the *Active* output of each block indicates that the command is executed by the axis.
- Enable-Input* and *Valid* output**
- In contrast to *Execute* the *Enable* input causes that an action is permanently and continuously executed, as long as *Enable* is TRUE. MC_ReadStatus e.g. cyclically refreshes for example the status of an axis as long as *Enable* is TRUE.
 - A function block with a *Enable* input indicates by the *Valid* output that the data of the outputs are valid. However, the data can constantly be updated during *Valid* is TRUE.
- BufferMode**
- *BufferMode* is not supported.

13.10 ErrorID - Additional error information

ErrorID	Description	Remark
0x0000	No Error	
0x8y24	Error in block parameter y, with y: <ul style="list-style-type: none"> ■ 1: Error in PROTOKOLL ■ 2: Error in PARAMETER ■ 3: Error in BAUDRATE ■ 4: Error in CHARLENGTH ■ 5: Error in PARITY ■ 6: Error in STOPBITS ■ 7: Error in FLOWCONTROL (parameter missing) 	VMC_ConfigMaster_RTU
0x8001	Invalid value at parameter <i>Position</i> .	
0x8002	Invalid value at parameter <i>Distance</i> .	
0x8003	Invalid value at parameter <i>Velocity</i> .	
0x8004	Invalid value at parameter <i>Acceleration</i> .	
0x8005	Invalid value at parameter <i>Deceleration</i> .	
0x8007	Invalid value at parameter <i>ContinuousUpdate</i> .	
0x8008	Invalid value at parameter <i>BufferMode</i> .	
0x8009	Invalid value at parameter <i>EnablePositive</i> .	
0x800A	Invalid value at parameter <i>EnableNegative</i> .	

ErrorID - Additional error information

ErrorID	Description	Remark
0x800B	Invalid value at parameter <i>MasterOffset</i> .	
0x800C	Invalid value at parameter <i>SlaveOffset</i> .	
0x800D	Invalid value at parameter <i>MasterScaling</i> .	
0x800E	Invalid value at parameter <i>SlaveScaling</i> .	
0x800F	Invalid value at parameter <i>StartMode</i> .	
0x8010	Invalid value at parameter <i>ActivationMode</i> .	
0x8011	Invalid value at parameter <i>Source</i> .	
0x8012	Invalid value at parameter <i>Direction</i> .	
0x8014	Invalid parameter of physical axis.	Mc_ReadParameter
0x8015	Invalid index or subindex.	Mc_ReadParameter
0x8016	Invalid parameter length.	Mc_ReadParameter
0x8017	Invalid LADDR.	Mc_ReadParameter
0x8018	Invalid value at parameter <i>RatioDenominator</i> .	MC_GearIn
0x8019	Invalid value at parameter <i>RatioNumerator</i> .	MC_GearIn
0x801A	Unknown parameter number.	Mc_ReadParameter, MC_WriteParameter
0x801B	Parameter can not be written, parameter is write protected	MC_WriteParameter
0x801C	Parameter communication with unknown mode.	MC_Home, MC_WriteParameter
0x801D	Parameter communication with general error. The cause of the error is not described in detail.	
0x801E	SDO parameter value out of range.	MC_Home, MC_WriteParameter
0x801F	The Type in ANY is not BYTE.	Read/write parameter
0x8020	Different configuration of the user units in cam and master axis.	
0x8021	Different configuration of the user units in cam and slave axis.	
0x8022	There is no PROFIBUS/PROFINET device at the logical address specified in LADDR, from which you can read consistent data.	Read/write parameter
0x8023	An access error has been detected when accessing an I/O device.	Read/write parameter
0x8024	Slave error at external DP slave.	Read/write parameter
0x8025	System error at external DP slave.	Read/write parameter
0x8026	System error at external DP slave.	Read/write parameter
0x8027	The data haven't yet been read by the module.	Read/write parameter
0x8028	System error at external DP slave.	Read/write parameter
0x8029	Attempt to write a read only object.	Read/write parameter
0x802A	Attempt to read a write only object.	Read/write parameter
0x802B	Unsupported access to an object.	Read/write parameter
0x802C	Wrong data type.	Read/write parameter
0x802D	Error in device profile.	Read/write parameter

ErrorID - Additional error information

ErrorID	Description	Remark
0x802E	Error command type.	Read/write parameter
0x802F	No system resources available.	Read/write parameter
0x8030	Invalid value at parameter <i>Hardware</i> (1 = SLIO CP; 2 = VIPA CPU).	Modbus; Init
0x8031	Invalid value at parameter <i>UnitId</i> .	Modbus; Init
0x8032	Invalid value at parameter <i>UserUnitsVelocity</i> (0 = Hz, 1 = %, 2 = RPM).	Modbus; Init
0x8033	Invalid value at parameter <i>UserUnitsAcceleration</i> (0 = 0.00s, 1 = 0.0s).	Modbus; Init
0x8034	Invalid value at parameter <i>MaxVelocityApp</i> (must be > 0).	Modbus; Init
0x8035	Error while read access at <i>MonitorData</i> .	Modbus; Init
0x8036	Error while read access at <i>NumberOfPoles</i> .	Modbus; Init
0x8037	Error while write access to <i>UserUnitsVelocity</i> .	Modbus; Init
0x8038	Error while read access at <i>MinOutputFrequency</i> .	Modbus; Init
0x8039	Error while read access at <i>MaxOutputFrequency</i> .	Modbus; Init
0x803A	Error while write access to <i>StoppingMethodSelection</i> .	Modbus; Init
0x803B	Error while write access to <i>UserUnitsAcceleration</i> .	Modbus; Init
0x8041	Invalid value at parameter <i>AccelerationTime</i> .	Modbus V1000
0x8042	Invalid value at parameter <i>DecelerationTime</i> .	Modbus V1000
0x8043	Invalid value at parameter <i>JogAccelerationTime</i> .	Modbus V1000
0x8044	Invalid value at parameter <i>JogDecelerationTime</i> .	Modbus V1000
0x8045	Invalid value at parameter <i>JogVelocity</i> (\leq <i>MaxVelocityApp</i>).	Modbus V1000
0x80C8	Modbus communication error: No response from the server in the defined period (timeout can be parametrized via interface).	Modbus V1000
0x809y	Error in value of the block parameter y, with y: <ul style="list-style-type: none"> ■ 1: Error in PROTOKOLL ■ 3: Error in BAUDRATE ■ 4: Error in CHARLENGTH ■ 5: Error in PARITY ■ 6: Error in STOPBITS 	VMC_ConfigMaster_RTU
0x8092	Access error on parameter DB (DB too short).	VMC_ConfigMaster_RTU
0x809A	Interface not available or used with PROFIBUS.	VMC_ConfigMaster_RTU
0x8101	No cyclic communication with axis possible.	
0x8102	Command is in current PLCopen-State not allowed.	
0x8103	Command is not supported by the axis.	
0x8104	Axis is not ready to switch on, possible reasons: <ul style="list-style-type: none"> ■ Communication to the axis is not ready. ■ Drive is not in status 'switched on' → reset drive error possibly with MC_Reset. ■ Communication was interrupted, e.g. by CPU power cycle. Reset error with MC_Reset. 	<i>PreOperational</i> has also to be set in <i>Operational</i> .

ErrorID - Additional error information

ErrorID	Description	Remark
0x8105	Command is not supported by virtual axes.	
0x8106	PLCopen-State is not defined.	
0x8107	Command is not permitted if drive is deactivated.	VMC_AxisControl_PT, ModbusV1000
0x8188	Modbus communication error: Internal error MB_FUNCTION invalid.	Modbus V1000
0x8189	Modbus communication error: Internal error MB_DATA_ADDR invalid.	Modbus V1000
0x818A	Modbus communication error: Internal error MB_DATA_LEN invalid.	Modbus V1000
0x818B	Modbus communication error: Internal error MB_DATA_PTR invalid.	Modbus V1000
0x8201	Command cannot be executed temporarily because of lack of internal resources (no free slot in CommandBuffer).	
0x8202	Error when writing the offset for homing (no free slot in the CommandBuffer).	DriveManager → Homing (active command)
0x8210	Modbus communication error: The hardware is incompatible with the Modbus RTU/TCP block library.	Modbus V1000
0x828y	Error in parameter y of DB parameters, with y: <ul style="list-style-type: none"> ■ 1: Error in 1. Parameter ■ 2: Error in the 2. Parameter ■ ... 	VMC_ConfigMaster_RTU
0x8301	No cyclic communication with master axis possible.	
0x8302	Command is in current PLCopen-State of the master axis not allowed.	
0x8303	Command is not supported by the master axis.	
0x8304	Master axis is not in status <i>Pre-Operational</i> .	
0x8305	Master axis data block number has been changed.	
0x8306	Communication errors at the master axis. Slave axis is stopped with fast stop.	
0x8311	No cyclic communication with slave axis possible.	
0x8312	Command is in current PLCopen-State of the slave axis not allowed.	
0x8313	Command is not supported by the slave axis.	
0x8314	Slave axis is not in status <i>Pre-Operational</i> .	
0x8315	Slave axis data block number has been changed.	
0x8321	Coupling with <i>StartMode</i> = relative and <i>ActivationMode</i> = nextcycle is not permitted.	
0x8322	Coupling or switching with <i>StartMode</i> = absolute and <i>ActivationMode</i> = nextcycle is not permitted.	
0x8323	Switching with a different <i>StartMode</i> (<i>StartMode</i> of the coupling is to be used).	

ErrorID - Additional error information

ErrorID	Description	Remark
0x8331	MC_CamIn is not active.	
0x8332	MC_GearIn is not active.	
0x8340	Invalid value at TriggerInput.Probe.	MC_TouchProbe and MC_Abort-Trigger
0x8341	Invalid value at TriggerInput.Source.	MC_TouchProbe and MC_Abort-Trigger
0x8342	Invalid value at TriggerInput.TriggerMode.	MC_TouchProbe and MC_Abort-Trigger
0x8350	Invalid value at VelocitySearchSwitch.	Homing, initialization
0x8351	Invalid value at VelocitySearchZero.	Homing, initialization
0x8352	Invalid combination of inputs.	Homing, initialization
0x8360	The CPU does not support Pulse Train.	VMC_AxisControl_PT
0x8361	Wrong value in <i>S_ChannelNumberPWM</i> .	VMC_AxisControl_PT
0x8362	General error in Pulse Train output.	VMC_AxisControl_PT
0x8363	Move command with the <i>StopExecute</i> set.	VMC_AxisControl_PT, ModbusV1000
0x8381	Modbus communication error: Server returns Exception code 01h.	Modbus V1000
0x8382	Modbus communication error: Server returns Exception code 03h or wrong start address.	Modbus V1000
0x8383	Modbus communication error: Server returns Exception code 02h.	Modbus V1000
0x8384	Modbus communication error: Server returns Exception code 04h.	Modbus V1000
0x8386	Modbus communication error: Server returns wrong function code.	Modbus V1000
0x8388	Modbus communication error: Server returns wrong value or wrong number.	Modbus V1000
0x8400	MC_Power: Unexpected Drive-State Drive-State <> Operation enabled	MC_Power
0x8401	MC_Power: Unexpected Drive-State Drive-State = Quick stop active	MC_Power
0x8402	MC_Power: Unexpected Drive-State Drive-State = Fault reaction active	MC_Power
0x8403	MC_Power: Unexpected Drive-State Drive-State = Fault	MC_Power
0x8410	Timeout while trying to reset the drive.	Kernel FB --> MC_Reset
0x8500	Wrong value in <i>EncoderType</i> (1 or 2).	Init block
0x8501	Wrong value in <i>EncoderResolutionBits</i> (>0 and ≤32).	Init block
0x8502	Wrong value in <i>LogicalAddress</i> (≥0).	Init block
0x8503	Wrong value in <i>StartInputAddress</i> (≥0).	Init block
0x8504	Wrong value in <i>StartOutputAddress</i> (≥0).	Init block

ErrorID - Additional error information

ErrorID	Description	Remark
0x8505	Wrong value in <i>FactorPosition</i> (>0.0).	Init block
0x8506	Wrong value in <i>FactorVelocity</i> (>0.0).	Init block
0x8507	Wrong value in <i>FactorAcceleration</i> (>0.0).	Init block
0x8508	Wrong value in <i>MaxVelocityApp</i> (>0.0).	Init block
0x8509	Wrong value in <i>MaxAccelerationApp</i> (>0.0).	Init block
0x850A	Wrong value in <i>MaxDecelerationApp</i> (>0.0).	Init block
0x850B	Wrong value in <i>MaxVelocityDrive</i> (>0.0).	Init block
0x850C	Wrong value in <i>MaxAccelerationDrive</i> (>0.0).	Init block
0x850D	Wrong value in <i>MaxDecelerationDrive</i> (>0.0).	Init block
0x850E	Wrong value in <i>MinPosition</i> (\geq MinUserPos).	Init block
0x850F	Wrong value in <i>MaxPosition</i> (\geq MaxUserPos).	Init block
0x8510	Wrong value in <i>M2_EncoderType</i> .	VMC_InitSigma7W_EC
0x8511	Wrong value in <i>M2_EncoderResolutionBits</i> .	VMC_InitSigma7W_EC
0x8513	Wrong value in <i>M2_PdoInputs</i> .	VMC_InitSigma7W_EC
0x8514	Wrong value in <i>M2_PdoOutputs</i> .	VMC_InitSigma7W_EC
0x8515	Wrong value in <i>M2_FactorPosition</i> .	VMC_InitSigma7W_EC
0x8516	Wrong value in <i>M2_FactorVelocity</i> .	VMC_InitSigma7W_EC
0x8517	Wrong value in <i>M2_FactorAcceleration</i> .	VMC_InitSigma7W_EC
0x8518	Wrong value in <i>M2_MaxVelocityApp</i> .	VMC_InitSigma7W_EC
0x8519	Wrong value in <i>M2_MaxAccelerationApp</i> .	VMC_InitSigma7W_EC
0x851A	Wrong value in <i>M2_MaxDecelerationApp</i> .	VMC_InitSigma7W_EC
0x8603	Error homing at the drive, speed \neq 0.	MC_Home
0x8604	Error homing at the drive, speed = 0.	MC_Home
0x8700	Error: Invalid size.	
0x8710	SDO error: Toggle bit has not changed.	
0x8711	SDO error: SDO protocol timeout.	
0x8712	SDO error: Client / server command is not valid or unknown.	
0x8713	SDO error: Invalid block size (only in block mode).	
0x8714	SDO error: Invalid sequence number (only in block mode).	
0x8715	SDO error: CRC error (only in block mode).	
0x8716	SDO error: Out of memory.	
0x8717	SDO error: Unsupported access to an object.	
0x8718	SDO error: Attempt to read a write only object.	
0x8719	SDO error: Attempt to write a read only object.	
0x871A	SDO error: Object does not exist in the object dictionary.	
0x871B	SDO error: Object can not be mapped to a PDO.	

ErrorID - Additional error information

ErrorID	Description	Remark
0x871C	SDO error: The number and length of objects to be mapped exceeds the PDO length.	
0x871D	SDO error: General parameter incompatibility.	
0x871E	SDO error: General internal incompatibility in the device.	
0x871F	SDO error: Access failed due to a hardware error.	
0x8720	SDO error: Data type does not match, length of service parameter does not match.	
0x8721	SDO error: Data type does not match, service parameter too long.	
0x8722	SDO error: Data type does not match, service parameter too short.	
0x8723	SDO error: There is no subindex.	
0x8724	SDO error: Write access - Parameter value out of range.	
0x8725	SDO error: Write access - Parameter value out of high limit	
0x8726	SDO error: Write access - Parameter value out of low limit.	
0x8727	SDO error: Maximum value < Minimum value.	
0x8728	SDO error: General error.	
0x8729	SDO error: Unable to transfer or store data to application.	
0x872A	SDO error: Unable to transfer or store data to application because of local.	
0x872B	SDO error: Unable to transfer or store data to application because of present device state.	
0x872C	SDO error: The dynamic generation of the object dictionary failed or missing object dictionary.	
0x872D	SDO error: Unknown code.	
0x8750	Wrong value in <i>LADDR</i> .	
0x8751	Type other than BYTE in ANY pointer.	
0x8752	There is no PROFIBUS DP module or PROFINET IO device on the address, specified via <i>LADDR</i> , from which consistent data can be read.	
0x8753	Access error when accessing a PROFINET IO device.	
0x8754	Slave error on the external PROFIBUS DP slave.	
0x8755	Length of the SFB data does not match the length of the user data.	
0x8756	Error on external PROFIBUS DP slave.	
0x8757	System error on external PROFIBUS DP slave.	
0x8758	The data has not yet been read by the device.	
0x8759	System error on external PROFIBUS DP slave.	
0x875A	No system resources are available.	
0x8799	SDO error: An other error appeared, for more information, see the data of <i>Info1</i> and <i>Info2</i> .	
0x8888	Internal: BufferIndex error	VMC_AxisControl

ErrorID - Additional error information

ErrorID	Description	Remark
0xC000	Internal error: Status Init is undefined.	Modbus; Init
0xC001	Internal error: Invalid value at parameter <i>Cmd.ActiveType</i> .	Modbus V1000
0xC002	Internal Error: Invalid value at parameter <i>Cmd.State</i> .	Modbus V1000

14 Integrated Standard

14.1 System Functions

14.1.1 SFC 0 - SET_CLK - Set system clock

Description

The SFC 0 SET_CLK (set system clock) sets the time of day and the date of the clock in the CPU. The clock continues running from the new time and date.

If the clock is a master clock then the call to SFC 0 will start a clock synchronization cycle as well. The clock synchronization intervals are defined by hardware settings.

Parameters

Parameter	Declaration	Data type	Memory block	Description
PDT	INPUT	DT	D, L	Enter the new date and time at <i>PDT</i> .
RET_VAL	OUTPUT	INT	I, Q, M, D, L	When an error occurs while the function is being processed then the returned value contains the respective error code.

PDT

Date and time are entered as data type DT.

Example:

date: 04.27.2006, time: 14:15:55 → DT#2006-04-27-14:15:55.

The time can only be entered with one-second accuracy. The day of the week is calculated automatically by SFC 0.

Remember that you must first create the data type DT by means of FC 3 D_TOD_DT before you can supply it to the input parameter

(see time functions; FC 3, FC 6, FC 7, FC 8, FC 33, FC 40, FC 1, FC 35, FC 34).

RET_VAL (Return value)

Value	Description
0000h	no error
8080h	error in the date
8081h	error in the time

14.1.2 SFC 1 - READ_CLK - Read system clock

Description

The SFC 1 READ_CLK (read system clock) reads the contents of the CPU clock. This returns the current time and date.

Parameters

Parameter	Declaration	Data type	Memory block	Description
RET_VAL	OUTPUT	INT	I, Q, M, D, L	If an error occurs when this function is being processed the return value contains the error code.
CDT	OUTPUT	DT	D, L	The current date and time are available at output <i>CDT</i> .

RET_VAL (Return value) SFC 1 does not return any specific error information.

CDT The current date and time are available at output *CDT*.

14.1.3 SFC 2 ... 4 - Run-time meter

Description VIPA CPUs have 8 run-time meters.
You can use:

SFC 2	SET_RTM	set run-time meter
SFC 3	CTRL_RTM	run-time meter starting/stopping
SFC 4	READ_RTM	read run-time meter

You can use a runtime meter for a variety of applications:

- for measuring the runtime of a CPU
- for measuring the runtime of controlled equipment or connected devices.

Characteristics

When it is started, the runtime meter begins to count starting at the last recorded value. If you want it to start at a different initial value, you must explicitly specify this value with the SFC 2.

If the CPU changes to the STOP mode, or you stop the runtime meter, the CPU records the current value of the runtime meter. When a restart of the CPU is executed, the run-time meter must be restarted with the SFC 3.

Range of values The runtime meter has a range of value from 0 ... 32767 hours.

14.1.4 SFC 2 - SET_RTM - Set run-time meter

Description The SFC 2 SET_RTM (set run-time meter) sets the run-time meter of the CPU to the specified value. VIPA CPUs contain 8 run-time meters.

Parameter	Declaration	Data type	Memory block	Description
NR	INPUT	BYTE	I, Q, M, D, L, constant	Input <i>NR</i> contains the number of the run-time meter that you wish to set. Range: 0 ... 7
PV	INPUT	INT	I, Q, M, D, L, constant	Input <i>PV</i> contains the setting for the run-time meter.
RET_VAL	OUTPUT	INT	I, Q, M, D, L	The return value contains an error code if an error is detected when the function is being processed.

RET_VAL (Return value)

Value	Description
0000h	no error
8080h	Incorrect number for the run-time meter
8081h	A negative value was supplied to parameter <i>PV</i> .

14.1.5 SFC 3 - CTRL_RTM - Control run-time meter

Description The SFC 3 CTRL_RTM (control run-time meter) starts or stops the run-time meter depending on the status of input S.

Parameters

Parameter	Declaration	Data type	Memory block	Description
NR	INPUT	BYTE	I, Q, M, D, L, constant	Input <i>NR</i> contains the number of the run-time meter that you wish to set. Range: 0 ... 7
S	INPUT	BOOL	I, Q, M, D, L, constant	Input S starts or stops the run-time meter. Set this signal to "0" to stop the run-time meter. Set this signal to "1" to start the run-time meter.
RET_VAL	OUTPUT	INT	I, Q, M, D, L	The return value contains an error code if an error is detected when the function is being processed.

RET_VAL (Return value)

Value	Description
0000h	no error
8080h	Incorrect number for the run-time meter

14.1.6 SFC 4 - READ_RTM - Read run-time meter

Description The SFC 4 READ_RTM (read run-time meter) reads the contents of the run-time meter. The output data indicates the current run-time and the status of the meter ("stopped" or "started").

When the run-time meter has been active for more than 32767 hours it will stop with this value and return value *RET_VAL* indicates the error message "8081h: overflow".

Parameters

Parameter	Declaration	Data type	Memory block	Description
NR	INPUT	BYTE	I, Q, M, D, L, constant	Input <i>NR</i> contains the number of the run-time meter that you wish to read. Range: 0 ... 7
RET_VAL	OUTPUT	INT	I, Q, M, D, L	The return value contains an error code if an error is detected when the function is being processed.
CQ	OUTPUT	BOOL	I, Q, M, D, L	Output <i>CQ</i> indicates whether the run-time meter is started or stopped. <ul style="list-style-type: none"> ■ "0": the status of the run-time meter is stopped. ■ "1": the status of the run-time meter is started.
CV	OUTPUT	INT	I, Q, M, D, L	Output <i>CV</i> indicates the up to date value of the run-time meter.

RET_VAL (Return value)

Value	Description
0000h	no error
8080h	Incorrect number for the run-time meter
8081h	run-time meter overflow

14.1.7 SFC 5 - GADR_LGC - Logical address of a channel**Description**

The SFC 5 GADR_LGC (convert geographical address to logical address) determines the logical address of the channel of a I/O module.

Parameter

Parameter	Declaration	Data type	Memory block	Description
SUBNETID	INPUT	BYTE	I, Q, M, D, L, constant	area identifier
RACK	INPUT	WORD	I, Q, M, D, L, constant	Rack No.
SLOT	INPUT	WORD	I, Q, M, D, L, constant	Slot No.
SUBSLOT	INPUT	BYTE	I, Q, M, D, L, constant	Submodule slot
SUBADDR	INPUT	WORD	I, Q, M, D, L, constant	Offset in user-data address space of the module

Parameter	Declaration	Data type	Memory block	Description
RET_VAL	OUTPUT	INT	I, Q, M, D, L	The return value contains an error code if an error is detected when the function is being processed.
IOID	OUTPUT	BYTE	I, Q, M, D, L	area identifier
LADDR	OUTPUT	WORD	I, Q, M, D, L	Logical base address for the module

SUBNETID	area identifier: <ul style="list-style-type: none"> ■ "0": if the module is put locally (including expansion rack). ■ DP-master-system-ID of the respective decentralized peripheral system when the slot is located in one of the decentralized peripheral devices.
Rack	Rack No., when the address space identification is 0 Station number of the decentralized Peripheral device when falls the area identification >0
SLOT	Slot-Number
SUBSLOT	Submodule slot (when submodules cannot be inserted this parameter must be 0)
SUBADDR	Offset in user-data address space of the module
RET_VAL (Return value)	The return value contains an error code if an error is detected when the function is being processed.

Value	Description
0000h	no error
8094h	No subnet with the specified <i>SUBNETID</i> configured.
8095h	Illegal value for parameter <i>RACK</i>
8096h	Illegal value for parameter <i>SLOT</i>
8097h	Illegal value for parameter <i>SUBSLOT</i>
8098h	Illegal value for parameter <i>SUBADDR</i>
8099h	The slot has not been configured.
809Ah	The sub address for the selected slot has not been configured.

IOID	Area identifier: <ul style="list-style-type: none"> ■ 54h: peripheral input (PI) ■ 55h: peripheral output (PQ) <p>For hybrid modules the SFC returns the area identification of the lower address. When the addresses are equal the SFC returns identifier 54h.</p>
-------------	---

LADDR Logical base address for the module

14.1.8 SFC 6 - RD_SINFO - Read start information

Description The SFC 6 RD_SINFO (read start information) retrieves the start information of the last OB accessed and that has not yet been processed completely, as well as the last startup OB. These start information items do not contain a time stamp. Two identical start information items will be returned when the call is issued from OB 100.

Parameters

Parameter	Declaration	Data type	Memory block	Description
RET_VAL	OUTPUT	INT	I, Q, M, D, L	The return value contains an error code if an error is detected when the function is being processed.
TOP_SI	OUTPUT	STRUCT	D, L	Start information of the current OB
START_UP_SI	OUTPUT	STRUCT	D, L	Start information of the last OB that was started

TOP_SI and START_UP_SI This refers to two identical structures as shown below.

Structure element	Data type	Description
EV_CLASS	BYTE	Bits 3 ... 0: event identifier Bits 7 ... 4: event class 1: Start events of standard-OBs 2: Start events of synchronous-error OBs 3: Start events of asynchronous-error OBs
EV_NUM	BYTE	event number
PRIORITY	BYTE	Structure element PRIORITY shows the priority class of the current OB.
NUM	BYTE	Structure element NUM contains the number of the current OB or of the last OB started
TYP2_3	BYTE	Data identifier 2_3: identifies the information entered into ZI2_3
TYP1	BYTE	Data identifier 1: identifies the information entered into ZI1
ZI1	WORD	Additional information 1
ZI2_3	DWORD	Additional information 2_3



The content of the structure elements shown in the table above corresponds exactly with the temporary variables of an OB. It must be remembered, however, that the name and the data type of the temporary variables in the different OBs might differ. Furthermore, the call interface of the OBs also contains the date and time at which call to the OB was requested.

RET_VAL (Return value) The SFC 6 only returns general error information. No specific error information is available.

Example The OB that was called last and that has not yet been completely processed serves as OB 80; the restart OB that was started last serves as OB 100.

The following table shows the assignment of the structure elements of parameter *TOP_SI* of SFC 6 and the respective local variables of OB 80.

TOP_SI Structure element	Data type	Logical Variable	Data type
EV_CLASS	BYTE	OB100_EV_CLASS	BYTE
EV_NUM	BYTE	OB80_FLT_ID	BYTE
PRIORITY	BYTE	OB80_PRIORITY	BYTE
NUM	BYTE	OB80_OB_NUMBR	BYTE
TYP2_3	BYTE	OB80_RESERVED_1	BYTE
TYP1	BYTE	OB80_RESERVED_2	BYTE
ZI1	WORD	OB80_ERROR_INFO	WORD
ZI2_3	DWORD	OB80_ERR_EV_CLASS	BYTE
		OB80_ERR_EV_NUM	BYTE
		OB80_OB_PRIORITY	BYTE
		OB80_OB_NUM	BYTE

The following table shows the assignment of the structure elements of parameter *START_UP_SI* of SFC 6 and the respective local variables of OB 100.

START_UP_SI Structure element	Data type	Logical Variable	Data type
EV_CLASS	BYTE	OB100_EV_CLASS	BYTE
EV_NUM	BYTE	OB100_STRTUP	BYTE
PRIORITY	BYTE	OB100_PRIORITY	BYTE
NUM	BYTE	OB100_OB_NUMBR	BYTE
TYP2_3	BYTE	OB100_RESERVED_1	BYTE
TYP1	BYTE	OB100_RESERVED_2	BYTE
ZI1	WORD	OB100_STOP	WORD
ZI2_3	DWORD	OB100_STRT_INFO	DWORD

14.1.9 SFC 7 - DP_PRAL - Triggering a hardware interrupt on the DP master

Description

With SFC 7 DP_PRAL you trigger a hardware interrupt on the DP master from the user program of an intelligent slave. This interrupt starts OB 40 on the DP master. Using the input parameter *AL_INFO*, you can identify the cause of the hardware interrupt. This interrupt identifier is transferred to the DP master and you can evaluate the identifier in OB 40 (variable *OB40_POINT_ADDR*). The requested hardware interrupt is uniquely specified by the input parameters *IOID* and *LADDR*. For each configured address area in the transfer memory, you can trigger exactly one hardware interrupt at any time.

How the SFC operates

SFC 7 DP_PRAL operates asynchronously, in other words, it is executed over several SFC calls. You start the hardware interrupt request by calling SFC 7 with *REQ* = 1. The status of the job is indicated by the output parameters *RET_VAL* and *BUSY*, see Meaning of the Parameters *REQ*, *RET_VAL* and *BUSY* with Asynchronous SFCs. The job is completed when execution of OB 40 is completed on the DP master.



If you operate the DP slave as a standard slave, the job is completed as soon as the diagnostic frame is obtained by the DP master.

Identifying a job

The input parameters *IOID* and *LADDR* uniquely specify the job. If you have called SFC 7 DP_PRAL on a DP slave and you call this SFC again before the master has acknowledged the requested hardware interrupt, the way in which the SFC reacts depends largely on whether the new call involves the same job: if the parameters *IOID* and *LADDR* match a job that is not yet completed, the SFC call is interpreted as a follow-on call regardless of the value of the parameter *AL_INFO*, and the value W#16#7002 is entered in *RET_VAL*.

Parameters

Parameter	Declaration	Data Type	Memory Area	Description
REQ	INPUT	BOOL	I, Q, M, D, L, constant	<i>REQ</i> = 1: Hardware interrupt on the DP master belonging to the slave
IOID	INPUT	BYTE	I, Q, M, D, L, constant	Identifier of the address area in the transfer memory (for the perspective of the DP slave): <ul style="list-style-type: none"> ■ B#16#00: Bit15 of <i>LADDR</i> specifies whether a an input (Bit15=0) or output address (Bit15=1) is involved. ■ B#16#54: Peripheral input (PI) ■ B#16#55: Peripheral output (PQ) If a mixed module is involved, the area identifier of the lower address must be specified. If the addresses are the same, B#16#54 must be specified.
LAADR	INPUT	WORD	I, Q, M, D, L, constant	Start address of the address range in the transfer memory (from the point of view of the DP slave). If this is a range belonging to a mixed module, specify the lower of the two addresses.

Parameter	Declaration	Data Type	Memory Area	Description
AL_INFO	INPUT	DWORD	I, Q, M, D, L, constant	Interrupt ID This is transferred to the OB40 that will be started on the DP master (variable OB40_POINT_ADDR). If you operate the intelligent slave with a remote master, you must evaluate the diagnostic frame on the master.
RET_VAL	OUTPUT	INT	I, Q, M, D, L	If an error occurs while the function is being executed, the return value contains an error code.
BUSY	OUTPUT	BOOL	I, Q, M, D, L	<i>BUSY</i> = 1: The triggered hardware interrupt has not yet been acknowledged by the DP master.

RET_VAL (Return value)

Value	Description
0000h	The job was executed without errors.
7000h	First call with <i>REQ</i> = 0. No hardware interrupt request is active; <i>BUSY</i> has the value 0.
7001h	First call with <i>REQ</i> = 1. A hardware interrupt request has already been sent to the DP master; <i>BUSY</i> has the value 1.
7002h	Interim call (<i>REQ</i> irrelevant): the triggered hardware interrupt has not yet been acknowledged by the DP master; <i>BUSY</i> has the value 1.
8090h	Start address of the address range in the transfer memory is incorrect.
8091h	Interrupt is blocked (block configured by user)
8093h	The parameters <i>IOID</i> and <i>LADDR</i> address a module that is not capable of a hardware interrupt request.
80B5h	Call in the DP master not permitted.
80C3h	The required resources (memory, etc.) are occupied at this time.
80C5h	Distributed I/O device is not available at this time (i.e. station failure).
80C8h	The function is not permitted in the current DP master operating mode.
8xyyh	General error information 🔗 <i>Chap. 4.2 'General and Specific Error Information RET_VAL' page 66</i>

14.1.10 SFC 12 - D_ACT_DP - DP-Activating and Deactivating of DP slaves**Description**

With the SFC 12 D_ACT_DP, you can specifically deactivate and reactivate configured DP slaves. In addition, you can determine whether each assigned DP slave is currently activated or deactivated.

The SFC 12 cannot be used on PROFIBUS PA field devices, which are connected by a DP/PA link to a DP master system.



As long as any SFC 12 job is busy you cannot download a modified configuration from your PG to the CPU. The CPU rejects initiation of an SFC 12 request when it receives the download of a modified configuration.

Application	If you configure DP slaves in a CPU, which are not actually present or not currently required, the CPU will nevertheless continue to access these DP slaves at regular intervals. After the slaves are deactivated, further CPU accessing will stop. In this way, the fastest possible DP bus cycle can be achieved and the corresponding error events no longer occur.
Example	Every one of the possible machine options is configured as a DP slave by the manufacturer in order to create and maintain a common user program having all possible options. With the SFC 12, you can deactivate all DP slaves, which are not present at machine startup.
How the SFC operates	<p>The SFC 12 operates asynchronously, in other words, it is executed over several SFC calls. You start the request by calling the SFC 12 with <i>REQ</i> = 1.</p> <p>The status of the job is indicated by the output parameters <i>RET_VAL</i> and <i>BUSY</i>.</p>
Identifying a job	If you have started a deactivation or activation job and you call the SFC 12 again before the job is completed, the way in which the SFC reacts depends largely on whether the new call involves the same job: if the parameter <i>LADDR</i> matches, the SFC call is interpreted as a follow-on call.
Deactivating DP slaves	<p>When you deactivate a DP slave with the SFC 12, its process outputs are set to the configured substitute values or to "0" (secure state).</p> <p>The assigned DP master does not continue to address this DP slave. Deactivated DP slaves are not identified as fault or missing by the error LEDs on the DP master or CPU.</p> <p>The process image of the inputs of deactivated DP slaves is updated with 0, that is, it is handled just as for failed DP slaves.</p>



With VIPA you can not deactivate all DP slaves.

At least 1 slave must remain activated at the bus.

If you are using your program to directly access the user data of a previously deactivated DP slave, the I/O access error OB (OB 122) is called, and the corresponding start event is entered in the diagnostic buffer.

If you attempt to access a deactivated DP slave with SFC (i.e. SFC 59 RD_REC), you receive the error information in *RET_VAL* as for an unavailable DP slave.

Deactivating a DP slaves OB 85, even if its inputs or outputs belong to the system-side process image to be updated. No entry is made in the diagnostic buffer.

Deactivating a DP slave does not start the slave failure OB 86, and the operating system also does not make an entry in the diagnostic buffer. If a DP station fails after you have deactivated it with the SFC 12, the operating system does not detect the failure. As a result, there is no subsequent start of OB 86 or diagnostic buffer entry.

The station failure is detected only after the station has been reactivated and indicated in *RET_VAL*.

If you wish to deactivate DP slaves functioning as transmitters in cross communication, we recommend that you first deactivate the receivers (listeners) that detect, which input data the transmitter is transferring to its DP master. Deactivate the transmitter only after you have performed this step.

Activating DP slaves

When you reactivate a DP slave with the SFC 12 it is configured and assigned parameters by the designated DP master (as with the return of a failed station). This activation is completed when the slave is able to transfer user data.

Activating a DP slaves does not start the program error OB 85, even if its inputs or outputs belong to the system-side process image to be updated. An entry in the diagnostic buffer is also not made.

Activating a DP slave does not start the slave failure OB 86, and the operating system also does not make an entry in the diagnostic buffer.

If you attempt to use the SFC 12 to activate a slave, who has been deactivated and is physically separated from the DP bus, a supervision time of 10sec expires. After this monitoring period has expired, the SFC returns the error message 80A2h. The slave remains deactivated. If the slave is reconnected to the DP bus at a later time, it must be reactivated with the SFC 12.



Activating a DP slave may be time-consuming. Therefore, if you wish to cancel a current activation job, start the SFC 12 again with the same value for LADDR and MODE = 2. Repeat the call of the SFC 12 until successful cancellation of the activation is indicated by RET_VAL = 0.

If you wish to activate DP slaves which take part in the cross communication, we recommend that you first activate the transmitters and then the receivers (listeners).

CPU startup

At a restart the slaves are activated automatically. After the CPU start-up, the CPU cyclically attempts to contact all configured and not deactivated slaves that are either not present or not responding.



The startup OB 100 does not support the call of the SFC 12.

Parameters

Parameter	Declaration	Data type	Memory block	Description
REQ	INPUT	BOOL	I, Q, M, D, L, constant	Level-triggered control parameter <i>REQ</i> = 1: execute activation or deactivation
MODE	INPUT	BYTE	I, Q, M, D, L, constant	Job ID Possible values: 0: request information on whether the addressed DP slave is activated or deactivated. 1: activate the DP slave 2: deactivate the DP slave
LAADR	INPUT	WORD	I, Q, M, D, L, constant	Any logical address of the DP slave

Parameter	Declaration	Data type	Memory block	Description
RET_VAL	OUTPUT	INT	I, Q, M, D, L	If an error occurs while the function is processed, the return value contains an error code.
BUSY	OUTPUT	BOOL	I, Q, M, D, L	Active code: <i>BUSY</i> = 1: the job is still active. <i>BUSY</i> = 0: the job was terminated.

RET_VAL (Return value)

Value	Description
0000h	The job was completed without errors.
0001h	The DP slave is active (This error code is possible only with <i>MODE</i> = 0.)
0002h	The DP slave is deactivated(This error code is possible only with <i>MODE</i> = 0.)
7000h	First call with <i>REQ</i> = 0. The job specified with <i>LADDR</i> is not active; <i>BUSY</i> has the value 0.
7001h	First call with <i>REQ</i> = 1. The job specified with <i>LADDR</i> was triggered; <i>BUSY</i> has the value 1.
7002h	Interim call (<i>REQ</i> irrelevant). The activated job is still active; <i>BUSY</i> has the value 1.
8090h	You have not configured a module with the address specified in <i>LADDR</i> . You operate your <i>CPU</i> as I-Slave and you have specified in <i>LADDR</i> an address of this slave.
8092h	For the addressed DP slave no activation job is processed at the present. (This error code is possible only with <i>MODE</i> = 1.)
8093h	No DP slave is assigned to the address stated in <i>LADDR</i> (no projection submitted), or the parameter <i>MODE</i> is not known.
80A1h	The addressed DP slave could not be parameterized. (This error code is possible only with <i>MODE</i> = 1.) Note! The SFC supplies this information only if the activated slave fails again during parameterization. If parameterization of a single module was unsuccessful the SFC returns the error information 0000h.
80A2h	The addressed DP slave does not return an acknowledgement.
80A3h	The DP master concerned does not support this function.
80A4h	The CPU does not support this function for external DP masters.
80A6h	Slot error in the DP slave; user data access not possible. (This error code is possible only with <i>MODE</i> = 1.) Note! The SFC returns this error information only if the active slave fails after parameterization and before the SFC ends. If only a single module is unavailable the SFC returns the error information 0000h.
80C1h	The SFC 12 was started and continued with another logical address. (This error code is possible only with <i>MODE</i> = 1.)
80C3h	<ul style="list-style-type: none"> ■ Temporary resource error: the CPU is currently processing the maximum possible activation and deactivation jobs.(this error code is possible only with <i>MODE</i> = 1 and <i>MODE</i> = 2). ■ The CPU is busy receiving a modified configuration. Currently you cannot enable/disable DP slaves.

Value	Description
F001h	Not all slaves may be deactivated. At least 1 slave must remain activated.
F002h	Unknown slave address.

14.1.11 SFC 13 - DPNRM_DG - Read diagnostic data of a DP slave

Description

The SFC 13 DPNRM_DG (read diagnostic data of a DP slave) reads up-to-date diagnostic data of a DP slave. The diagnostic data of each DP slave is defined by EN 50 170 Volume 2, PROFIBUS.

Input parameter *RECORD* determines the target area where the data read from the slave is saved after it has been transferred without error. The read operation is started when input parameter *REQ* is set to 1.

The following table contains information about the principal structure of the slave diagnosis.

For additional information please refer to the manuals for the DP slaves that you are using.

Byte	Description
0	station status 1
1	station status 2
2	station status 3
3	master-station number
4	manufacturer code (high byte)
5	manufacturer code (low byte)
6 ...	additional slave-specific diagnostics

Operation

The SFC 13 is executed as asynchronous SFC, i.e. it can be active for multiple SFC-calls. Output parameters *RET_VAL* and *BUSY* indicate the status of the command.

Relationship between the call, *REQ*, *RET_VAL* and *BUSY*:

Seq. No. of the call	Type of call	REQ	RET_VAL	BUSY
1	first call	1	7001h or Error code	1 0
2 ... (n-1)	intermediate call	irrelevant	7002h	1
n	last call	irrelevant	If the command was completed without errors, then the number of bytes returned is entered as a positive number or the error code if an error did occur.	0

Parameters

Parameter	Declaration	Data type	Memory block	Description
REQ	INPUT	BOOL	I, Q, M, D, L, constant	REQ = 1: read request
LADDR	INPUT	WORD	I, Q, M, D, L, constant	The configured diagnostic address of the DP slave
RET_VAL	OUTPUT	INT	I, Q, M, D, L	return value
RECORD	OUTPUT	ANY	I, Q, M, D, L	Target area for the diagnostic data that has been read. Only data type BYTE is valid. The minimum length of the read record or respectively the target area is 6. The maximum length of the read record is 240. When the standard diagnostic data exceeds 240bytes on a norm slave and the maximum is limited to 244bytes, then only the first 240bytes are transferred into the target area and the respective overflow-bit is set in the data.
BUSY	OUTPUT	BOOL	I, Q, M, D, L	BUSY = 1: read operation has not been completed.

RECORD

The CPU tests the actual length of the diagnostic data that was read:

When the length of *RECORD*

- is less than the amount of data the data is discarded and the respective error code is entered into *RET_VAL*.
- is larger than or equal to the amount of data then the data is transferred into the target areas and *RET_VAL* is set to the actual length as a positive value.



It is essential that the matching RECORD parameters are be used for all calls that belong to a single task. A task is identified clearly by input parameter LADDR and RECORD.

Norm slaves

The following conditions apply if the amount of standard diagnostic data of the norm slave lies between 241 and 244bytes:

When the length of *RECORD*

- is less than 240bytes the data is discarded and the respective error code is entered into *RET_VAL*.
- is greater than 240bytes, then the first 240bytes of the standard diagnostic data are transferred into the target area and the respective overflow-bit is set in the data.

RET_VAL (Return value) The return value contains an error code if an error is detected when the function is being processed.

If no error did occur, then *RET_VAL* contains the length of the data that was transferred.



The amount of read data for a DP slave depends on the diagnostic status.

Error information More detailed information about general error information is to be found at the beginning of this chapter.

The SFC 13 specific error information consists of a subset of the error information for SFC 59 RD_REC.

More detailed information is available from the help for SFC 59.

14.1.12 SFC 14 - DPRD_DAT - Read consistent data

Description The SFC 14 DPRD_DAT (read consistent data of a DP norm slave) reads consistent data from a DP norm slave. The length of the consistent data must be three or more than four bytes, while the maximum length is 128Byte. Please refer to the manual of your specific CPU for details. Input parameter *RECORD* defines the target area where the read data is saved when the data transfer has been completed without errors. The length of the respective target area must be the same as the length that you have configured for the selected module.

If the module consists of a DP-norm slave of modular construction or with multiple DP-identifiers, then a single SFC 14 call can only access the data of a single module / DP-identifier at the configured start address.

SFC 14 is used because a load command accessing the periphery or the process image of the inputs can read a maximum of four contiguous bytes.

Definition *Consistent data*

Consistent data is data, where the contents belongs to the same category and that may not be separated. It is, for instance, important that data returned by analog modules is always processed consistently, i.e. the value returned by analog modules must not be modified incorrectly when it is read at two different times.

Parameters

Parameter	Declaration	Data type	Memory block	Description
LADDR	INPUT	WORD	I, Q, M, D, L, constant	Configured start address of the receive data buffer of the module from which the data must be read
RET_VAL	OUTPUT	INT	I, Q, M, D, L	The return value contains an error code if an error is detected when the function is being processed
RECORD	OUTPUT	ANY	I, Q, M, D, L	Target area for the user data that was read. The length must be exactly the same as the length that was configured for the selected module. Only data type BYTE is permitted.

RET_VAL (Return value)

value	Description
0000h	No error has occurred.
8090h	You have not configured a module for the logical base address that you have specified, or you have ignored the restrictions that apply to the length of the consistent data.
8092h	The ANY-reference contains a type that is not equal to BYTE.
8093h	No DP-module from which consistent data can be read exists at the logical address that was specified under <i>LADDR</i> .
80A0h	Incorrect start address for the address range in the transfer I/O buffer.
80B0h	Slave failure at the external DP-interface.
80B1h	The length of the specified target area is not equal to the configured user data length.
80B2h	External DP-interface system error
80B3h	External DP-interface system error
80C0h	External DP-interface system error
80C2h	External DP-interface system error
80F _x h	External DP-interface system error
87 _{xy} h	External DP-interface system error
808 _x h	External DP-interface system error

14.1.13 SFC 15 - DPWR_DAT - Write consistent data

Description

The SFC 15 DPWR_DAT (write consistent data to a DP-norm slave) writes consistent data that is located in parameter *RECORD* to the DP-norm slave. The length of the consistent data must be three or more than four bytes, while the maximum length is 128Byte. Please refer to the manual of your specific CPU for details. Data is transferred synchronously, i.e. the write process is completed when the SFC has terminated. The length of the respective source area must be the same as the length that you have configured for the selected module.

If the module consists of a DP-norm slave of modular construction, then you can only access a single module of the DP-slave.

The SFC 15 is used because a transfer command accessing the periphery or the process image of the outputs can write a maximum of four contiguous bytes.

Definition

Consistent data

Consistent data is data, where the contents belongs to the same category and that may not be separated. For instance, it is important that data returned by analog modules is always processed consistently, i.e. the value returned by analog modules must not be modified incorrectly when it is read at two different times.

Parameters

Parameter	Declaration	Data type	Memory block	Description
LADDR	INPUT	WORD	I, Q, M, D, L, constant	Configured start address of the output buffer of the module to which the data must be written.
RECORD	INPUT	ANY	I, Q, M, D, L	Source area for the user data that will be written. The length must be exactly the same as the length that was configured for the selected module. Only data type BYTE is permitted.
RET_VAL	OUTPUT	INT	I, Q, M, D, L	The return value contains an error code if an error is detected when the function is being processed.

RET_VAL (Return value)

Value	Description
0000h	No error has occurred.
8090h	You have not configured a module for the logical base address that you have specified, or you have ignored the restrictions that apply to the length of the consistent data.
8092h	The ANY-reference contains a type that is not equal to BYTE.
8093h	No DP-module to which consistent data can be written exists at the logical address that was specified under <i>LADDR</i> .
80A1h	The selected module has failed.
80B0h	Slave failure at the external DP-interface.
80B1h	The length of the specified source area is not equal to the configured user data length.
80B2h	External DP-interface system error
80B3h	External DP-interface system error
80C1h	The data of the write command that was previously issued to the module has not yet been processed.
80C2h	External DP-interface system error
80F _x h	External DP-interface system error
85 _{xy} h	External DP-interface system error
808 _x h	External DP-interface system error

14.1.14 SFC 17 - ALARM_SQ and SFC 18 - ALARM_S**Description**

Every call to the SFC 17 ALARM_SQ and the SFC 18 ALARM_S generates a message that can have an associated value. This message is sent to all stations that have registered for this purpose. The call to the SFC 17 and the SFC 18 can only be issued if the value of signal SIG triggering the message was inverted with respect to the previous call. If this is not true output parameter *RET_VAL* will contain the respective information and the message will not be sent. Input SIG must be set to "1" when the call to the SFC 17 and SFC 18 is issued for the first time, else the message will not be sent and *RET_VAL* will return an error code.



The SFC 17 and the SFC 18 should always be called from a FB after you have assigned the respective system attributes to this FB.

System resources

When generating messages with the SFC 17 and SFC 18, the operating system uses one system resource for the duration of the signal cycle.

For SFC 18 , the signal cycle lasts from the SFC call *SIG* = "1" until another call with *SIG* = "0". For SFC 17, this time period also includes the time until the incoming signal is acknowledged by one of the reported display devices, if necessary.

If, during the signal cycle, the message-generating block is overloaded or deleted, the associated system resource remains occupied until the next restart.

Message acknowledgement

Messages sent by means of the SFC 17 can be acknowledged via a display device. The acknowledgement status for the last "message entering state" and the signal status of the last SFC 17-call may be determined by means of the SFC 19 ALARM_SC.

Messages that are sent by SFC 18 are always acknowledged implicitly. The signal status of the last SFC 18-call may be determined by means of the SFC 19 ALARM_SC.

Temporarily saving

The SFCs 17 and 18 occupy temporary memory that is also used to save the last two signal statuses with a time stamp and the associated value. When the call to the SFC occurs at a time when the signal statuses of the two most recent "valid" SFC-calls has not been sent (signal overflow), then the current signal status as well as the last signal status are discarded and an overflow-code is entered into temporary memory. The signal that occurred before the last signal will be sent as soon as possible including the overflow-code.

Instance overflow

The maximum number of SFC 17- and SFC 18-calls depends on the type of CPU being used. A resource bottleneck (instance overflow) can occur when the number of SFC-calls exceeds the maximum number of dynamic instances.

This condition is indicated by means of an error condition in *RET_VAL* and via the registered display device.

Parameters

Parameter	Declaration	Data type	Memory block	Description
SIG	INPUT	BOOL	I, Q, M, D, L	The signal that triggered the message.
ID	INPUT	WORD	I, Q, M, D, L	Data channel for messages: EEEEh
EV_ID	INPUT	DWORD	Const. (I, Q, M, D, L)	Message number (0: not permitted)
SD	INPUT	ANY	I, Q, M, D, T, C	Associated value
RET_VAL	OUTPUT	INT	I, Q, M, D, L	Error information

SD

Associated value

Maximum length: 12byte

Valid data types

BOOL (bit field not permitted), BYTE, CHAR, WORD, INT, DWORD, DINT, REAL, DATE, TOD, TIME, S5TIME, DATE_AND_TIME

RET_VAL (Return value) The return value contains an error code if an error is detected when the function is being processed.

Value	Description
0000h	No error has occurred.
0001h	<ul style="list-style-type: none"> ■ The associated value exceeds the maximum length, or ■ application memory cannot be accessed (e.g. access to deleted DB). The message will be transferred. ■ The associated value points to the local data area.
0002h	Warning: the last unused message acknowledgment memory has been allocated.
8081h	The specified <i>EV_ID</i> lies outside of the valid range.
8082h	Message loss because your CPU suffers from a lack of resources that are required to generate module related messages by means of SFCs.
8083h	Message loss because a signal of the same type is already available but could not be sent (signal overflow).
8084h	The triggering signal SIG for messages has the same value for the current and for the preceding SFC 17 / SFC 18 call.
8085h	The specified <i>EV_ID</i> has not been registered.
8086h	An SFC call for the specified <i>EV_ID</i> is already being processed with a lower priority class.
8087h	The value of the message triggering signal was 0 during the first call to the SFC 17, SFC 18.
8088h	The specified <i>EV_ID</i> has already been used by another type of SFC that is currently (still) occupying memory space.
8xyyh	General error information ↪ Chap. 4.2 'General and Specific Error Information RET_VAL' page 66

14.1.15 SFC 19 - ALARM_SC - Acknowledgement state last Alarm

Description

The SFC 19 ALARM_SC can be used to:

- determine the acknowledgement status of the last SFC 17-entering-state message and the status of the message triggering signal during the last SFC 17 ALARM_SQ call
- the status of the message triggering signal during the last SFC 18 ALARM_S call.

The predefined message number identifies the message and/or the signal.

The SFC 19 accesses temporary memory that was allocated to the SFC 17 or SFC 18.

Parameters

Parameter	Declaration	Data type	Memory block	Description
EV_ID	INPUT	DWORD	I, Q, M, D, L, constant	Message number for which you want to determine the status of the signal during the last SFC call or the acknowledgement status of the last entering-state message (only for SFC 17!)
RET_VAL	OUTPUT	INT	I, Q, M, D, L	Return value
STATE	OUTPUT	BOOL	I, Q, M, D, L	Status of the message triggering signal during the last SFC call.
Q_STATE	OUTPUT	BOOL	I, Q, M, D, L	If the specified parameter <i>EV_ID</i> belongs to an SFC 18 call: "1". If the specified parameter <i>EV_ID</i> belongs to an SFC 17 call: acknowledgement status of the last entering-state message: "0": not acknowledged "1": acknowledged

RET_VAL (Return value) The return value contains an error code if an error is detected when the function is being processed.

Value	Description
0000h	No error has occurred.
8081h	The specified <i>EV_ID</i> lies outside of the valid range.
8082h	No memory is allocated to this <i>EV_ID</i> at present (possible cause: the status of the respective signal has never been "1", or it has already changed back to status "0").
8xyyh	General error information ↪ Chap. 4.2 'General and Specific Error Information RET_VAL' page 66

14.1.16 SFC 20 - BLKMOV - Block move

Description

The SFC 20 BLKMOV (block move) copies the contents of one block of memory (source field) into another block of memory (target field).

Any block of memory may be copied, with the exception of :

- the following blocks: FC, SFC, FB, SFB, OB, SDB
- counters
- timers
- memory blocks of the peripheral area.

It is also possible that the source parameter is located in another data block in load memory that is not relevant to the execution (DB that was compiled with key word UNLINKED).

Interruptibility

No limits apply to the nesting depth as long as the source field is not part of a data block that only exists in load memory. However, when interrupting an SFC 20 that copies blocks from a DB that is not relevant to the current process, then this SFC 20 cannot be nested any longer.

Parameters

Parameter	Declaration	Data type	Memory block	Description
SRCBLK	INPUT	ANY	I, Q, M, D, L	Defines the memory block that must be copied (source field). Arrays of data type STRING are not permitted.
RET_VAL	OUTPUT	INT	I, Q, M, D, L	The return value contains an error code if an error is detected when the function is being processed.
DSTBLK	OUTPUT	ANY	I, Q, M, D, L	Defines the destination memory block to which the data will be copied (target field). Arrays of data type STRING are not permitted.



Source and target field must not overlap. If the specified target field is larger than the source field then only the amount of data located in the source field will be copied. When the specified target field should, however, be smaller than the source field, then only the amount of data that the target field can accommodate will be copied.

If the type of the ANY-pointer (source or target) is BOOL, then the specified length must be divisible by 8, otherwise the SFC cannot be executed.

If the type of the ANY-pointer is STRING, then the specified length must be equal to 1.

RET_VAL (Return value)

The return value contains an error code if an error is detected when the function is being processed.

Value	Description
0000h	No error
8091h	The maximum nesting depth was exceeded

14.1.17 SFC 21 - FILL - Fill a field

Description

The SFC 21 FILL fills one block of memory (target field) with the contents of another block of memory (source field). The SFC 21 copies the contents from the source field into the specified target field until the block of memory has been filled completely.

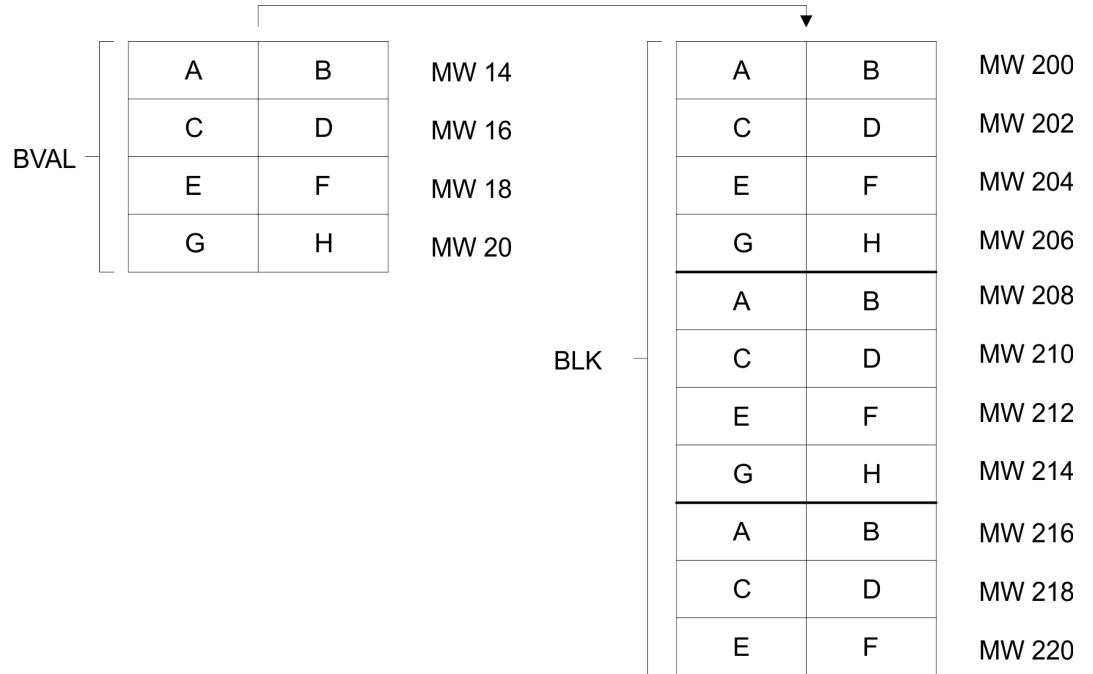

Source and target field must not overlap.

Even if the specified target field is not an integer multiple of the length of input parameter BVAL, the target field will be filled up to the last byte.

If the target field is smaller than the source field, only the amount of data that can be accommodated by the target will be copied.

Values cannot be written with the SFC 21 into:

- the following blocks: FC, SFC, FB, SFB, SDB
- counters
- timers
- memory blocks of the peripheral area.

Parameters

Parameter	Declaration	Data type	Memory block	Description
BVAL	INPUT	ANY	I, Q, M, D, L	Contains the value or the description of the source field that should be copied into the target field. Arrays of the data type STRING are not permitted.
RET_VAL	OUTPUT	INT	I, Q, M, D, L	The return value contains an error code if an error is detected when the function is being processed.
BLK	OUTPUT	ANY	I, Q, M, D, L	Contains the description of the target field that must be filled. Arrays of the data type STRING are not permitted.

Parameter is a structure

Pay attention to the following when the input parameter consists of a structure: the length of a structure is always aligned with an even number of bytes. This means, that if you should declare a structure with an uneven number of bytes, the structure will require one additional byte in memory.

Example:

The structure is declared as follows:

```
STRUKTUR_7_BYTE: STRUCT
```

```
BYTE_1_2 : WORD
```

```
BYTE_3_4 : WORD
```

```
BYTE_5_6 : WORD
```

```
BYTE_7: BYTE
```

```
END_STRUCT
```

Structure "STRUKTUR_7_BYTE" requires 8bytes of memory.

RET_VAL (Return value)

The return value contains an error code if an error is detected when the function is being processed.

The SFC 21 returns no specific error information.

14.1.18 SFC 22 - CREAT_DB - Create a data block**Description**

The SFC 22 CREAT_DB (create data block) allows the application program to create a data block that does not contain any values. A data block is created that has a number in the specified range and with a specific size. The number assigned to the DB will always be the lowest number in the specified range. To create a DB with specific number you must assigned the same number to the upper and the lower limit of the range. If the application program already contains DBs then the respective numbers cannot be assigned any longer. The length of the DB must be an even number.

Interruptibility

The SFC 22 may be interrupted by OBs with a higher priority. If a call is issued to an SFC 22 from an OB with a higher priority, then the call is rejected with error code 8091h.

Parameters

Parameter	Declaration	Data type	Memory block	Description
LOW_LIMIT	INPUT	WORD	I, Q, M, D, L, constant	The lower limit is the lowest number in the range of numbers that you may assign to your data block.
UP_LIMIT	INPUT	WORD	I, Q, M, D, L, constant	The upper limit is the highest number in the range of numbers that you may assign to your data block.
COUNT	INPUT	WORD	I, Q, M, D, L, constant	The counter defines the number of data bytes that you wish to reserve for your data block. Here you must specify an even number of bytes (maximum 65534).
RET_VAL	OUTPUT	INT	I, Q, M, D, L	The return value contains an error code if an error is detected when the function is being processed.
DB_NUMBER	OUTPUT	WORD	I, Q, M, D, L	The data block number is the number of the data block that was created. When an error occurs (bit 15 of <i>RET_VAL</i> was set) a value of 0 is entered into <i>DB_NUMBER</i>

RET_VAL (Return value) The return value contains an error code if an error is detected when the function is being processed.

Value	Description
0000h	no error
8091h	You issued a nested call to the SFC 22
8092h	The function "Create a DB" cannot be executed at present because <ul style="list-style-type: none"> ■ the function "Compress application memory" is active
80A1h	Error in the number of the DB: <ul style="list-style-type: none"> ■ the number is 0 ■ the number exceeds the CPU-specific number of DBs ■ lower limit > upper limit
80A2h	Error in the length of the DB: <ul style="list-style-type: none"> ■ the length is 0 ■ the length was specified as an uneven number ■ the length is larger than permitted by the CPU
80B1h	No DB-number available
80B2h	Insufficient memory available
80B3h	Insufficient contiguous memory available (compress the memory!)

14.1.19 SFC 23 - DEL_DB - Deleting a data block

Description

The SFC 23 DEL_DB (delete data block) deletes a data block in application memory and if necessary from the load memory of the CPU. The specified DB must not be open on the current level or on a level with a lower priority, i.e. it must not have been entered into one of the two DB-registers and also not into B-stack. Otherwise the CPU will change to STOP mode when the call to the SFC 23 is issued.

The following table indicates when a DB may be deleted by means of the SFC 23.

When the DB ...	then SFC 23 ...
was created by means of a call to SFC 22 "CREAT_DB",	can be used to delete it.
was not created with the key word UNLINKED,	can be used to delete it.

Interruptibility

The SFC 23 may be interrupted by OBs with a higher priority. When another call is issued to the SFC the second call is rejected and *RET_VAL* is set to error code 8091h.

Parameters

Parameter	Declaration	Data type	Memory block	Description
DB_NUMBER	INPUT	WORD	I, Q, M, D, L, constant	Number of the DB that must be deleted.
RET_VAL	OUTPUT	INT	I, Q, M, D, L	The return value contains an error code if an error is detected when the function is being processed.

RET_VAL (Return value)

The return value contains an error code if an error is detected when the function is being processed.

Value	Description
0000h	no error
8091h	The maximum nesting depth of the respective CPU for nested calls to SFC 23 has been exceeded.
8092h	The function "Delete a DB" cannot be executed at present because <ul style="list-style-type: none"> ■ the function "Compress application memory" is active ■ you are copying the DB to be deleted from the CPU to an offline project
80A1h	Error in DB number: <ul style="list-style-type: none"> ■ has a value of 0 ■ exceeds the maximum DB number that is possible on the CPU that is being used
80B1h	A DB with the specified number does not exist on the CPU
80B2h	A DB with the specified number was created with the key word UNLINKED
80B3h	The DB is located on the flash memory card

14.1.20 SFC 24 - TEST_DB - Test data block

Description

The SFC 24 TEST_DB (test data block) returns information about a data block that is located in the application memory of the CPU. The SFC determines the number of data bytes and tests whether the selected DB is write protected.

Parameters

Parameter	Declaration	Data type	Memory block	Description
DB_NUMBER	INPUT	WORD	I, Q, M, D, L, constant	Number of the DB that must be tested.
RET_VAL	OUTPUT	INT	I, Q, M, D, L	The return value contains an error code if an error is detected when the function is being processed.
DB_LENGTH	OUTPUT	WORD	I, Q, M, D, L	The number of data bytes that are contained in the selected DB.
WRITE_PROT	OUTPUT	BOOL	I, Q, M, D, L	Information about the write protection code of the selected DB (1 = write protected).

RET_VAL (Return value)

The return value contains an error code if an error is detected when the function is being processed.

Value	Description
0000h	no error
80A1h	Error in input parameter <i>DB_NUMBER</i> : the selected actual parameter <ul style="list-style-type: none"> ■ has a value of 0 ■ exceeds the maximum DB number that is possible on the CPU that is being used
80B1h	A DB with the specified number does not exist on the CPU.
80B2h	A DB with the specified number was created with the key word UNLINKED.

14.1.21 SFC 25 - COMPRESS - Compressing the User Memory

Gaps in Memory

Gaps can occur in the load memory and in the work memory if data blocks are deleted and reloaded several times. These gaps reduce the effective memory area.

Description

With SFC 25 COMPRESS, you start compression of the RAM section of both the load memory and the work memory. The compression function is the same as when started externally in the RUN mode (mode selector setting).

If compression was started externally and is still active (via Module Status Information), the SFC 25 call will result in an error message.

Parameters

Parameter	Declaration	Data type	Memory block	Description
RET_VAL	OUTPUT	INT	I, Q, M, D, L	Error information
BUSY	OUTPUT	BOOL	I, Q, M, D, L	Indicates whether the compression function started by an SFC 25 call is still active. (1 means active)
DONE	OUTPUT	BOOL	I, Q, M, D, L	Indicates whether the compression function started by SFC 25 was completed successfully. (1 means completed successfully)

Checking the Compression Function

If SFC 25 COMPRESS is called once, the compression function is started.

Call SFC 25 cyclically. First evaluate the parameter *RET_VAL* after every call. Provided that its value is 0, the parameters *BUSY* and *DONE* can be evaluated. If *BUSY* = 1 and *DONE* = 0, this indicates that the compression function is still active. When *BUSY* changes to value 0 and *DONE* to the value 1, this indicates that the compression function was completed successfully.

If SFC 25 is called again afterwards, the compression function is started again.

14.1.22 SFC 28 ... SFC 31 - Time-of-day interrupt**14.1.22.1 Overview****Conditions**

The following conditions must be satisfied before a time-of-day interrupt OB 10 may be called:

- The time-of-day interrupt OB must have been configured by hardware configuration or by means of the SFC 28 (SET_TINT) in the user program.
- The time-of-day interrupt OB must have been activated by hardware configuration or by means of the SFC 30 (ACT_TINT) in the user program.
- The time-of-day interrupt OB must not have been de-selected.
- The time-of-day interrupt OB must exist in the CPU.
- When the SFC 30 is used to set the time-of-day interrupt by a single call to the function the respective start date and time must not have expired when the function is initiated; the periodic execution initiates the time-of-day interrupt OB when the specified period has expired (start time + multiple of the period).

SFCs 28 ... 31

The system function are used as follows:

- Set: SFC 28
- Cancel: SFC 29
- Activate: SFC 30
- Query: SFC 31

14.1.22.2 SFC 28 - SET_TINT - Set time-of-day interrupt

The SFC 28 SET_TINT (set time-of-day interrupt) defines the start date and time for the time-of-day interrupt - organization modules. The start time ignores any seconds and milliseconds that may have been specified, these are set to 0.

Parameters

Parameter	Declaration	Data type	Memory block	Description
OB_NR	INPUT	INT	I, Q, M, D, L, constant	Number of the OB, that is started at a time <i>SDT</i> + multiple of <i>PERIOD</i> (OB10, OB11).
SDT	INPUT	DT	D, L	Start date and start time
PERIOD	INPUT	WORD	I, Q, M, D, L, constant	Period from the start of <i>SDT</i> : 0000h = single 0201h = at minute intervals 0401h = hourly 1001h = daily 1201h = weekly 1401h = monthly 1801h = annually 2001h = at the end of a month
RET_VAL	OUTPUT	INT	I, Q, M, D, L	The return value contains an error code if an error is detected when the function is being processed.

RET_VAL (Return value) The return value contains an error code if an error is detected when the function is being processed.

Value	Description
0000h	No error has occurred.
8090h	<i>OB_NR</i> parameter error
8091h	<i>SDT</i> parameter error
8092h	<i>PERIOD</i> parameter error
80A1h	The stated date/time has already expired.

14.1.22.3 SFC 29 - CAN_TINT - Cancel time-of-day interrupt

The SFC 29 CAN_TINT (cancel time-of-day interrupt) deletes the start date and time of the specified time-of-day interrupt - organization block.

Parameters

Parameter	Declaration	Data type	Memory block	Description
OB_NR	INPUT	INT	I, Q, M, D, L, constant	Number of the OB, in which the start date and time will be canceled (OB 10, OB 11).
RET_VAL	OUTPUT	INT	I, Q, M, D, L	The return value contains an error code if an error is detected when the function is being processed.

RET_VAL (Return value)

Value	Description
0000h	No error has occurred.
8090h	<i>OB_NR</i> parameter error
80A0h	No start date/time was defined for the respective time-of-day interrupt OB.

14.1.22.4 SFC 30 - ACT_TINT - Activate time-of-day interrupt

The SFC 30 ACT_TINT (activate time-of-day interrupt) is used to activate the specified time-of-day interrupt - organization block.

Parameters

Parameter	Declaration	Data type	Memory block	Description
OB_NR	INPUT	INT	I, Q, M, D, L, constant	Number of the OB to be activated (OB 10, OB 11)
RET_VAL	OUTPUT	INT	I, Q, M, D, L	The return value contains an error code if an error is detected when the function is being processed.

RET_VAL (Rückgabewert)

Value	Description
0000h	No error has occurred.
8090h	<i>OB_NR</i> parameter error
80A0h	No start date/time was defined for the respective time-of-day interrupt OB
80A1h	The activated time has expired; this error can only occur when the function is executed once only.

14.1.22.5 SFC 31 - QRY_TINT - Query time-of-day interrupt

The SFC 31 QRY_TINT (query time-of-day interrupt) can be used to make the status of the specified time-of-day interrupt - organization block available via the output parameter *STATUS*.

Parameters

Parameter	Declaration	Data type	Memory block	Description
OB_NR	INPUT	INT	I, Q, M, D, L, constant	Number of the OB, whose status will be queried (OB 10, OB 11).
RET_VAL	OUTPUT	INT	I, Q, M, D, L	The return value contains an error code if an error is detected when the function is being processed.
STATUS	OUTPUT	WORD	I, Q, M, D, L	Status of the time-of-day interrupt.

RET_VAL (Return value)

Value	Description
0000h	No error has occurred.
8090h	<i>OB_NR</i> parameter error

STATUS

Bit	Value	Description
0	0	The operating system has enabled the time-of-day interrupt.
1	0	New time-of-day interrupts are not discarded.
2	0	Time-of-day interrupt has not been activated and has not expired.
3	-	reserved
4	0	Time-of-day interrupt-OB has not been loaded.
5	0	An active test function disables execution of the time-of-day interrupt-OB.

14.1.23 SFC 32 - SRT_DINT - Start time-delay interrupt**Description**

The SFC 32 SRT_DINT (start time-delay interrupt) can be used to start a time-delay interrupt that issues a call to a time-delay interrupt OB after the pre-configured delay time (parameter *DTIME*) has expired.

Parameter *SIGN* specifies a user-defined code that identifies the start of the time-delay interrupt. While the function is being executed the values of *DTIME* and *SIGN* appear in the startup event information of the specified OB.

Conditions

The following conditions must be satisfied before a time-delay interrupt OB may be called:

- the time-delay interrupt OB must have been started (using the SFC 32)
- the time-delay interrupt OB must not have been de-selected.
- the time-delay interrupt OB must exist in the CPU.

Parameters

Parameter	Declaration	Data type	Memory block	Description
OB_NR	INPUT	INT	I, Q, M, D, L, constant	Number of the OB, that is started after the time delay (OB 20, OB 21).
DTIME	INPUT	TIME	I, Q, M, D, L, constant	The delay time (1 ... 60 000ms).
SIGN	INPUT	WORD	I, Q, M, D, L, constant	Code that is inserted into the startup event information of the OB when a call is issued to the time-delay interrupt.
RET_VAL	OUTPUT	INT	I, Q, M, D, L	The return value contains an error code if an error is detected when the function is being processed.

Accuracy The time from the call to the SFC 32 and the start of the time-delay interrupt OB may be less than the configured time by no more than one millisecond, provided that no interrupt events have occurred that delay the call.

RET_VAL (Return value)

Value	Description
0000h	No error has occurred
8090h	OB_NR parameter error
8091h	DTIME parameter error

14.1.24 SFC 33 - CAN_DINT - Cancel time-delay interrupt

Description The SFC 33 CAN_DINT (cancel time-delay interrupt) cancels a time-delay interrupt that has already been started. The call to the respective time-delay interrupt OB will not be issued.

Conditions The following conditions must be satisfied before a time-delay interrupt OB may be called:

- The time-delay interrupt OB must have been started (using the SFC 32).
- The time-delay interrupt OB must not have been de-selected.
- The time-delay interrupt OB must exist in the CPU.

Parameters

Parameter	Declaration	Data type	Memory block	Description
OB_NR	INPUT	INT	I, Q, M, D, L, constant	Number of the OB, that must be cancelled (OB 20, OB 21).
RET_VAL	OUTPUT	INT	I, Q, M, D, L	The return value contains an error code if an error is detected when the function is being processed.

RET_VAL (Return value)

Value	Description
0000h	No error has occurred.
8090h	OB_NR parameter error
80A0h	Time-delay interrupt has not been started.

14.1.25 SFC 34 - QRY_DINT - Query time-delay interrupt

Description The SFC 34 QRY_DINT (query time-delay interrupt) can be used to make the status of the specified time-delay interrupt available via the output parameter *STATUS*.

Conditions

The following conditions must be satisfied before a time-delay interrupt OB may be called:

- The time-delay interrupt OB must have been started (using the SFC 32).
- The time-delay interrupt OB must not have been de-selected.
- The time-delay interrupt OB must exist in the CPU.

Parameters

Parameter	Declaration	Data type	Memory block	Description
OB_NR	INPUT	INT	I, Q, M, D, L, constant	Number of the OB, that must be cancelled (OB 20, OB 21).
RET_VAL	OUTPUT	INT	I, Q, M, D, L	The return value contains an error code if an error is detected when the function is being processed.
STATUS	OUTPUT	WORD	I, Q, M, D, L	Status of the time-delay interrupt.

RET_VAL (Return value)

Value	Description
0000h	No error has occurred.
8090h	OB_NR parameter error

STATUS

Bit	Value	Description
0	0	The operating system has enabled the time-delay interrupt.
1	0	New time-delay interrupts are not discarded.
2	0	Time-delay interrupt has not been activated and has not expired.
3	-	-
4	0	Time-delay interrupt-OB has not been loaded.
5	0	An active test function disables execution of the time-delay interrupt-OB.

14.1.26 SFC 36 - MSK_FLT - Mask synchronous errors**Description**

The SFC 36 MSK_FLT (mask synchronous faults) is used to control the reaction of the CPU to synchronous faults by masking the respective synchronous faults.

The call to the SFC 36 masks the synchronous faults of the current priority class. If you set individual bits of the synchronous fault mask in the input parameters to "1" other bits that have previously been set will remain at "1". This result in new synchronous fault masks that can be retrieved via the output parameters. Masked synchronous faults are entered into an error register and do not issue a call to an OB. The error register is read by means of the SFC 38 READ_ERR.

Parameters

Parameter	Declaration	Data type	Memory block	Description
PRGFLT_SET_MASK	INPUT	DWORD	I, Q, M, D, L, constant	Programming faults that must be masked out
ACCFLT_SET_MASK	INPUT	DWORD	I, Q, M, D, L, constant	Access faults that must be masked out
RET_VAL	OUTPUT	INT	I, Q, M, D, L	The return value contains an error code if an error is detected when the function is being processed.
PRGFLT_MASKED	OUTPUT	DWORD	I, Q, M, D, L	Masked programming faults
ACCFLT_MASKED	OUTPUT	DWORD	I, Q, M, D, L	Masked access errors

RET_VAL (Return value)

Value	Description
0000h	None of the faults has previously been masked.
0001h	One or more of the faults has already been masked, however, the other faults will still be masked out.

14.1.27 SFC 37 - DMSK_FLT - Unmask synchronous errors**Description**

The SFC 37 DMSK_FLT (unmask synchronous faults) unmask any masked synchronous faults. A call to the SFC 37 unmask the synchronous faults of the current priority class. The respective bits in the fault mask of the input parameters are set to "1". This results in new fault masks that you can read via the output parameters. Queried entries are deleted from in the error register.

Parameters

Parameter	Declaration	Data type	Memory block	Description
PRGFLT_RESET_MASK	INPUT	DWORD	I, Q, M, D, L, constant	Programming faults that must be unmasked
ACCFLT_RESET_MASK	INPUT	DWORD	I, Q, M, D, L, constant	Access faults that must be unmasked
RET_VAL	OUTPUT	INT	I, Q, M, D, L	The return value contains an error code if an error is detected when the function is being processed.
PRGFLT_MASKED	OUTPUT	DWORD	I, Q, M, D, L	Masked programming faults
ACCFLT_MASKED	OUTPUT	DWORD	I, Q, M, D, L	Masked access errors

RET_VAL (Return value)

Value	Description
0000h	All the specified faults have been unmasked.
0001h	One or more of the faults was not masked, however, the other faults will still be unmasked.

14.1.28 SFC 38 - READ_ERR - Read error register**Description**

The SFC 38 READ_ERR (read error registers) reads the contents of the error register. The structure of the error register is identical to the structure of the programming fault and access fault masks that were defined as input parameters by means of the SFC 36 and 37. When you issue a call to the SFC 38 the specified entries are read and simultaneously deleted from the error register. The input parameters define which synchronous faults will be queried in the error register. The function indicates the masked synchronous faults of the current priority class that have occurred once or more than once. When a bit is set it signifies that the respective masked synchronous fault has occurred.

Parameters

Parameter	Declaration	Data type	Memory block	Description
PRGFLT_QUERY	INPUT	DWORD	I, Q, M, D, L, constant	Query programming faults
ACCFLT_QUERY	INPUT	DWORD	I, Q, M, D, L, constant	Query access faults
RET_VAL	OUTPUT	INT	I, Q, M, D, L	The return value contains an error code if an error is detected when the function is being processed.
PRGFLT_ESR	OUTPUT	DWORD	I, Q, M, D, L	Programming faults that have occurred
ACCFLT_ESR	OUTPUT	DWORD	I, Q, M, D, L	Access faults that have occurred

RET_VAL (Return value)

Value	Description
0000h	All the specified faults have been masked.
0001h	One or more of the faults that have occurred was not masked.

14.1.29 SFC 39 - DIS_IRT - Disabling interrupts**Description**

With the SFC 39 DIS_IRT (disable interrupt) you disable the processing of new interrupts and asynchronous errors. This means that if an interrupt occurs, the operating system of the CPU reacts as follows:

- if neither calls an interrupt OB asynchronous error OB,
- nor triggers the normal reaction if an interrupt OB or asynchronous error OB is not programmed.

If you disable interrupts and asynchronous errors, this remains in effect for all priority classes. The effects of SFC 39 can only be canceled again by calling the SFC 40 or by a restart.

Whether the operating system writes interrupts and asynchronous errors to the diagnostic buffer when they occur depends on the input parameter setting you select for *MODE*.



Remember that when you program the use of the SFC 39, all interrupts that occur are lost.

Parameters

Parameter	Declaration	Data type	Memory block	Description
MODE	INPUT	BYTE	I, Q, M, D, L, constant	Specifies which interrupts and asynchronous errors are disabled.
OB_NR	INPUT	INT	I, Q, M, D, L, constant	OB number
RET_VAL	OUTPUT	INT	I, Q, M, D, L	If an error occurs while the function is active, the return value contains an error code.

MODE

MODE	Description
00	All newly occurring interrupts and asynchronous errors are disabled (Synchronous errors are not disabled).
01	All newly occurring events belonging to a specified interrupt class are disabled. Identify the interrupt class by specifying it as follows: <ul style="list-style-type: none"> ■ Time-of-day interrupts: 10 ■ Time-delay interrupts: 20 ■ Cyclic interrupts: 30 ■ Hardware interrupts: 40 ■ Interrupts for DP-V1: 50 ■ Asynchronous error interrupts: 80 Entries into the diagnostic buffer are continued.
02	All new occurrences of a specified interrupt are disabled. You specify the interrupt using the OB number. Entries into the diagnostic buffer are continued.
80	All new occurrences of a specified interrupt are disabled. You specify the interrupt using the OB number. Entries continue to be made in the diagnostic buffer.
81	All new occurrences belonging to a specified interrupt class are disabled and are no longer entered in the diagnostic buffer. The operating system enters event 5380h in the diagnostic buffer.
82	All new occurrences belonging to a specified interrupt are disabled and are no longer entered in the diagnostic buffer. The operating system enters event 5380h in the diagnostic buffer.

RET_VAL (Return value)

Value	Description
0000h	No error occurred.
8090h	The input parameter <i>OB_NR</i> contains an illegal value.
8091h	The input parameter <i>MODE</i> contains an illegal value.
8xyyh	General error information ↪ Chap. 4.2 'General and Specific Error Information RET_VAL' page 66

14.1.30 SFC 40 - EN_IRT - Enabling interrupts**Description**

With the SFC 40 EN_IRT (enable interrupt) you enable the processing of new interrupts and asynchronous errors that you previously disabled with the SFC 39. This means that if an interrupt event occurs, the operating system of the CPU reacts in one of the follows ways:

- it calls an interrupt OB or asynchronous error OB,
or
- it triggers the standard reaction if an interrupt OB or asynchronous error OB is not programmed.

Parameters

Parameter	Declaration	Data type	Memory block	Description
MODE	INPUT	BYTE	I, Q, M, D, L, constant	Specifies which interrupts and asynchronous errors will be enabled.
OB_NR	INPUT	INT	I, Q, M, D, L, constant	OB number
RET_VAL	OUTPUT	INT	I, Q, M, D, L	If an error occurs while the function is active, the return value contains an error code.

MODE

MODE	Description
00	All newly occurring interrupts and asynchronous errors are enabled.
01	All newly occurring events belonging to a specified interrupt class are enabled. Identify the interrupt class by specifying it as follows: <ul style="list-style-type: none"> ■ Time-of-day interrupts: 10 ■ Time-delay interrupts: 20 ■ Cyclic interrupts: 30 ■ Hardware interrupts: 40 ■ Interrupts for DP-V1: 50 ■ Asynchronous error interrupts: 80
02	All newly occurring events of a specified interrupt are enabled. You specify the interrupt using the OB number.

RET_VAL (Return value)

Value	Description
0000h	No error occurred.
8090h	The input parameter <i>OB_NR</i> contains an illegal value.
8091h	The input parameter <i>MODE</i> contains an illegal value.
8xyyh	General error information ↪ Chap. 4.2 'General and Specific Error Information RET_VAL' page 66

14.1.31 SFC 41 - DIS_AIRT - Delaying interrupts**Description**

The SFC 41 DIS_AIRT (disable alarm interrupts) disables processing of interrupt OBs and asynchronous fault OBs with a priority that is higher than the priority of the current OB. You can issue multiple calls to the SFC 41. The operating system will count the number of calls to the SFC 41. Processing of interrupt OBs is disabled until you issue an SFC 42 EN_AIRT to enable all interrupt OBs and asynchronous fault OBs that were disabled by means of SFC 41 or until processing of the current OB has been completed.

Any queued interrupt or asynchronous fault interrupts will be processed as soon as you enable processing by means of the SFC 42 EN_AIRT or when processing of the current OB has been completed.

Parameters

Parameter	Declaration	Data type	Memory area	Description
RET_VAL	OUTPUT	INT	I, Q, M, D, L	Number of disable calls (= number of calls to the SFC 41)

RET_VAL (Return value)

When the SFC has been completed the return value *RET_VAL* indicates the number of disables, i.e. the number of calls to the SFC 41 (processing of all alarm interrupts is only enabled again when *RET_VAL* = 0).

14.1.32 SFC 42 - EN_AIRT - Enabling delayed interrupts**Description**

The SFC 42 EN_AIRT (enable alarm interrupts) enables processing of high priority interrupt OBs and asynchronous fault OBs.

Every disabled interrupt must be re-enabled by means of the SFC 42. If you have disabled 5 different interrupts by means of 5 SFC 41 calls you must re-enable every alarm interrupt by issuing 5 individual SFC 42 calls.

Parameters

Parameter	Declaration	Data type	Memory block	Description
RET_VAL	OUTPUT	INT	I, Q, M, D, L	Number of disabled interrupts when the SFC 42 has been completed or the error code when an error has occurred while the function was being processed.

RET_VAL (Return value) When the SFC has been completed the return value *RET_VAL* indicates the number of disables, i.e. the number of calls to the SFC 41 (processing of all alarm interrupts is only enabled again when *RET_VAL* = 0).

Value	Description
8080h	The function was started in spite of the fact that the alarm interrupt had already been enabled.

14.1.33 SFC 43 - RE_TRIGR - Retrigger the watchdog

Description The SFC 43 RE_TRIGR (retrigger watchdog) restarts the watchdog timer of the CPU.

Parameter and return values The SFC 43 has neither parameters nor return values.

14.1.34 SFC 44 - REPL_VAL - Replace value to ACCU1

Description The SFC 44 REPL_VAL (replace value) transfers a value into ACCU1 of the program level that cause the fault. A call to the SFC 44 can only be issued from synchronous fault OBs (OB 121, OB 122).

Application example for the SFC 44:

When an input module malfunctions so that it is not possible to read any values from the respective module then OB 122 will be started after each attempt to access the module. The SFC 44 REPL_VAL can be used in OB 122 to transfer a suitable replacement value into ACCU1 of the program level that was interrupted. The program will be continued with this replacement value. The information required to select a replacement value (e.g. the module where the failure occurred, the respective address) are available from the local variables of OB 122.

Parameters

Parameter	Declaration	Data type	Memory block	Description
VAL	INPUT	DWORD	I, Q, M, D, L, constant	Replacement value
RET_VAL	OUTPUT	INT	I, Q, M, D, L	The return value contains an error code if an error is detected when the function is being processed.

RET_VAL (Return value)

Value	Description
0000h	No error has occurred. A replacement value has been entered.
8080h	The call to the SFC 44 was not issued from a synchronous fault OB (OB 121, OB 122).

14.1.35 SFC 46 - STP - STOP the CPU

Description The SFC 46 STP changes the operation mode of the CPU to STOP.

Parameter and return values The SFC 46 has neither parameters nor return values.

14.1.36 SFC 47 - WAIT - Delay the application program

Description The SFC 47 WAIT can be used to program time delays or wait times from 1 up to 32767 μ s in your application program.

Interruptibility The SFC 47 may be interrupted by high priority OBs.



Delay times that were programmed by means of the SFC 47 are minimum times that may be extended by the execution time of the nested priority classes as well as the load on the system!

Parameters

Parameter	Declaration	Data type	Memory block	Description
WT	INPUT	INT	I, Q, M, D, L, constant	Parameter <i>WT</i> contains the delay time in μ s.

Error information The SFC 47 does not return specific error codes.

14.1.37 SFC 49 - LGC_GADR - Read the slot address

Description The SFC 49 LGC_GADR (convert logical address to geographical address) determines the slot location for a module from the logical address as well as the offset in the user-data address space for the module.

Parameters

Parameter	Declaration	Data type	Memory block	Description
IOID	INPUT	BYTE	I, Q, M, D, L, constant	Identifier for the address space: 54h = peripheral input (PI) 55h = peripheral output (PQ) For hybrid modules the SFC returns the area identifier of the lower address. When the addresses are equal the SFC returns identifier 54h.
LADDR	INPUT	WORD	I, Q, M, D, L, constant	Logical address. For hybrid modules the lower of the two addresses must be specified.
RET_VAL	OUTPUT	INT	I, Q, M, D, L	The return value contains an error code if an error is detected when the function is being processed.
AREA	OUTPUT	BYTE	I, Q, M, D, L	Area identifier: this defines how the remaining output parameters must be interpreted.

Parameter	Declaration	Data type	Memory block	Description
RACK	OUTPUT	WORD	I, Q, M, D, L	See <i>AREA</i> below
SLOT	OUTPUT	WORD	I, Q, M, D, L	
SUBADDR	OUTPUT	WORD	I, Q, M, D, L	

AREA *AREA* specifies how the output parameters *RACK*, *SLOT* and *SUBADDR* must be interpreted. These dependencies are depicted below.

Value of <i>AREA</i>	System	Significance of <i>RACK</i> , <i>SLOT</i> and <i>SUBADDR</i>
0	-	reserved
1	Siemens S7-300	<i>RACK</i> : Rack number <i>SLOT</i> : Slot number <i>SUBADDR</i> : Address offset to base address
2	Decentralized periphery	<i>RACK</i> (Low Byte): Station number <i>RACK</i> (High Byte): DP master system ID <i>SLOT</i> : Slot number at station <i>SUBADDR</i> : Address offset to base address
3 ... 6	-	reserved

RET_VAL (Return value) The return value contains an error code if an error is detected when the function is being processed.

Value	Description
0000h	No error has occurred.
8090h	The specified logical address is not valid or an illegal value exists for parameter <i>IOID</i> .

14.1.38 SFC 50 - RD_LGADR - Read all logical addresses of a module

Description The SFC 50 RD_LGADR (read module logical addresses) determines all the stipulated logical addresses of a module starting with a logical address of the respective module. You must have previously configured the relationship between the logical addresses and the modules. The logical addresses that were determined are entered in ascending order into the field *PEADDR* or into field *PAADDR*.

Parameters

Parameter	Declaration	Data type	Memory block	Description
IOID	INPUT	BYTE	I, Q, M, D, L, constant	Area identification: 54h = peripheral input (PI) 55h = peripheral output (PQ)
LADDR	INPUT	WORD	I, Q, M, D, L, constant	A logical address
RET_VAL	OUTPUT	INT	I, Q, M, D, L	The return value contains an error code if an error is detected when the function is being processed.
PEADDR	OUTPUT	ANY	I, Q, M, D, L	Field for the PI-addresses, field elements must be of data type WORD.
PECOUNT	OUTPUT	INT	I, Q, M, D, L	Number of returned PI addresses
PAADDR	OUTPUT	ANY	I, Q, M, D, L	Field for PQ addresses, field elements must be of data type WORD.
PACOUNT	OUTPUT	INT	I, Q, M, D, L	Number of returned PQ addresses

RET_VAL (Return value) The return value contains an error code if an error is detected when the function is being processed.

Value	Description
0000h	No error has occurred.
8090h	The specified logical address is not valid or illegal value for parameter <i>IOID</i> .
80A0h	Error in output parameter <i>PEADDR</i> : data type of the field elements is not WORD.
80A1h	Error in output parameter <i>PAADDR</i> : data type of the field elements is not WORD.
80A2h	Error in output parameter <i>PEADDR</i> : the specified field could not accommodate all the logical addresses.
80A3h	Error in output parameter <i>PAADDR</i> : the specified field could not accommodate all the logical addresses.

14.1.39 SFC 51 - RDSYSST - Read system status list SSL**Description**

With the SFC 51 RDSYSST (read system status) a partial list respectively an extract of a partial list of the SSL (**s**ystem **s**tatus **l**ist) may be requested. Here with the parameters *SSL_ID* and *INDEX* the objects to be read are defined.

The *INDEX* is not always necessary. It is used to define an object within a partial list.

By setting *REQ* the query is started. As soon as *BUSY* = 0 is reported, the data are located in the target area *DR*.

Information about the SSL may be found in Chapter "System status list SSL".

Parameters

Parameter	Declaration	Data type	Memory block	Description
REQ	INPUT	BOOL	I, Q, M, D, L, constant	REQ = 1: start processing
SSL_ID	INPUT	WORD	I, Q, M, D, L, constant	SSL_ID of the partial list or the partial list extract
INDEX	INPUT	WORD	I, Q, M, D, L, constant	Type or number of an object in a partial list
RET_VAL	OUTPUT	INT	I, Q, M, D, L	The return value contains an error code if an error is detected when the function is being processed
BUSY	OUTPUT	BOOL	I, Q, M, D, L	BUSY = 1: read operation has not been completed
SSL_HEADER	OUTPUT	STRUCT	D, L	WORD structure with 2 types: LENGTHDR: length record set N_DR: number of existing related records (for access to partial list header information) or number of records transmitted in DR.
DR	OUTPUT	ANY	I, Q, M, D, L	Target area for the SSL partial list or the extraction of the partial list that was read: If you have only read the SSL partial list header info of a SSL partial list, you may not evaluate DR, but only SSL_HEADER. Otherwise the product of LENGTHDR and N_DR shows the number of bytes stored in DR.

RET_VAL (Return value) The return value contains an error code if an error is detected when the function is being processed.

Value	Description
0000h	no error
0081h	The length of the result field is too low. The function still returns as many records as possible. The SSL header indicates the returned number of records.
7000h	First call with REQ = 0: data transfer not active; BUSY = 0.
7001h	First call with REQ = 1: data transfer initiated; BUSY = 1.
7002h	Intermediate call (REQ irrelevant): data transfer active; BUSY = 1.
8081h	The length of the result field is too low. There is not enough space for one record.
8082h	SSL_ID is wrong or unknown to the CPU or the SFC.
8083h	Bad or illegal INDEX.
8085h	Information is not available for system-related reasons, e.g. because of a lack of resources.
8086h	Record set may not be read due to a system error.

Value	Description
8087h	Record set may not be read because the module does not exist or it does not return an acknowledgment.
8088h	Record set may not be read because the current type identifier differs from the expected type identifier.
8089h	Record set may not be read because the module does not support diagnostic functions.
80A2h	DP protocol error - Layer-2 error (temporary fault).
80A3h	DP protocol error on user-interface/user (temporary fault).
80A4h	Bus communication failure. This error occurs between the CPU and the external DP interface (temporary fault).
80C5h	Decentralized periphery not available (temporary fault).

14.1.40 SFC 52 - WR_USMSG - Write user entry into diagnostic buffer

Description The SFC 52 WR_USMSG (write user element in diagnosis buffer) writes a used defined diagnostic element into the diagnostic buffer.

Send diagnostic message To determine whether it is possible to send user defined diagnostic messages you must issue a call to SFC 51 "RDSYSST" with parameters *SSL_ID* = 0132h and *INDEX* = 0005h. Sending of user defined diagnostic messages is possible if the fourth word of the returned record set is set to "1". If it should contain a value of "0", sending is not possible.

Send buffer full The diagnostic message can only be entered into the send buffer if this is not full. At a maximum of 50 entries can be stored in the send buffer.

If the send buffer is full

- the diagnostic event is still entered into the diagnostic buffer
- the respective error message (8092h) is entered into parameter *RET_VAL*.

Partner not registered The diagnostic message can only be entered into the send buffer if this is not full. At a maximum of 50 entries can be stored in the send buffer. If the send buffer is full

- the diagnostic event is still entered into the diagnostic buffer,
- the respective error message (0091h or 8091h) is entered into parameter *RET_VAL*.

The contents of an entry The structure of the entry in the diagnostic buffer is as follows:

Byte	Contents
1, 2	Event ID
3	Priority class
4	OB number
5, 6	reserved
7, 8	Additional information 1
9, 10, 11, 12	Additional information 2
13 ... 20	Time stamp: The data type of the time stamp is Date_and_Time.

Event ID Every event is assigned to an event ID.

Additional information The additional information contains more specific information about the event. This information differs for each event. When a diagnostic event is generated the contents of these entries may be defined by the user.

When a user defined diagnostic message is sent to the partners this additional information may be integrated into the (event-ID specific) message text as an associated value.

Parameters

Parameter	Declaration	Data type	Memory block	Description
SEND	INPUT	BOOL	I, Q, M, D, L, constant	Enable sending of user defined diagnostic messages to all registered partners.
EVENTN	INPUT	WORD	I, Q, M, D, L, constant	Event-ID. The user assigns the event-ID. This is not preset by the message server.
INFO1	INPUT	ANY	I, Q, M, D, L	Additional information, length 1 word
INFO2	INPUT	ANY	I, Q, M, D, L	Additional information, length 2 words
RET_VAL	OUTPUT	INT	I, Q, M, D, L	The return value contains an error code if an error is detected when the function is being processed.

SEND When *SEND* is set to 1 the user defined diagnostic message is sent to all partners that have registered for this purpose. Sending is only initiated when one or more partners have registered and the send buffer is not full. Messages are sent asynchronously with respect to the application program.

EVENTN The event ID of the user event is entered into *EVENTN*. Event IDs must be of the format 8xyzh , 9xyzh, Axyzh and Bxyzh. Here the IDs of format 8xyzh and 9xyzh refer to pre-defined events and IDs of format Axyzh and Bxyzh refer to user-defined events.

An event being activated is indicated by x = 1,
an event being deactivated by x = 0.

For events of the class A and B, yz refers to the message number that was predefined in hexadecimal representation when the messages were configured.

INFO1 *INFO1* contains information with a length of one word. The following data types are valid:

- WORD
- INT
- ARRAY [0...1] OF CHAR

INFO1 can be integrated as associated value into the message text, i.e. to add current information to the message.

INFO2 *INFO2* contains information with a length of two words. The following data types are valid:

- DWORD
- DINT
- REAL
- TIME
- ARRAY [0...3] OF CHAR

INFO2 can be integrated as associated value into the message text, i.e. to add current information to the message.

RET_VAL (Return value) The return value contains an error code if an error is detected when the function is being processed.

Value	Description
0000h	no error
0091h	No partner registered (the diagnostic event has been entered into the diagnostic buffer)
8083h	Data type <i>INFO1</i> not valid
8084h	Data type <i>INFO2</i> not valid
8085h	<i>EVENTN</i> not valid
8086h	Length of <i>INFO1</i> not valid
8087h	Length of <i>INFO2</i> not valid
8091h	Error message identical to error code 0091h
8092h	Send operation currently not possible, send buffer full (the diagnostic event has been entered into the diagnostic buffer)

14.1.41 FC/SFC 53 - uS_Tick - Time measurement

This block allows you to read the μ s ticker integrated in the SPEED7-CPU. The μ s ticker is a 32bit μ s time counter that starts at every reboot with 0 and counts to $2^{32}-1\mu$ s. At overflow the counter starts again with 0. With the help of the difference creation of the *RETVAL* results of 2 FC/SFC 53 calls before and after an application you may thus evaluate the runtime of the application in μ s.

Runtime in dependence of the operating mode

Status	µs system time
Start-up	Starts with 0 and is permanently updated
RUN	is permanently updated
STOP	is stopped (time cannot be read)
Reboot	Starts again with 0

Parameters

Name	Declaration	Type	Comment
RETVAL	OUT	DINT	System time in µs

RETVAL

The parameter *RETVAL* contains the read system time in the range of 0 ... 2³²-1µs.



Please note for further calculations that the system time is returned in a signed data type.

14.1.42 SFC 54 - RD_DPARM - Read predefined parameter

Description

The SFC 54 RD_DPARM (read defined parameter) reads the record with number *RECNUM* of the selected module from the respective SDB1xy.

Parameter *RECORD* defines the target area where the record will be saved

Parameters

Parameter	Declaration	Data type	Memory block	Description
IOID	INPUT	BYTE	I, Q, M, D, L, constant	Identifier for the address space: 54h = peripheral input (PI) 55h = peripheral output (PQ) For hybrid modules the SFC returns the area identifier of the lower address. When the addresses are equal the SFC returns identifier 54h.
LADDR	INPUT	WORD	I, Q, M, D, L, constant	Logical address. For hybrid modules the lower of the two addresses must be specified.
RECNUM	INPUT	BYTE	I, Q, M, D, L, constant	record number (valid range: 0 ... 240)

Parameter	Declaration	Data type	Memory block	Description
RET_VAL	OUTPUT	INT	I, Q, M, D, L	The return value contains an error code if an error is detected when the function is being processed. Additionally: the length of the record that was read in bytes, provided the size of the record fits into the target area and that no communication errors have occurred.
RECORD	OUTPUT	ANY	I, Q, M, D, L	Target area for the record that was read. Only data type BYTE is valid.

RET_VAL (Return value)

Two distinct cases exist for *RET_VAL* = 8xxxh:

- Temporary error (error codes 80A2h ... 80A4h, 80Cxh):
For this type of error it is possible that the error corrects itself without intervention. For this reason it is recommended that you re-issue the call to the SFC (once or more than once). Example for temporary errors: the required resources are occupied at present (80C3h).
Example for temporary errors: the required resources are occupied at present (80C3h).
- Permanent error (error codes 809xh, 80A1h, 80Bxh, 80Dxh):
These errors cannot be corrected without intervention. A repeat of the call to the SFC is only meaningful when the error has been removed.
Example for permanent errors: incorrect length of the record that must be transferred (80B1h).

Value	Description
7000h	First call with <i>REQ</i> = 0: data transfer not active; <i>BUSY</i> is set to 0.
7001h	First call with <i>REQ</i> = 1: data transfer initiated; <i>BUSY</i> is set to 1.
7002h	Intermediate call (<i>REQ</i> irrelevant): data transfer active; <i>BUSY</i> is set to 1.
8090h	The specified logical base address is invalid: no assignment available in SDB1/SDB2x, or this is not a base address.
8092h	ANY-reference contains a type definition that is not equal to BYTE.
8093h	This SFC is not valid for the module selected by <i>LADDR</i> and <i>IOID</i> .
80B1h	The length of the target area defined by <i>RECORD</i> is too small.
80D0h	The respective SDB does not contain an entry for the module.
80D1h	The record number has not been configured in the respective SDB for the module.
80D2h	According to the type identifier the module cannot be configured.
80D3h	SDB cannot be accessed since it does not exist.
80D4h	Bad SDB structure: the SDB internal pointer points to an element outside of the SDB.

14.1.43 SFC 55 - WR_PARM - Write dynamic parameter

Description

The SFC 55 WR_PARM (write parameter) transfers the record *RECORD* to the target module. Any parameters for this module that exist in the respective SDB will not be replaced by the parameters that are being transferred to the module.

These SFC can be used for digital-, analog modules, FMs, CPs and via PROFIBUS DP-V1.

Conditions

It is important that the record that must be transferred is not static, i.e.:

- do not use record 0 since this record is static for the entire system.
- if the record appears in SDBs 100 ... 129 then the static-bit must not be set.

Parameters

Parameter	Declaration	Data type	Memory block	Description
REQ	INPUT	BOOL	I, Q, M, D, L, constant	REQ = 1: write request
IOID	INPUT	BYTE	I, Q, M, D, L, constant	Identifier for the address space: 54h = peripheral input (PI) 55h = peripheral output (PQ) For hybrid modules the SFC returns the area identifier of the lower address. When the addresses are equal the SFC returns identifier 54h.
LADDR	INPUT	WORD	I, Q, M, D, L, constant	Logical base address of the module. For hybrid modules the lower of the two addresses must be specified.
RECNUM	INPUT	BYTE	I, Q, M, D, L, constant	Record number (valid values: 0 ... 240)
RECORD	INPUT	ANY	I, Q, M, D, L	Record
RET_VAL	OUTPUT	INT	I, Q, M, D, L	The return value contains an error code if an error is detected when the function is being processed.
BUSY	OUTPUT	BOOL	I, Q, M, D, L	BUSY = 1: the write operation has not been completed.

RECORD

With the first call to the SFC the data that must be transferred is read from the parameter *RECORD*. However, if the transfer of the record should require more than one call duration, the contents of the parameter *RECORD* is no longer valid for subsequent calls to the SFC (of the same job).

RET_VAL (Return value)

Two distinct cases exist for RET_VAL = 8xxxh:

- Temporary error (error codes 80A2h ... 80A4h, 80Cxh):
For this type of error it is possible that the error corrects itself without intervention. For this reason it is recommended that you re-issue the call to the SFC (once or more than once).
Example for temporary errors: the required resources are occupied at present (80C3h).
- Permanent error (error codes 809xh, 80A1h, 80Bxh, 80Dxh):
These errors cannot be corrected without intervention. A repeat of the call to the SFC is only meaningful when the error has been removed.
Example for permanent errors: incorrect length of the record that must be transferred (80B1h).

Value	Description
7000h	First call with <i>REQ</i> = 0: data transfer not active; <i>BUSY</i> is set to 0.
7001h	First call with <i>REQ</i> = 1: data transfer initiated; <i>BUSY</i> is set to 1.
7002h	Intermediate call (<i>REQ</i> irrelevant): data transfer active; <i>BUSY</i> is set to 1.
8090h	The specified logical base address is invalid: no assignment available in SDB1/SDB2x, or this is not a base address.
8092h	ANY-reference contains a type definition that is not equal to BYTE.
8093h	This SFC is not valid for the module selected by <i>LADDR</i> and <i>IOID</i> .
80A1h	Negative acknowledgement when the record is being transferred to the module (module was removed during the transfer or module failed).
80A2h	DP protocol fault in layer 2, possible hardware-/ interface fault in the DP slave.
80A3h	DP protocol fault for user Interface/user.
80A4h	Communication failure (this fault occurs between the CPU and the external DP interface).
80B0h	SFC cannot be used with this type of module or the module does not recognize the record.
80B1h	The length of the target area determined by <i>RECORD</i> is too small.
80B2h	The slot that was configured has not been populated.
80B3h	The actual type of module is not equal to the required type of module in SDB1
80C1h	The module has not yet completed processing of the data of the preceding write operation for the same record.
80C2h	The module is currently processing the maximum number of jobs for a CPU.
80C3h	Required resources (memory, etc.) are currently occupied.
80C4h	Communication error.
80C5h	Decentralized periphery not available.
80C6h	The transfer of records was aborted due to a priority class abort.
80D0h	The respective SDB does not contain an entry for the module.
80D1h	The record number was not configured in the respective SDB.
80D2h	Based on the type identifier the module cannot be configured.

Value	Description
80D3h	The SDB cannot be accessed since it does not exist.
80D4h	Bad SDB structure: the SDB internal pointer points to an element outside of the SDB.
80D5h	The record is static.

14.1.44 SFC 56 - WR_DPARM - Write default parameter

Description

The SFC 56 WR_DPARM (write default parameter) transfers the record *RECNUM* from the respective SDB to the target module, irrespective of whether the specific record is static or dynamic.

These SFC can be used for digital-, analog modules, FMs, CPs and via PROFIBUS DP-V1.

Parameters

Parameter	Declaration	Data type	Memory block	Description
REQ	INPUT	BOOL	I, Q, M, D, L, constant	<i>REQ</i> = 1: write request
IOID	INPUT	BYTE	I, Q, M, D, L, constant	Identifier for the address space: 54h = peripheral input (PI) 55h = peripheral output (PQ) For hybrid modules the SFC returns the area identifier of the lower address. When the addresses are equal the SFC returns identifier 54h.
LADDR	INPUT	WORD	I, Q, M, D, L, constant	Logical base address of the module. For hybrid modules the lower of the two addresses must be specified.
RECNUM	INPUT	BYTE	I, Q, M, D, L, constant	Record number (valid values: 0 ... 240)
RET_VAL	OUTPUT	INT	I, Q, M, D, L	The return value contains an error code if an error is detected when the function is being processed.
BUSY	OUTPUT	BOOL	I, Q, M, D, L	<i>BUSY</i> = 1: the write operation has not been completed.

RET_VAL (Return value)

Two distinct cases exist for *RET_VAL* = 8xxxh:

- Temporary error (error codes 80A2h ... 80A4h, 80Cxh):
For this type of error it is possible that the error corrects itself without intervention. For this reason it is recommended that you re-issue the call to the SFC (once or more than once).
Example for temporary errors: the required resources are occupied at present (80C3h).
- Permanent error (error codes 809xh, 80A1h, 80Bxh, 80Dxh):
These errors cannot be corrected without intervention. A repeat of the call to the SFC is only meaningful when the error has been removed.
Example for permanent errors: incorrect length of the record that must be transferred (80B1h).

Value	Description
7000h	First call with <i>REQ</i> = 0: data transfer not active; <i>BUSY</i> is set to 0.
7001h	First call with <i>REQ</i> = 1: data transfer initiated; <i>BUSY</i> is set to 1.
7002h	Intermediate call (<i>REQ</i> irrelevant): data transfer active; <i>BUSY</i> is set to 1.
8090h	The specified logical base address is invalid: no assignment available in SDB1/SDB2x, or this is not a base address.
8093h	This SFC is not valid for the module selected by means of <i>LADDR</i> and <i>IOID</i> .
80A1h	Negative acknowledgement when the record is being transferred to the module (module was removed during the transfer or module failed)
80A2h	DP protocol fault in layer 2, possible hardware- / interface fault in the DP slave.
80A3h	DP protocol fault for user Interface/user.
80A4h	Communication failure (this fault occurs between the CPU and the external DP interface).
80B0h	SFC cannot be used with this type of module or the module does not recognize the record.
80B1h	The length of the target area determined by <i>RECORD</i> is too small.
80B2h	The slot that was configured has not been populated.
80B3h	The actual type of module is not equal to the required type of module in SDB1.
80C1h	The module has not yet completed processing of the data of the preceding write operation for the same record.
80C2h	The module is currently processing the maximum number of jobs for a CPU.
80C3h	Required resources (memory, etc.) are currently occupied.
80C4h	Communication error.
80C5h	Decentralized periphery not available.
80C6h	The transfer of records was aborted due to a priority class abort.
80D0h	The respective SDB does not contain an entry for the module.
80D1h	The record number was not configured in the respective SDB.
80D2h	Based on the type identifier the module cannot be configured.

Value	Description
80D3h	The SDB cannot be accessed since it does not exist.
80D4h	Bad SDB structure: the SDB internal pointer points to an element outside of the SDB.

14.1.45 SFC 57 - PARM_MOD - Parameterize module

Description

The SFC 57 PARM_MOD (parameterize module) transfers all the records that were configured in the respective SDB into a module, irrespective of whether the specific record is static or dynamic.

These SFC can be used for digital-, analog modules, FMs, CPs and via PROFIBUS DP-V1.

Parameters

Parameter	Declaration	Data type	Memory block	Description
REQ	INPUT	BOOL	I, Q, M, D, L, constant	REQ = 1: write request
IOID	INPUT	BYTE	I, Q, M, D, L, constant	Identifier for the address space: 54h = peripheral input (PI) 55h = peripheral output (PQ) For hybrid modules the SFC returns the area identifier of the lower address. When the addresses are equal the SFC returns identifier 54h.
LADDR	INPUT	WORD	I, Q, M, D, L, constant	Logical base address of the module. For hybrid modules the lower of the two addresses must be specified.
RET_VAL	OUTPUT	INT	I, Q, M, D, L	The return value contains an error code if an error is detected when the function is being processed.
BUSY	OUTPUT	BOOL	I, Q, M, D, L	BUSY = 1: the write operation has not been completed.

- RET_VAL (Return value)** Two distinct cases exist for *RET_VAL* = 8xxxh:
- Temporary error (error codes 80A2h ... 80A4h, 80Cxh):
For this type of error it is possible that the error corrects itself without intervention. For this reason it is recommended that you re-issue the call to the SFC (once or more than once).
Example for temporary errors: the required resources are occupied at present (80C3h).
 - Permanent error (error codes 809xh, 80A1h, 80Bxh, 80Dxh):
These errors cannot be corrected without intervention. A repeat of the call to the SFC is only meaningful when the error has been removed.
Example for permanent errors: incorrect length of the record that must be transferred (80B1h).

Value	Description
7000h	First call with <i>REQ</i> = 0: data transfer not active; <i>BUSY</i> is set to 0.
7001h	First call with <i>REQ</i> = 1: data transfer initiated; <i>BUSY</i> is set to 1.
7002h	Intermediate call (<i>REQ</i> irrelevant): data transfer active; <i>BUSY</i> is set to 1.
8090h	The specified logical base address is invalid: no assignment available in SDB1/SDB2x, or this is not a base.
8093h	This SFC is not valid for the module selected by means of <i>LADDR</i> and <i>IOID</i> .
80A1h	Negative acknowledgement when the record is being transferred to the module (module was removed during the transfer or module)
80A2h	DP protocol fault in layer 2, possible hardware- / interface fault in the DP slave
80A3h	DP protocol fault for user Interface/user
80A4h	Communication failure (this fault occurs between the CPU and the external DP interface)
80B0h	SFC cannot be used with this type of module or the module does not recognize the record.
80B1h	The length of the target area determined by <i>RECORD</i> is too small.
80B2h	The slot that was configured has not been populated.
80B3h	The actual type of module is not equal to the required type of module in SDB1
80C1h	The module has not yet completed processing of the data of the preceding write operation for the same record.
80C2h	The module is currently processing the maximum number of jobs for a CPU.
80C3h	Required resources (memory, etc.) are currently occupied.
80C4h	Communication error
80C5h	Decentralized periphery not available.
80C6h	The transfer of records was aborted due to a priority class abort.
80D0h	The respective SDB does not contain an entry for the module.
80D1h	The record number was not configured in the respective SDB.
80D2h	Based on the type identifier the module cannot be configured.

Value	Description
80D3h	The SDB cannot be accessed since it does not exist.
80D4h	Bad SDB structure: the SDB internal pointer points to an element outside of the SDB.

14.1.46 SFC 58 - WR_REC - Write record

Description

The SFC 58 WR_REC (write record) transfers the record *RECORD* into the selected module.

The write operation is started when input parameter *REQ* is set to 1 when the call to the SFC 58 is issued.

Output parameter *BUSY* returns a value of 0 if the write operation was executed immediately. *BUSY* is set to 1 if the write operation could not be completed.

These SFC can be used for digital-, analog modules, FMs, CPs and via PROFIBUS DP-V1.

System dependent this block cannot be interrupted!

Parameters

Parameter	Declaration	Data type	Memory block	Description
REQ	INPUT	BOOL	I, Q, M, D, L, constant	REQ = 1: write request
IOID	INPUT	BYTE	I, Q, M, D, L, constant	Identifier for the address space: 54h = peripheral input (PI) 55h = peripheral output (PQ) For hybrid modules the SFC returns the area identifier of the lower address. When the addresses are equal the SFC returns identifier 54h.
LADDR	INPUT	WORD	I, Q, M, D, L, constant	Logical base address of the module. For hybrid modules the lower of the two addresses must be specified.
RECNUM	INPUT	BYTE	I, Q, M, D, L, constant	Record number (valid range: 2 ... 240)
RECORD	INPUT	ANY	I, Q, M, D, L	Record Only data type BYTE is valid
RET_VAL	OUTPUT	INT	I, Q, M, D, L	The return value contains an error code if an error is detected when the function is being processed.
BUSY	OUTPUT	BOOL	I, Q, M, D, L	BUSY = 1: the write operation has not been completed.

RECORD

With the first call to the SFC the data that must be transferred is read from the parameter *RECORD*. However, if the transfer of the record should require more than one call duration, the contents of the parameter *RECORD* is no longer valid for subsequent calls to the SFC (of the same job).

RET_VAL (Return value)

Two distinct cases exist for RET_VAL = 8xxxh:

- Temporary error (error codes 80A2h ... 80A4h, 80C3h):
For this type of error it is possible that the error corrects itself without intervention. For this reason it is recommended that you re-issue the call to the SFC (once or more than once).
Example for temporary errors: the required resources are occupied at present (80C3h).
- Permanent error (error codes 809xh, 80A0, 80A1h, 80Bxh):
These errors cannot be corrected without intervention. A repeat of the call to the SFC is only meaningful when the error has been removed.
Example for permanent errors: incorrect length of the record that must be transferred (80B1h).

Value	Description
7000h	First call with <i>REQ</i> = 0: data transfer not active; <i>BUSY</i> is set to 0.
7001h	First call with <i>REQ</i> = 1: data transfer initiated; <i>BUSY</i> is set to 1.
7002h	Intermediate call (<i>REQ</i> irrelevant): data transfer active; <i>BUSY</i> is set to 1.
8090h	The specified logical base address is invalid: no assignment available in SDB1/SDB2x, or this is not a base address.
8092h	ANY-reference contains a type definition that is not equal to BYTE.
8093h	This SFC is not valid for the module selected by <i>LADDR</i> and <i>IOID</i> .
80A1h	Negative acknowledgement when the record is being transferred to the module (module was removed during the transfer or module failed)
80A2h	DP protocol fault in layer 2, possible hardware-/ interface fault in the DP slave
80A3h	DP protocol fault for user Interface/user
80A4h	Communication failure (this fault occurs between the CPU and the external DP interface)
80B0h	SFC not valid for the type of module. Module does not recognize the record. Record number ≥ 241 not permitted. Records 0 and 1 not permitted.
80B1h	The length specified in parameter <i>RECORD</i> is wrong.
80B2h	The slot that was configured has not been populated.
80B3h	The actual type of module is not equal to the required type of module in SDB1
80C1h	The module has not yet completed processing of the data of the preceding write operation for the same record.
80C2h	The module is currently processing the maximum number of jobs for a CPU.
80C3h	Required resources (memory, etc.) are currently occupied.
80C4h	Communication error

Value	Description
80C5h	Decentralized periphery not available.
80C6h	The transfer of records was aborted due to a priority class abort.



A general error 8544h only indicates that access to at least one byte of I/O memory containing the record was disabled. However, the data transfer was continued.

14.1.47 SFC 59 - RD_REC - Read record

Description

The SFC 59 RD_REC (read record) reads the record with the number *RECNUM* from the selected module.

These SFC can be used for digital-, analog modules, FMs, CPs and via PROFIBUS DP-V1.

The read operation is started when input parameter *REQ* is set to 1 when the call to SFC 59 is issued. Output parameter *BUSY* returns a value of 0 if the read operation was executed immediately. *BUSY* is set to 1 if the read operation could not be completed. Parameter *RECORD* determines the target area where the record is saved when it has been transferred successfully.

System dependent this block cannot be interrupted!

Parameters

Parameter	Declaration	Data type	Memory block	Description
REQ	INPUT	BOOL	I, Q, M, D, L, constant	<i>REQ</i> = 1: read request
IOID	INPUT	BYTE	I, Q, M, D, L, constant	Identifier for the address space: 54h = peripheral input (PI) 55h = peripheral output (PQ) For hybrid modules the SFC returns the area identifier of the lower address. When the addresses are equal the SFC returns identifier 54h.
LADDR	INPUT	WORD	I, Q, M, D, L, constant	Logical base address of the module. For hybrid modules the lower of the two addresses must be specified.
RECNUM	INPUT	BYTE	I, Q, M, D, L, constant	Record number (valid range: 0 ... 240)
RET_VAL	OUTPUT	INT	I, Q, M, D, L	The return value contains an error code if an error is detected when the function is being processed. Additionally: the length of the actual record that was read, in bytes (range: +1 ... +240), provided that the target area is greater than the transferred record and that no communication errors have occurred.

Parameter	Declaration	Data type	Memory block	Description
BUSY	OUTPUT	BOOL	I, Q, M, D, L	<i>BUSY</i> = 1: the write operation has not been completed.
RECORD	OUTPUT	ANY	I, Q, M, D, L	Target area for the record that was read. When SFC 59 is processed in asynchronous mode you must ensure that the actual parameters of <i>RECORD</i> have the same length information for all calls. Only data type BYTE is permitted.

Suitable choice of RECORD

To ensure that an entire record is read you must select a target area with a length of 241bytes. In this case the value in *RET_VAL* indicates the actual length of the data that was transferred successfully.

RET_VAL (Return value)

RET_VAL contains an error code when an error occurs while the function was being processed.

When the transfer was successful *RET_VAL* contains:

- a value of 0 if the entire target area was filled with data from the selected record (the record may, however, be incomplete).
- the length of the record that was transferred, in bytes (valid range: 1 ... 240), provided that the target area is greater than the transferred record.

Error information

Two distinct cases exist for *RET_VAL* = 8xxxh:

- Temporary error (error codes 80A2h ... 80A4h, 80Cxh):
For this type of error it is possible that the error corrects itself without intervention. For this reason it is recommended that you re-issue the call to the SFC (once or more than once).
Example for temporary errors: the required resources are occupied at present (80C3h).
- Permanent error (error codes 809xh, 80A0h, 80A1h, 80Bxh):
These errors cannot be corrected without intervention. A repeat of the call to the SFC is only meaningful when the error has been removed.
Example for permanent errors: incorrect length of the record that must be transferred (80B1h).

Error information

Value	Description
7000h	First call with <i>REQ</i> = 0: data transfer not active; <i>BUSY</i> is set to 0.
7001h	First call with <i>REQ</i> = 1: data transfer initiated; <i>BUSY</i> is set to 1.
7002h	Intermediate call (<i>REQ</i> irrelevant): data transfer active; <i>BUSY</i> is set to 1.
8090h	The specified logical base address is invalid: no assignment available in SDB1/SDB2x, or this is not a base address.
8092h	ANY-reference contains a type definition that is not equal to BYTE.
8093h	This SFC is not valid for the module selected by <i>LADDR</i> and <i>IOID</i> .

Value	Description
80A0h	Negative acknowledgment when reading from the module (module was removed during the transfer or module failed).
80A2h	DP protocol fault in layer 2, possible hardware-/ interface fault in the DP slave.
80A3h	DP protocol fault for user Interface/user.
80A4h	Communication failure (this fault occurs between the CPU and the external DP interface).
80B0h	SFC not valid for the type of module. Module does not recognize the record. Record number ≥ 241 not permitted.
80B1h	The length specified in parameter <i>RECORD</i> is wrong.
80B2h	The slot that was configured has not been populated.
80B3h	The actual type of module is not equal to the required type of module in SDB1
80C0h	The module has registered the record but this does not contain any read data as yet.
80C1h	The module has not yet completed processing of the data of the preceding write operation for the same record.
80C2h	The module is currently processing the maximum number of jobs for a CPU.
80C3h	Required resources (memory, etc.) are currently occupied.
80C4h	Communication error.
80C5h	Decentralized periphery not available.
80C6h	The transfer of records was aborted due to a priority class abort.



A general error 8745h only indicates that access to at least one byte of I/O memory containing the record was disabled. However, the data was read successfully from the module and saved to the I/O memory block.

14.1.48 SFC 64 - TIME_TCK - Read system time tick

Description

The SFC 64 TIME_TCK (time tick) retrieves the system time tick from the CPU. This may be used to assess the time that certain processes require calculating the difference between the values returned by two SFC 64 calls. The system time is a "time counter" that counts from 0 to a max. of 2147483647ms and that restarts from 0 when an overflow occurs. The timing intervals and the accuracy of the system time depend on the CPU. Only the operating modes of the CPU influence the system time.

System time and operating modes

Operating mode	System time ...
Restart RUN	... permanently updated.
STOP	... stopped to retain the last value.
Reboot	... is deleted and starts from "0".

Parameters

Parameter	Declaration	Data type	Memory block	Description
RET_VAL	OUTPUT	TIME	I, Q, M, D, L	Parameter <i>RET_VAL</i> contains the system time that was retrieved, range from 0 ... 2^{31} -1ms.

RET_VAL (Return value) The SFC 64 does not return any error information.

14.1.49 SFC 65 - X_SEND - Send data

Description

The SFC 65 X_SEND can be used to send data to an external communication partner outside the local station. The communication partner receives the data by means of the SFC 66 X_RCV. Input parameter *REQ_ID* is used to identify the transmit data. This code is transferred along with the transmit data and it can be analyzed by the communication partner to determine the origin of the data. The transfer is started when input parameter *REQ* is set to 1. The size of the transmit buffer that is defined by parameter *SD* (on the sending CPU) must be less than or equal to the size of the receive buffer (on the communication partner) that was defined by means of parameter *RD*. In addition, the data type of the transmit buffer and the receive buffer must be identical.

Parameters

Parameter	Declaration	Data type	Memory block	Description
REQ	INPUT	BOOL	I, Q, M, D, L, constant	control parameter "request to activate", initiates the operation
CONT	INPUT	BOOL	I, Q, M, D, L, constant	control parameter "continue", defines whether the connection to the communication partner is terminated or not when the operation has been completed
DEST_ID	INPUT	WORD	I, Q, M, D, L, constant	Address parameter "destination ID". Contains the MPI-address of the communication partners.
REQ_ID	INPUT	DWORD	I, Q, M, D, L, constant	Operation code identifying the data on the communication partner.
SD	INPUT	ANY	I, Q, M, D	Reference to the send buffer. The following data types are possible: BOOL, BYTE, CHAR, WORD, INT, DWORD, DINT, REAL, DATE, TOD, TIME, S5_TIME, DATE_AND_TIME as well as arrays of the respective data types, with the exception of BOOL.
RET_VAL	OUTPUT	INT	I, Q, M, D, L	The return value contains an error code if an error is detected when the function is being processed.
BUSY	OUTPUT	BOOL	I, Q, M, D, L	<i>BUSY</i> = 1: the send operation has not yet been completed. <i>BUSY</i> = 0: the send operation has been completed, or no send operation is active.

REQ_ID

Input parameter *REQ_ID* identifies the send data.

Parameter *REQ_ID* is required by the receiver when

- the sending CPU issues multiple calls to SFC 65 with different REQ_ID parameters and the data is transferred to a single communication partner.
- more than one sending CPU are transferring data to a communication partner by means of the SFC 65.

Receive data can be saved into different memory blocks by analyzing the *REQ_ID* parameter.

Data consistency

Since send data is copied into an internal buffer of the operating system when the first call is issued to the SFC it is important to ensure that the send buffer is not modified before the first call has been completed successfully. Otherwise an inconsistency could occur in the transferred data.

Any write-access to send data that occurs after the first call is issued does not affect the data consistency.

RET_VAL (Return value)

The return value contains an error code if an error is detected when the function is being processed.

The "real error information" that is contained in the table "specific error information" a. o. may be classified as follows:

Value	Description
809xh	Error on the CPU where the SFC is being executed.
80Axh	Permanent communication error.
80Bxh	Error on the communication partner.
80Cxh	Temporary error.

Specific error information:

Value	Description
0000h	Processing completed without errors.
7000h	First call with <i>REQ</i> = 0: no data transfer is active; <i>BUSY</i> is set to 0.
7001h	First call with <i>REQ</i> = 1: data transfer initiated; <i>BUSY</i> is set to 1.
7002h	Intermediate call (<i>REQ</i> irrelevant): data transfer active; <i>BUSY</i> is set to 1.
8090h	The specified target address of the communication partners is not valid, e.g. <ul style="list-style-type: none"> ■ bad <i>IOID</i> ■ bad base address exists ■ bad MPI-address (> 126)
8092h	Error in <i>SD</i> or <i>RD</i> , e.g.: <ul style="list-style-type: none"> ■ illegal length for <i>SD</i> ■ <i>SD</i> = NIL is not permitted
8095h	The block is already being processed on a priority class that has a lower priority.
80A0h	Error in received acknowledgement.
80A1h	Communication failures: SFC-call after an existing connection has been terminated.
80B1h	ANY-pointer error. The length of the data buffer that must be transferred is wrong.

Value	Description
80B4h	ANY-pointer data type error, or ARRAY of the specified data type is not permitted.
80B5h	Processing rejected because of an illegal operating mode.
80B6h	The received acknowledgement contains an unknown error code.
80B8h	The SFC 66 "X_RCV" of the communication partner rejected the data transfer (<i>RD</i> = NIL).
80B9h	The data block was identified by the communication partner (SFC 66 "X_RCV" was called with <i>EN_DT</i> = 0) but it has not yet been accepted into the application program because the operating mode is STOP.
80BAh	The answer of the communication partner does not fit into the communication telegram.
80C0h	The specified connection is already occupied by another operation.
80C1h	Lack of resources on the CPU where the SFC is being executed, e.g.: <ul style="list-style-type: none"> the module is already executing the maximum number of different send operations. Connection resources may be occupied, e.g. by a receive operation.
80C2h	Temporary lack of resources for the communication partner, e.g.: <ul style="list-style-type: none"> The communication partner is currently processing the maximum number of operations. The required resources (memory, etc.) are already occupied. Not enough memory (initiate compression).
80C3h	Error when establishing a connection, e.g.: <ul style="list-style-type: none"> The local station is connected to the MPI sub-net. You have addressed the local station on the MPI sub-net. The communication partner cannot be contacted any longer. Temporary lack of resources for the communication partner.

14.1.50 SFC 66 - X_RCV - Receive data

Description

The SFC 66 X_RCV can be used to receive data, that was sent by means of SFC 65 X_SEND by one or more external communication partners.

SFC 66 can determine whether the data that was sent is available at the current point in time. The operating system could have stored the respective data in an internal queue. If the data exists in the queue the oldest data block can be copied into the specified receive buffer.

Parameters

Parameter	Declaration	Data type	Memory block	Description
EN_DT	INPUT	BOOL	I, Q, M, D, L, constant	Control parameter "enable data transfer". You can check whether one or more data blocks are available by setting this to 0. A value of 1 results in the oldest data block of the queue being copied into the memory block that was specified by means of <i>RD</i> .
RET_VAL	OUTPUT	INT	I, Q, M, D, L	The return value contains an error code if an error is detected when the function is being processed.
REQ_ID	OUTPUT	DWORD	I, Q, M, D, L	Operation code of the SFC 65 "X_SEND" whose send data is located uppermost in the queue, i.e. the oldest data in the queue. If the queue does not contain a data block <i>REQ_ID</i> is set to 0.

Parameter	Declaration	Data type	Memory block	Description
NDA	OUTPUT	BOOL	I, Q, M, D, L	Status parameter "new data arrived". NDA = 0: <ul style="list-style-type: none"> The queue does not contain a data block. NDA = 1: <ul style="list-style-type: none"> The queue does contain one or more data blocks. (call to the SFC 66 with EN_DT = 0) The oldest data block in the queue was copied into the application program. (call to the SFC 66 with EN_DT = 1)
RD	OUTPUT	ANY	I, Q, M, D	Reference to the receive data buffer (receive data area). The following data types are available: BOOL, BYTE, CHAR, WORD, INT, DWORD, DINT, REAL, DATE, TOD, TIME, S5_TIME, DATE_AND_TIME as well as arrays of these data types with the exception of BOOL. If you wish to discard the oldest data block in the queue you must assign a value of NIL to RD.

Data reception indication with EN_DT = 0

The operating system inserts data received from a communication partner in the sequence in which they are received.

You can test whether at least one data block is ready by issuing a call to the SFC 66 with EN_DT = 0 and testing the resulting output parameter NDA.

- NDA = 0 means that the queue does not contain a data block. REQ_ID is irrelevant, RET_VAL contains a value of 7000h.
- NDA = 1 means that the queue does contain one or more data blocks.

If the queue contains a data block you should also test output parameters RET_VAL and REQ_ID. RET_VAL contains the length of the data block in bytes, REQ_ID contains the operation code of the send block. If the queue should contain multiple data blocks parameters REQ_ID and RET_VAL refer to the oldest data block contained in the queue.

Transferring data into the receive buffer with EN_DT = 1

When input parameter EN_DT = 1 then the oldest data block in the queue is copied into the target block defined by RD. You must ensure that the size of RD is greater than or equal to the size of the transmit buffer of the respective SFC 65 X_SEND defined by parameter SD and that the data types match. If received data should be saved into different areas you can determine the REQ_ID in the first call (SFC-call with EN_DT = 0) and select a suitable value for RD in the subsequent call (with EN_DT = 1). If the operation was processed successfully RET_VAL contains the length (in bytes) of data block that was copied and a positive acknowledgement is returned to the sending station.

Discarding data

If you do not want to accept the received data assign a value of NIL to RD. The respective communication partner receives a negative acknowledgement

(the value of RET_VAL of the respective SFC 65 X_SEND is 80B8h) and parameter RET_VAL is set to 0.

- Data consistency** You must make sure that the receive buffer is not read before the operation has been completed since you could otherwise be reading could cause inconsistent data.
- Operating mode transition to STOP mode** When the CPU changes to STOP mode,
- all newly received commands receive a negative acknowledgement.
 - for commands that have already been received: all commands that have been entered into the in receive queue receive a negative acknowledgement.
 - all data blocks are discarded when a new start follows.
- Termination of a connection** When the connection is terminated any operation that was entered into the receive queue of this connection is discarded.
- Exception: if this is the oldest operation in the queue that has already been recognized by a SFC-call with *EN_DT* = 0 it can be transferred into the receive buffer by means of *EN_DT* = 1.
- RET_VAL (Return value)** If no error has occurred, *RET_VAL* contains:
- when *EN_DT* = 0/1 and *NDA* = 0: 7000h. In this case the queue does not contain a data block.
 - when *EN_DT* = 0 and *NDA* = 1, *RET_VAL* contains the length (in bytes) of the oldest data block that was entered into the queue as a positive number.
 - when *EN_DT* = 1 and *NDA* = 1, *RET_VAL* contains the length (in bytes) of the data block that was copied into the receive buffer *RD* as a positive number.

Error information

The "real error information" that is contained in the table "specific error information" a. o. may be classified as follows:

Value	Description
809xh	Error on the CPU where the SFC is being executed
80Axh	Permanent communication error
80Bxh	Error on the communication partner
80Cxh	Temporary error

Specific Error information:

Value	Description
0000h	Processing completed without errors.
00xyh	When <i>NDA</i> = 1 and <i>RD</i> <> NIL: <i>RET_VAL</i> contains the length of the received data block (when <i>EN_DT</i> = 0) or the data block copied into <i>RD</i> (when <i>EN_DT</i> = 1).
7000h	<i>EN_DT</i> = 0/1 and <i>NDA</i> = 0
7001h	First call with <i>REQ</i> = 1: data transfer initiated; <i>BUSY</i> is set to 1.
7002h	Intermediate call (<i>REQ</i> irrelevant): data transfer active; <i>BUSY</i> is set to 1.

Value	Description
8090h	The specified target address of the communication partners is not valid, e.g. <ul style="list-style-type: none"> ■ bad <i>IOID</i> ■ bad base address exists ■ bad MPI-address (> 126)
8092h	Error in <i>SD</i> or <i>RD</i> , e.g.: <ul style="list-style-type: none"> ■ The amount of data received is too much for the buffer defined by <i>RD</i>. ■ <i>RD</i> has data type <i>BOOL</i> but the length of the received data is greater than one byte.
8095h	The block is already being processed on a priority class that has a lower priority.
80A0h	Error in received acknowledgment.
80A1h	Communication failures: SFC-call after an existing connection has been terminated.
80B1h	ANY-pointer error. The length of the data block that must be transferred is wrong.
80B4h	ANY-pointer data type error, or <i>ARRAY</i> of the specified data type is not permitted.
80B6h	The received acknowledgment contains an unknown error code.
80BAh	The answer of the communication partner does not fit into the communication telegram.
80C0h	The answer of the communication partner does not fit into the communication telegram.
80C1h	Lack of resources on the CPU where the SFC is being executed, e.g.: <ul style="list-style-type: none"> ■ the module is already executing the maximum number of different send operations. ■ connection resources may be occupied, e.g. by a receive operation.
80C2h	Temporary lack of resources for the communication partner, e.g.: <ul style="list-style-type: none"> ■ The communication partner is currently processing the maximum number of operations. ■ The required resources (memory, etc.) are already occupied. ■ Not enough memory (initiate compression).
80C3h	Error when establishing a connection, e.g.: <ul style="list-style-type: none"> ■ The local station is connected to the MPI sub-net. ■ You have addressed the local station on the MPI sub-net. ■ The communication partner cannot be contacted any longer. ■ Temporary lack of resources for the communication partner.

14.1.51 SFC 67 - X_GET - Read data

Description

The SFC 67 X_GET can be used to read data from an external communication partner that is located outside the local station. No relevant SFC exists on the communication partner. The operation is started when input parameter *REQ* is set to 1. Thereafter the call to the SFC 67 is repeated until the value of output parameter *BUSY* becomes 0.

Output parameter *RET_VAL* contains the length of the received data block in bytes.

The length of the receive buffer defined by parameter *RD* (in the receiving CPU) must be identical or greater than the read buffer defined by parameter *VAR_ADDR* (for the communication partner) and the data types of *RD* and *VAR_ADDR* must be identical.

Parameters

Parameter	Declaration	Data type	Memory block	Description
REQ	INPUT	BOOL	I, Q, M, D, L, constant	Control parameter "request to activate", used to initiate the operation.
CONT	INPUT	BOOL	I, Q, M, D, L, constant	Control parameter "continue", determines whether the connection to the communication partner is terminated or not when the operation has been completed.
DEST_ID	INPUT	WORD	I, Q, M, D, L, constant	Address parameter "destination ID". Contains the MPI address of the communication partner.
VAR_ADDR	INPUT	ANY	I, Q, M, D	Reference to the buffer in the partner-CPU from where data must be read. You must select a data type that is supported by the communication partner.
RET_VAL	OUTPUT	INT	I, Q, M, D, L	The return value contains an error code if an error is detected when the function is being processed. If no error has occurred, <i>RET_VAL</i> contains the length of the data block that was copied into receive buffer RD as positive number of bytes.
BUSY	OUTPUT	BOOL	I, Q, M, D, L	<i>BUSY</i> = 1: the receive operation has not been completed. <i>BUSY</i> = 0: the receive operation has been completed or no receive operation active.
RD	OUTPUT	ANY	I, Q, M, D	Reference to the receive buffer (receive data area). The following data types are permitted: BOOL, BYTE, CHAR, WORD, INT, DWORD, DINT, REAL, DATE, TOD, TIME, S5_TIME, DATE_AND_TIME as well as arrays of the above data types, with the exception of BOOL

Data consistency

The following rules must be satisfied to prevent the data consistency from being compromised:

- Active CPU (receiver of data):
The receive buffer should be read in the OB that issues the call to the respective SFC. If this is not possible the receive buffer should only be read when processing of the respective SFC has been completed.
- Passive CPU (sender of data):
The maximum amount of data that may be written into the send buffer is determined by the block size of the passive CPU (sender of data).
- Passive CPU (sender of data):
Send data should be written to the send buffer while interrupts are inhibited.

Operating mode transition to STOP mode

When the CPU changes to STOP mode the connection established by means of the SFC 67 is terminated. The type of start-up that follows determines whether any previously received data located in a buffer of the operating system are discarded or not.

A reboot start means that the data is discarded.

Operating mode transition of the communication partners to STOP mode A transition to operating mode STOP of the CPU of the communication partner does not affect the data transfer, since it is also possible to read data in operating mode STOP.

RET_VAL (Return value) The "real error information" that is contained in the table "specific error information" may be classified as follows:

Value	Description
809xh	Error on the CPU where the SFC is being executed
80Axh	Permanent communication error
80Bxh	Error on the communication partner
80Cxh	Temporary error

Specific error information:

Value	Description
0000h	Processing completed without errors.
00xyh	<i>RET_VAL</i> contains the length of the received data block.
7000h	Call issued with <i>REQ</i> = 0 (call without processing), <i>BUSY</i> is set to 0, no data transfer is active.
7001h	First call with <i>REQ</i> = 1: Data transfer started; <i>BUSY</i> has the value 1.
7002h	Intermediate call (<i>REQ</i> irrelevant): data transfer active; <i>BUSY</i> is set to 1.
8090h	The specified target address of the communication partners is not valid, e.g.: <ul style="list-style-type: none"> ■ bad <i>IOID</i> ■ bad base address exists ■ bad MPI-address (> 126)
8092h	Error in <i>SD</i> or <i>RD</i> , e.g.: <ul style="list-style-type: none"> ■ illegal length for <i>RD</i> ■ the length or the data type of <i>RD</i> does not correspond with the received data. ■ <i>RD</i> = NIL is not permitted.
8095h	The block is already being processed on a priority class that has a lower priority.
80A0h	Error in received acknowledgement.
80A1h	Communication failures: SFC-call after an existing connection has been terminated.
80B0h	Object cannot be found, e.g. DB was not loaded.
80B1h	ANY-pointer error. The length of the data block that must be transferred is wrong.
80B2h	HW-error: module does not exist <ul style="list-style-type: none"> ■ The slot that was configured is empty. ■ Actual module type does not match the required module type. ■ Decentralized periphery not available. ■ The respective SDB does not contain an entry for the module.
80B3h	Data may only be read or written, e.g. write protected DB.

Value	Description
80B4h	The communication partner does not support the data type specified in <i>VAR_ADDR</i> .
80B6h	The received acknowledgment contains an unknown error code.
80BAh	The answer of the communication partner does not fit into the communication telegram.
80C0h	The specified connection is already occupied by another operation.
80C1h	Lack of resources on the CPU where the SFC is being executed, e.g.: <ul style="list-style-type: none"> ■ The module is already executing the maximum number of different send operations. ■ Connection resources may be occupied, e.g. by a receive operation.
80C2h	Temporary lack of resources for the communication partner, e.g.: <ul style="list-style-type: none"> ■ The communication partner is currently processing the maximum number of operations. ■ The required resources (memory, etc.) are already occupied. ■ Not enough memory (initiate compression).
80C3h	Error when establishing a connection, e.g.: <ul style="list-style-type: none"> ■ The local station is connected to the MPI sub-net. ■ You have addressed the local station on the MPI sub-net. ■ The communication partner cannot be contacted any longer. ■ Temporary lack of resources for the communication partner.

14.1.52 SFC 68 - X_PUT - Write data

Description

The SFC 68 X_PUT can be used to write data to an external communication partner that is located outside the local station. No relevant SFC exists on the communication partner. The operation is started when input parameter *REQ* is set to 1. Thereafter the call to SFC 68 is repeated until the value of output parameter *BUSY* becomes 0. The length of the send buffer defined by parameter *SD* (in the sending CPU) must be identical or greater than the receive buffer defined by parameter *VAR_ADDR* (for the communication partner) and the data types of *SD* and *VAR_ADDR* must be identical.

Parameters

Parameter	Declaration	Data type	Memory block	Description
REQ	INPUT	BOOL	I, Q, M, D, L, constant	control parameter "request to activate", used to initiate the operation.
CONT	INPUT	BOOL	I, Q, M, D, L, constant	control parameter "continue", determines whether the connection to the communication partner is terminated or not when the operation has been completed.
DEST_ID	INPUT	WORD	I, Q, M, D, L, constant	Address parameter "destination ID". Contains the MPI address of the communication partner.
VAR_ADDR	INPUT	ANY	I, Q, M, D	Reference to the buffer in the partner-CPU into which data must be written. You must select a data type that is supported by the communication partner.

Parameter	Declaration	Data type	Memory block	Description
SD	INPUT	ANY	I, Q, M, D	Reference to the buffer in the local CPU that contains the send data. The following data types are permitted: BOOL, BYTE, CHAR, WORD, INT, DWORD, DINT, REAL, DATE, TOD, TIME, S5_TIME, DATE_AND_TIME as well as arrays of the above data types, with the exception of BOOL.
RET_VAL	OUTPUT	INT	I, Q, M, D, L	The return value contains an error code if an error is detected when the function is being processed.
BUSY	OUTPUT	BOOL	I, Q, M, D, L	<i>BUSY</i> = 1: the send operation has not been completed. <i>BUSY</i> = 0: The send operation has been completed or no send operation is active.

Data consistency

The following rules must be satisfied to prevent the data consistency from being compromised:

- Active CPU (sender of data):
The send buffer should be written in the OB that issues the call to the respective SFC. If this is not possible the send buffer should only be written when processing of the first call to the respective SFC has been completed.
- Active CPU (sender of data):
The maximum amount of data that may be written into the send buffer is determined by the block size of the passive CPU (sender of data).
- Passive CPU (receiver of data):
Receive data should be read from the receive buffer while interrupts are inhibited.

Operating mode transition to STOP mode

When the CPU changes to STOP mode the connection established by means of the SFC 68 is terminated and data can no longer be sent. If the send data had already been copied into the internal buffer when the transition to STOP mode occurs the contents of the buffer is discarded.

Operating mode transition of the partners to STOP mode

A transition to operating mode STOP of the CPU of the communication partner does not affect the data transfer, since it is also possible to write data in operating mode STOP.

RET_VAL (Return value)

The "real error information" that is contained in the table "specific error information" a. o. may be classified as follows:

Value	Description
809xh	Error on the CPU where the SFC is being executed.
80Axh	Permanent communication error.
80Bxh	Error on the communication partner.
80Cxh	Temporary error.

Specific error information:

Value	Description
0000h	Processing completed without errors.
7000h	Call issued with <i>REQ</i> = 0 (call without processing), <i>BUSY</i> is set to 0, no data transfer is active.
7001h	First call with <i>REQ</i> = 1: data transfer initiated; <i>BUSY</i> is set to 1.
7002h	Intermediate call (<i>REQ</i> irrelevant): data transfer active; <i>BUSY</i> is set to 1.
8090h	The specified target address of the communication partners is not valid, e.g. <ul style="list-style-type: none"> ■ bad <i>IOID</i> ■ bad base address exists ■ bad MPI-address (> 126)
8092h	Error in <i>SD</i> or <i>RD</i> , e.g.: <ul style="list-style-type: none"> ■ illegal length of <i>SD</i> ■ <i>SD</i> = NIL is not permitted
8095h	The block is already being processed on a priority class that has a lower priority.
80A0h	The data type specified by <i>SD</i> of the sending CPU is not supported by the communication partner.
80A1h	Communication failures: SFC-call after an existing connection has been terminated.
80B0h	Object cannot be found, e.g. DB was not loaded.
80B1h	ANY-pointer error. The length of the data block that must be transferred is wrong.
80B2h	HW-error: module does not exist <ul style="list-style-type: none"> ■ the slot that was configured is empty. ■ Actual module type does not match the required module type. ■ Decentralized periphery not available. ■ The respective SDB does not contain an entry for the module.
80B3h	Data can either be read or written, e.g. write protected DB.
80B4h	The communication partner does not support the data type specified in <i>VAR_ADDR</i> .
80B6h	The received acknowledgement contains an unknown error code.
80B7h	Data type and / or the length of the transferred data does not fit the buffer in the partner CPU where the data must be written.
80BAh	The answer of the communication partner does not fit into the communication telegram.
80C0h	The specified connection is already occupied by another operation.
80C1h	Lack of resources on the CPU where the SFC is being executed, e.g.: <ul style="list-style-type: none"> ■ the module is already executing the maximum number of different send operations. ■ connection resources may be occupied, e.g. by a receive operation.

Value	Description
80C2h	Temporary lack of resources for the communication partner, e.g.: <ul style="list-style-type: none"> ■ The communication partner is currently processing the maximum number of operations. ■ The required resources (memory, etc.) are already occupied. ■ Not enough memory (initiate compression).
80C3h	Error when establishing a connection, e.g.: <ul style="list-style-type: none"> ■ The local station is connected to the MPI sub-net. ■ You have addressed the local station on the MPI sub-net. ■ The communication partner cannot be contacted any longer. ■ Temporary lack of resources for the communication partner.

14.1.53 SFC 69 - X_ABORT - Disconnect

Description

The SFC 69 X_ABORT can be used to terminate a connection to a communication partner that is located outside the local station, provided that the connection was established by means one of SFCs 65, 67 or 68. The operation is started when input parameter *REQ* is set to 1. If the operation belonging to SFCs 65, 67 or 68 has already been completed (*BUSY* = 0) then the connection related resources occupied by both partners are enabled again when the call to the SFC 69 has been issued.

However, if the respective operation has not yet been completed (*BUSY* = 1), the call to the respective SFC 65, 67 or 68 must be repeated after the connection has been terminated with *REQ* = 0 and *CONT* = 0. The connection resources are only available again when *BUSY* = 0. The SFC 69 can only be called on the side where SFC 65, 67 or 68 is being executed.

Parameters

Parameter	Declaration	Data type	Memory block	Description
REQ	INPUT	BOOL	I, Q, M, D, L, constant	Control parameter "request to activate", used to initiate the operation.
DEST_ID	INPUT	WORD	I, Q, M, D, L, constant	Address parameter "destination ID". Contains the MPI address of the communication partner.
RET_VAL	OUTPUT	INT	I, Q, M, D, L	The return value contains an error code if an error is detected when the function is being processed.
BUSY	OUTPUT	BOOL	I, Q, M, D, L	<i>BUSY</i> = 1: connection termination not yet completed. <i>BUSY</i> = 0: connection termination has been completed.

Operating mode transition to STOP mode

The connection termination initiated by means of the SFC 69 is still completed, even if the CPU changes to STOP mode.

Operating mode transition of the partners to STOP mode

A transition to operating mode STOP of the CPU of the communication partner does not affect the connection termination, the connection is terminated in spite of the change of operating mode.

RET_VAL (Return value) The "real error information" that is contained in the table "specific error information" and others may be classified as follows:

Value	Description
809xh	Error on the CPU where the SFC is being executed
80Axh	Permanent communication error
80Bxh	Error on the communication partner
80Cxh	Temporary error

Specific error information:

Value	Description
0000h	<i>REQ</i> = 1 when the specified connection has not been established.
7000h	Call issued with <i>REQ</i> = 0 (call without processing), <i>BUSY</i> is set to 0, no data transfer is active.
7001h	First call with <i>REQ</i> = 1: data transfer initiated; <i>BUSY</i> is set to 1.
7002h	Intermediate call with <i>REQ</i> = 1.
8090h	The specified target address of the communication partners is not valid, e.g.: <ul style="list-style-type: none"> ■ bad <i>IOID</i> ■ bad base address exists ■ bad MPI-address (> 126)
8095h	The block is already being processed on a priority class that has a lower priority.
80A0h	Error in the acknowledgement that was received.
80A1h	Communication failures: SFC-call after an existing connection has been terminated.
80B1h	ANY-pointer error. The length of the data block that must be transferred is wrong.
80B4h	ANY-pointer data type error, or ARRAY of the specified data type is not permitted.
80B6h	The received acknowledgement contains an unknown error code.
80BAh	The answer of the communication partner does not fit into the communication telegram.
80C0h	The specified connection is already occupied by another operation.
80C1h	Lack of resources on the CPU where the SFC is being executed, e.g.: <ul style="list-style-type: none"> ■ the module is already executing the maximum number of different send operations. ■ connection resources may be occupied, e.g. by a receive operation.

Value	Description
80C2h	Temporary lack of resources for the communication partner, e.g.: <ul style="list-style-type: none"> ■ The communication partner is currently processing the maximum number of operations ■ The required resources (memory, etc.) are already occupied. ■ Not enough memory (initiate compression).
80C3h	Error when establishing a connection, e.g.: <ul style="list-style-type: none"> ■ The local station is connected to the MPI sub-net. ■ You have addressed the local station on the MPI sub-net. ■ The communication partner cannot be contacted any longer. ■ Temporary lack of resources for the communication partner.

14.1.54 SFC 70 - GEO_LOG - Determining the Start Address of a Module

Description

Assumption: the associated module slot of the module is known from the channel of a signal module. With SFC 70 GEO_LOG (convert geographical address to logical address) you can determine the associated start address of the module, that is, the smallest I address or Q address. If you use SFC 70 on power modules or modules with packed addresses, the diagnostic address is returned.

Parameters

Parameter	Declaration	Data Type	Memory Area	Description
MASTER	INPUT	INT	I, Q, M, D, L, constant	Area ID: <ul style="list-style-type: none"> ■ 0, if the slot is located in one of the racks 0-3 (S7-300) or 0 bis 21 (S7-400) ■ 1 to 32: DP master system ID of the associated field device if the slot is located in a field device on PROFIBUS ■ 100 to 115: PROFINET IO system ID of the associated field device if the slot is located in a field device on PROFINET
STATION	INPUT	INT	I, Q, M, D, L, constant	<ul style="list-style-type: none"> ■ No. of rack, if area ID= 0 ■ Station number of field device if area ID > 0
SLOT	INPUT	INT	I, Q, M, D, L, constant	Slot no.
SUBSLOT	INPUT	INT	I, Q, M, D, L, constant	Interface module slot (if no interface module can be inserted, enter 0 here)
RET_VAL	OUTPUT	INT	I, Q, M, D, L	Error information
LADDR	OUTPUT	WORD	I, Q, M, D, L	Start address of the module Bit 15 of LADDR indicates whether an input address (bit 15 = 0) or an output address (bit 15 = 1) is present

RET_VAL (Return value)

Value	Description
0000h	The job was executed without errors.
8094h	No subnet was configured with the specified <i>SUBNETID</i> .
8095h	Invalid value for <i>STATION</i> parameter
8096h	Invalid value for <i>SLOT</i> parameter
8097h	Invalid value for <i>SUBSLOT</i> parameter
8099h	The slot is not configured.
809Ah	The interface module address is not configured for the selected slot.
8xyyh	General error information ↪ Chap. 4.2 'General and Specific Error Information RET_VAL' page 66

14.1.55 SFC 71 - LOG_GEO - Determining the slot belonging to a logical address**Description**

SFC 71 LOG_GEO (convert logical address to geographical address) lets you determine the module slot belonging to a logical address as well as the offset in the user data area of the module.

Parameters

Parameter	Declaration	Data Type	Memory Area	Description
LADDR	INPUT	WORD	I, Q, M, D, L, constant	Any logical address of the module. In bit 15 you indicate whether an input address (bit 15 = 0) or an output address (bit 15 = 1) is present.
RET_VAL	OUTPUT	INT	I, Q, M, D, L,	Error information
AREA	OUTPUT	INT	I, Q, M, D, L,	Area ID: indicates how the remaining parameters are to be interpreted.
MASTER	OUTPUT	INT	I, Q, M, D, L, constant	Area ID: <ul style="list-style-type: none"> ■ 0, if the slot is located in one of the racks 0 - 3 (S7-300) or 0 - 21 (S7-400) ■ 1 to 32: DP master system ID of the associated field device if the slot is located in a field device on PROFIBUS ■ 100 to 115: PROFINET IO system ID of the associated field device if the slot is located in a field device on PROFINET
STATION	OUTPUT	INT	I, Q, M, D, L	<ul style="list-style-type: none"> ■ No. of rack, if area ID= 0 ■ Station number of field device if area ID > 0
SLOT	OUTPUT	INT	I, Q, M, D, L	Slot no.
SUBSLOT	OUTPUT	INT	I, Q, M, D, L	Interface module number
OFFSET	OUTPUT	INT	I, Q, M, D, L	Offset in user data area of the associated module

AREA Output Parameter

Value of AREA	System	Meaning of RACK, SLOT and SUBADDR
0	S7-400	<ul style="list-style-type: none"> ■ <i>MASTER</i>: 0 ■ <i>STATION</i>: Rack no. ■ <i>SLOT</i>: Slot no. ■ <i>SUBSLOT</i>: 0 ■ <i>OFFSET</i>: Difference between the logical address and the logical base address.
1	S7-300	<ul style="list-style-type: none"> ■ <i>MASTER</i>: 0 ■ <i>STATION</i>: Rack no. ■ <i>SLOT</i>: Slot no. ■ <i>SUBSLOT</i>: 0 ■ <i>OFFSET</i>: Difference between the logical address and the logical base address.
2	PROFIBUS DP	<ul style="list-style-type: none"> ■ <i>MASTER</i>: DP master system ID ■ <i>STATION</i>: Station number ■ <i>SLOT</i>: Slot no. in the station ■ <i>SUBSLOT</i>: 0 ■ <i>OFFSET</i>: Offset in user data address area of the associated module
	PROFINET IO	<ul style="list-style-type: none"> ■ <i>MASTER</i>: PROFINET IO-System-ID ■ <i>STATION</i>: Station number ■ <i>SLOT</i>: Slot no. in the station ■ <i>SUBSLOT</i>: Submodulnummer ■ <i>OFFSET</i>: Offset in user data address area of the associated module
3	S5-P area	<ul style="list-style-type: none"> ■ <i>MASTER</i>: 0 ■ <i>STATION</i>: Rack no. ■ <i>SLOT</i>: Slot no. of the adapter module ■ <i>SUBSLOT</i>: 0 ■ <i>OFFSET</i>: Address in the S5 x area
4	S5-Q area	<ul style="list-style-type: none"> ■ <i>MASTER</i>: 0 ■ <i>STATION</i>: Rack no. ■ <i>SLOT</i>: Slot no. of the adapter module ■ <i>SUBSLOT</i>: 0 ■ <i>OFFSET</i>: Address in the S5 x area
5	S5-IM3 area	<ul style="list-style-type: none"> ■ <i>MASTER</i>: 0 ■ <i>STATION</i>: Rack no. ■ <i>SLOT</i>: Slot no. of the adapter module ■ <i>OFFSET</i>: Address in the S5 x area
6	S5-IM4 area	<ul style="list-style-type: none"> ■ <i>MASTER</i>: 0 ■ <i>STATION</i>: Rack no. ■ <i>SLOT</i>: Slot no. of the adapter module ■ <i>SUBSLOT</i>: 0 ■ <i>OFFSET</i>: Address in the S5 x area

RET_VAL (Return value)

Value	Description
0000h	The job was executed without errors.
8090h	Specified logical address invalid
8xyyh	General error information ↪ Chap. 4.2 'General and Specific Error Information RET_VAL' page 66

14.1.56 SFC 81 - UBLKMOV - Copy data area without gaps

Description

The SFC 81 UBLKMOV (uninterruptible block move) creates a consistent copy of the contents of a memory block (= source field) in another memory block (= target field). The copy procedure cannot be interrupted by other activities of the operating system.

It is possible to copy any memory block, with the exception of:

- the following blocks: FB, SFB, FC, SFC, OB, SDB
- counters
- timers
- memory blocks of the peripheral area
- data blocks those are irrelevant to the execution

The maximum amount of data that can be copied is 512bytes.

Interruptibility

It is not possible to interrupt the copy process. For this reason it is important to note that any use of the SFC 81 will increase the reaction time of your CPU to interrupts.

Parameter	Declaration	Data type	Memory block	Description
SRCBLK	INPUT	ANY	I, Q, M, D, L	Specifies the memory block that must be copied (source field). Arrays of data type STRING are not permitted.
RET_VAL	OUTPUT	INT	I, Q, M, D, L	The return value contains an error code if an error is detected when the function is being processed.
DSTBLK	OUTPUT	ANY	I, Q, M, D, L	Specifies the target memory block where the data must be copied (target field). Arrays of data type STRING are not permitted.



The source and target field must not overlap.

If the specified target field is larger than the source field, only the amount of data located in the source field will be copied into the target field.

However, if the size of the specified target field is less than the size of the source field, then only the amount of data that will fit into the target field will be copied.

If the data type of the ANY-pointer (source or target) is BOOL, then the specified length must be divisible by 8, otherwise the SFC will not be executed.

If the data type of the ANY-pointer is STRING the specified length must be 1.

RET_VAL (Return value)

Value	Description
0000h	no error
8091h	The source area is located in a data block that is not relevant to execution.

14.1.57 SFC 101 - RTM - Handling Runtime meters

Description

Call SFC 101 RTM (runtime meter) to set, start, stop and read a 32-bit runtime meter of your CPU. To fetch the values of all 32-bit runtime meters of your CPU, call SFC 51 RDSYSST with SZL_ID=W#16#0132 and INDEX=W#16#000B (for runtime meters 0 ... 7) or INDEX=W#16#000C (for runtime meters 8 ... 15).

Parameters

Parameter	Deklaration	Datentyp	Speicherbereich	Beschreibung
NR	INPUT	BYTE	I, Q, M, D, L, constant	Number of the runtime meter Numbering starts at 0. You will find the number of runtime meters of your CPU in the technical specifications.
MODE	INPUT	BYTE	I, Q, M, D, L, constant	Job ID: <ul style="list-style-type: none"> ■ 0: fetch (the status is then written to CQ and the current value to CV). After the runtime meter has reached (2E31) -1 hours, it stops at the highest value that can be displayed and outputs an "Overflow" error message. ■ 1: start (at the last counter value) ■ 2: stop ■ 4: set (to the value specified in PV) ■ 5: set (to the value specified in PV) and then start ■ 6: set (to the value specified in PV) and then stop
PV	INPUT	DINT	I, Q, M, D, L, constant	New value for the runtime meter

Parameter	Deklaration	Datentyp	Speicherbereich	Beschreibung
RET_VAL	OUTPUT	INT	I, Q, M, D, L	The return value will contain an error code if an error occurs while the function is being processed.
CQ	OUTPUT	BOOL	I, Q, M, D, L	Status of the runtime meter (1: running)
CV	OUTPUT	DINT	I, Q, M, D, L	Current value of the runtime meter

Compatibility to programs for a CPU with 16-bit runtime meters

You can also operate your 32-bit runtime meters with the SFCs 2 SET_RTM, SFC 3 CTRL_RTM and SFC 4 READ_RTM. In this case however, the 32-bit runtime meters operate in the same way as 16-bit meters (Range of values: 0 to 32767 hours). The partial list extract with SSL ID W#16#0132 and index W#16#0008 displays the 32-bit runtime meters 0 to 7 in 16-bit mode. This means that you can continue to use programs developed for a CPU with 16-bit runtime meters that use partial list extract with SSL ID W#16#0132 and index W#16#0008.

RET_VAL (Return value)

Error code	Description
0000h	The job was executed without errors.
8080h	Wrong runtime meter number
8081h	A negative value was passed to parameter <i>PV</i> .
8082h	Overflow of the runtime meter.
8091h	Illegal value in input parameter <i>MODE</i> .
8xyyh	General error information ↳ Chap. 4.2 'General and Specific Error Information RET_VAL' page 66

14.1.58 SFC 102 - RD_DPARA - Reading Predefined Parameters

Description

With SFC 102 RD_DPARA you can read the record set with the number *RECNUM* of a selected module from system data configured with STEP7. The read record set is entered into the target area opened with the parameter *RECORD*.

Operating principle

The SFC 102 RD_DPARA operates asynchronously, that is, processing covers multiple SFC calls.

Start the job by calling SFC 102 with REQ = 1. The job status is displayed via the output parameters *RET_VAL* and *BUSY*. Refer also to Meaning of *REQ*, *RET_VAL* and *BUSY* with Asynchronously Operating SFCs.

Parameters

Parameter	Declaration	Data type	Memory block	Description
REQ	INPUT	BOOL	I, Q, M, D, L	REQ = 1: Read request
LADDR	INPUT	WORD	I, Q, M, D, L, constant	Address of the module. For an output address, the highest value bit must be set.

Parameter	Declaration	Data type	Memory block	Description
RECNUM	INPUT	BYTE	I, Q, M, D, L, constant	Record set number (permitted values: 0 ... 240).
RET_VAL	OUTPUT	INT	I, Q, M, D, L	If an error occurs while the function is active, the return value contains an error code. If no error occurred during the transmission, the following two cases are distinguished: <ul style="list-style-type: none"> ■ <i>RET_VAL</i> contains the length of the actually read record set in bytes if the destination area is larger than the read record set. ■ <i>RET_VAL</i> contains 0 if the length of the read record set is equal to the length of the destination area.
BUSY	OUTPUT	BOOL	I, Q, M, D, L	<i>BUSY</i> = 1: The job is not yet closed.
RECORD	OUTPUT	ANY	I, Q, M, D, L	Destination area for the read record set. Only data type BYTE is permitted. Note: Note that the <i>RECORD</i> parameter of CPUs always required the full specification of the DB parameters. (for example: P#DB13.DBX0.0 byte 100). Omitting an explicit DB number is not permitted for CPUs and causes an error message in the user program.

Error Information

↳ Chap. 14.1.45 'SFC 57 - PARM_MOD - Parameterize module' page 696

14.1.59 SFC 105 - READ_SI - Reading Dynamic System Resources**Overview**

When messages are generated with SFCs 107 ALARM_DQ and 108 ALARM_D, the operating system occupies temporarily system memory space. For example, if you do not delete a FB that exists in the CPU with SFC 107 or SFC 108 calls it may happen that corresponding system resources stay permanently occupied.

If you reload the FB with SFC 108 or SFC 108 calls, it may happen that the SFCs 107 and 108 are not processed properly anymore.

Description

With SFC 105 READ_SI you can read currently used system resources occupied with the SFCs 107 and 108 when messages were generated.

This is done via the values of *EV_ID* and *CMP_ID* used in this place. The values are passed on to SFC 105 READ_SI in parameter *SI_ID*.

SFC 105 READ_SI has four possible operating modes that we explain in the table below. Set the desired operating mode via the *MODE* parameter.

MODE	Which of the system resources occupied by SFC 107/SFC 108 are read?
1	All (call of SFC 105 with <i>SI_ID</i> : =0)
2	The system resource occupied by the call of SFC 107-/SFC 108 with <i>EV_ID</i> : = ev_id (call of the SFC 105 with <i>SI_ID</i> : = ev_id)

MODE	Which of the system resources occupied by SFC 107/SFC 108 are read?
3	The system resource occupied by the call of SFC 107-/SFC 108 with <i>CMP_ID</i> : = <i>cmp_id</i> (call of the SFC 105 with <i>SI_ID</i> : = <i>ev_id</i>)
0	Additional system resources that could not be read with the previous call in <i>MODE</i> =1 or <i>MODE</i> =3 because you have specified a target field <i>SYS_INST</i> that is too small.

Operating principle

If you have not selected a sufficiently large *SYS_INST* target area when you called the SFC 105 in *MODE* =1 or *MODE* =3, it contains the content of all currently occupied system resources selected via *MODE* parameter.

High system load on resources will cause a correspondingly high SFC runtime. That is, a high load on CPU performance may result in overshoot of the maximum configurable cycle monitoring time. You can work around this runtime problem as follows: Select a relatively small *SYS_INST* target area.

RET_VAL = 0001h informs you if the SFC cannot enter all system resources to be read in *SYS_INST*. In this case, call SFC 105 with *MODE* =0 and the same *SI_ID* as for the previous call until the value of *RET_VAL* is 0000h.



Since the operating system does not coordinate the SFC 105 calls that belong to the read job, you should execute all SFC 105 calls with the same priority class.

Target Area SYS_INST

The target area for the fetched occupied system resource must lie within a DB. You should appropriately define the target area as a field of structures, whereby a structure is constructed as follows:

Structure element	Data type	Description
SFC_NO	WORD	No. of the SFC that occupies the system resource
LEN	BYTE	Length of the structures in bytes, incl. <i>SFC_NO</i> and <i>LEN</i> : 0Ch
SIG_STAT	BOOL	Signal state
ACK_STAT	BOOL	Acknowledgement status of the incoming event (positive edge)
EV_ID	DWORD	Message number
CMP_ID	DWORD	Partial system ID

Parameters

Parameter	Declaration	Data type	Memory Area	Description
MODE	INPUT	INT	I, Q, M, D, L, constant	Job identifier Permissible values: <ul style="list-style-type: none"> ■ 1: Read all system resources ■ 2: Read the system resource that was occupied with <i>EV_ID</i> = <i>ev_id</i> when SFC 107-/SFC 108 was called ■ 3: Read the system resources that were occupied with <i>CMP_ID</i> = <i>cmp_id</i> when SFC 107-/SFC 108 was called ■ 0: subsequent call
SI_ID	INPUT	DWORD	I, Q, M, D, L, constant	ID for the system resource(s) to be read Permissible values <ul style="list-style-type: none"> ■ 0, if <i>MODE</i> = 1 ■ Message number <i>ev_id</i>, if <i>MODE</i> = 2 ■ ID <i>cmp_id</i> for identification of the system section, if <i>MODE</i> = 3
RET_VAL	OUTPUT	INT	I, Q, M, D, L,	Return value (error information or job status)
N_SI	OUTPUT	INT	I, Q, M, D, L,	Number of output system resources with <i>SYS_INT</i>
SYS_INST	OUTPUT	ANY	D	Target area for the fetched system resources.

RET_VAL (Return value)

Error code	Description
0000h	No error occurred.
0001h	Not all system resources could be read because the <i>SYS_INT</i> target range you have selected is too short.
8081h	(only with <i>MODE</i> =2 or 3) You have assigned the value 0 to <i>SI_ID</i> .
8082h	only with <i>MODE</i> =1) You have assigned one of 0 different values to <i>SI_ID</i> .
8083h	(only with <i>MODE</i> =0) You have assigned <i>SI_ID</i> a value other than at the preceding call of the SFC with <i>MODE</i> =1 or 3.
8084h	You have assigned an illegal value to <i>MODE</i> .
8085h	SFC 105 is already being processed in another OB.
8086h	Target area <i>SYS_INST</i> too small for a system resource.
8087h or 8092h	Target area <i>SYS_INST</i> does not exist in a DB or error in the ANY pointer.
8xyyh	General error information ↳ <i>Chap. 4.2 'General and Specific Error Information RET_VAL' page 66</i>

14.1.60 SFC 106 - DEL_SI - Reading Dynamic System Resources

Overview

When messages are generated with SFCs 107 ALARM_DQ and 108 ALARM_D, the operating system occupies temporarily system memory space.

For example, if you do not delete a FB that exists in the CPU with SFC 107 or SFC 108 calls it may happen that corresponding system resources stay permanently occupied. If you reload the FB with SFC 108 or SFC 108 calls, it may happen that the SFCs 107 and 108 are not processed properly anymore.

Description

With SFC 106 DEL_SI you can delete currently used system resources.

SFC 106 DEL_SI has three possible operating modes explained in the table below. Set the desired operating mode via the *MODE* parameter.

MODE	Which of the system resources occupied by SFC 107/SFC 108 are deleted?
1	All (call of SFC 106 with <i>SI_ID</i> : = 0)
2	The system resource occupied by the call of SFC 107-/SFC 108 with <i>EV_ID</i> : = ev_id (call of the SFC 106 with <i>SI_ID</i> : = ev_id)
3	The system resource occupied by the call of SFC 107-/SFC 108 with <i>CMP_ID</i> : = cmp_id (call of the SFC 106 with <i>SI_ID</i> : = e v_id)

Parameters

Parameter	Declaration	Data type	Memory Area	Description
MODE	INPUT	INT	I, Q, M, D, L, constant	Job identifier Permissible values <ul style="list-style-type: none"> ■ 1: delete all system resources ■ 2: delete the system resource that was occupied with <i>EV_ID</i> = ev_id when SFC 107-/SFC 108 was called ■ 3: delete the system resources that were occupied with <i>CMP_ID</i> = cmp_id when SFC 107-/SFC 108 was called
SI_ID	INPUT	DWORD	I, Q, M, D, L, constant	ID of the system resource(s) to be deleted Permissible values <ul style="list-style-type: none"> ■ 0, if <i>MODE</i> = 1 ■ Message number ev_id, if <i>MODE</i> = 2 ■ ID cmp_id for identification of the system section, if <i>MODE</i> = 3
RET_VAL	OUTPUT	INT	I, Q, M, D, L	Error Information

RET_VAL (Return value)

Error code	Description
0000h	No error occurred.
8081h	(only with <i>MODE</i> = 2 or 3) You have assigned the value 0 to <i>SI_ID</i> .
8082h	(only with <i>MODE</i> = 1) You have assigned one of 0 different values to <i>SI_ID</i> .
8084h	You have assigned an illegal value to <i>MODE</i> .
8085h	SFC 106 is currently being processed.
8086h	Not all selected system resources could be deleted because at least one of them was being processed when SFC 106 was called.
8xyyh	General error information ↳ <i>Chap. 4.2 'General and Specific Error Information RET_VAL' page 66</i>

14.1.61 SFC 107 - ALARM_DQ and SFC 108 - ALARM_D**Description**

With every call the SFCs 107 ALARM_DQ (Generating Acknowledgeable Block Related Messages) and 108 ALARM_D (Permanently Acknowledged Block Related Messages) generate a message to which you can append an associated value. Thus, you correspond with SFCs 17 ALARM_SQ and 18 ALARM_S.

When generating messages with SFCs 107 ALARM_DQ and 108 ALARM_D, the operating system temporarily occupies a system resource for the duration of the signal cycle.

The signal cycle time for SFC 108 ALARM_D starts at the SFC call with *SIG* = 1 and ends at a new call with *SIG* = 0. This interval for SFC 107 ALARM_DQ may be extended by the time expiring until the incoming signal is acknowledged at a logged in displaying device.

For SFC 108 ALARM_D, the signal cycle lasts from the SFC call *SIG* = 1 until another call with *SIG* = 0. For SFC 107 ALARM_DQ, this time period also includes the time until the incoming signal is acknowledged by one of the reported display devices, if necessary.

If, during the signal cycle, the message-generating block is overloaded or deleted, the associated system resource remains occupied until the next restart.

The additional functionality of SFCs 107 ALARM_DQ and 108 ALARM_D compared to SFCs 17 and 18 is now that you can manage these occupied system resources:

- With the help of SFC 105 READ_SI you can fetch information related to occupied system resources.
- With SFC 106 DEL_SI you can release occupied system resources again. This is of special significance for permanently occupied system resources. A currently occupied system resource, for example, stays occupied until the next restart if you, in the course of a program change, delete an FB call that contains SFC 107 or SFC 108 calls. When you change the program, and reload an FB with SFC 107 or SFC 108 calls, it may happen that the SFCs 107 and 108 do not generate anymore messages.

Description Parameter

The SFCs 107 and 108 contain one parameter more than the SFCs 17 and 18, namely the input *CMP_ID*. Use this input to assign the messages generated with SFCs 107 and 108 to logical areas, for example to parts of the system. If you call SFC 107/SFC 108 in an FB the obvious thing to do is to assign the number of the corresponding instance DB to *CMP_ID*.

Parameters

Parameter	Declaration	Data type	Memory block	Description
SIG	INPUT	BOOL	I, Q, M, D, L	The message triggering signal
ID	INPUT	WORD	I, Q, M, D, L, constant	Data channel for messages: EEEh
EV_ID	INPUT	DWORD	I, Q, M, D, L, constant	Message number (not allowed: 0)
CMP_ID	INPUT	DWORD	I, Q, M, D, L, constant	Component identifier (not allowed: 0) ID for the partial system to which the corresponding message is assigned Recommended values: <ul style="list-style-type: none"> ■ Low-Word: 1 ... 65535 ■ High-Word: 0 You will not be confronted with any conflicts if you are compliant with these recommendations.
SD	INPUT	ANY	I, Q, M, D, T, C	Associated value Maximum length: 12 bytes Permitted are only data of the type BOOL (not allowed: Bit field), BYTE, CHAR, WORD, INT, DWORD, DINT, REAL, DATE, TOD, TIME, S5TIME, DATE_AND_TIME
RET_VAL	OUTPUT	INT	I, Q, M, D, L	Error Information

RET_VAL (Return value)

Error code	Description
0000h	No error occurred.
0001h	<ul style="list-style-type: none"> ■ The length of the associated value exceeds the maximum permissible length, or ■ Access to user memory not possible (for example, access to deleted DB). The activated message is sent. ■ The associated value points to a value in the local data area. The message is sent. (S7-400 only)
0002h	Warning: The last free message acknowledge memory was occupied. (S7-400 only)
8081h	The specified <i>EV_ID</i> lies outside the valid range.
8082h	Message loss because your CPU has no more resource for generating block related messages with SFCs.
8083h	Message loss, the same signal transition is already present but could not be sent yet (signal overflow).
8084h	With the current and the previous SFC 107-/SFC-108 call the message triggering signal SIG has the same value.
8085h	There is no logon for the specified <i>EV_ID</i> .
8086h	An SFC call for the specified <i>EV_ID</i> is already being processed in a lower priority class.
8087h	At the initial call of SFC 107/SFC 108 the message triggering signal had the value 0.
8088h	The specified <i>EV_ID</i> is already in use by another system resource (to SFC 17, 18, 107, 108).

Error code	Description
8089h	You have assigned the value 0 to <i>CMP_ID</i> .
808Ah	<i>CMP_ID</i> not fit to <i>EV_ID</i>
8xyyh	General error information ↪ Chap. 4.2 'General and Specific Error Information RET_VAL' page 66

14.2 System Function Blocks

14.2.1 SFB 0 - CTU - Up-counter

Description

The SFB 0 can be used as Up-counter. Here you have the following characteristics:

- If the signal at the up counter input CU changes from "0" to "1" (positive edge), the current counter value is incremented by 1 and displayed at output CV.
- When called for the first time with R="0" the counter value corresponds to the preset value at input PV.
- When the upper limit of 32767 is reached the counter will not be incremented any further, i.e. all rising edges at input CU are ignored.
- The counter is reset to zero if reset input R has signal state "1".
- Output Q has signal state "1" if $CV \geq PV$.
- When it is necessary that the instances of this SFB are initialized after a restart, then the respective instances must be initialized in OB 100 with R = 1.

Parameters

Parameter	Declaration	Data type	Memory block	Description
CU	INPUT	BOOL	I, Q, M, D, L, constant	Count input
R	INPUT	BOOL	I, Q, M, D, L, constant	Reset input. <i>R</i> takes precedence over <i>CU</i> .
PV	INPUT	INT	I, Q, M, D, L, constant	Preset value
Q	OUTPUT	BOOL	I, Q, M, D, L	Status of the counter
CV	OUTPUT	INT	I, Q, M, D, L	Current count

CU

Count input:

This counter is incremented by 1 when a rising edge (with respect to the most recent SFB call) is applied to input CU.

R

Reset input:

The counter is reset to 0 when input R is set to "1", irrespective of the status of input CU.

PV

Preset value:

This value is the comparison value for the current counter value. Output Q indicates whether the current count is greater than or equal to the preset value PV.

Q Status of the counter:

- Q is set to "1" if $CV \geq PV$ (current count \geq preset value)
- else Q = "0"

CV Current count:

- possible values: 0 ... 32767

14.2.2 SFB 1 - CTD - Down-counter

Description

The SFB 1 can be used as Down-counter. Here you have the following characteristics:

- If the signal state at the down counter input *CD* changes from "0" to "1" (positive edge), the current counter value is decremented by 1 and displayed at output *CV*.
- When called for the first time with *LOAD* = "0" the counter value corresponds to the preset value at input *PV*.
- When the lower limit of -32767 is reached the counter will not be decremented any further, i.e. all rising edges at input *CU* are ignored.
- When a "1" is applied to the *LOAD* input then the counter is set to preset value *PV* irrespective of the value applied to input *CD*.
- Output *Q* has signal state "1" if $CV \leq 0$.
- When it is necessary that the instances of this SFB are initialized after a restart, then the respective instances must be initialized in OB 100 with *LOAD* = 1 and *PV* = required preset value for *CV*.

Parameters

Parameter	Declaration	Data type	Memory block	Description
CD	INPUT	BOOL	I, Q, M, D, L, constant	Count input
LOAD	INPUT	BOOL	I, Q, M, D, L, constant	Load input. <i>LOAD</i> takes precedence over <i>CD</i> .
PV	INPUT	INT	I, Q, M, D, L, constant	Preset value
Q	OUTPUT	BOOL	I, Q, M, D, L	Status of the counter
CV	OUTPUT	INT	I, Q, M, D, L	Current count

CD Count input:
This counter is decremented by 1 when a rising edge (with respect to the most recent SFB call) is applied to input *CU*.

LOAD Load input:
When a 1 is applied to the *LOAD* input then the counter is set to preset value *PV* irrespective of the value applied to input *CD*.

PV Preset value:
The counter is set to preset value *PV* when the input *LOAD* is "1".

Q	Status of the counter: <ul style="list-style-type: none">■ "1", if $CV \leq 0$■ else $Q = "0"$
CV	Current count: <ul style="list-style-type: none">■ possible values: -32 768 ... 32 767

14.2.3 SFB 2 - CTUD - Up-Down counter

Description

The SFB 2 can be used as an Up-Down counter. Here you have the following characteristics:

- If the signal state at the up count input *CU* changes from "0" to "1" (positive edge), the counter value is incremented by 1 and displayed at output *CV*.
- If the signal state at the down count input *CD* changes from "0" to "1" (positive edge), the counter value is decremented by 1 and displayed at output *CV*.
- If both counter inputs have a positive edge, the current counter value does not change.
- When the count reaches the upper limit of 32767 any further edges are ignored.
- When the count reaches the lower limit of -32768 any further edges are ignored.
- When a "1" is applied to the *LOAD* input then the counter is set to preset value *PV*.
- The counter value is reset to zero if reset input *R* has signal state "1". Positive signal edges at the counter inputs and signal state "1" at the load input remain without effect while input *R* has signal state "1".
- Output *QU* has signal state "1", if $CV \geq PV$.
- Output *QD* has signal state "1", if $CV \leq 0$.
- When it is necessary that the instances of this SFB are initialized after a restart, then the respective instances must be initialized in OB 100 with:
 - when the counter is used as up-counter with $R = "1"$
 - when the counter is used as down-counter with $R = 0$ and $LOAD = 1$ and $PV =$ preset value.

Parameters

Parameter	Declaration	Data type	Memory block	Description
CU	INPUT	BOOL	I, Q, M, D, L, constant	Count up input
CD	INPUT	BOOL	I, Q, M, D, L, constant	Count down input
R	INPUT	BOOL	I, Q, M, D, L, constant	Reset input, <i>R</i> takes precedence over <i>LOAD</i> .
LOAD	INPUT	BOOL	I, Q, M, D, L, constant	Load input, <i>LOAD</i> takes precedence over <i>CU</i> and <i>CD</i> .
PV	INPUT	INT	I, Q, M, D, L, constant	Preset value
QU	OUTPUT	BOOL	I, Q, M, D, L,	Status of the up counter
QD	OUTPUT	BOOL	I, Q, M, D, L,	Status of the down counter
CV	OUTPUT	INT	I, Q, M, D, L,	Current count

- CU** Count up input:
A rising edge (with respect to the most recent SFB-call) at input *CU* increments the counter.
- CD** Count down input:
A rising edge (with respect to the most recent SFB-call) at input *CD* decrements the counter.
- R** Reset input:
When input *R* is set to "1" the counter is reset to 0, irrespective of the status of inputs *CU*, *CD* and *LOAD*.
- LOAD** Load input:
When the *LOAD* input is set to "1" the counter is preset to the value applied to *PV*, irrespective of the values of inputs *CU* and *CD*.
- PV** Preset value:
The counter is preset to the value applied to *PV*, when the *LOAD* input is set to 1.
- QU** Status of the up counter:
 - $QU = "1"$ if $CV \geq PV$ (Current count \geq Preset value)
 - else $QU = "0"$
- QD** Status of the down counter:

- QD is set to "1", if $0 \geq CV$ (Current count smaller/= 0)
- else $QU = "0"$

CV Current count

- possible values: -32 768 ... 32 767

14.2.4 SFB 3 - TP - Create pulse

Description

The SFB 3 can be used to generate a pulse with a pulse duration equal to PT . Here you have the following characteristics:

- The pulse duration is only available in the STARTUP and RUN modes.
- The pulse is started with a rising edge at input IN .
- During PT time the output Q is set regardless of the input signal.
- The ET output provides the time for which output Q has already been set. The maximum value of the ET output is the value of the PT input. Output ET is reset when input IN changes to "0", however, not before the time PT has expired.
- When it is necessary that the instances of this SFB 3 are initialized after a restart, then the respective instances must be initialized in OB 100 with $PT = 0$ ms.

Time diagram

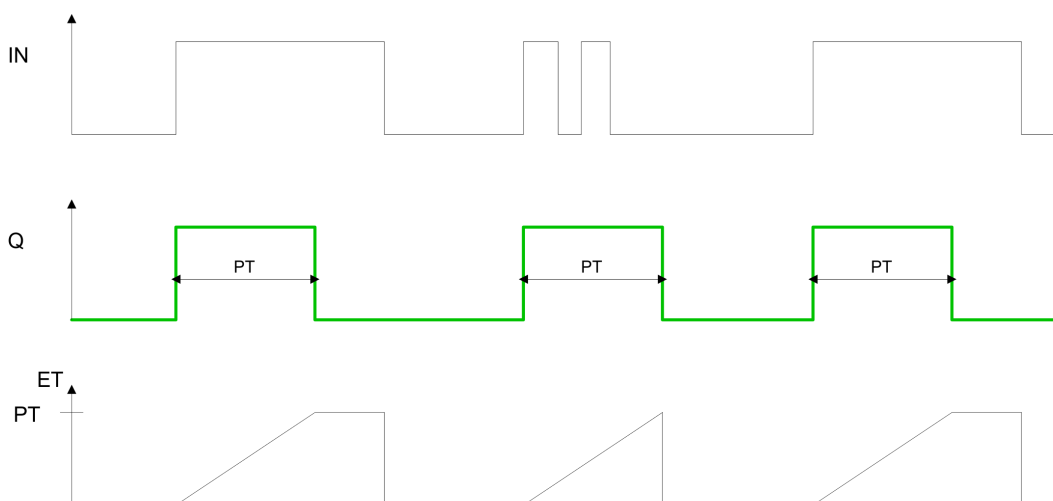

Parameters

Parameter	Declaration	Data type	Memory block	Description
IN	INPUT	BOOL	I, Q, M, D, L, constant	Start input
PT	INPUT	TIME	I, Q, M, D, L, constant	Pulse duration
Q	OUTPUT	BOOL	I, Q, M, D, L,	Status of the time
ET	OUTPUT	TIME	I, Q, M, D, L,	Expired time

IN Start input:
The pulse is started by a rising edge at input IN .

PT Pulse duration:

PT must be positive. The range of these values is determined by data type TIME.

Q	Output Q: Output Q remains active for the pulse duration PT , irrespective of the subsequent status of the input signal
ET	Expired time: The duration for which output Q has already been active is available at output ET where the maximum value of this output can be equal to the value of PT . When input IN changes to 0 output ET is reset, however, this only occurs after PT has expired.

14.2.5 SFB 4 - TON - Create turn-on delay

Description

SFB 4 can be used to delay a rising edge by period PT . Here you have the following characteristics:

- The timer runs only in the STARTUP and RUN modes.
- A rising edge at the IN input causes a rising edge at output Q after the time PT has expired. Q then remains set until the IN input changes to 0 again. If the IN input changes to "0" before the time PT has expired, output Q remains set to "0".
- The ET output provides the time that has passed since the last rising edge at the IN input. Its maximum value is the value of the PT input. ET is reset when the IN input changes to "0".
- When it is necessary that the instances of this SFB are initialized after a restart, then the respective instances must be initialized in OB 100 with $PT = 0$ ms.

Timing diagram

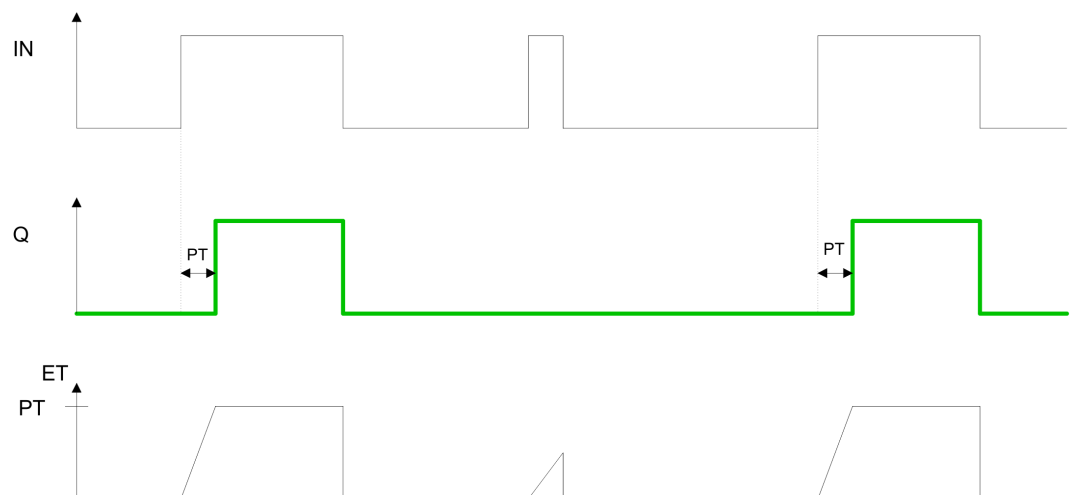

Parameters

Parameter	Declaration	Type	Memory block	Description
IN	INPUT	BOOL	I, Q, M, D, L, constant	Start input
PT	INPUT	TIME	I, Q, M, D, L, constant	Time delay
Q	OUTPUT	BOOL	I, Q, M, D, L	Status of time
ET	OUTPUT	TIME	I, Q, M, D, L	Expired time

IN	Start input: The time delay is started by a rising edge at input <i>IN</i> . Output <i>Q</i> also produces a rising edge when time delay <i>PT</i> has expired.
PT	Time delay: Time delay applied to the rising edge at input <i>IN</i> to <i>PT</i> must be. The range of values is defined by the data type <i>TIME</i> .
Q	Output <i>Q</i> : The time delay is started by a rising edge at input <i>IN</i> . Output <i>Q</i> also produces a rising edge when time delay <i>PT</i> has expired and it remains set until the level applied to input <i>IN</i> changes back to 0. If input <i>IN</i> changes to 0 before time delay <i>PT</i> has expired then output <i>Q</i> remains at "0".
ET	Expired time: Output <i>ET</i> is set to the time duration that has expired since the most recent rising edge has been applied to input <i>IN</i> . The highest value that output <i>ET</i> can contain is the value of input <i>PT</i> . Output <i>ET</i> is reset when input <i>IN</i> changes to "0".

14.2.6 SFB 5 - TOF - Create turn-off delay

Description	<p>SFB 5 can be used to delay a falling edge by period <i>PT</i>. Here you have the following characteristics:</p> <ul style="list-style-type: none"> ■ The timer runs only in the STARTUP and RUN modes. ■ A rising edge at the <i>IN</i> input causes a rising edge at output <i>Q</i>. A falling edge at the <i>IN</i> input causes a falling edge at output <i>Q</i> delayed by the time <i>PT</i>. If the <i>IN</i> input changes back to "1" before the time <i>PT</i> has expired, output <i>Q</i> remains set to "1". ■ The <i>ET</i> output provides the time that has elapsed since the last falling edge at the <i>IN</i> input. Its maximum value is, however the value of the <i>PT</i> input. <i>ET</i> is reset when the <i>IN</i> input changes to "1". ■ When it is necessary that the instances of this SFB are initialized after a restart, then the respective instances must be initialized in OB 100 with <i>PT</i> = 0 ms.
--------------------	---

Time diagram

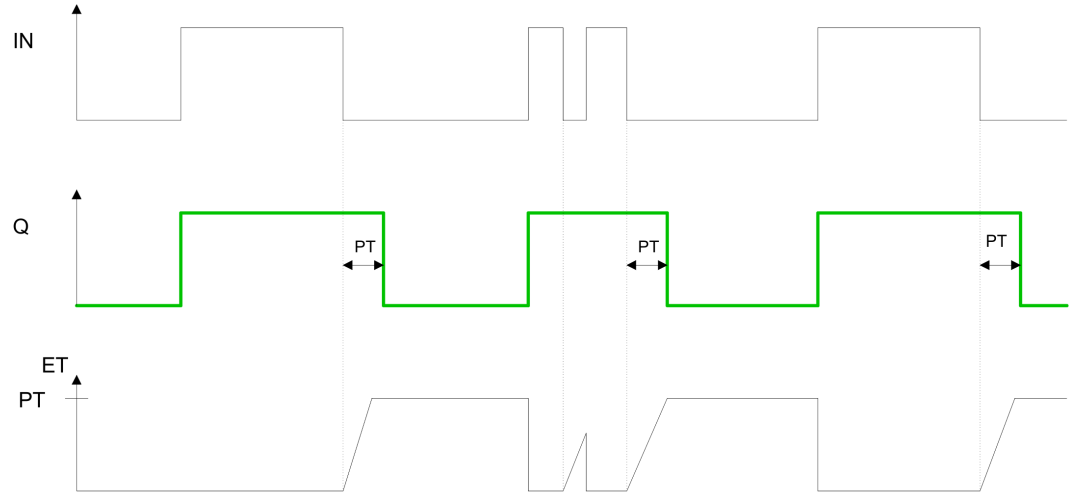

Parameters

Parameter	Declaration	Data type	Memory block	Description
IN	INPUT	BOOL	I, Q, M, D, L, constant	Start input
PT	INPUT	TIME	I, Q, M, D, L, constant	Time delay
Q	OUTPUT	BOOL	I, Q, M, D, L	Status of time
ET	OUTPUT	TIME	I, Q, M, D, L	Expired time

- IN** Start input:
 The time delay is started by a rising edge at input *IN* results in a rising edge at output *Q*. When a falling edge is applied to input *IN* output *Q* will also produce a falling edge when delay *PT* has expired. If the level at input *IN* changes to "1" before time delay *PT* has expired, then the level at output *Q* will remain at "1".
- PT** Time delay:
 Time delay applied to the falling edge at input *IN* to *PT* must be. The range of values is defined by the data type TIME.
- Q** Output *Q*:
 The time delay is started by a rising edge at input *IN* results in a rising edge at output *Q*. When a falling edge is applied to input *IN* output *Q* will also produce a falling edge when delay *PT* has expired. If the level at input *IN* changes to "1" before time delay *PT* has expired, then the level at output *Q* will remain at "1".
- ET** Expired time:
 The time period that has expired since the most recent falling edge at input *IN* is available from output *ET*. The highest value that output *ET* can reach is the value of input *PT*. Output *ET* is reset when the level at input *IN* changes to "1".

14.2.7 FB/SFB 12 - BSEND - Sending data in blocks

Description

FB/SFB 12 BSEND sends data to a remote partner FB/SFB of the type BRCV (FB/SFB 13). The data area to be transmitted is segmented. Each segment is sent individually to the partner. The last segment is acknowledged by the partner as it is received, independently of the calling up of the corresponding FB/SFB/BRCV. With this type of data transfer, more data can be transported between the communications partners than is possible with all other communication FBs/SFBs for configured S7 connections, namely 65534 bytes.



Please note that this block calls the FC or SFC 202 AG_BSEND internally. These must not be overwritten! The direct call of an internal block leads to errors in the corresponding instance DB!

Depending upon communication function the following behavior is present:

- **Siemens S7-300 Communication (FB 12)**
 - The send job is activated on a rising edge at *REQ*. The parameters *R_ID*, *ID*, *SD_1* and *LEN* are transferred on each positive edge at *REQ*. After a job has been completed, you can assign new values to the *R_ID*, *ID*, *SD_1* and *LEN* parameters. For the transmission of segmented data the block must be called periodically in the user program. The start address and the maximum length of the data to be sent are specified by *SD_1*. You can determine the job-specific length of the data field with *LEN*.
- **Siemens S7-400 Communication (SFB 12)**
 - The send job is activated after calling the block and when there is a rising edge at *REQ*. Sending the data from the user memory is carried out asynchronously to the processing of the user program. The start address and the maximum length of the data to be sent are specified by *SD_1*. You can determine the job-specific length of the data field with *LEN*. In this case, *LEN* replaces the length section of *SD_1*.

Function

- If there is a rising edge at control input *R*, the current data transfer is cancelled.
- Successful completion of the transfer is indicated by the status parameter *DONE* having the value 1.
- A new send job cannot be processed until the previous send process has been completed if the status parameter *DONE* or *ERROR* have the value 1.
- Due to the asynchronous data transmission, a new transmission can only be initiated if the previous data have been retrieved by the call of the partner FB/SFB. Until the data are retrieved, the status value 7 will be given when the FB/SFB BSEND is called.



*The parameter *R_ID* must be identical at the two corresponding FBs/SFBs.*

Parameters

Parameter	Declaration	Data type	Memory block	Description
REQ	INPUT	BOOL	I, Q, M, D, L	Control parameter request, a rising edge activates the data exchange (with respect to the most recent FB/SFB call)
R	INPUT	BOOL	I, Q, M, D, L, constant	control parameter reset: terminates the active task

Parameter	Declaration	Data type	Memory block	Description
ID	INPUT	WORD	I, Q, M, D, constant	A reference for the connection. Format W#16#xxxx
R_ID	INPUT	DWORD	I, Q, M, D, L, constant	Address parameter <i>R_ID</i> . Format DW#16#wxyzWXYZ.
DONE	OUTPUT	BOOL	I, Q, M, D, L	Status parameter <i>DONE</i> : 0: task has not been started or is still being executed. 1: task was executed without error.
ERROR	OUTPUT	BOOL	I, Q, M, D, L	Status parameter <i>ERROR</i> : <ul style="list-style-type: none"> ■ <i>ERROR</i> = 0 + <i>STATUS</i> = 0000h <ul style="list-style-type: none"> – No warnings or errors. ■ <i>ERROR</i> = 0 + <i>STATUS</i> unequal to 0000h <ul style="list-style-type: none"> – A Warning has occurred. <i>STATUS</i> contains detailed information. ■ <i>ERROR</i> = 1 <ul style="list-style-type: none"> – An error has occurred.
STATUS	OUTPUT	WORD	I, Q, M, D, L	Status parameter <i>STATUS</i> , returns detailed information about the type of error.
SD_1	IN_OUT	ANY	I, Q, M, D, T, C	Pointer to the send data buffer. The length parameter is only utilized when the block is called for the first time after a start. It specifies the maximum length of the send buffer. Only data type BOOL is valid (Bit field not permitted), BYTE, CHAR, WORD, INT, DWORD, DINT, REAL, DATE, TOD, TIME, S5TIME, DATE_AND_TIME, COUNTER, TIMER.
LEN	IN_OUT	WORD	I, Q, M, D, L	The length of the send data block in bytes.

Error information

ERROR	STATUS (decimal)	Description
0	11	Warning: the new task is not active since the previous task has not completed.
0	25	The communication process was initiated. The task is being processed.
1	1	Communication failures, e.g.: <ul style="list-style-type: none"> ■ Connection parameters not loaded (local or remote) ■ Connection interrupted (e.g. cable, CPU turned off, CP in STOP)
1	2	Negative acknowledgment received from the partner FB/SFB. The function cannot be executed.
1	3	<i>R_ID</i> is not available to the communication link specified by ID or the receive block has never been called.
1	4	Error in send buffer pointer <i>SD_1</i> with respect to the length or the data type, or parameter <i>LEN</i> was set to 0 or an error has occurred in the receive data buffer pointer <i>RD_1</i> of the respective FB/SFB 13 BRCV

ERROR	STATUS (decimal)	Description
1	5	Reset request was executed.
1	6	The status of the partner FB/SFB is DISABLED (<i>EN_R</i> has a value of 0)
1	7	The status of the partner FB/SFB is not correct (the receive block has not been called after the most recent data transfer).
1	8	Access to the remote object in application memory was rejected.
1	10	Access to local application memory not possible (e.g. access to deleted DB).
1	12	The call to the FB/SFB <ul style="list-style-type: none"> ■ contains an instance DB that does not belong to the FB/SFB 12 ■ contains a global DB instead of an instance DB ■ could not locate an instance DB (load a new instance DB from the PG)
1	18	<i>R_ID</i> already exists in the connection ID.
1	20	Not enough memory.

Data consistency

To guarantee consistent data the segment of send buffer *SD_1* that is currently being used can only be overwritten when current send process has been completed. For this purpose the program can test parameter *DONE*.

14.2.8 FB/SFB 13 - BRCV - Receiving data in blocks

Description

The FB/SFB 13 BRCV can receive data from a remote partner FB/SFB of the type BSEND (FB/SFB 12). The parameter *R_ID* of both FB/SFBs must be identical. After each received data segment an acknowledgment is sent to the partner FB/SFB and the *LEN* parameter is updated.



Please note that this block calls the FC or SFC 203 AG_BRCV internally. These must not be overwritten! The direct call of an internal block leads to errors in the corresponding instance DB!

Depending upon communication function the following behavior is present:

- **Siemens S7-300 Communication (FB 13)**
 - The parameters *R_ID*, *ID* and *RD_1* are applied with every positive edge on *EN_R*. After a job has been completed, you can assign new values to the *R_ID*, *ID* and *RD_1* parameters. For the transmission of segmented data the block must be called periodically in the user program.
- **Siemens S7-400 Communication (SFB 13)**
 - Receipt of the data from the user memory is carried out asynchronously to the processing of the user program.

Parameters

Parameter	Declaration	Data type	Memory block	Description
EN_R	INPUT	BOOL	I, Q, M, D, L, constant	control parameter enabled to receive, indicates that the partner is ready for reception
ID	INPUT	WORD	I, Q, M, D, constant	A reference for the connection. Format: W#16#xxxx
R_ID	INPUT	DWORD	I, Q, M, D, L, constant	Address parameter <i>R_ID</i> . Format: DW#16#wxyzWXYZ
NDR	OUTPUT	BOOL	I, Q, M, D, L	Status parameter NDR: new data accepted.
ERROR	OUTPUT	BOOL	I, Q, M, D, L	Status parameter <i>ERROR</i> : <ul style="list-style-type: none"> ■ <i>ERROR</i> = 0 + <i>STATUS</i> = 0000h <ul style="list-style-type: none"> – No warnings or errors. ■ <i>ERROR</i> = 0 + <i>STATUS</i> unequal to 0000h <ul style="list-style-type: none"> – A Warning has occurred. <i>STATUS</i> contains detailed information. ■ <i>ERROR</i> = 1 <ul style="list-style-type: none"> – An error has occurred.
STATUS	OUTPUT	WORD	I, Q, M, D, T, C	Status parameter <i>STATUS</i> , returns detailed information about the type of error.
RD_1	IN_OUT	ANY	I, Q, M, D, T, C	Pointer to the receive data buffer. The length specifies the maximum length for the block that must be received. Only data type BOOL is valid (Bit field not permitted), BYTE, CHAR, WORD, INT, DWORD, DINT, REAL, DATE, TOD, TIME, S5TIME, DATE_AND_TIME, COUNTER, TIMER.
LEN	IN_OUT	WORD	I, Q, M, D, L	Length of the data that has already been received.

Function

- The FB/SFB 13 is ready for reception when control input *EN_R* is set to 1. Parameter *RD_1* specifies the start address of the receive data buffer. An acknowledgment is returned to the partner FB/SFB after reception of each data segment and parameter *LEN* of the FB/SFB 13 is updated accordingly. If the block is called during the asynchronous reception process a warning is issued via the status parameter *STATUS*.
- Should this call be received with control input *EN_R* set to 0 then the receive process is terminated and the FB/SFB is reset to its initial state. When all data segments have been received without error parameter *NDR* is set to 1. The received data remains unaltered until FB/SFB 13 is called again with parameter *EN_R* = 1.

Error information

ERROR	STATUS (decimal)	Description
0	11	Warning: the new task is not active since the previous task has not completed.
0	17	Warning: block is receiving asynchronous data.
0	25	Communications has been initiated. The task is being processed.
1	1	Communication failures, e.g. <ul style="list-style-type: none"> ■ Connection parameters not loaded (local or remote) ■ Connection interrupted (e.g. cable, CPU turned off, CP in STOP)
1	2	Function cannot be executed.
1	4	Error in the receive data block pointer <i>RD_1</i> with respect to the length or the data type (the send data block is larger than the receive data block).
1	5	Reset request received, incomplete data transfer.
1	8	Access to the remote object in application memory was rejected.
1	10	Access to local application memory not possible (e.g. access to deleted DB).
1	12	The call to the FB/SFB <ul style="list-style-type: none"> ■ contains an instance DB that does not belong to the FB/SFB 13 ■ contains a global DB instead of an instance DB ■ could not locate an instance DB (load a new instance DB from the PG)
1	18	<i>R_ID</i> already exists in the connection <i>ID</i> .
1	20	Not enough memory.

Data consistency

To guarantee data consistency during reception the following points must be met:

- When copying has been completed (parameter *NDR* is set to 1) FB/SFB 13 must again be called with parameter *EN_R* set to 0 in order to ensure that the receive data block is not overwritten before it has been evaluated.
- The most recently used receive data block *RD_1* must have been evaluated completely before the block is denoted as being ready to receive (calls with parameter *EN_R* set to 1).

Receiving Data S7-400

- If a receiving CPU with a BRCV block ready to accept data (that is, a call with *EN_R* = 1 has already been made) goes into STOP mode before the corresponding send block has sent the first data segment for the job, the following will occur:
- The data in the first job after the receiving CPU has gone into STOP mode are fully entered in the receive area.
- The partner SFB BSEND receives a positive acknowledgment.
- Any additional BSEND jobs can no longer be accepted by a receiving CPU in STOP mode.
- As long as the CPU remains in STOP mode, both *NDR* and *LEN* have the value 0.
- To prevent information about the received data from being lost, you must perform a hot restart of the receiving CPU and call SFB 13 BRCV with *EN_R* = 1.

14.2.9 FB/SFB 14 - GET - Remote CPU read

Description

The FB/SFB 14 GET can be used to read data from a remote CPU. The respective CPU must be in RUN mode or in STOP mode.



Please note that this block calls the FC or SFC 200 AG_GET internally. These must not be overwritten! The direct call of an internal block leads to errors in the corresponding instance DB!

Depending upon communication function the following behavior is present:

- *Siemens S7-300 Communication (FB 14)*
 - The data is read on a rising edge at *REQ*. The parameters *ID*, *ADDR_1* and *RD_1* are transferred on each rising edge at *REQ*. After a job has been completed, you can assign new values to the *ID*, *ADDR_1* and *RD_1* parameters.
- *Siemens S7-400 Communication (SFB 14)*
 - The SFB is started with a rising edge at *REQ*. In the process the relevant pointers to the areas to be read out (*ADDR_i*) are sent to the partner CPU.

Parameters

Parameter	Declaration	Data type	Memory block	Description
REQ	INPUT	BOOL	I, Q, M, D, L	control parameter request, a rising edge activates the data exchange (with respect to the most recent FB/SFB-call)
ID	INPUT	WORD	I, Q, M, D, constant	A reference for the connection. Format: W#16#xxxx
NDR	OUTPUT	BOOL	I, Q, M, D, L	Status parameter <i>NDR</i> : data from partner CPU has been accepted.
ERROR	OUTPUT	BOOL	I, Q, M, D, L	Status parameter <i>ERROR</i> : <ul style="list-style-type: none"> ■ <i>ERROR</i> = 0 + <i>STATUS</i> = 0000h <ul style="list-style-type: none"> – No warnings or errors. ■ <i>ERROR</i> = 0 + <i>STATUS</i> unequal to 0000h <ul style="list-style-type: none"> – A Warning has occurred. <i>STATUS</i> contains detailed information. ■ <i>ERROR</i> = 1 <ul style="list-style-type: none"> – An error has occurred.

Parameter	Declaration	Data type	Memory block	Description
STATUS	OUTPUT	WORD	I, Q, M, D, L	Status parameter <i>STATUS</i> , returns detailed information about the type of error.
ADDR_1	IN_OUT	ANY	e.g. I, Q, M, D	Pointer indicating the buffers in the partner CPU that must be read
ADDR_2	IN_OUT	ANY	e.g. I, Q, M, D	Pointer indicating the buffers in the partner CPU that must be read
ADDR_3	IN_OUT	ANY	e.g. I, Q, M, D	Pointer indicating the buffers in the partner CPU that must be read
ADDR_4	IN_OUT	ANY	e.g. I, Q, M, D	Pointer indicating the buffers in the partner CPU that must be read
RD_i, 1 ≤ i ≤ 4	IN_OUT	ANY	I, Q, M, D, T, C	Pointers to the area of the local CPU in which the read data are entered. Only data type BOOL is valid (bit field not permitted), BYTE, CHAR, WORD, INT, DWORD, DINT, REAL, DATE, TOD, TIME, S5TIME, DATE_AND_TIME, COUNTER, TIMER.

Function

- The remote CPU returns the data and the answer is checked for access problems during the read process for the data. The data type is checked in addition.
- When a data transfer error is detected the received data are copied into the configured receive data buffer (*RD_i*) with the next call to FB/SFB 14 and parameter *NDR* is set to 1.
- It is only possible to activate a new read process when the previous read process has been completed. You must ensure that the defined parameters on the *ADDR_i* and *RD_i* areas and the number that fit in quantity, length and data type of data to each other.

Error information

ERROR	STATUS (decimal)	Description
0	11	Warning: the new task is not active since the previous task has not completed.
0	25	The communication process was initiated. The task is being processed.
1	1	Communication failures, e.g. <ul style="list-style-type: none"> ■ Connection parameters not loaded (local or remote) ■ Connection interrupted (e.g.: cable, CPU turned off, CP in STOP)
1	2	Negative acknowledgment from partner device. The function cannot be executed.
1	4	Error in receive data buffer pointer <i>RD_i</i> with respect to the length or the data type.
1	8	Partner CPU access error
1	10	Access to local application memory not possible (e.g. access to deleted DB).

ERROR	STATUS (decimal)	Description
1	12	The call to the FB/SFB <ul style="list-style-type: none"> ■ contains an instance DB that does not belong to the FB/SFB 14 ■ contains a global DB instead of an instance DB ■ could not locate an instance DB (load a new instance DB from the PG)
1	20	Not enough memory.

Data consistency

The data are received consistently if you evaluate the current use of range *RD_i* completely before initiating another job.

14.2.10 FB/SFB 15 - PUT - Remote CPU write

Description

The FB/SFB 15 PUT can be used to write data to a remote CPU. The respective CPU may be in RUN mode or in STOP mode.



Please note that this block calls the FC or SFC 201 AG_PUT internally. These must not be overwritten! The direct call of an internal block leads to errors in the corresponding instance DB!

Depending upon communication function the following behavior is present:

- **Siemens S7-300 Communication (FB 15)**
 - The data is sent on a rising edge at *REQ*. The parameters *ID*, *ADDR_1* and *SD_1* are transferred on each rising edge at *REQ*. After a job has been completed, you can assign new values to the *ID*, *ADDR_1* and *SD_1* parameters.
- **Siemens S7-400 Communication (SFB 15)**
 - The SFB is started on a rising edge at *REQ*. In the process the pointers to the areas to be written (*ADDR_i*) and the data (*SD_i*) are sent to the partner CPU.

Parameters

Parameter	Declaration	Data type	Memory block	Description
REQ	INPUT	BOOL	I, Q, M, D, L	control parameter request, a rising edge activates the data exchange (with respect to the most recent FB/SFB-call)
ID	INPUT	WORD	I, Q, M, D, constant	A reference for the connection. Format <i>W#16#xxxx</i>
DONE	OUTPUT	BOOL	I, Q, M, D, L	Status parameter <i>DONE</i> : function completed.

Parameter	Declaration	Data type	Memory block	Description
ERROR	OUTPUT	BOOL	I, Q, M, D, L	Status parameter <i>ERROR</i> : <ul style="list-style-type: none"> ■ <i>ERROR</i> = 0 + <i>STATUS</i> = 0000h <ul style="list-style-type: none"> – No warnings or errors. ■ <i>ERROR</i> = 0 + <i>STATUS</i> unequal to 0000h <ul style="list-style-type: none"> – A Warning has occurred. <i>STATUS</i> contains detailed information. ■ <i>ERROR</i> = 1 <ul style="list-style-type: none"> – An error has occurred.
STATUS	OUTPUT	WORD	I, Q, M, D, L	Status parameter <i>STATUS</i> , returns detailed information about the type of error.
ADDR_1	IN_OUT	ANY	e.g. I, Q, M, D	Pointer indicating the buffers in the partner CPU into which data is written
ADDR_2	IN_OUT	ANY	e.g. I, Q, M, D	Pointer indicating the buffers in the partner CPU into which data is written
ADDR_3	IN_OUT	ANY	e.g. I, Q, M, D	Pointer indicating the buffers in the partner CPU into which data is written
ADDR_4	IN_OUT	ANY	e.g. I, Q, M, D	Pointer indicating the buffers in the partner CPU into which data is written
SD_i, 1 ≤ i ≤ 4	IN_OUT	ANY	I, Q, M, D, T, C	Pointer to the data buffers in the local CPU that contains the data that must be sent. Only data type BOOL is valid (Bit field not permitted), BYTE, CHAR, WORD, INT, DWORD, DINT, REAL, DATE, TOD, TIME, S5TIME, DATE_AND_TIME, COUNTER, TIMER.

Function

- The partner CPU stores the data at the respective address and returns an acknowledgment.
- This acknowledgment is tested and when an error is detected in the data transfer parameter *DONE* is set to 1 with the next call of FB/SFB 15.
- The write process can only be activated again when the most recent write process has been completed. The amount, length and data type of the buffer areas that were defined by means of parameters *ADDR_i* and *SD_i*, $1 \leq i \leq 4$ must be identical.

Error information

ERROR	STATUS (decimal)	Description
0	11	Warning: the new task is not active since the previous task has not completed.
0	25	The communication process was initiated. The task is being processed.
1	1	Communication failures, e.g. <ul style="list-style-type: none"> ■ Connection parameters not loaded (local or remote) ■ Connection interrupted (e.g.: cable, CPU turned off, CP in STOP)
1	2	Negative acknowledgment from partner device. The function cannot be executed.

ERROR	STATUS (decimal)	Description
1	4	Error in transmission range pointers SD_i with respect to the length or the data type
1	8	Partner CPU access error
1	10	Access to local application memory not possible (e.g. access to deleted DB).
1	12	The call to the FB/SFB contains an instance DB that does not belong to the FB/SFB 15. contains a global DB instead of an instance DB. could not locate an instance DB (load a new instance DB from the PG).
1	20	Not enough memory.

Data consistency

- *Siemens S7-300 Communication*
 - In order to ensure data consistency, send area SD_1 may not be used again for writing until the current send process has been completed. This is the case when the state parameter *DONE* has the value "1".
- *Siemens S7-400 Communication*
 - When a send operation is activated (rising edge at *REQ*) the data to be sent from the send area SD_i are copied from the user program. After the block call, you can write to these areas without corrupting the current send data.

14.2.11 SFB 31 - NOTIFY_8P - Messages without acknowledge display (8x)**Description**

Generating block related messages without acknowledgement display for 8 signals.

- SFB 31 NOTIFY_8P represents an extension of SFB 36 "NOTIFY" to 8 signals.
- A message is generated if at least one signal transition has been detected. A message is always generated at the initial call of SFB 31. All 8 signal are allocated a common message number that is split into 8 sub-messages on the displaying device.
- One memory with 2 memory blocks is available for each instance of SFB 31 NOTIFY_8P.
- The displaying device shows the last two signal transitions, irrespective of message loss.



Before you call SFB 31 NOTIFY_8P in a automation system, you must insure that all connected displaying devices know this block. More information about this may be found in the manuals of the components used.

Parameter

Parameter	Declaration	Data type	Memory block	Description
SIG_i,	INPUT	BOOL	I, Q, M, D, L	i-th signal to be monitored
ID	INPUT	WORD	Constant (I, Q, M, D, L)	Data channel for messages: EEEEh. ID is only evaluated at the first call.
EV_ID	INPUT	DWORD	Constant (I, Q, M, D, L)	Message number (not permitted: 0)
SEVERITY	INPUT	WORD	Constant (I, Q, M, D, L)	Weighting of the event
DONE	OUTPUT	BOOL	I, Q, M, D, L	Status parameter DONE: Message generation completed.
ERROR	OUTPUT	BOOL	I, Q, M, D, L	Status parameter ERROR
STATUS	OUTPUT	WORD	I, Q, M, D, L	Status parameter STATUS: Display of an error information
SD_i	IN_OUT	ANY	I, Q, M, D, T, C	i-th associated value

SIG_i, i-th signal to be monitored It is valid $1 \leq i \leq 8$.

ID Data channel for messages: EEEEEh. *ID* is only evaluated at the first call.

EV_ID EV_ID is only evaluated at the first call. Subsequently, the message number used for the first call applies to every call of SFB with the corresponding instance DB. The message number is automatically assigned by the Siemens STEP®7 programming tool. So the consistency of the message numbers is guaranteed. The message numbers within a user program must be unique.

SEVERITY Weighting of the event Here the value 0 is the highest weighting. This parameter is irrelevant for processing the message. Possible values: 0 ... 127 (default value: 64)

DONE Status parameter *DONE*, Message generation completed.

SD_i i-th associated value It is valid $1 \leq i \leq \text{maxNumber}$. The max. number of associated values may be found in the technical data of your CPU. Permitted are only data of the type BOOL, (not permitted: bit field), BYTE, CHAR, WORD, INT, DWORD, DINT, REAL, DATE, TOD, TIME, S5TIME, DATE_AND_TIME.



When the ANY pointer accesses a DB, the DB always must be specified (e.g.: P# DB10.DBX5.0 Byte 10).

Error information ERROR / STATUS *ERROR* = TRUE indicates that an error has occurred during processing. For details refer to parameter *STATUS*. The following table contains all the error information specific to SFB 31 that can be output with the *ERROR* and *STATUS* parameters.

ERROR	STATUS (decimal)	Description
0	11	Message lost: The previous signal change or the previous message could not be sent and will be replaced by the current message.
0	22	<ul style="list-style-type: none"> ■ Error in the pointer to the associated values <i>SD_i</i>: <ul style="list-style-type: none"> – relating to the data length or the data type – Associated values in the user memory not accessible, for example, due to deleted DB or area length error. The activated message is sent without associated values or if necessary with even possible number of associated values. ■ The actual parameter you have selected for <i>SEVERITY</i> is higher than the permitted range. The activated message is sent with <i>SEVERITY</i> = 127.
0	25	Communication was initiated. The message is being processed.
1	1	Communication problems: Disconnection or no logon
1	4	At the first call the specified <i>EV_ID</i> is outside the permitted range or the ANY pointer <i>SD_i</i> has a formal error or the maximum memory area that can be sent for the CPU per SFB 31 was exceeded.
1	10	Access to local user memory not possible (for example, access to a deleted DB)
1	12	When the SFB was called: an instance DB that does not belong to SFB 31 was specified or a shared DB instead of an instance DB was specified.
1	18	<i>EV_ID</i> was already being used by one of the SFBs 31 or 33 ... 36.
1	20	Not enough working memory.
1	21	The message with the specified <i>EV_ID</i> is disabled.

14.2.12 SFB 32 - DRUM - Realize a step-by-step switch

Description

Implementing a 16-state cycle switch using the SFB 32.

- Parameter *DSP* defines the number of the first step, parameter *LST_STEP* defines the number of the last step.
- Every step describes the 16 output bits *OUT0 ... OUT15* and output parameter *OUT_WORD* that summarizes the output bits.
- The cycle switch changes to the next step when a positive edge occurs at input *JOG* with respect to the previous SFB-call. If the cycle switch has already reached the last step and a positive edge is applied to *JOG* variables *Q* and *EOD* will be set, *DCC* is set to 0 and SFB 32 remains at the last step until a "1" is applied to the *RESET* input.

Time controlled switching

The switch can also be controlled by a timer. For this purpose parameter *DRUM_EN* must be set to "1".

- The next step of the cycle switch is activated when:
 - the event bit *EVENTi* of the current step is set and
 - when the time defined for the current step has expired.
- The time is calculated as the product of time base *DTBP* and the timing factor that applies to the current step (from the *S_PRESET* field).

- If input *RESET* is set to "1" when the call is issued to SFB 32 then the cycle switch changes to the step that you have specified as a number at input *DSP*.
- When this module is called for the first time the *RESET* input must be set to "1".
- If the cycle switch has reached the last step and the processing time defined for this step has expired, then outputs *Q* and *EOD* will be set and SFB 32 will remain at the last step until the *RESET* input is set to "1".
- The SFB 32 is only active in operating modes STARTUP and RUN.
- If SFB 32 must be initialized after a restart it must be called from OB 100 with *RESET* = "1".



The remaining processing time DCC in the current step will only be decremented if the respective event bit EVENTi is set.



Special conditions apply if parameter DRUM_EN is set to "1":

- *timer-controlled cycle switching, if EVENTi = "1" with DSP = I = LST_STEP.*
- *event-controlled cycle switching by means of event bits EVENTi, when DTBP = "0".*

In addition it is possible to advance the cycle switch at any time (even if DRUM_EN = "1") by means of the JOG input.

Parameters

Parameter	Declaration	Data type	Memory block	Description
RESET	INPUT	BOOL	I, Q, M, D, L, constant	Reset
JOG	INPUT	BOOL	I, Q, M, D, L, constant	Switch to the next stage
DRUM_EN	INPUT	BOOL	I, Q, M, D, L, constant	Control parameter
LST_STEP	INPUT	BYTE	I, Q, M, D, L, constant	Number of the last step
EVENTi, 1 ≤ i ≤ 16	INPUT	BOOL	I, Q, M, D, L, constant	Event bit No. i (belongs to step i)
OUTj, 0 ≤ j ≤ 15	OUTPUT	BOOL	I, Q, M, D, L	Output bit No. j
Q	OUTPUT	BOOL	I, Q, M, D, L	Status parameter
OUT_WORD	OUTPUT	WORD	I, Q, M, D, L, P	Output bits
ERR_CODE	OUTPUT	WORD	I, Q, M, D, L, P	<i>ERR_CODE</i> contains the error information if an error occurs when the SFB is being processed

Parameter	Declaration	Data type	Memory block	Description
JOG_HIS	VAR	BOOL	I, Q, M, D, L, constant	Not relevant to the user
EOD	VAR	BOOL	I, Q, M, D, L, constant	Identical with output parameter Q
DSP	VAR	BYTE	I, Q, M, D, L, P constant	Number of the first step
DSC	VAR	BYTE	I, Q, M, D, L, P constant	Number of the current step
DCC	VAR	DWORD	I, Q, M, D, L, P constant	The remaining processing time for the current step in ms
DTBP	VAR	WORD	I, Q, M, D, L, P constant	The time base in ms that applies to all steps
PREV_TIME	VAR	DWORD	I, Q, M, D, L, constant	Not relevant to the user
S_PRESET	VAR	ARRAY of WORD	I, Q, M, D, L, constant	One dimensional field containing the timing factors for every step
OUT_VAL	VAR	ARRAY of BOOL	I, Q, M, D, L, constant	Two-dimensional field containing the output values for every step
S_MASK	VAR	ARRAY of BOOL	I, Q, M, D, L, constant	Two-dimensional field containing the mask bits for every step.

RESET

Reset:

- The cycle switch is reset if this is set to "1".
- *RESET* must be set to "1" when the initial call is issued to the block.

JOG

A rising edge (with respect to the last SFB call) increments the cycle switch to the next stage if the cycle switch has not yet reached the last step. This is independent of the value of *DRUM_EN*.

DRUM_EN

Control parameter that determines whether timer-controlled cycle switching to the next step should be enabled or not

("1": enable timer-controlled increments).

LST_STEP

Number of the last step:

- possible values: 1 ... 16

EVENTi, 1≤i≤16

Event bit No. i (belonging to step i)

OUT_j, 0 ≤ j ≤ 15	Output bit No. j (identical with bit No. j of <i>OUT_WORD</i>)
Q	Status parameter specifying whether the processing time that you have defined for the last step has expired.
OUT_WORD	Output bits summarized in a single variable.
ERR_CODE	<i>ERR_CODE</i> contains the error information if an error occurs when the SFB is being processed. ↪ 'Error information' page 752
JOG_HIS	Not relevant to the user: input parameter <i>JOG</i> of the previous SFB-call.
EOD	Identical with output parameter <i>Q</i>
DSP	Number of the first step: <ul style="list-style-type: none"> ■ possible values 1 ... 16
DSC	Number of the current step
DCC	The remaining processing time for the current step in ms (only relevant if <i>DRUM_EN</i> = "1" and if the respective event bit = "1")
DTBP	The time base in ms that applies to all steps.
PREV_TIME	Not relevant to the user: system time of the previous SFB call.
S_PRESET	One-dimensional field containing the timing factors for every step. <ul style="list-style-type: none"> ■ Meaningful indices are: [1 ... 16]. In this case <i>S_PRESET</i> [x] contains the timing factor of step x.
OUT_VAL	Two-dimensional field containing the output values for every step if you have not masked these by means of <i>S_MASK</i> . <ul style="list-style-type: none"> ■ Meaningful indices are: [1 ... 16, 0 ... 15]. In this case <i>OUT_VAL</i> [x, y] contains the value that is assigned to output bit <i>OUT_y</i> in step x.
S_MASK	Two-dimensional field containing the mask bits for every step. <ul style="list-style-type: none"> ■ Meaningful indices are: [1 ... 16, 0 ... 15]. In this case <i>S_MASK</i> [x, y] contains the mask bit for the value y of step x. ■ Significance of the mask bits: <ul style="list-style-type: none"> – 0: the respective value of the previous step is assigned to the output bit – 1: the respective value of <i>OUT_VAL</i> is assigned to the output bit.

Error information

ERR_CODE

- When an error occurs the status of SFB 32 remains at the current value and output *ERR_CODE* contains one of the following error codes:

ERR_CODE	Description
0000h	No error has occurred
8081h	illegal value for <i>LST_STEP</i>
8082h	illegal value for <i>DSC</i>
8083h	illegal value for <i>DSP</i>
8084h	The product $DCC = DTBP \times S_PRESET$ [DSC] exceeds the value 2^{31-1} (appr. 24.86 days)

14.2.13 SFB 33 - ALARM - Messages with acknowledgement display

Description

Generating block-related messages with acknowledgement display:

- SFB 33 ALARM monitors a signal:
 - Acknowledgement triggered reporting is disabled (default): The block generates a message both on a rising edge (event entering state) and on a falling edge (event leaving state) to which associated values can be added.
 - Acknowledgement triggered reporting is enabled: After an incoming message is generated for the signal, the block will no longer generate messages until you have acknowledged this incoming message on a displaying device.
- When the SFB is first called, a message with the current signal state is sent. The message is sent to all stations logged on for this purpose.
- Once your acknowledgement has been received from a logged on display device, the acknowledgement information is passed on to all other stations logged on for this purpose.
- One message memory with 2 memory blocks is available for each instance of SFB 33 ALARM.
- SFB 33 ALARM complies with the IEC 1131-5 standard.

Parameter

Parameter	Declaration	Data type	Memory block	Description
EN_R	INPUT	BOOL	I, Q, M, D, L	Control parameter
SIG	INPUT	BOOL	I, Q, M, D, L	The signal to be monitored.
ID	INPUT	WORD	Constant (I, Q, M, D, L)	Data channel for messages: EEEEh. <i>ID</i> is only evaluated at the first call.
EV_ID	INPUT	DWORD	Constant (I, Q, M, D, L)	Message number (not allowed: 0)
SEVERITY	INPUT	WORD	Constant (I, Q, M, D, L)	Weighting of the event
DONE	OUTPUT	BOOL	I, Q, M, D, L	Status parameter <i>DONE</i> : Message generation completed.
ERROR	OUTPUT	BOOL	I, Q, M, D, L	<i>ERROR</i> status parameter

Parameter	Declaration	Data type	Memory block	Description
STATUS	OUTPUT	WORD	I, Q, M, D, L	<i>STATUS</i> parameter: Display of an error information
ACK_DN	OUTPUT	BOOL	I, Q, M, D, L	Outgoing event was acknowledged
ACK_UP	OUTPUT	BOOL	I, Q, M, D, L	Incoming event was acknowledged.
SD_i	IN_OUT	ANY	I, Q, M, D, T, C	i-th associated value

EN_R	Control parameter (enabled to receive) that decides whether the outputs <i>ACK_UP</i> and <i>ACK_DN</i> are updated at the first block call ($EN_R = 1$) or not ($EN_R = 0$). If $EN_R = 0$ the output parameters <i>ACK_UP</i> and <i>ACK_DN</i> remain unchanged.
SIG	The signal to be monitored.
ID	Data channel for messages: <i>EEEEh</i> . <i>ID</i> is only evaluated at the first call.
EV_ID	<i>EV_ID</i> is only evaluated at the first call. Subsequently, the message number used for the first call applies to every call of SFB with the corresponding instance DB. The message number is automatically assigned by the Siemens STEP®7 programming tool. So the consistency of the message numbers is guaranteed. The message numbers within a user program must be unique.
SEVERITY	Weighting of the event Here the value 0 is the highest weighting. This parameter is irrelevant for processing the message. Possible values: 0 ... 127 (default value: 64)
DONE	Status parameter <i>DONE</i> , Message generation completed.
ACK_DN	Outgoing event has been acknowledged on a display device. Initialization status: 1. The <i>ACK_DN</i> output is reset at the negative edge. It is set when your acknowledgement of the event leaving the state is received from a logged on display device.
ACK_UP	Incoming event has been acknowledged on a display device. Initialization status: 1 The <i>ACK_UP</i> output is reset at the rising edge. It is set when your acknowledgement of the event entering the state has arrived from a logged on display device.
SD_i	i-th associated value It is valid $1 \leq i \leq \text{maxNumber}$. The max. number of associated values may be found in the technical data of your CPU. Permitted are only data of the type BOOL, (not permitted: bit field), BYTE, CHAR, WORD, INT, DWORD, DINT, REAL, DATE, TOD, TIME, S5TIME, DATE_AND _TIME.



When the ANY pointer accesses a DB, the DB always must be specified.
(e.g.: P# DB10.DBX5.0 Byte 10).

Error information *ERROR* / *STATUS* *ERROR* = TRUE indicates that an error has occurred during processing. For details refer to parameter *STATUS*. The following table contains all the error information specific to SFB 33 that can be output with the *ERROR* and *STATUS* parameters.

<i>ERROR</i>	<i>STATUS</i> (decimal)	Description
0	11	Message lost: The previous signal change or the previous message could not be sent and will be replaced by the current message.
0	22	<ul style="list-style-type: none"> ■ Error in the pointer to the associated values <i>SD_i</i>: <ul style="list-style-type: none"> – relating to the data length or the data type – Associated values in the user memory not accessible, for example, due to deleted DB or area length error. The activated message is sent without associated values or if necessary with even possible number of associated values. ■ The actual parameter you have selected for <i>SEVERITY</i> is higher than the permitted range. The activated message is sent with <i>SEVERITY</i> = 127.
0	25	Communication was initiated. The message is being processed.
1	1	Communication problems: Disconnection or no logon With acknowledgement-triggered reporting active: temporary display, if no display devices support acknowledgement-triggered reporting.
1	4	At the first call the specified <i>EV_ID</i> is outside the permitted range or the ANY pointer <i>SD_i</i> has a formal error or the maximum memory area that can be sent for the CPU per SFB 31 was exceeded.
1	10	Access to local user memory not possible (for example, access to a deleted DB)
1	12	When the SFB was called: an instance DB that does not belong to SFB 31 was specified or a shared DB instead of an instance DB was specified.
1	18	<i>EV_ID</i> was already being used by one of the SFBs 31 or 33 ... 36.
1	20	Not enough working memory.
1	21	The message with the specified <i>EV_ID</i> is disabled.



*After the first block call, the *ACK_UP* and *ACK_DN* outputs have the value 1 and it is assumed that the previous value of the *SIG* input was 0.*

14.2.14 SFB 34 - ALARM_8 - Messages without associated values (8x)

Description

Generating block-related messages without associated values for 8 signals.

- SFB 34 ALARM_8 is identical to SFB 35 ALARM_8P.
- Except the associated values are not transferred.

Parameter

Parameter	Declaration	Data type	Memory block	Description
EN_R	INPUT	BOOL	I, Q, M, D, L Constant	Control parameter
SIG_i	INPUT	BOOL	I, Q, M, D, L	i-th signal to be monitored
ID	INPUT	WORD	Constant (I, Q, M, D, L)	Data channel for messages: EEEEh. <i>ID</i> is only evaluated at the first call.
EV_ID	INPUT	DWORD	Constant (I, Q, M, D, L)	Message number (not allowed: 0)
SEVERITY	INPUT	WORD	Constant (I, Q, M, D, L)	Weighting of the event
DONE	OUTPUT	BOOL	I, Q, M, D, L	Status parameter <i>DONE</i> : Message generation completed.
ERROR	OUTPUT	BOOL	I, Q, M, D, L	Status parameter <i>ERROR</i>
STATUS	OUTPUT	WORD	I, Q, M, D, L	Status parameter <i>STATUS</i> : Display of an error information
ACK_STATE	OUTPUT	WORD	I, Q, M, D, L	Bit field acknowledgement status of all 8 messages

EN_R	Control parameter (enabled to receive) that decides whether the output <i>ACK_STATE</i> is updated (<i>EN_R</i> = 1) when the block is called or not (<i>EN_R</i> = 0).
SIG_i	i-th signal to be monitored It is valid $1 \leq i \leq 8$.
ID	Data channel for messages: EEEEh. <i>ID</i> is only evaluated at the first call.
EV_ID	<i>EV_ID</i> is only evaluated at the first call. Subsequently, the message number used for the first call applies to every call of SFB with the corresponding instance DB. The message number is automatically assigned by the Siemens STEP®7 programming tool. So the consistency of the message numbers is guaranteed. The message numbers within a user program must be unique.
SEVERITY	Weighting of the event Here the value 0 is the highest weighting. This parameter is irrelevant for processing the message. Possible values: 0 ... 127 (default value: 64)
DONE	Status parameter <i>DONE</i> : Message generation completed.
ACK_STATE	Bit field with the current acknowledgement status of all 8 messages. <ul style="list-style-type: none"> ■ Bit 7 ... 0: incoming event of SIG_1 ... SIG_8 ■ Bit 15 ... 8: outgoing event of SIG_1 ... SIG_8 (1: Event acknowledged, 0: Event not acknowledged): Initialization status: FFFFh, this means, all incoming and outgoing events have been acknowledged.

Error information *ERROR* / *STATUS* *ERROR* = TRUE indicates that an error has occurred during processing. For details refer to parameter *STATUS*. The following table contains all the error information specific to SFB 34 that can be output with the *ERROR* and *STATUS* parameters.

<i>ERROR</i>	<i>STATUS</i> (decimal)	Description
0	11	Message lost: The previous signal change or the previous message could not be sent and will be replaced by the current message.
0	22	The actual parameter you have selected for <i>SEVERITY</i> is higher than the permitted range. The activated message is sent with <i>SEVERITY</i> = 127.
0	25	Communication was initiated. The message is being processed.
1	1	Communication problems: Communications problems: connection abort or no logon With acknowledgement-triggered reporting active: temporary display, if no display devices support acknowledgement-triggered reporting.
1	4	At the first call, the specified <i>EV_ID</i> is outside the permitted range.
1	10	Access to local user memory not possible (for example, access to a deleted DB)
1	12	When the SFB was called: an instance DB that does not belong to SFB 34 was specified or a shared DB instead of an instance DB was specified.
1	18	<i>EV_ID</i> was already being used by one of the SFBs 31 or 33 ... 36.
1	20	Not enough working memory.
1	21	The message with the specified <i>EV_ID</i> is disabled.



*After the first block call, all the bits of the *ACK_STATE* output are set and it is assumed that the previous values of inputs *SIG_i*, $1 \leq i \leq 8$ were 0.*

14.2.15 SFB 35 - ALARM_8P - Messages with associated values (8x)

Description

Generating block-related messages with associated values for 8 signals.

- SFB 35 ALARM_8P represents a linear extension of SFB 33 ALARM to 8 signals.
- As long as you have not enabled acknowledgement triggered reporting, a message will always be generated when a signal transition is detected at one or more signals (exception: a message is always sent at the first block call). All 8 signal are allocated a common message number that is split into 8 sub-messages on the displaying device. You can acknowledge each individual message separately or a group of messages.
- You can use the *ACK_STATE* output parameter to process the acknowledgement state of the individual messages in your program. If you disable or enable a message of an ALARM_8P block, this always affects the entire ALARM_8P block. Disabling and enabling of individual signals is not possible.
- One message memory with 2 memory blocks is available for each instance of SFB35 ALARM_8P.

Parameter

Parameter	Declaration	Data type	Memory block	Description
EN_R	INPUT	BOOL	I, Q, M, D, L	Control parameter
SIG_i,	INPUT	BOOL	I, Q, M, D, L	i-th signal to be monitored
ID	INPUT	WORD	Constant (I, Q, M, D, L)	Data channel for messages: EEEHh. ID is only evaluated at the first call.
EV_ID	INPUT	DWORD	Constant (I, Q, M, D, L)	Message number (not allowed: 0)
SEVERITY	INPUT	WORD	Constant (I, Q, M, D, L)	Weighting of the event
DONE	OUTPUT	BOOL	I, Q, M, D, L	Status parameter <i>DONE</i> : Message generation completed.
ERROR	OUTPUT	BOOL	I, Q, M, D, L	<i>ERROR</i> status parameter
STATUS	OUTPUT	WORD	I, Q, M, D, L	Status parameter <i>STATUS</i> : Display of an error information
ACK_STATE	OUTPUT	WORD	I, Q, M, D, L	Bit field acknowledgement status of all 8 messages
SD_j	IN_OUT	ANY	I, Q, M, D, T, C	j-th associated value

EN_R	Control parameter (enabled to receive) that decides whether the output <i>ACK_STATE</i> is updated ($EN_R = 1$) when the block is called or not ($EN_R = 0$).
SIG_i	i-th signal to be monitored It is valid $1 \leq i \leq 8$.
ID	Data channel for messages: EEEHh. ID is only evaluated at the first call.
EV_ID	EV_ID is only evaluated at the first call. Subsequently, the message number used for the first call applies to every call of SFB with the corresponding instance DB. The message number is automatically assigned by the Siemens STEP®7 programming tool. So the consistency of the message numbers is guaranteed. The message numbers within a user program must be unique.
SEVERITY	Weighting of the event Here the value 0 is the highest weighting. This parameter is irrelevant for processing the message. Possible values: 0 ... 127 (default value: 64)
DONE	Status parameter <i>DONE</i> , Message generation completed.
ACK_STATE	Bit field with the current acknowledgement status of all 8 messages. <ul style="list-style-type: none"> ■ Bit 7 ... 0: incoming event of SIG_1 ... SIG_8 ■ Bit 15 ... 8: outgoing event of SIG_1 ... SIG_8 1 Event acknowledged, 0: Event not acknowledged): Initialization status: FFFFh, this means, all incoming and outgoing events have been acknowledged.

SD_i i-th associated value It is valid $1 \leq i \leq \text{maxNumber}$. The max. number of associated values may be found in the technical data of your CPU. Permitted are only data of the type BOOL, (not permitted: bit field), BYTE, CHAR, WORD, INT, DWORD, DINT, REAL, DATE, TOD, TIME, S5TIME, DATE_AND_TIME.



When the ANY pointer accesses a DB, the DB always must be specified. (e.g.: P# DB10.DBX5.0 Byte 10).

Error information ERROR / STATUS *ERROR = TRUE* indicates that an error has occurred during processing. For details refer to parameter *STATUS*. The following table contains all the error information specific to SFB 35 that can be output with the *ERROR* and *STATUS* parameters.

ERROR	STATUS (decimal)	Description
0	11	Message lost: The previous signal change or the previous message could not be sent and will be replaced by the current message.
0	22	<ul style="list-style-type: none"> ■ Error in the pointer to the associated values SD_i: <ul style="list-style-type: none"> – relating to the data length or the data type – No access to associated values in user memory, for example, due to deleted DB or area length error. The activated message is sent without associated values. ■ The actual parameter you have selected for SEVERITY is higher than the permitted range. The activated message is sent with SEVERITY = 127.
0	25	Communication was initiated. The message is being processed.
1	1	Communication problems: Disconnection or no logon With acknowledgement-triggered reporting active: temporary display, if no display devices support acknowledgement-triggered reporting.
1	4	At the first call the specified EV_ID is outside the permitted range or the ANY pointer SD_i has a formal error or the maximum memory area that can be sent for the CPU per SFB 35 was exceeded.
1	10	Access to local user memory not possible (for example, access to a deleted DB)
1	12	When the SFB was called: an instance DB that does not belong to SFB 34 was specified or a shared DB instead of an instance DB was specified.
1	18	EV_ID was already being used by one of the SFBs 31 or 33 ... 36.
1	20	Not enough working memory.
1	21	The message with the specified EV_ID is disabled.



After the first block call. all the bits of the ACK_STATE output are set and it is assumed that the previous values of inputs SIG_i, 1 ≤ i ≤ 8 were 0.

14.2.16 SFB 36 - NOTIFY - Messages without acknowledgement display

Description

Generating block-related messages without acknowledgement display.

- SFB 36 NOTIFY monitors a signal. It generates a message both on a rising edge (event entering state) and on a falling edge (event leaving state) with associated values.
- When the SFB is first called, a message with the current signal state is sent. The message is sent to all stations logged on for this purpose.
- The associated values are queried when the edge is detected and assigned to the message.

Parameter

Parameter	Declaration	Data type	Memory block	Description
SIG	INPUT	BOOL	I, Q, M, D, L	The signal to be monitored.
ID	INPUT	WORD	Constant (I, Q, M, D, L)	Data channel for messages: EEEh. <i>ID</i> is only evaluated at the first call.
EV_ID	INPUT	DWORD	Constant (I, Q, M, D, L)	Message number (not allowed: 0)
SEVERITY	INPUT	WORD	Constant (I, Q, M, D, L)	Weighting of the event
DONE	OUTPUT	BOOL	I, Q, M, D, L	Status parameter <i>DONE</i> : Message generation completed.
ERROR	OUTPUT	BOOL	I, Q, M, D, L	<i>ERROR</i> status parameter
STATUS	OUTPUT	WORD	I, Q, M, D, L	<i>STATUS</i> parameter: Display of an error information
SD_i	IN_OUT	ANY	I, Q, M, D, T, C	i-th associated value

SIG The signal to be monitored.

ID Data channel for messages: EEEh. *ID* is only evaluated at the first call.

EV_ID *EV_ID* is only evaluated at the first call. Subsequently, the message number used for the first call applies to every call of SFB with the corresponding instance DB. The message number is automatically assigned by the Siemens STEP®7 programming tool. So the consistency of the message numbers is guaranteed. The message numbers within a user program must be unique.

SEVERITY Weighting of the event Here the value 0 is the highest weighting. This parameter is irrelevant for processing the message. Possible values: 0 ... 127 (default value: 64)

DONE Status parameter *DONE*: Message generation completed.

SD_i i-th associated value It is valid $1 \leq i \leq \text{maxNumber}$. The max. number of associated values may be found in the technical data of your CPU. Permitted are only data of the type BOOL, (not permitted: bit field), BYTE, CHAR, WORD, INT, DWORD, DINT, REAL, DATE, TOD, TIME, S5TIME, DATE_AND_TIME.



When the ANY pointer accesses a DB, the DB always must be specified. (e.g.: P# DB10.DBX5.0 Byte 10).

Error information ERROR / STATUS The following table contains all the error information specific to SFB 36 that can be output with the *ERROR* and *STATUS* parameters.

ERROR	STATUS (decimal)	Description
0	11	Message lost: The previous signal change or the previous message could not be sent and will be replaced by the current message.
0	22	<ul style="list-style-type: none"> ■ Error in the pointer to the associated values SD_i: <ul style="list-style-type: none"> – relating to the data length or the data type – Associated values in the user memory not accessible, for example, due to deleted DB or area length error. The activated message is sent without associated values or if necessary with even possible number of associated values. ■ The actual parameter you have selected for SEVERITY is higher than the permitted range. The activated message is sent with SEVERITY = 127.
0	25	Communication was initiated. The message is being processed.
1	1	Communication problems: Disconnection or no logon
1	4	At the first call the specified EV_ID is outside the permitted range or the ANY pointer SD_i has a formal error or the maximum memory area that can be sent for the CPU per SFB 36 was exceeded.
1	10	Access to local user memory not possible (for example, access to a deleted DB)
1	12	When the SFB was called: an instance DB that does not belong to SFB 36 was specified or a shared DB instead of an instance DB was specified.
1	18	EV_ID was already being used by one of the SFBs 31 or 33 ... 36.
1	20	Not enough working memory.
1	21	The message with the specified EV_ID is disabled.

14.2.17 SFB 47 - COUNT - Counter controlling

Description The SFB 47 is a specially developed block for compact CPUs for controlling of the counters. The SFB is to be called with the corresponding instance DB. Here the parameters of the SFB are stored. With the SFB COUNT (SFB 47) you have following functional options:

- Start/Stop the counter via software gate SW_GATE
- Enable/control digital output DO
- Read the status bit

- Read the actual count and latch value
- Request to read/write internal counter registers

Parameters

Name	Data type	Address (Instance DB)	Default value	Comment
LADDR	WORD	0.0	300h	This parameter is not evaluated. Always the internal I/O periphery is addressed.
CHANNEL	INT	2.0	0	Channel number
SW_GATE	BOOL	4.0	FALSE	Enables the Software gate
CTRL_DO	BOOL	4.1	FALSE	Enables the output False: Standard Digital Output
SET_DO	BOOL	4.2	FALSE	Parameter is not evaluated
JOB_REQ	BOOL	4.3	FALSE	Initiates the job (edge 0-1)
JOB_ID	WORD	6.0	0	Job ID
JOB_VAL	DINT	8.0	0	Value for write jobs
STS_GATE	BOOL	12.0	FALSE	Status of the internal gate
STS_STRT	BOOL	12.1	FALSE	Status of the hardware gate
STS_LTCH	BOOL	12.2	FALSE	Status of the latch input
STS_DO	BOOL	12.3	FALSE	Status of the output
STS_C_DN	BOOL	12.4	FALSE	Status of the down-count Always indicates the last direction of count. After the first SFB call <i>STS_C_DN</i> is set FALSE.
STS_C_UP	BOOL	12.5	FALSE	Status of the up-count Always indicates the last direction of count. After the first SFB call <i>STS_C_UP</i> is set TRUE.
COUNTVAL	DINT	14.0	0	Actual count value
LATCHVAL	DINT	18.0	0	Actual latch value
JOB_DONE	BOOL	22.0	TRUE	New job can be started
JOB_ERR	BOOL	22.1	FALSE	Job error
JOB_STAT	WORD	24.0	0	Job error ID

Local data only in instance DB

Name	Data type	Address (Instance DB)	Default value	Comment
RES00	BOOL	26.0	FALSE	reserved
RES01	BOOL	26.1	FALSE	reserved
RES02	BOOL	26.2	FALSE	reserved
STS_CMP	BOOL	26.3	FALSE	Comparator Status * Status bit <i>STS_CMP</i> indicates that the comparison condition of the comparator is or was reached. <i>STS_CMP</i> also indicates that the output was set. (<i>STS_DO</i> = TRUE).
RES04	BOOL	26.4	FALSE	reserved
STS_OFLW	BOOL	26.5	FALSE	Overflow status *
STS_UFLW	BOOL	26.6	FALSE	Underflow status *
STS_ZP	BOOL	26.7	FALSE	Status of the zero mark * The bit is only set when counting without main direction. Indicates the zero mark. This is also set when the counter is set to 0 or if it starts counting.
JOB_OVAL	DINT	28.0		Output value for read request.
RES10	BOOL	32.0	FALSE	reserved
RES11	BOOL	32.1	FALSE	reserved
RES_STS	BOOL	32.2	FALSE	Reset status bits: Resets the status bits: <i>STS_CMP</i> , <i>STS_OFLW</i> , <i>STS_ZP</i> . The SFB must be twice called to reset the status bit.

*) Reset with RES_STS



Per channel you may call the SFB in each case with the same instance DB, since the data necessary for the internal operational are stored here. Writing accesses to outputs of the instance DB is not permissible.

Counter request interface

To read/write counter registers the request interface of the SFB 47 may be used. So that a new job may be executed, the previous job must have been finished with *JOB_DONE* = TRUE.

Proceeding

The deployment of the request interface takes place at the following sequence:

1. Edit the following input parameters:

Name	Data type	Address (DB)	Default	Comment
JOB_REQ	BOOL	4.3	FALSE	Initiates the job (edges 0-1) *
JOB_ID	WORD	6.0	0	Job ID: 00h Job without function 01h Writes the <i>count value</i> 02h Writes the <i>load value</i> 04h Writes the <i>comparison value</i> 08h Writes the <i>hysteresis</i> 10h Writes the <i>pulse duration</i> 20h Writes the <i>end value</i> 82h Reads the <i>load value</i> 84h Reads the <i>comparison value</i> 88h Reads the <i>hysteresis</i> 90h Reads the <i>pulse duration</i> A0h Reads the <i>end value</i>
JOB_VAL	DINT	8.0	0	Value for write jobs

*) State remains set also after a CPU STOP-RUN transition.

2. Call the SFB. The job is processed immediately. *JOB_DONE* only applies to SFB run with the result FALSE. *JOB_ERR* = TRUE if an error occurred. Details on the error cause are indicated at *JOB_STAT*.

Name	Data type	Address (DB)	Default	Comment
JOB_DONE	BOOL	22.0	TRUE	New job can be started
JOB_ERR	BOOL	22.1	FALSE	Job error
JOB_STAT	WORD	24.0	0000h	Job error ID 0000h No error 0121h <i>Comparison value</i> too low 0122h <i>Comparison value</i> too high 0131h <i>Hysteresis</i> too low 0132h <i>Hysteresis</i> too high 0141h <i>Pulse duration</i> too low 0142h <i>Pulse duration</i> too high 0151h <i>Load value</i> too low 0152h <i>Load value</i> too high 0161h <i>Count value</i> too low 0162h <i>Count value</i> too high 01FFh Invalid <i>job ID</i>

3. A new job may be started with *JOB_DONE* = TRUE.

4. → A value to be read of a read job may be found in *JOB_OVAL* in the instance DB at address 28.

Permitted value range for JOB_VAL

Continuous count:

Job	Valid range
Writing <i>counter</i> directly	-2147483647 ($-2^{31}+1$) ... +2147483646 ($2^{31}-2$)
Writing the <i>load value</i>	-2147483647 ($-2^{31}+1$) ... +2147483646 ($2^{31}-2$)
Writing <i>comparison value</i>	-2147483648 (-2^{31}) ... +2147483647 ($2^{31}-1$)
Writing <i>hysteresis</i>	0 ... 255
Writing <i>pulse duration*</i>	0 ... 510ms

Single/periodic count, no main count direction:

Job	Valid range
Writing <i>counter</i> directly	-2147483647 ($-2^{31}+1$) ... +2147483646 ($2^{31}-2$)
Writing the <i>load value</i>	-2147483647 ($-2^{31}+1$) ... +2147483646 ($2^{31}-2$)
Writing <i>comparison value</i>	-2147483648 (-2^{31}) ... +2147483647 ($2^{31}-1$)
Writing <i>hysteresis</i>	0 ... 255
Writing <i>pulse duration*</i>	0 ... 510ms

Single/periodic count, main count direction up:

Job	Valid range
<i>End value</i>	2 ... +2147483646 ($2^{31}-1$)
Writing <i>counter</i> directly	-2147483648 (-2^{31}) ... <i>end value</i> -2
Writing the <i>load value</i>	-2147483648 (-2^{31}) ... <i>end value</i> -2
Writing <i>comparison value</i>	-2147483648 (-2^{31}) ... <i>end value</i> -1
Writing <i>hysteresis</i>	0 ... 255
Writing <i>pulse duration*</i>	0 ... 510ms

Single/periodic count, main count direction down:

Job	Valid range
Writing <i>counter</i> directly	2 ... +2147483647 ($2^{31}-1$)
Writing the <i>load value</i>	2 ... +2147483647 ($2^{31}-1$)
Writing <i>comparison value</i>	1 ... +2147483647 ($2^{31}-1$)
Writing <i>hysteresis</i>	0 ... 255

Job	Valid range
Writing <i>pulse duration</i> *	0 ... 510ms
*) Only even values allowed. Odd values are automatically rounded.	

Latch function

As soon as during a count process an edge 0-1 is recognized at the "Latch" input of a counter, the recent counter value is stored in the according latch register.

You may access the latch register via *LATCHVAL* of the SFB 47.

A just in *LATCHVAL* loaded value remains after a STOP-RUN transition.

14.2.18 SFB 48 - FREQUENC - Frequency measurement**Description**

The SFB 48 is a specially developed block for compact CPUs for frequency measurement.

- The SFB FREQUENC should cyclically be called (e.g. OB 1) for controlling the frequency measurement.
- The SFB is to be called with the corresponding instance DB. Here the parameters of the SFB are stored.
- Among others the SFB 48 contains a request interface. Hereby you get read and write access to the registers of the frequency meter.
- So that a new job may be executed, the previous job must have been finished with *JOB_DONE* = TRUE.
- Per channel you may call the SFB in each case with the same instance DB, since the data necessary for the internal operation are stored here. Writing accesses to outputs of the instance DB is not permissible.
- With the SFB FREQUENC (SFB 48) you have following functional options:
 - Start/Stop the frequency meter via software gate *SW_GATE*
 - Read the status bit
 - Read the evaluated frequency
 - Request to read/write internal registers of the frequency meter.

Parameters

Name	Declaration	Data type	Address (Inst.-DB)	Default value	Comment
LADDR	INPUT	WORD	0.0	300h	This parameter is not evaluated. Always the internal I/O periphery is addressed.
CHANNEL	INPUT	INT	2.0	0	Channel number
SW_GATE	INPUT	BOOL	4.0	FALSE	Enables the Software gate
JOB_REQ	INPUT	BOOL	4.3	FALSE	Initiates the job (edge 0-1)
JOB_ID	INPUT	WORD	6.0	0	Job ID
JOB_VAL	INPUT	DINT	8.0	0	Value for write jobs
STS_GATE	OUTPUT	BOOL	12.0	FALSE	Status of the internal gate
MEAS_VAL	OUTPUT	DINT	14.0	0	Evaluated frequency
JOB_DONE	OUTPUT	BOOL	22.0	TRUE	New job can be started.

Name	Declaration	Data type	Address (Inst.-DB)	Default value	Comment
JOB_ERR	OUTPUT	BOOL	22.1	FALSE	Job error
JOB_STAT	OUTPUT	WORD	24.0	0	Job error ID

Local data only in instance DB

Name	Data type	Address (Instance DB)	Default	Comment
JOB_OVAL	DINT	28.0	-	Output value for read request.



Per channel you may call the SFB in each case with the same instance DB, since the data necessary for the internal operational are stored here. Writing accesses to outputs of the instance DB is not permissible.

Frequency meter request interface

To read/write the registers of the frequency meter the request interface of the SFB 48 may be used.

So that a new job may be executed, the previous job must have be finished with **JOB_DONE = TRUE**.

Proceeding

The deployment of the request interface takes place at the following sequence:

➔ Edit the following input parameters:

Name	Data type	Address (DB)	Default	Comment
JOB_REQ	BOOL	4.3	FALSE	Initiates the job (edges 0-1)
JOB_ID	WORD	6.0	0	Job ID: 00h Job without function 04h Writes the integration time 84h Read the integration time
JOB_VAL	DINT	8.0	0	Value for write jobs. Permitted value for integration time: 10 ... 10000ms

➔ Call the SFB. The job is processed immediately. **JOB_DONE** only applies to SFB run with the result **FALSE**. **JOB_ERR = TRUE** if an error occurred. Details on the error cause are indicated at **JOB_STAT**.

Name	Data type	Address (DB)	Default	Comment
JOB_DONE	BOOL	22.0	TRUE	New job can be started
JOB_ERR	BOOL	22.1	FALSE	Job error
JOB_STAT	WORD	24.0	0000h	Job error ID 0000h No error 0221h Integration time too low 0222h Integration time too high 02FFh Invalid job ID 8001h Parameter error 8009h Channel no. not valid

1. A new job may be started with *JOB_DONE* = TRUE.

2. A value to be read of a read job may be found in *JOB_OVAL* in the instance DB at address 28.

Channel no. not valid

(8009h and Parameter error 8001h)

If you have preset a CHANNEL number greater than 3, the error "Channel no. not valid" (8009h) is reported. If you have preset a CHANNEL number greater than the maximum channel number of the CPU, "Parameter error" (8001h) is reported.

Controlling frequency meter

The frequency meter is controlled by the internal gate (I gate). The I gate is identical to the software gate (SW gate).

SW gate:

open (activate): In the user program by setting *SW_GATE* of SFB 48

close (deactivate): In the user program by resetting *SW_GATE* of SFB 48

14.2.19 SFB 49 - PULSE - Pulse width modulation

Description

The SFB 49 is a specially developed block for compact CPUs for *PWM* and *pulse train* output. With the SFB PULSE (SFB 49) the following functionalities are available:

- PWM (Pulswidthmodulation)
 - Start/Stop via software gate *SW_EN*
 - Enabling/controlling of the PWM output
 - Read status bits
 - Request to read/write the internal PWM registers
- Configurable pulse train output with a maximum of 2 drive jobs
 - Start/Stop via software gate *SW_EN*
 - Enabling/controlling of the pulse train output
 - Read status bits
 - Request to read/write the internal pulse train registers
- Configurable time base (1µs ... 1ms)

When using the block, the following must be observed:

- The SFB is cyclically to be called with the corresponding instance DB e.g. in OB 1.
- You have read and write access to the corresponding registers via the SFB 49 job interface.

- Per channel you may call the SFB in each case with the same instance DB. Write accesses to outputs of the instance DB is not permissible.
- So that a new job may be executed, the previous job must have be finished with `JOB_DONE = TRUE`.
- The switching between the modes takes place by the presetting of the pulse number (`JOB_ID = 08h/09h`). As soon as you specify a pulse number > 0, you switch to the pulse train mode, otherwise PWM is active.



Please note that some functions of this block are not available in all CPUs. If you call a functionality that is not supported, you receive the error message 04FFh 'Order no. invalid' as Return value. More about the supported functions can also be found in the 'Properties' of your CPU.

Parameter

Parameter	Declaration	Data type	Address (Inst.-DB)	Default Value	Comment
LADDR	INPUT	WORD	0.0	300h	This parameter is not evaluated. Always the internal I/O periphery is addressed.
CHANNEL	INPUT	INT	2.0	0	Channel number
SW_EN	INPUT	BOOL	4.0	FALSE	Enable software gate
MAN_DO	INPUT	BOOL	4.1	FALSE	This parameter is not evaluated.
SET_DO	INPUT	BOOL	4.2	FALSE	This parameter is not evaluated.
OUTP_VAL	INPUT	INT	6.0	0	Output value ↗ 'OUTP_VAL' page 769
JOB_REQ	INPUT	BOOL	8.0	FALSE	Job trigger (edge 0-1)
JOB_ID	INPUT	WORD	10.0	0	Job number ↗ 'JOB_ID' page 769
JOB_VAL	INPUT	DINT	12.0	0	Value for write jobs
STS_EN	OUTPUT	BOOL	16.0	FALSE	Status internal gate
STS_STRT	OUTPUT	BOOL	16.1	FALSE	This parameter is reserved.
STS_DO	OUTPUT	BOOL	16.2	FALSE	This parameter is reserved.
JOB_DONE	OUTPUT	BOOL	16.3	TRUE	Status parameter <ul style="list-style-type: none"> ■ 0: The job has not started or is still running. ■ 1: Job has been executed. A new job can be started.
JOB_ERR	OUTPUT	BOOL	16.4	FALSE	Status parameter <ul style="list-style-type: none"> ■ 0: no error ■ 1: Error (see <code>JOB_STAT</code>)
JOB_STAT	OUTPUT	WORD	18.0	0	↗ 'Return value <code>JOB_STAT</code> ' page 774

OUTP_VAL

The '*output format*' for PWM and pulse train can be set via the hardware configuration. Depending on the output format, there are the following range of values for the *output value*:

- Output in ‰
 - Range of values: 0 ... 1000
 - $Pulse\ duration = (OUTP_VAL / 1000) \times period\ duration$
- Output format: S7 analog value
 - $Pulse\ duration = (OUTP_VAL / 27648) \times period\ duration$
 - Range of values: 0 ... 27648

JOB_ID

Job number

- 00h: Job without function
- 01h: Write *period duration* for PWM and. 1 pulse train job
Range of values in dependence of the time base:
 - 1ms: 1 ... 87
 - 0.1ms: 1 ... 870:
 - 10µs 2 ... 8700
 - 1µs: 20 ... 65535
- 02h: Write *on-delay*
Range of values in dependence of the time base:
 - 1ms: 0 ... 65535
 - 0.1ms: 0 ... 65535
 - 10µs 0 ... 65535
 - 1µs: 0 ... 65535
- 04h: Write *minimum pulse duration*
Range of values in dependence of the time base:
 - 1ms: 0 ... Period duration/2
 - 0.1ms: 0 ... Period duration/2
 - 10µs 0 ... Period duration/2
 - 1µs: 5 ... Period duration/2
- 08h: Write *number of pulses* for the 1. pulse train job
Range of values:
 - 0 ... 8.388.607
- 09h: Write *number of pulses* for the 2. pulse train job
Range of values:
 - 0 ... 8.388.607
- 0Ah: *Period duration* for writing 2. pulse train job
- 0Bh: Write *time base*
 - 00h: 0.1ms
 - 01h: 1ms
 - 02h: 1µs:
 - 03h: 10µs
- 0Ch 2. Attach pulse train job to the 1. pulse train job
 - With this job number, the duty factor for the 2. pulse train job is additionally to be specified via *OUTP_VAL*.
- 81h: Read *period duration* of PWM and 1. pulse train job
- 82h: Read *on-delay*
- 84h: Read *minimum pulse duration*
- 88h: Read *number of pulses* of the 1. pulse train job
- 89h: Read *number of pulses* of the 2. pulse train job

- 8Ah: Read *period duration* of the 2. pulse train job
- 8Bh Read *time base*
 - 00h: 0.1ms
 - 01h: 1ms
 - 02h: 1µs:
 - 03h: 10µs

JOB_VAL

Value for write jobs, which range of values depends on the according job:

-2147483648 (-2^{31}) ... +2147483647 ($2^{31}-1$)

Local data only in instance DB

Name	Data type	Address (Instance DB)	Default	Comment
JOB_OVAL	DINT	20.0	-	Output values for read jobs



Per channel you may call the SFB in each case with the same instance DB, since the data necessary for the internal operational are stored here. Write accesses to outputs of the instance DB is not permissible.

Request interface

- To read/write the registers the request interface of the SFB 49 may be used.
- So that a new job may be executed, the previous job must have be finished with *JOB_DONE* = TRUE.
- With an edge 0-1 at *JOB_REQ*, you can always transfer a job, regardless of the state of *SW_EN* and *STS_EN*.
- Changes of the *period duration* and the *minimum pulse duration* will immediately take effect.
- Changes of the *on-delay* take effect with the next edge 0-1 of *SW_EN*.
- A running PWM output is not affected by setting pulse train specific values such as *pulse number* and *period duration* for the 2. pulse train job.

Controlling the output**Controlling the PWM output**







The request interface is used according to the following sequence:

1. ➔ Call the SFB 49:

- *SW_EN* = FALSE
- *JOB_VAL* = Enter a value for the *period duration* here
- *JOB_ID* = 01h: Write *period duration* for PWM output.
- *JOB_REQ* = TRUE (edge 0-1)



- ⇒
- From *JOB_VAL* the period duration is transmitted to the PWM output.
 - *JOB_DONE* is FALSE during the SFB run.
 - On error *JOB_ERR* = TRUE and the cause of the error is returned in *JOB_STAT*

2. ➔ To reset *JOB_REQ*, call SFB 49 again with the same parameters and *JOB_REQ* = FALSE.

3.  Call the SFB 49:
 - `SW_EN` = FALSE
 - `JOB_VAL` = Enter a value for the *on-delay* here
 - `JOB_ID` = 02h: Write *on-delay* for PWM output.
 - `JOB_REQ` = TRUE (edge 0-1)
 - ⇒ ■ From `JOB_VAL` the *on-delay* is transmitted to the PWM output.
 - `JOB_DONE` is FALSE during the SFB run.
 - On error `JOB_ERR` = TRUE and the cause of the error is returned in `JOB_STAT`
4.  To reset `JOB_REQ`, call SFB 49 again with the same parameters and `JOB_REQ` = FALSE.
5.  Call the SFB 49:
 - `SW_EN` = FALSE
 - `JOB_VAL` = Enter a value for the *minimum pulse duration* here
 - `JOB_ID` = 04h: Write *minimum pulse duration* for PWM output.
 - `JOB_REQ` = TRUE (edge 0-1)
 - ⇒ ■ From `JOB_VAL` the *minimum pulse duration* is transmitted to the PWM output.
 - `JOB_DONE` is FALSE during the SFB run.
 - On error `JOB_ERR` = TRUE and the cause of the error is returned in `JOB_STAT`
6.  To reset `JOB_REQ`, call SFB 49 again with the same parameters and `JOB_REQ` = FALSE.
7.  Call the SFB 49:
 - `SW_EN` = TRUE (edge 0-1)
 - `JOB_REQ` = TRUE (edge 0-1)
 - `OUTP_VAL`: Specify a duty factor.
 - ⇒ ■ The PWM output is started
 - `STS_EN` goes to TRUE and remains in this state until SFB 49 is called with `SW_EN` = FALSE.
 - On error `JOB_ERR` = TRUE and the cause of the error is returned in `JOB_STAT`
8.  Call the SFB 49 cyclically:
 - `SW_EN` = FALSE
 - Via `STS_EN` you get the current status of the PWM output. With `OUTP_VAL` you can always change the duty factor.
9.  As soon as `JOB_DONE` returns TRUE, you can change the PWM parameters by repeating the steps 1 to 5.



If values are changed during PWM output, the new values are only output with the beginning of a new period. A started period is always finished!

10.  By resetting of `SW_EN` (`SW_EN` = FALSE) the output is immediately stopped.
11.  With reading jobs, you can find the values to be read in the parameter `JOB_OVAL` in the instance DB at address 20.

Controlling the pulse train output

The request interface is used according to the following sequence:

1. **1.** Call the SFB 49:
 - `SW_EN` = FALSE
 - `JOB_VAL` = Enter a value for the *number of pulses* here.
 - `JOB_ID` = 08h: Write *number of pulses* for the 1. pulse train job.
 - `JOB_REQ` = TRUE (edge 0-1)

⇒

 - From `JOB_VAL` the *number of pulses* for the 1. pulse train job is transmitted.
 - `JOB_DONE` is FALSE during the SFB run.
 - On error `JOB_ERR` = TRUE and the cause of the error is returned in `JOB_STAT`
2. **2.** To reset `JOB_REQ`, call SFB 49 again with the same parameters and `JOB_REQ` = FALSE.
3. **3.** Call the SFB 49:
 - `SW_EN` = FALSE
 - `JOB_VAL` = Enter a value for the *period duration* here.
 - `JOB_ID` = 01h: Write *period duration* for the 1. pulse train job.
 - `JOB_REQ` = TRUE (edge 0-1)

⇒

 - From `JOB_VAL` the *period duration* for the 1. pulse train job is transmitted.
 - `JOB_DONE` is FALSE during the SFB run.
 - On error `JOB_ERR` = TRUE and the cause of the error is returned in `JOB_STAT`
4. **4.** To reset `JOB_REQ`, call SFB 49 again with the same parameters and `JOB_REQ` = FALSE.
5. **5.** Optional for the 2. pulse train job: Call the SFB 49:
 - `SW_EN` = FALSE
 - `JOB_VAL` = Enter a value for the *number of pulses* here.
 - `JOB_ID` = 09h: Write *number of pulses* for the 2. pulse train job.
 - `JOB_REQ` = TRUE (edge 0-1)

⇒

 - The *number of pulses* for the 2. pulse train job is transmitted.
 - `JOB_DONE` is FALSE during the SFB run.
 - On error `JOB_ERR` = TRUE and the cause of the error is returned in `JOB_STAT`
6. **6.** To reset `JOB_REQ`, call SFB 49 again with the same parameters and `JOB_REQ` = FALSE.
7. **7.** Optional for the 2. pulse train job: Call the SFB 49:
 - `SW_EN` = FALSE
 - `JOB_VAL` = Enter a value for the *period duration* here.
 - `JOB_ID` = 0Ah: Write *period duration* for the 2. pulse train job.
 - `JOB_REQ` = TRUE (edge 0-1)

⇒

 - From `JOB_VAL` the *period duration* for the 2. pulse train job is transferred.
 - `JOB_DONE` is FALSE during the SFB run.
 - On error `JOB_ERR` = TRUE and the cause of the error is returned in `JOB_STAT`
8. **8.** To reset `JOB_REQ`, call SFB 49 again with the same parameters and `JOB_REQ` = FALSE.

9. Call the SFB 49:
 - `SW_EN` = TRUE (edge 0-1)
 - `JOB_REQ` = TRUE (edge 0-1)
 - `OUTP_VAL`: Enter the duty factor such as 50%.

⇒

 - The 1. pulse train job is started and then if present the 2. pulse train job.
 - Via `STS_EN` you get the current status of the pulse train output. As long as the required number of pulses is output, `STS_EN` returns TRUE. `STS_EN` returns FALSE if either the requested number of pulses has been output or output with `SW_EN` = FALSE was terminated early.
 - On error `JOB_ERR` = TRUE and the cause of the error is returned in `JOB_STAT`
10. To reset `JOB_REQ`, call SFB 49 again with the same parameters and `JOB_REQ` = FALSE.
11. Call the SFB 49 cyclically:
 - `SW_EN` = FALSE
 - Via `STS_EN` you get the current status of the pulse train output.
12. As soon as `JOB_DONE` returns TRUE, you can transfer additional pulse train jobs by repeating the steps 1 to 6.
13. By resetting of `SW_EN` (`SW_EN` = FALSE) the output is immediately stopped.
14. With reading jobs, you can find the values to be read in the parameter `JOB_OVAL` in the instance DB at address 20.

Extend a running pulse train job

As long as only one pulse train job is defined and currently being processed, there is the possibility to attach a 2. pulse train job to the 1. pulse train job.

1. Call the SFB 49:
 - `SW_EN` = TRUE (edge 0-1)
 - `JOB_VAL` = Enter a value for the *number of pulses* here.
 - `JOB_ID` = 09h: Write *number of pulses* for the 2. pulse train job.
 - `JOB_REQ` = TRUE (edge 0-1)

⇒

 - From `JOB_VAL` the *number of pulses* for the 2. pulse train job is transmitted.
 - `JOB_DONE` is FALSE during the SFB run.
 - On error `JOB_ERR` = TRUE and the cause of the error is returned in `JOB_STAT`
2. To reset `JOB_REQ`, call SFB 49 again with the same parameters and `JOB_REQ` = FALSE.
3. Call the SFB 49:
 - `SW_EN` = TRUE
 - `JOB_VAL` = Enter a value for the *period duration* here.
 - `JOB_ID` = 0Ah: Write *period duration* for the 2. pulse train job.
 - `JOB_REQ` = TRUE (edge 0-1)

⇒

 - From `JOB_VAL` the *period duration* for the 2. pulse train job is transferred.
 - `JOB_DONE` is FALSE during the SFB run.
 - On error `JOB_ERR` = TRUE and the cause of the error is returned in `JOB_STAT`
4. To reset `JOB_REQ`, call SFB 49 again with the same parameters and `JOB_REQ` = FALSE.

5. Call the SFB 49:

- `SW_EN` = TRUE (edge 0-1)
 - `JOB_ID` = 0Ch: Attach 2. pulse train job to the 1. pulse train job.
 - `JOB_REQ` = TRUE (edge 0-1)
 - `OUTP_VAL`: Enter the duty factor such as 50%.
- ⇒
- As long as the 1. pulse train job is still running, the 2. pulse train job is attached. Otherwise you receive the error message 0461h as *return value*.
 - Via `STS_EN` you get the current status of the pulse train output. As long as the required number of pulses is output, `STS_EN` returns TRUE. `STS_EN` returns FALSE if either the requested number of pulses has been output or output with `SW_EN` = FALSE was terminated early.
 - On error `JOB_ERR` = TRUE and the cause of the error is returned in `JOB_STAT`



Please note that a maximum of 2 pulse train jobs can be executed directly after another!

Return value `JOB_STAT`

The `JOB_STAT` return value gives you detailed information in the event of an error.

Value	Description
0000h	no error
0411h	<i>Period duration</i> too small
0412h	<i>Period duration</i> too big
0421h	<i>On-delay</i> too small
0422h	<i>On-delay</i> too big
0431h	<i>Minimum pulse duration</i> too small
0432h	<i>Minimum pulse duration</i> too big
0441h	<i>Number of pulses</i> too small
0442h	<i>Number of pulses</i> too big
0451h	Invalid <i>time base</i>
0461h	Pulse train job could not be attached
04FFh	Job number not valid You receive this error message e.g. if the corresponding functionality is not supported by your CPU.
8001h	Parametrization error You will get a parametrization error (8001h), if you have transmitted a channel number with <code>CHANNEL</code> , which is bigger than the max. available number of channels of the CPU.
8009h	Channel no. not valid You will get the return value channel no. not valid (8009h), if you have transmitted a channel number with <code>CHANNEL</code> , which is bigger than 3.

14.2.20 SFB 52 - RDREC - Reading record set



The SFB 52 RDREC interface is identical to the FB RDREC defined in the standard "PROFIBUS Guideline PROFIBUS Communication and Proxy Function Blocks according to IEC 61131-3".

Description

With the SFB 52 RDREC (read record) you can read a record set with the number *INDEX* from a module that has been addressed via *ID*. Specify the maximum number of bytes you want to read in *MLEN*. The selected length of the target area *RECORD* should have at least the length of *MLEN* bytes. *TRUE* on output parameter *VALID* verifies that the record set has been successfully transferred into the target area *RECORD*. In this case, the output parameter *LEN* contains the length of the fetched data in bytes. The output parameter *ERROR* indicates whether a record set transmission error has occurred. In this case, the output parameter *STATUS* contains the error information. System dependent this block cannot be interrupted!

Operating principle

The SFB 52 RDREC operates asynchronously, that is, processing covers multiple SFB calls. Start the job by calling SFB 52 with *REQ* = 1. The job status is displayed via the output parameter *BUSY* and bytes 2 and 3 of output parameter *STATUS*. Here, the *STATUS* bytes 2 and 3 correspond with the output parameter *RET_VAL* of the asynchronously operating SFCs (see also meaning of *REQ*, *RET_VAL* and *BUSY* with Asynchronously Operating SFCs). Record set transmission is completed when the output parameter *BUSY* = *FALSE*.

Parameters

Parameter	Declaration	Data type	Memory block	Description
REQ	INPUT	BOOL	I, Q, M, D, L, constant	<i>REQ</i> = 1: Transfer record set
ID	INPUT	DWORD	I, Q, M, D, L, constant	Logical address of the module For an output module, bit 15 must be set (e.g. for address 5: <i>ID</i> : DW = 8005h). For a combination module, the smaller of the two addresses should be specified.
INDEX	INPUT	INT	I, Q, M, D, L, constant	Record set number
MLEN	INPUT	INT	I, Q, M, D, L, constant	Maximum length in bytes of the record set information to be fetched
VALID	OUTPUT	BOOL	I, Q, M, D, L	New record set was received and valid
BUSY	OUTPUT	BOOL	I, Q, M, D, L	<i>BUSY</i> = 1: The read process is not yet terminated.
ERROR	OUTPUT	BOOL	I, Q, M, D, L	<i>ERROR</i> = 1: A read error has occurred.
STATUS	OUTPUT	DWORD	I, Q, M, D, L	Call <i>ID</i> (bytes 2 and 3) or error code.
LEN	OUTPUT	INT	I, Q, M, D, L	Length of the fetched record set information.
RECORD	IN_OUT	ANY	I, Q, M, D, L	Target area for the fetched record set.

Error information

↳ *Chap. 14.2.22 'SFB 54 - RALRM - Receiving an interrupt from a periphery module' page 777*

14.2.21 SFB 53 - WRREC - Writing record set



The SFB 53 WRREC interface is identical to the FB WRREC defined in the standard "PROFIBUS Guideline PROFIBUS Communication and Proxy Function Blocks according to IEC 61131-3".

Description

With the SFB 53 WRREC (Write record) you transfer a record set with the number *INDEX* to a module that has been addressed via *ID*. Specify the byte length of the record set to be transmitted. The selected length of the source area *RECORD* should, therefore, have at least the length of *LEN* bytes. TRUE on output parameter *DONE* verifies that the record set has been successfully transferred to the DP slave. The output parameter *ERROR* indicates whether a record set transmission error has occurred. In this case, the output parameter *STATUS* contains the error information. System dependent this block cannot be interrupted!

Operating principle

The SFB 53 WRREC operates asynchronously, that is, processing covers multiple SFB calls. Start the job by calling SFB 52 with *REQ* = 1. The job status is displayed via the output parameter *BUSY* and bytes 2 and 3 of output parameter *STATUS*. Here, the *STATUS* bytes 2 and 3 correspond with the output parameter *RET_VAL* of the asynchronously operating SFCs (see also meaning of *REQ*, *RET_VAL* and *BUSY* with Asynchronously Operating SFCs). Please note that you must assign the same value to the actual parameter of *RECORD* for all SFB 53 calls that belong to one and the same job. The same applies to the *LEN* parameters. Record set transmission is completed when the output parameter *BUSY* = FALSE.

Parameters

Parameter	Declaration	Data type	Memory block	Description
REQ	INPUT	BOOL	I, Q, M, D, L, constant	REQ = 1: Transfer record set
ID	INPUT	DWORD	I, Q, M, D, L, constant	Logical address of the module. For an output module, bit 15 must be set (e.g. for address 5: ID: DW = 8005h). For a combination module, the smaller of the two addresses should be specified.
INDEX	INPUT	INT	I, Q, M, D, L, constant	Record set number.
LEN	INPUT	INT	I, Q, M, D, L, constant	Maximum byte length of the record set to be transferred.
DONE	OUTPUT	BOOL	I, Q, M, D, L	Record set was transferred.
BUSY	OUTPUT	BOOL	I, Q, M, D, L	BUSY = 1: The write process is not yet terminated.
ERROR	OUTPUT	BOOL	I, Q, M, D, L	ERROR = 1: A write error has occurred.

Parameter	Declaration	Data type	Memory block	Description
STATUS	OUTPUT	DWORD	I, Q, M, D, L	Call ID (bytes 2 and 3) or error code.
RECORD	IN_OUT	ANY	I, Q, M, D, L	Record set

Error information

 *Chap. 14.2.22 'SFB 54 - RALRM - Receiving an interrupt from a periphery module' page 777*

14.2.22 SFB 54 - RALRM - Receiving an interrupt from a periphery module**14.2.22.1 Parameters**

The SFB 54 RALRM interface is identical to the FB RALRM defined in the standard "PROFIBUS Guideline PROFIBUS Communication and Proxy Function Blocks according to IEC 61131-3".

Description

The SFB 54 RALRM receives an interrupt with all corresponding information from a peripheral module or a component of the corresponding bus slave and provides this information to its output parameters. The information contained in the input parameters contains the start information of the called OB as well as information from the interrupt source. Call the SFB 54 only within the interrupt OB started by the CPU operating system as a result of the peripheral interrupt that is to be examined.



If you call SFB 54 RALRM in an OB for which the start event was not triggered by peripherals, the SFB supplies correspondingly reduced information on its outputs.

Make sure to use different instance DBs when you call SFB 54 in different OBs. If you want to evaluate data that are the result of an SFB 54 call outside of the associated interrupt OB you should moreover use a separate instance DP per OB start event.

Parameters

Parameter	Declaration	Data type	Memory block	Description
MODE	INPUT	INT	I, Q, M, D, L, constant	Operating mode
F_ID	INPUT	DWORD	I, Q, M, D, L, constant	Logical start address of the Component (module), from which interrupts are to be received.
MLEN	INPUT	INT	I, Q, M, D, L, constant	Maximum length in bytes of the data interrupt information to be received
NEW	OUTPUT	BOOL	I, Q, M, D, L	TRUE: A new interrupt was received. FALSE: No new interrupt was received.
STATUS	OUTPUT	DWORD	I, Q, M, D, L	C0000000h: no error C080C300h: Resources are presently occupied C0809000h: Invalid logical start address Only PROFINET IO: C080A000h: Read error C080B700h: Invalid area
ID	OUTPUT	DWORD	I, Q, M, D, L	Logical start address of the component (module), from which an interrupt was received. Bit 15 contains the I/O ID: 0: for an input address 1: for an output address
LEN	OUTPUT	INT	I, Q, M, D, L	Length of the received interrupt information
TINFO	IN_OUT	ANY	I, Q, M, D, L	(task information) Target range OB start and management information
AINFO	IN_OUT	ANY	I, Q, M, D, L	(interrupt information) Target area for header information and additional information. For <i>AINFO</i> you should provide a length of at least <i>MLEN</i> bytes.

MODE

You can call the SFB 54 in three operating modes (*MODE*):

- 0: shows the component that triggered the interrupt in the output parameter *ID* and sets the output parameter *NEW* to TRUE.
- 1: describes all output parameters, independent on the interrupt-triggering component.
- 2: checks whether the component specified in input parameter *F_ID* has triggered the interrupt.
 - if not, *NEW* = FALSE
 - if yes, *NEW* = TRUE, and all other outputs parameters are described.



If you select a target area TINFO or AINFO that is too short the SFC 54 cannot enter the full information.

TINFO

TINFO PROFIBUS: Data structure of the target area (task information)						
Byte	Data type	Description				
0 ... 19		Start information of the OB in which the SFC 54 was currently called Byte 0 ... 11: structured like the parameter <i>TOP_SI</i> in SFC 6 RD_SINFO Byte 12 ... 19: date and time the OB was requested				
20 ... 27		Management information:				
20	Byte	centralized: 0 decentralized: DP master system ID (possible values: 1 ... 255)				
21	Byte	central: Module rack number (possible values: 0 ... 31) distributed: Number of DP station (possible values: 0 ... 127)				
22	Byte	centralized: 0				
		decentral- ized:	Bit 3 ... 0	Slave type	0000:	DP
					0001:	DPS7
					0010:	DPS7 V1
					0011:	DP-V1
					ab 0100:	reserved
		Bit 7 ... 4	Profile type	0000:	DP	
ab 0001:	reserved					
23	Byte	centralized: 0				
		decentral- ized:	Bit 3 ... 0	Interrupt info type	0000:	Transparent (Interrupt originates from a configured decentralized module)
					0001:	Representative (Interrupt originating from a non-DP-V1 slave or a slot that is not configured)
					0010:	Generated interrupt (gen- erated in the CPU)
					as of 0011:	reserved
		Bit 7 ... 4	Structure version	0000:	Initial	
as of 0001:	reserved					
24	Byte	centralized: 0				
		decentralized: Flags of the DP master interface				
		Bit 0 = 0:		Interrupt originating from an integrated DP interface		
		Bit 0 = 1:		Interrupt originating from an external DP interface		
		Bit 7 ... 1:		reserved		
25	Byte	centralized: 0				
		decentralized: Flags of the DP slave interface				

TINFO PROFIBUS: Data structure of the target area (task information)

Byte	Data type	Description
		Bit 0: EXT_DIAG_Bit of the diagnostic message frame, or 0 if this bit does not exist in the interrupt
		Bit 7 ... 1: reserved
26, 27	WORD	centralized: 0
		decentralized: PROFIBUS ID number

TINFO PROFINET IO: Data structure of the target area (task information)

Byte	Declaration	Data type	Description
0 ... 19	OB Startinfo	BYTE	Start information of the OB in which the SFC 54 was currently called:
20 ... 21	Addressinfo	WORD	Bit 0 ... 10: Number of the DP station (0-2047) Bit 11 ... 14: the last two digits of the PROFINET IO system ID (0-15), to get the whole PROFINET IO system ID you have to add 100 (decimal). Bit 15: 1
22	Slavetype	BYTE	Bit 0 ... 3: 1000: Fixed value for PROFINET IO Bit 4 ... 7: reserved
23	Alarminfo	BYTE	Bit 0 ... 3: 0000: Transparent, which is always the case for PROFINET IO (interrupt originates from a configured distributed module) Bit 4 ... 7: reserved
24	PROFINET IO controller interface	BYTE	Flags of the PROFINET IO controller interface module Bit 0: 0: Interrupt originating from an integrated interface Bit 0: 1: Interrupt originating from an external interface Bit 1 ... 7: reserved
25	Flags of the PROFINET IO controller interface	BYTE	Bit 0: AR data status failure bit of the interrupt message frame or "0" if there is no information in the interrupt Bit 0: 1: IO device is faulty Bit 1... 7: reserved
26 ... 27	PROFINET IO device ID number	WORD	PROFINET IO device ID number as unique identifier of the PROFINET IO device
28 ... 29		WORD	Manufacturer ID
30 ... 31	ID	WORD	ID number of the instance

TINFO EtherCAT: Data structure of the target area (task information)

Byte	Declaration	Data type	Description
0 ... 19	OB Startinfo	BYTE	Start information of the OB in which the SFC 54 was currently called.
20 ... 21	Addressinfo	WORD	Bit 0 ... 10: Master/Slave Bit 11 ... 14: System ID EtherCAT network - 100 Bit 15: 1: Bit for EtherCAT (PROFINET "look and feel")
22	Slavetype	BYTE	Bit 0 ... 3: 1000: 0b1111 EtherCAT ¹ Bit 4 ... 7: reserved
23	Alarminfo	BYTE	Bit 0 ... 3: 0000: Transparent, interrupt originates from a configured distributed module Bit 4 ... 7: reserved
24	EC Flags I	BYTE	Flags of the EtherCAT IO controller interface Bit 0: 0: Interrupt originating from an integrated interface 1: Interrupt originating from an external interface Bit 1 ... 7: reserved
25 ... 31			reserved

1) At 0b1001 PROFINET IO

AINFO

AINFO PROFIBUS: Data structure of the target area (interrupt information)				
Byte	Data type	Description		
0 ... 3		Header information		
0	Byte	Length of the received interrupt information in bytes		
		centralized: 4 ... 224		
		decentralized: 4 ... 63		
1	Byte	centralized: reserved		
		decentralized:	ID for the interrupt type	
			1:	Diagnostic interrupt
			2:	Hardware interrupt
			3:	Removal interrupt
			4:	Insertion interrupt
			5:	Status interrupt
			6:	Update interrupt
			31:	Failure of an expansion device, DP master system or DP station
32 ... 126	manufacturer specific interrupt			
2	Byte	Slot number of the interrupt triggering component		
3	Byte	centralized: reserved		
		decentralized:	Identifier	
			Bit 1, 0:	
			00	no further information
			01	incoming event, disrupted slot
			10	going event, slot not disrupted anymore
			11	going event, slot still disrupted
			Bit 2:	Add_Ack
Bit 7 ... 3	Sequence number			
4 ... 223		Additional interrupt information: module specific data for the respective interrupt:		
		centralized:	ARRAY[0] ... ARRAY[220]	
		decentralized:	ARRAY[0] ... ARRAY[59]	

AINFO PROFINET IO: Data structure of the target area (interrupt information)

Byte	Declaration	Data type	Description
0 ... 1	Block type	WORD	Bit 0 ... 7: Block type Bit 8 ... 15: reserved
2 ... 3	Block length	WORD	Length of the received interrupt information in byte MIN: 0 MAX: 1536 (1.5kbyte)
4 ... 5	Version	WORD	Bits 0 ... 7: low byte Bits 8 ... 15: high byte

AINFO PROFINET IO: Data structure of the target area (interrupt information)

Byte	Declaration	Data type	Description
6 ... 7	Interrupt type	WORD	<p>Identifier for the interrupt type:</p> <ul style="list-style-type: none"> 1: Diagnostic interrupt (incoming) 2: Hardware interrupt 3: Removal interrupt 4: Insertion interrupt 5: Status interrupt 6: Update interrupt 7: Redundancy interrupt 8: Controlled by supervisor 9: Released by supervisor 10: Configured module not inserted 11: Return of submodule 12: Diagnostic interrupt (exiting state) 13: Direct data exchange connection message 14: Neighbourhood change message 15: Clock synchronization message (from bus) 16: Clock synchronization message (from device) 17: Network component message 18: Time synchronization message (from bus) 19 to 31: Reserved 32 to 127: Vendor-specific interrupt 128 ... 65535: reserved, without the following VIPA specific interrupt types: 38CAh: Recovery of the controller 48CAh: Configuration of the controller accepted 39CAh: Controller failure 49CAh: Failure of the controller due to the watchdog 38CBh: Recovery of the device 38CCh: Failure of the recovery of the device 38CDh: Another device is detected during the recovery of the device. 38CEh: Parameter error during the recovery of the device 39CBh: Device failure
8 ... 11	API	DWORD	API (Application Process Identifier)
12 ... 13	Slot number	WORD	Slot number of the component triggering the interrupt (range of values 0 to 65535)
14 ... 15	Interface module slot number	WORD	Interface module slot number of the component triggering the interrupt (range of values 0 to 65535)
16 ... 19	Module ID	DWORD	Specific information on the source of the interrupt: Module ID

AINFO PROFINET IO: Data structure of the target area (interrupt information)

Byte	Declaration	Data type	Description
20 ... 23	Submodule ID	DWORD	Specific information on the source of the interrupt: Submodule ID
24 ... 25	Interrupt specifier	WORD	<p>Bits 0 to 10: Sequence number (range of values: 0 to 2047)</p> <p>Bit 11: Channel diagnostics: 0: No channel diagnostics available 1: Channel diagnostics available</p> <p>Bit 12: Status of manufacturer-specific diagnostics: 0: No manufacturer-specific status information available 1: Manufacturer-specific status information available</p> <p>Bit 13: Status of diagnostics for interface module: 0: No status information available; all errors corrected 1: Diagnostics for at least one channel and/or status information available</p> <p>Bit 14: reserved</p> <p>Bit 15: Application Relationship Diagnosis State 0: None of the configured modules within this AR is reporting a diagnosis 1: At least one of the configured modules within this AR is reporting a diagnosis</p>
26 ... 1535	Interrupt specifier	WORD	<p>Note: The additional interrupt specifier can also be omitted.</p>

AINFO EtherCAT: Data structure of the target area (interrupt information)

Byte	Declaration	Data type	Description
0, 1	Length	WORD	Length of the received interrupt information in byte: MIN: 0 MAX: 1535 (1.5kbyte)
2, 3	InterruptType	WORD	ID of the interrupt type: 0001h: DIAGNOSTICS_INTERRUPT_COMMING 0002h: HARDWARE_INTERRUPT 000Ch: DIAGNOSTICS_INTERRUPT_GOING 0020h: MANUFACTOR_SPECIFIC_ALARM_MIN // VIPA specific: 39CAh: CONTROLLER_FAILURE 49CAh: CONTROLLER_FAILURE_WATCHDOG // EtherCAT specific: 8001h: BUS_STATE_CHANGED 8002h: SLAVE_STATE_CHANGED 8003h: TOPOLOGY_OK 8004h: TOPOLOGY_MISMATCH
4, 5	RackSlot	WORD	Slot number of the EtherCAT master
6, 7	Master/Slave ID	WORD	EtherCAT master/slave address
8, 9	InterruptSpecifier	WORD	Value depends on the interrupt type: InterruptType: Value BUS_STATE_CHANGED: new bus status ¹ DIAGNOSTICS_INTERRUPT_GOING: reserved DIAGNOSTICS_INTERRUPT_COMMING: reserved HARDWARE_INTERRUPT: reserved MANUFACTOR_SPECIFIC_ALARM_MIN: reserved SLAVE_STATE_CHANGED: new bus status CONTROLLER_FAILURE: reserved CONTROLLER_FAILURE_WATCHDOG: reserved TOPOLOGY_OK: reserved TOPOLOGY_MISMATCH: reserved

AINFO EtherCAT: Data structure of the target area (interrupt information)

Byte	Declaration	Data type	Description
10 ... n	Data	BYTE	Content depends on the InterruptType: AlarmType: Content BUS_STATE_CHANGED: Data structure ² DIAGNOSTICS_INTERRUPT_GOING: CoE-Emergency ³ DIAGNOSTICS_INTERRUPT_COMMING: CoE-Emergency PROCESS_INTERRUPT: CoE-Emergency MANUFACTOR_SPECIFIC_INTERRUPT_MIN: CoE-Emergency SLAVE_STATE_CHANGED: AL Status Code ⁴ CONTROLLER_FAILURE: Failure code ⁵ CONTROLLER_FAILURE_WATCHDOG: reserved TOPOLOGY_OK: reserved TOPOLOGY_MISMATCH: reserved

1) EtherCAT-States ↗ 788

2) Data structure BUS_STATE_CHANGED ↗ 789

3) CoE emergency ↗ 789

4) AL Status Code ↗ 789

5) Failure code ↗ 789

14.2.22.2 EtherCAT-States

The bus states are coded as follows

Name	Code	Description
Undefined/Unknown	0x00	This status has a slave before he could carry out its initialization routines. For the VIPA EtherCAT master a slave has the undefined state, if there is a slave failure (disconnect).
Init	0x01	There is no direct communication between master and slaves. In this state the master initializes the configuration register of the ESC. There is no process data or mailbox communication.
PreOp	0x02	In this state mailbox communication is possible, but there is no process data communication.
BootStrap	0x03	Special state of the EtherCAT slave, there only mailbox communication takes place. For a firmware update of the slave, the slave must be switched in this state.
SafeOp	0x04	In the state SafeOp mailbox communication is possible an process input data can be exchanged. However, there will be no exchange of process output data.
Op	0x08	In this state mailbox and process data can be exchanged.

14.2.22.3 Cause of controller failure

On a controller failure the alarm specifier provides information about the cause of the failure

Name	Code	Description
REASON_UNKNOWN	0	The reason is unknown
ALARM_OVERFLOW	1	Overflow of interrupts
MESSAGE_QUEUE_OVERFLOW	2	Overflow of EtherCAT events
CYCLIC_FRAMES_NOT_IN_BUSCYCLE	3	EtherCAT receive telegram was not received within the bus cycle time
APPL_BUSCYCLE_ERROR	4	Bus cycle time could not be fetched e.g. due to a high system load

14.2.22.4 CoE emergency

A CoE emergency is a special type of mailbox communication in the EtherCAT slave. Here the EtherCAT slave can signalise the EtherCAT master that an error has occurred. It has the following structure:

Name	Data type	Description
Error Code	WORD	Error Code
Error Register	BYTE	EtherCAT state on the error of the slave
Data	BYTE[5]	Manufacturer Specific Error Field (MEF), contains additional diagnostics data

14.2.22.5 AL Status Code

AL is the abbreviation for Application Layer. The AL status code is an error code of the slave application.

14.2.22.6 Data structure BUS_STATE_CHANGED

Header

- NrOfSlavesTotal - Number of slaves, which are not in master state
- NrOfSlavesUndefined - Number of slaves in state *undefined*
- NrOfSlavesInit - Number of slaves in state *Init*
- NrOfSlavesPreop - Number of slaves in state *PreOp*
- NrOfSlavesBootstrap - Number of slaves in state *Bootstrap*
- NrOfSlavesSafeop - Number of slaves in state *SafeOp*
- NrOfSlavesOp - Number of slaves in state *Op*

DeviceId

DeviceId[0] ... - EtherCAT address of the slave as defined in the configuration

DeviceId[NrOfSlaves-Total-1] - EtherCAT address of the slave as defined in the configuration

TINFO and AINFO

Depending on the respective OB in which SFB 54 is called, the target areas TINFO and AINFO are only partially written. Refer to the table below for information on which info is entered respectively.

Target Area					
Interrupt type	OB	TINFO OB status information	TINFO manage- ment infor- mation	AINFO header infor- mation	AINFO additional interrupt information
Hardware interrupt	4x	Yes	Yes	Yes	centralized: No.
					decentralized: as delivered by the DP slave
Status interrupt	55	Yes	Yes	Yes	Yes
Update interrupt	56	Yes	Yes	Yes	Yes
Manufacturer specific interrupt	57	Yes	Yes	Yes	Yes
Peripheral redundancy error	70	Yes	Yes	No	No
Diagnostic interrupt	82	Yes	Yes	Yes	centralized: Record set 1
					decentralized: as delivered by the DP slave
Removal/ Insertion interrupt	83	Yes	Yes	Yes	centralized: no
					decentralized: as delivered by the DP slave
Module rack/Station failure	86	Yes	Yes	No	No
...	all other OBs	Yes	No	No	No

Error information

The output parameter *STATUS* contains information. It is interpreted as ARRAY[1...4] OF BYTE the error information has the following structure:

Field element	Name	Description
STATUS[1]	Function_Num	00h: if no error Function ID from DP-V1-CPU: in error case 80h is OR linked. If no DP-V1 protocol element is used: C0h
STATUS[2]	Error Decode	Location of the error ID
STATUS[3]	Error_1	Error ID
STATUS[4]	Error_2	Manufacturer specific error ID expansion: With DP-V1 errors, the DP master passes on <i>STATUS[4]</i> to the CPU and to the SFB. Without DP-V1 error, this value is set to 0, with the following exceptions for the SFB 52: <ul style="list-style-type: none"> ■ <i>STATUS[4]</i> contains the target area length from RECORD, if <i>MLEN</i> > the target area length from <i>RECORD</i> ■ <i>STATUS[4]=MLEN</i>, if the actual record set length < <i>MLEN</i> < the target area length from <i>RECORD</i>.

STATUS[2] (Location of the error ID) can have the following values:

Error Decode	Source	Description
00 ... 7Fh	CPU	No error no warning
80h	DP-V1	Error according to IEC 61158-6
81h ... 8Fh	CPU	8xh shows an error in the nth call parameter of the SFB.
FEh, FFh	DP Profile	Profile-specific error

STATUS[3] (Error ID) can have the following values:

Error Decode	Error_Code_1	Explanation according to DP-V1	Description
00h	00h		no error, no warning
70h	00h	reserved, reject	Initial call; no active record set transfer
	01h	reserved, reject	Initial call; record set transfer has started
	02h	reserved, reject	Intermediate call; record set transfer already active
80h	90h	reserved, pass	Invalid logical start address
	92h	reserved, pass	Illegal Type for ANY Pointer
	93h	reserved, pass	The DP component addressed via <i>ID</i> or <i>F_ID</i> is not configured.

STATUS[3] (Error ID) can have the following values:

Error_Decode	Error_Code_1	Explanation according to DP-V1	Description
	A0h	read error	Negative acknowledgement while reading the module.
	A1h	write error	Negative acknowledgement while writing the module.
	A2h	module failure	DP protocol error at layer 2
	A3h	reserved, pass	DP protocol error with Direct-Data-Link-Mapper or User-Interface/User
	A4h	reserved, pass	Bus communication disrupted
	A5h	reserved, pass	-
	A7h	reserved, pass	DP slave or module is occupied (temporary error)
	A8h	version conflict	DP slave or module reports noncompatible versions
	A9h	feature not supported	Feature not supported by DP slave or module
	AA ... AFh	user specific	DP slave or module reports a manufacturer specific error in its application. Please check the documentation from the manufacturer of the DP slave or module.
	B0h	invalid index	Record set not known in module illegal record set number ≥ 256 .
	B1h	write length error	Wrong length specified in parameter <i>RECORD</i> ; with SFB 54: length error in <i>AINFO</i> .
	B2h	invalid slot	Configured slot not occupied.
	B3h	type conflict	Actual module type not equal to specified module type.
	B4h	invalid area	DP slave or module reports access to an invalid area.
	B5h	state conflict	DP slave or module not ready
	B6h	access denied	DP slave or module denies access
	B7h	invalid range	DP slave or module reports an invalid range for a parameter or value.
	B8h	invalid parameter	DP slave or module reports an invalid parameter.
	B9h	invalid type	DP slave or module reports an invalid type.
	BAh ... BFh	user specific	DP slave or module reports a manufacturer specific error when accessing. Please check the documentation from the manufacturer of the DP slave or module.
	C0h	read constrain conflict	The module has the record set, however, there are no read data yet.

STATUS[3] (Error ID) can have the following values:

Error_Decode	Error_Code_1	Explanation according to DP-V1	Description
	C1h	write constrain conflict	The data of the previous write request to the module for the same record set have not yet been processed by the module.
	C2h	resource busy	The module currently processes the maximum possible jobs for a CPU.
	C3h	resource unavailable	The required operating resources are currently occupied.
	C4h		Internal temporary error. Job could not be carried out. Repeat the job. If this error occurs often, check your plant for sources of electrical interference.
	C5h		DP slave or module not available
	C6h		Record set transfer was canceled due to priority class cancellation.
	C7h		Job canceled due to restart of DP masters.
	C8h ... CFh		DP slave or module reports a manufacturer specific resource error. Please check the documentation from the manufacturer of the DP slave or module.
	Dxh	user specific	DP slave specific,
81h	00h ... FFh		Error in the initial call parameter (with SFB 54: MODE)
	00h		Illegal operating mode
82h	00h ... FFh		Error in the 2. call parameter.
...
88h	00h ... FFh		Error in the 8. call parameter (with SFB 54: TINFO)
	01h		Wrong syntax ID
	23h		Quantity frame exceeded or target area too small
	24h		Wrong range ID
	32h		DB/DI no. out of user range
	3Ah		DB/DI no. is zero for area ID DB/DI or specified DB/DI does not exist.
89h	00h ... FFh		Error in the 9. call parameter (with SFB 54: AINFO)
	01h		Wrong syntax ID
	23h		Quantity frame exceeded or target area too small
	24h		Wrong range ID

STATUS[3] (Error ID) can have the following values:

Error_Decode	Error_Code_1	Explanation according to DP-V1	Description
	32h		DB/DI no. out of user range
	3Ah		DB/DI no. is zero for area ID DB/DI or specified DB/DI does not exist
8Ah	00h ... FFh		Error in the 10. call parameter
...
8Fh	00h ... FFh		Error in the 15. call parameter
FEh, FFh			Profile-specific error

15 Standard

Block library "Standard"

The block library can be found for download in the 'Service/Support' area of www.vipa.com at 'Downloads → VIPA Lib' as 'Block library Standard - SW90JS0MA'. The library is available as packed zip file. As soon as you want to use these blocks you have to import them into your project. ↪ [Chap. 5 'Include VIPA library' page 69](#)

15.1 Converting

15.1.1 FB 80 - LEAD_LAG - Lead/Lag Algorithm

Description

The Lead/Lag Algorithm LEAD_LAG function block allows signal processing to be done on an analog variable. An output *OUT* is calculated based on an input *IN* and the specified gain *GAIN*, lead *LD_TIME*, and lag *LG_TIME* values. The gain value must be greater than zero. The LEAD_LAG algorithm uses the following equation:

$$\text{and } OUT = \left[\frac{LG_TIME}{LG_TIME + SAMPLE_T} \right] PREV_OUT + GAIN \left[\frac{LD_TIME + SAMPLE_T}{LG_TIME + SAMPLE_T} \right] IN - GAIN \left[\frac{LD_TIME}{LG_TIME + SAMPLE_T} \right] PREV_IN$$

Typically, LEAD_LAG is used in conjunction with loops as a compensator in dynamic feed-forward control. LEAD_LAG consists of two parts. Phase lead shifts the phase of the function block's output so that it leads the input whereas phase lag shifts the output so that it lags the input. Because the lag operation is equivalent to an integration, it can be used as a noise suppressor or a low-pass filter. A lead operation is equivalent to a differentiation and is thus a high-pass filter. LEAD_LAG combined can cause the output phase to lag input at low frequency, and to lead input at high frequency, and can thus be used as a band-pass filter.

Parameters

Parameter	Declaration	Data Type	Memory Area	Description
EN	Input	BOOL	I, Q, M, D, L	Enable input with signal state of 1 activates the box
ENO	Output	BOOL	I, Q, M, D, L	Enable output has a signal state of 1 if the function block is executed without error
IN	Input	REAL	I, Q, M, D, L, P, constant	The input value of the current sample period to be processed
SAMPLE_T	Output	INT	I, Q, M, D, L, P, constant	Sample time
OUT	Output	REAL	I, Q, M, D, L, P, constant	The result of the LEAD_LAG operation
ERR_CODE	Output	WORD	I, Q, M, D, L, P	Returns a value of W#16#0000 if the instruction executes without error; see Error Information for values other than W#16#0000
LD_TIME	Static	REAL	I, Q, M, D, L, P, constant	Lead time in minutes
LG_TIME	Static	REAL	I, Q, M, D, L, P, constant	Lag time in minutes
GAIN	Static	REAL	I, Q, M, D, L, P, constant	Gain as % / % (the ratio of the change in output to the change in input as a steady state).

Parameter	Declaration	Data Type	Memory Area	Description
PREV_IN	Static	REAL	I, Q, M, D, L, P, constant	Previous input
PREV_OUT	Static	REAL	I, Q, M, D, L, P, constant	Previous output

Error Information

If *GAIN* is less than or equal to 0, the function block is not executed. The signal state of *ENO* is set to 0 and *ERR_CODE* is set equal to W#16#0009.

15.1.2 FC 93 - SEG - Seven Segment Decoder**Description**

The Seven Segment Decoder SEG function converts each of the four hexadecimal digits in the designated source data word *IN* into four equivalent 7-segment display codes and writes it to the output destination double word *OUT*. The Figure below shows the relationship between the input hex digits and the output bit patterns.

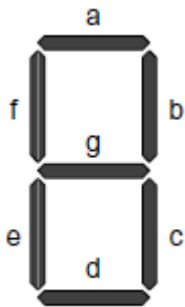
**Parameters**

Digit	- g f e d c b a	Display
0 0 0 0	0 0 1 1 1 1 1 1	0
0 0 0 1	0 0 0 0 0 1 1 0	1
0 0 1 0	0 1 0 1 1 0 1 1	2
0 0 1 1	0 1 0 0 1 1 1 1	3
0 1 0 0	0 1 1 0 0 1 1 0	4
0 1 0 1	0 1 1 0 1 1 0 1	5
0 1 1 0	0 1 1 1 1 1 0 1	6
0 1 1 1	0 0 0 0 0 1 1 1	7
1 0 0 0	0 1 1 1 1 1 1 1	8
1 0 0 1	0 1 1 0 0 1 1 1	9
1 0 1 0	0 1 1 1 0 1 1 1	A
1 0 1 1	0 1 1 1 1 1 0 0	b
1 1 0 0	0 0 1 1 1 0 0 1	C
1 1 0 1	0 1 0 1 1 1 1 0	d
1 1 1 0	0 1 1 1 1 0 0 1	E
1 1 1 1	0 1 1 1 0 0 0 1	F

Parameters

Parameter	Declaration	Data Type	Memory Area	Description
EN	Input	BOOL	I, Q, M, D, L	Enable input with signal state of 1 activates the box
ENO	Output	BOOL	I, Q, M, D, L	Enable output has a signal state of 1 if the function is executed without error

Parameter	Declaration	Data Type	Memory Area	Description
IN	Input	WORD	I, M, D, P, or constant	Source data word in four hexadecimal digits
OUT	Output	DWORD	Q, M, D, L, P	Destination bit pattern in four bytes

Error Information This function does not detect any error conditions.

15.1.3 FC 94 - ATH - ASCII to Hex

Description The ASCII to Hex (ATH) function converts the ASCII character string pointed to by *IN* into packed hexadecimal digits and stores these in the destination table pointed to by *OUT*. Since 8 bits are required for the ASCII character and only 4 bits for the hexadecimal digit, the output word length is only half of the input word length. The ASCII characters are converted and placed into the hexadecimal output in the same order as they are read in. If there is an odd number of ASCII characters, the hexadecimal digit is padded with zeros in the right-most nibble of the last converted hexadecimal digit.

Parameters

Parameter	Declaration	Data Type	Memory Area	Description
EN	Input	BOOL	I, Q, M, D, L	Enable input with signal state of 1 activates the box
ENO	Output	BOOL	I, Q, M, D, L	Enable output has a signal state of 1 if the function is executed without error
IN	Input	Pointer*	I, Q, M, D, L	Points to the starting location of an ASCII string
N	Input	INT	I, Q, M, L, P	Number of ASCII input characters to be converted
RET_VAL	Output	WORD	I, Q, M, D, L, P	Returns a value of W#16#0000 if the instruction executes without error; see Error Information for values other than W#16#0000
OUT	Output	Pointer*	Q, M, D, L	Points to the starting location of the table

*) Double word pointer format for area-crossing register indirect addressing

Error Information If any ASCII character is found to be invalid, it is converted as 0. The signal state of *ENO* is set to 0 and *RET_VAL* is set equal to W#16#0007.

15.1.4 FC 95 - HTA - Hex to ASCII

Description The Hex to ASCII (HTA) function converts packed hexadecimal digits, pointed to by *IN*, and stores them in the destination string pointed to by *OUT*. Since 8 bits are required for the character and only 4 bits for the hex digit, the output word length is two times that of the input word length. Each nibble of the hexadecimal digit is converted into a character in the same order as they are read in (left-most nibble of a hexadecimal digit is converted first, followed by the right-most nibble of that same digit).

Parameters

Parameter	Declaration	Data Type	Memory Area	Description
EN	Input	BOOL	I, Q, M, D, L	Enable input with signal state of 1 activates the box
ENO	Output	BOOL	I, Q, M, D, L	Enable output has a signal state of 1 if the function is executed without error
IN	Input	Pointer *	I, Q, M, D	Points to the starting location of the hexadecimal digit string
N	Input	WORD	I, Q, M, L, P	Number of hex input bytes to be converted
OUT	Output	Pointer *	Q, M, D, L	Points to the starting location of the destination table

*) Double word pointer format for area-crossing register indirect addressing

Error Information This function does not detect any error conditions.

15.1.5 FC 96 - ENCO - Encode Binary Position**Description**

The Encode Binary Position ENCO function converts the contents of *IN* to the 5-bit binary number corresponding to the bit position of the right-most set bit in *IN* and returns the result as the function's value. If *IN* is either 0000 0001 or 0000 0000, a value of 0 is returned.

Parameters

Parameter	Declaration	Data Type	Memory Area	Description
EN	Input	BOOL	I, Q, M, D, L	Enable input with signal state of 1 activates the box
ENO	Output	BOOL	I, Q, M, D, L	Enable output has a signal state of 1 if the function is executed without error
IN	Input	DWORD	I, M, D, L, P, or constant	Value to be encoded
RET_VAL	Input	INT	Q, M, D, L, P	Value returned (contains 5-bit binary number)

Error Information This function does not detect any error conditions.

15.1.6 FC 97 - DECO - Decode Binary Position**Description**

The Decode Binary Position DECO function converts a 5-bit binary number (0 – 31) from input *IN* to a value by setting the corresponding bit position in the function's return value. If *IN* is greater than 31, a modulo 32 operation is performed to get a 5-bit binary number.

Parameters

Parameter	Declaration	Data Type	Memory Area	Description
EN	Input	BOOL	I, Q, M, D, L	Enable input with signal state of 1 activates the box
ENO	Output	BOOL	I, Q, M, D, L	Enable output has a signal state of 1 if the function is executed without error
IN	Input	WORD	I, M, D, L, P, constant	Variable to decode
RET_VAL	Output	DWORD	Q, M, D, L, P	Value returned

Error Information This function does not detect any error conditions.

15.1.7 FC 98 - BCDCPL - Tens Complement

Description The Tens Complement BCDCPL function returns the Tens complement of a 7-digit BCD number *IN*. The mathematical formula for this operation is the following:

$$10000000 \text{ (in BCD)} - 7\text{digit BCD value} = \text{Tens complement value (in BCD)}$$

Parameters

Parameter	Declaration	Data Type	Memory Area	Description
EN	Input	BOOL	I, Q, M, D, L	Enable input with signal state of 1 activates the box
ENO	Output	BOOL	I, Q, M, D, L	Enable output has a signal state of 1 if the function is executed without error
IN	Input	DWORD	I, M, D, L, P, constant	7-digit BCD number
RET_VAL	Output	DWORD	Q, M, D, L, P	Value returned

Error Information This function does not detect any error conditions.

15.1.8 FC 99 - BITSUM - Sum Number of Bits

Description The Sum Number of Bits BITSUM function counts the number of bits that are set to a value of 1 in the input *IN* and returns this as the function's value.

Parameter

Parameter	Deklaration	Datentyp	Speicherbereich	Beschreibung
EN	Input	BOOL	I, Q, M, D, L	Enable input with signal state of 1 activates the box
ENO	Output	BOOL	I, Q, M, D, L	Enable output has a signal state of 1 if the function is executed without error
IN	Input	DWORD	I, M, D, L, P, constant	Variable to count bits in
RET_VAL	Output	INT	Q, M, D, L, P	Value returned

Error Information This function does not detect any error conditions.

15.1.9 FC 105 - SCALE - Scaling Values

Description

The Scaling Values SCALE function takes an integer value *IN* and converts it to a real value in engineering units scaled between a low and a high limit *LO_LIM* and *HI_LIM*. The result is written to *OUT*. The SCALE function uses the equation:

$$OUT = [((FLOAT (IN) - K1) / (K2 - K1)) \cdot (HI_LIM - LO_LIM)] + LO_LIM$$

The constants *K1* and *K2* are set based upon whether the input value is *BIPOLAR* or *UNIPOLAR*.

- **BIPOLAR:**
 - The input integer value is assumed to be between -27648 and 27648, therefore, *K1* = -27648,0 and *K2* = +27648,0.
- **UNIPOLAR:**
 - The input integer value is assumed to be between 0 and 27648, therefore, *K1* = 0,0 and *K2* = +27648,0.

If the input integer value is greater than *K2*, the output *OUT* is clamped to *HI_LIM*, and an error is returned. If the input integer value is less than *K1*, the output *OUT* is clamped to *LO_LIM*, and an error is returned. Reverse scaling can be obtained by programming *LO_LIM* > *HI_LIM*. With reverse scaling, the value of the output decreases as the value of the input increases.

Parameters

Parameter	Declaration	Data Type	Memory Area	Description
EN	INPUT	BOOL	I, Q, M, D, L	<ul style="list-style-type: none"> ■ Enable <ul style="list-style-type: none"> – TRUE: activates the function – FALSE: deactivates the function
ENO	OUTPUT	BOOL	I, Q, M, D, L	<ul style="list-style-type: none"> ■ Status <ul style="list-style-type: none"> – TRUE: function executed without error
IN	INPUT	INT	I, Q, M, D, L, constant	The input value to be scaled to a REAL value in engineering units
HI_LIM	INPUT	REAL	I, Q, M, D, L, P, constant	Upper limit in engineering units
LO_LIM	INPUT	REAL	I, Q, M, D, L, P, constant	Lower limit in engineering units
BIPOLAR	INPUT	BOOL	I, Q, M, D, L	A signal state of 1 indicates the input value is bipolar, a signal state of "0" indicates unipolar
OUT	OUTPUT	REAL	I, Q, M, D, L, P	The result of the scale conversion
RET_VAL	INPUT	WORD	I, Q, M, D, L, P	Returns a value of W#16#0000 if the instruction executes without error; see Error Information for values other than W#16#0000

Error information

- If the input integer value is greater than K2, the output *OUT* is clamped to *HI_LIM*, and an error is returned.
- If the input integer value is less than K1, the output *OUT* is clamped to *LO_LIM*, and an error is returned.
- The signal state of *ENO* is set to FALSE and *RET_VAL* is set equal to W#16#0008.

15.1.10 FC 106 - UNSCALE - Unscaling Values**Description**

The Unscaling Values UNSCALE function takes a real input value *IN* in engineering units scaled between a low and a high limit *LO_LIM* and *HI_LIM* and converts it to an integer value. The result is written to *OUT*. The UNSCALE function uses the equation:

$$OUT = [((IN - LO_LIM) / (HI_LIM - LO_LIM)) \cdot (K2 - K1)] + K1$$

and sets the constants K1 and K2 based upon whether the input value is *BIPOLAR* or *UNIPOLAR*.

- *BIPOLAR*:
 - The input integer value is assumed to be between -27648 and 27648, therefore, K1 = -27648.0 and K2 = +27648.0.
- *UNIPOLAR*:
 - The input integer value is assumed to be between 0 and 27648, therefore, K1 = 0.0 and K2 = +27648.0.

If the input value is outside the *LO_LIM* and *HI_LIM* range, the output *OUT* is clamped to the nearer of either the low limit or the high limit of the specified range for its type (*BIPOLAR* or *UNIPOLAR*), and an error is returned.

Parameters

Parameter	Declaration	Data Type	Memory Area	Description
EN	Input	BOOL	I, Q, M, D, L	<ul style="list-style-type: none"> ■ Enable <ul style="list-style-type: none"> – TRUE: activates the function – FALSE: deactivates the function
ENO	Output	BOOL	I, Q, M, D, L	<ul style="list-style-type: none"> ■ Status <ul style="list-style-type: none"> – TRUE: function executed without error
IN	Input	REAL	I, Q, M, D, L, P, constant	The input value to be unscaled to an integer value
HI_LIM	Input	REAL	I, Q, M, D, L, P, constant	Upper limit in engineering units
LO_LIM	Input	REAL	I, Q, M, D, L, P, constant	Lower limit in engineering units
BIPOLAR	Input	BOOL	I, Q, M, D, L	A signal state of 1 indicates the input value is bipolar and a signal state of "0" indicates unipolar
OUT	Output	INT	I, Q, M, D, L, P	The result of the scale conversion
RET_VAL	Output	WORD	I, Q, M, D, L, P	Returns a value of W#16#0000 if the instruction executes without error; see Error Information for values other than W#16#0000

Error Information

If the input real value is outside the *LO_LIM* and *HI_LIM* range the output *OUT* is clamped to the nearer of either the low limit or the high limit of the specified range for its type (*BIPOLAR* or *UNIPOLAR*), and an error is returned. The signal state of *ENO* is set to 0 and *RET_VAL* is set equal to *W#16#0008*.

15.1.11 FC 108 - RLG_AA1 - Issue an Analog Value**Description**

The function *RLG_AA1* (Issue an Analog Value) transforms an Input Value *XE* (Fixed Point Number) into an output value for an analog output module in accordance with the nominal range between *OGR* and *UGR*. If the nominal range is exceeded, an error message is displayed.

Parameter	Datentyp	Speicherbereich	Beschreibung
<i>XE</i>	INT	I, Q, M, L, D, constant	Input value <i>XE</i> as a fixed point number
<i>BG</i>	INT	I, Q, M, L, D, constant	Specify the module address
<i>KNKT</i>	WORD	I, Q, M, L, D, constant	Channel number <i>KN</i> Channel type <i>KT</i>
<i>OGR</i>	INT	I, Q, M, L, D, constant	Upper limit of the input value <i>XE</i>
<i>UGR</i>	INT	I, Q, M, L, D, constant	Lower limit of the input value <i>XE</i>
<i>FEH</i>	BOOL	I, Q, M, L, D	Error bit
<i>BU</i>	BOOL	I, Q, M, L, D	Range excess

Differences between S5 and S7

- The *BG* parameter
 - There is no address check. The range is the whole P area.



This function is only used to convert the FB251 of an existing S5 program of an S5 CPU 941 to 944 to a function of an S7 program for the S7-400 programmable controller.

15.1.12 FC 109 - RLG_AA2 - Write Analog Value 2**Description**

The function *RLG_AA2* (Issue an Analog Value) transforms an Input Value *XE* (Floating Point Number) into an output value for an analog output module in accordance with the nominal range between *OGR* and *UGR*. If the nominal range is exceeded, an error message is displayed.

Parameter	Data Type	Memory Area	Description
<i>XE</i>	REAL	I, Q, M, L, D, constant	Input value <i>XE</i> as a floating point number
<i>BG</i>	INT	I, Q, M, L, D, constant	Specify the module address
<i>P_Q</i>	WORD	I, Q, M, L, D, constant	Peripheriebereich normal/erweitert

Parameter	Data Type	Memory Area	Description
KNKT	WORD	I, Q, M, L, D, constant	Channel number KN Channel type KT
OGR	REAL	I, Q, M, L, D, constant	Upper limit of the input value <i>XE</i>
UGR	REAL	I, Q, M, L, D, constant const.	Lower limit of the input value <i>XE</i>
FEH	BOOL	I, Q, M, L, D	Error bit
BU	BOOL	I, Q, M, L, D	Range excess

Differences between S5 and S7

- The BG parameter
 - There is no address check. The range is the whole P area.
- In S7, no value is assigned to the parameter *P_Q*.
- A process image of the S5 I/O areas P/Q/IM3/IM4 is made in the S7 I/O area. You must assign the I/O area in the configuration table.



This function is only used to convert the FB41 of an existing S5 program of an S5 CPU 928B, 945 or 948 to a function of an S7 program for the S7-400 programmable controller.

15.1.13 FC 110 - PER_ET1 - Read/Write Ext. Per. 1

Description

The function PER_ET1 (Reading and Writing for Expanded Peripherals) transfers either a peripheral area into a CPU-internal area or vice-versa (depending on the parameter assignment). In this way, input bytes can be read from, and output bytes written to, the expanded I/O. If a data block is selected as an internal area, the block must have been set up by the user with the necessary length prior to calling up the function.

Parameter	Data Type	Memory Area	Description
PBIB	WORD	I, Q, M, L, D, constant	Specify the areas to be processed
ANF	INT	I, Q, M, L, D, constant	Beginning of the internal area
ANEN	WORD	I, Q, M, L, D, constant	Beginning and end of the block on the interface module
E_A	BOOL	I, Q, M, L, D, constant	Transfer direction
PAFE	BOOL	I, Q, M, L, D	Parameter assignment error

Differences between S5 and S7

- The *PBIB* parameter
 - In S7, the I/O area is assigned values as follows:

	S5		S7
P area	0 to 255	P area	0 to 255
Q area	0 to 255	P area	256 to 511

Converting > FC 111 - PER_ET2 - Read/Write Ext. Per. 2

IM3 area	0 to 255	P area	512 to 767
IM4 area	0 to 255	P area	768 to 1023
DB	0 to 255	DB	0 to 255
DX	0 to 255	DB	256 to 511
M	0 to 199	M	0 to 199
S		Error message: "Invalid range"	

- A process image of the S5 I/O areas P/Q/IM3/IM4 is made in the S7 I/O area. You must assign the I/O area in the configuration table.



This function is only used to convert the FB196 of an existing S5 program of an S5 CPU 95U, 103, 941 to 944, 945, 928B, 948 to a function of an S7 program for the S7-300/400 programmable controller.

15.1.14 FC 111 - PER_ET2 - Read/Write Ext. Per. 2

Description

The function PER_ET2 (Reading and Writing for Expanded Peripheries) transfers either a peripheral area into a CPU-internal area or vice-versa (depending on the parameter assignment). In this way, input bytes can be read from, and output bytes written to, the expanded I/O. If a data block is selected as an internal area, the block must have been set up by the user with the necessary length prior to calling up the function.

Differences between S5 and S7:

- The *PBIB* parameter (defined in DB)
 - In S7, the I/O area is assigned values as follows:

	S5		S7
P area	0 to 255	P area	0 to 255
Q area	0 to 255	P area	256 to 511
IM3 area	0 to 255	P area	512 to 767
IM4 area	0 to 255	P area	768 to 1023
DB	0 to 255	DB	0 to 255
DX	0 to 255	DB	256 to 511
M	0 to 199	M	0 to 199
S		Error message: "Invalid range"	

- A process image of the S5 I/O areas P/Q/IM3/IM4 is made in the S7 I/O area. You must assign the I/O area in the configuration table.



This function is only used to convert the FB197 of an existing S5 program of an S5 CPU 95U, 103, 941 to 944, 945, 928B, 948 to a function of an S7 program for the S7-300/400 programmable controller.

15.2 IEC

15.2.1 Date and time as complex data types

Actual parameters for DATE_AND_TIME

The DATE_AND_TIME data type is a complex data type like ARRAY, STRING, and STRUCT. The permissible memory areas for complex data types are the data block (DB) and local data (L stack) areas. If you use the data type DATE_AND_TIME as formal parameter in an instruction, due to the complex data type you can specify only one of the following formats:

- A block-specific symbol from the variable declaration table for a specific block
- A symbolic name for a data block, such as e.g. "DB_sys_info.System_Time", made up of the following parts:
 - A name defined in the symbol table for the number of the data block (e.g. "DB_sys_info" for DB 5)
 - A name defined within the data block for the DATE_AND_TIME element (e.g. "Time" for a variable of data type DATE_AND_TIME contained in DB 5)



You cannot pass constants as actual parameters to formal parameters of the complex data types, including DATE_AND_TIME. Also, you cannot pass absolute addresses as actual parameters to DATE_AND_TIME.

15.2.2 FC 1 - AD_DT_TM - Add duration to instant of time

Description

The function FC 1 adds a duration D (time) to an instant of time T (date and time) and provides a new instant of time (date and time) as the result. The instant of time T must be in the range DT#1990-01-01-00:00:00.000 ... DT#2089-12-31-23:59:59.999. The function does not check the input parameters. If the result of the addition is not within the valid range, the result is limited to the corresponding value and the binary result (BR) bit of the status word is set to "0".

Parameter

Parameter	Declaration	Data type	Memory area	Description
T*	INPUT	DATE_AND_TIME	D, L	Instant of time in format DT
D	INPUT	TIME	I, Q, M, D, L Constant	Duration in Format TIME
RET_VAL*	OUTPUT	DATE_AND_TIME	D, L	Sum in format DT

*) You can assign only a symbolically defined variable for the parameter.

15.2.3 FC 2 - CONCAT - Concatenate two STRING variables

Description

The function FC 2 concatenates two STRING variables together to form one string. If the resulting string is longer than the variable given at the output parameter, the result string is limited to the maximum set length and the BR bit is set to "0".

IEC > FC 4 - DELETE - Delete in a STRING variable

Parameter

Parameter	Declaration	Data type	Memory area	Description
IN1*	INPUT	STRING	D, L	Input variable in format STRING
IN2*	INPUT	STRING	D, L	Input variable in format STRING
RET_VAL*	OUTPUT	STRING	D, L	Concatenated string

*) You can assign only a symbolically defined variable for the parameter.

15.2.4 FC 3 - D_TOD_DT - Combine DATE and TIME_OF_DAY

Description

The function FC 3 combines the data formats DATE and TIME_OF_DAY (TOD) and converts these formats to the data format DATE_AND_TIME (DT). The input value *IN1* must be in the range DATE#1990-01-01 ... DATE#2089-12-31. The function does not check the input parameters and does not report any errors.

Parameter

Parameter	Declaration	Data type	Memory area	Description
IN1	INPUT	DATE	I, Q, M, D, L Constant	Input variable in format DATE
IN2	INPUT	TIME_OF_DAY	I, Q, M, D, L Constant	Input variable in format TOD
RET_VAL*	OUTPUT	DATE_AND_TIME	D, L	Return value in format DT

*) You can assign only a symbolically defined variable for the parameter.

15.2.5 FC 4 - DELETE - Delete in a STRING variable

Description

The function FC 4 deletes a number of characters *L* from the character at position *P* (inclusive) in a string. The function does not report any errors.

- If *L* and/or *P* are equal to zero or if *P* is greater than the current length of the input string, the input string is returned.
- If the sum of *L* and *P* is greater than the input string, the string is deleted up to the end.
- If *L* and/or *P* is negative, a blank string is returned and the BR bit is set to "0".

Parameter

Parameter	Declaration	Data type	Memory area	Description
IN*	INPUT	STRING	D, L	STRING variable to be deleted in
L	INPUT	INT	I, Q, M, D, L Constant	Number of characters to be deleted
P	INPUT	INT	I, Q, M, D, L Constant	Position of 1. character to be deleted

Parameter	Declaration	Data type	Memory area	Description
RET_VAL*	OUTPUT	STRING	D, L	Result string

*) You can assign only a symbolically defined variable for the parameter.

15.2.6 FC 5 - DI_STRNG - Convert DINT to STRING

Description The function FC 5 converts a variable in DINT data format to a string. The string is shown preceded by a sign. If the variable given at the return parameter is too short, no conversion takes place and the BR bit is set to "0".

Parameter

Parameter	Declaration	Data type	Memory area	Description
I	INPUT	DINT	I, Q, M, D, L Constant	Input value
RET_VAL*	OUTPUT	STRING	D, L	Result string

*) You can assign only a symbolically defined variable for the parameter.

15.2.7 FC 6 - DT_DATE - Extract DATE from DT

Description The function FC 6 extracts the data format DATE from the format DATE_AND_TIME. DATE value is between the limits DATE#1990-1-1 and DATE#2089-12-31. The function does not report any errors.

Parameter

Parameter	Declaration	Data type	Memory area	Description
IN*	INPUT	DATE_AND_TIME	D, L	Input variable in format DT
RET_VAL	OUTPUT	DATE	I, Q, M, D, L	Return value in format DATE

*) You can assign only a symbolically defined variable for the parameter.

15.2.8 FC 7 - DT_DAY - Extract day of the week from DT

Description The function FC 7 extracts the day of the week from the format DATE_AND_TIME. The function does not report any errors. The day of the week is returned as INTEGER value.

- 1: Sunday
- 2: Monday
- 3: Tuesday
- 4: Wednesday
- 5: Thursday
- 6: Friday
- 7: Saturday

Parameter

IEC > FC 10 - EQ_STRNG - Compare STRING for equal

Parameter	Declaration	Data type	Memory area	Description
IN*	INPUT	DATE_AND_TIME	D, L	Input variable in format DT
RET_VAL	OUTPUT	INT	I, Q, M, D, L	Return value in format INT

*) You can assign only a symbolically defined variable for the parameter.

15.2.9 FC 8 - DT_TOD - Extract TIME_OF_DAY from DT

Description

The function FC 8 extracts the data format TIME_OF_DAY from the format DATE_AND_TIME. The function does not report any errors.

Parameter

Parameter	Declaration	Data type	Memory area	Description
IN*	INPUT	DATE_AND_TIME	D, L	Input variable in format DT
RET_VAL	OUTPUT	TIME_OF_DAY	I, Q, M, D, L	Return value in format TOD

*) You can assign only a symbolically defined variable for the parameter.

15.2.10 FC 9 - EQ_DT - Compare DT for equality

Description

The function FC 9 compares the contents of two variables in the data type format DATE_AND_TIME to determine if they are equal and outputs the result of the comparison as a return value. The return value has the signal state "1" if the time at parameter DT1 is the same as the time at parameter DT2. The function does not report any errors.

Parameter

Parameter	Declaration	Data type	Memory area	Description
DT1*	INPUT	DATE_AND_TIME	D, L	Input variable in format TD
DT2*	INPUT	DATE_AND_TIME	D, L	Input variable in format TD
RET_VAL	OUTPUT	BOOL	I, Q, M, D, L	Comparison result

*) You can assign only a symbolically defined variable for the parameter.

15.2.11 FC 10 - EQ_STRNG - Compare STRING for equal

Description

The function FC 10 compares the contents of two variables in the format STRING to determine if they are equal and outputs the result of the comparison as a return value. The return value has the signal state "1" if the string at parameter S1 is the same as the string at parameter S2. The function does not report any errors.

Parameter

Parameter	Declaration	Data type	Memory area	Description
S1*	INPUT	STRING	D, L	Input variable in format STRING
S2*	INPUT	STRING	D, L	Input variable in format STRING

Parameter	Declaration	Data type	Memory area	Description
RET_VAL	OUTPUT	BOOL	I, Q, M, D, L	Comparison result

*) You can assign only a symbolically defined variable for the parameter.

15.2.12 FC 11 - FIND - Find in a STRING variable

Description

The function FC 11 provides the position of the second string *IN2* within the first string *IN1*. The search starts on the left; the first occurrence of the string is reported. If the second string is not found in the first, zero is returned. The function does not report any errors.

Parameter

Parameter	Declaration	Data type	Memory area	Description
IN1*	INPUT	STRING	D, L	STRING variable to be searched in
IN2*	INPUT	STRING	D, L	STRING variable to be found
RET_VAL	OUTPUT	INT	I, Q, M, D, L	Position of the string found

*) You can assign only a symbolically defined variable for the parameter.

15.2.13 FC 12 - GE_DT - Compare DT for greater than or equal

Description

The function FC 12 compares the contents of two variables in the data format DATE_AND_TIME to determine if one is greater or equal to the other and outputs the result of the comparison as a return value. The return value has the signal state "1" if the time at parameter *DT1* is greater (younger) than the time at parameter *DT2* or if both instants of time are the same. The function does not report any errors.

Parameter

Parameter	Declaration	Data type	Memory area	Description
DT1*	INPUT	DATE_AND_TIME	D, L	Input variable in format TD
DT2*	INPUT	DATE_AND_TIME	D, L	Input variable in format TD
RET_VAL	OUTPUT	BOOL	I, Q, M, D, L	Comparison result

*) You can assign only a symbolically defined variable for the parameters.

15.2.14 FC 13 - GE_STRNG - Compare STRING for greater than or equal

Description

The function FC 13 compares the contents of two variables in the data format STRING to determine if one is greater or equal to the other and outputs the result of the comparison as a return value. The return value has the signal state "1" if the string at parameter *S1* is greater than or equal to the string at parameter *S2*. The characters are compared by their ASCII code (e.g. 'a' is greater than 'A'), starting from the left. The first character to be different decides the result of the comparison. If the left part of the longer string is identical to the shorter string, the longer string is considered as greater. The function does not report any errors.

IEC > FC 15 - GT_STRNG - Compare STRING for greater than

Parameter

Parameter	Declaration	Data type	Memory area	Description
S1*	INPUT	STRING	D, L	Input variable in format STRING
S2*	INPUT	STRING	D, L	Input variable in format STRING
RET_VAL	OUTPUT	BOOL	I, Q, M, D, L	Comparison result

*) You can assign only a symbolically defined variable for the parameter.

15.2.15 FC 14 - GT_DT - Compare DT for greater than**Description**

The function FC 14 compares the contents of two variables in the data format DATE_AND_TIME to determine if one is greater to the other and outputs the result of the comparison as a return value. The return value has the signal state "1" if the time at parameter DT1 is greater (younger) than the time at parameter DT2. The function does not report any errors.

Parameter

Parameter	Declaration	Data type	Memory area	Description
DT1*	INPUT	DATE_AND_TIME	D, L	Input variable in format TD
DT2*	INPUT	DATE_AND_TIME	D, L	Input variable in format TD
RET_VAL	OUTPUT	BOOL	I, Q, M, D, L	Comparison result

*) You can assign only a symbolically defined variable for the parameter.

15.2.16 FC 15 - GT_STRNG - Compare STRING for greater than**Description**

The function FC 15 compares the contents of two variables in the data format STRING to find out if the first is greater than the other and outputs the result of the comparison as a return value. The return value has the signal state "1" if the string at parameter S1 is greater than the string at parameter S2. The characters are compared by their ASCII code (e.g. 'a' is greater than 'A'), starting from the left. The first character to be different decides the result of the comparison. If the left part of the longer string is identical to the shorter string, the longer string is considered as greater. The function does not report any errors.

Parameter

Parameter	Declaration	Data type	Memory area	Description
S1*	INPUT	STRING	D, L	Input variable in format STRING
S2*	INPUT	STRING	D, L	Input variable in format STRING
RET_VAL	OUTPUT	BOOL	I, Q, M, D, L	Comparison result

*) You can assign only a symbolically defined variable for the parameter.

15.2.17 FC 16 - I_STRNG - Convert INT to STRING

Description

The function FC 16 converts a variable in DINT data format to a string. The string is shown preceded by a sign. If the variable given at the return parameter is too short, no conversion takes place and the BR bit is set to "0".

Parameter

Parameter	Declaration	Data type	Memory area	Description
I	INPUT	INT	I, Q, M, D, L Constant	Input value
RET_VAL*	OUTPUT	STRING	D, L	Result string

*) You can assign only a symbolically defined variable for the parameter.

15.2.18 FC 17 - INSERT - Insert in a STRING variable

Description

The function FC 17 inserts a string at parameter *IN2* into the string at parameter *IN1* after the character at position *P*.

- If *P* equals zero, the second string is inserted before the first string.
- If *P* is greater than the current length of the first string, the second string is appended to the first.
- If *P* is negative, a blank string is output and the BR bit is set to "0". The binary result bit is also set to "0" if the resulting string is longer than the variable given at the output parameter; in this case the result string is limited to the maximum set length.

Parameter

Parameter	Declaration	Data type	Memory area	Description
IN1*	INPUT	STRING	D, L	STRING variable to be inserted into
IN2*	INPUT	STRING	D, L	STRING variable to be inserted
P	INPUT	INT	I, Q, M, D, L Constant	Insert position
RET_VAL*	OUTPUT	STRING	D, L	Result string

*) You can assign only a symbolically defined variable for the parameter.

15.2.19 FC 18 - LE_DT - Compare DT for smaller than or equal

Description

The function FC 18 compares the contents of two variables in the format DATE_AND_TIME to determine if one is smaller or equal to the other and outputs the result of the comparison as a return value. The return value has the signal state "1" if the time at parameter *DT1* is smaller (older) than the time at parameter *DT2* or if both instants of time are the same. The function does not report any errors.

Parameter

IEC > FC 20 - LEFT - Left part of a STRING variable

Parameter	Declaration	Data type	Memory area	Description
DT1*	INPUT	DATE_AND_TIME	D, L	Input variable in format TD
DT2*	INPUT	DATE_AND_TIME	D, L	Input variable in format TD
RET_VAL*	OUTPUT	BOOL	I, Q, M, D, L	Comparison result

*) You can assign only a symbolically defined variable for the parameter.

15.2.20 FC 19 - LE_STRNG - Compare STRING for smaller then or equal

Description

The function FC 19 compares the contents of two variables in the format STRING to determine if one is smaller or equal to the other and outputs the result of the comparison as a return value. The return value has the signal state "1" if the string at parameter S1 is smaller than or equal to the string at parameter S2. The characters are compared by their ASCII code (e.g. 'A' smaller than 'a'), starting from the left. The first character to be different decides the result of the comparison. If the left part of the longer character string and the shorter character string are the same, the shorter string is smaller. The function does not report any errors.

Parameter

Parameter	Declaration	Data type	Memory area	Description
S1*	INPUT	STRING	D, L	Input variable in format STRING
S2*	INPUT	STRING	D, L	Input variable in format STRING
RET_VAL	OUTPUT	BOOL	I, Q, M, D, L	Comparison result

*) You can assign only a symbolically defined variable for the parameter.

15.2.21 FC 20 - LEFT - Left part of a STRING variable

Description

The function FC 20 provides the first L characters of a string.

- If L is greater than the current length of the STRING variable, the input value is returned.
- With $L = 0$ and with a blank string as the input value, a blank string is returned.
- If L is negative, a blank string is returned and the BR bit of the status word is set to "0".

Parameter

Parameter	Declaration	Data type	Memory area	Description
IN*	INPUT	STRING	D, L	Input variable in format STRING
L	INPUT	INT	I, Q, M, D, L Constant	Length of the left character string
RET_VAL*	OUTPUT	STRING	D, L	Output variable in format STRING

*) You can assign only a symbolically defined variable for the parameter.

15.2.22 FC 21 - LEN - Length of a STRING variable

Description

A STRING variable contains two lengths:

- Maximum length
 - It is given in square brackets when the variables are being defined.
- Current length
 - This is the number of currently valid characters.

The current length is smaller or equal to the maximum length. The number of bytes occupied by a string is 2 greater than the maximum length. The function FC 21 outputs the current length of a string (number of valid characters) as a return value. A blank string (' ') has the length zero. The maximum length is 254. The function does not report any errors.

Parameter

Parameter	Declaration	Data type	Memory area	Description
S*	INPUT	STRING	D, L	Input variable in format STRING
RET_VAL	OUTPUT	INT	I, Q, M, D, L	Number of current characters

*) You can assign only a symbolically defined variable for the parameter.

15.2.23 FC 22 - LIMIT

Description

The function FC 22 limits the number value of a variable to limit values which can have parameters assigned.

- Variables of the data types INT, DINT, and REAL are permitted as input values.
- All variables with parameters assigned must be of the same data type.
- The variable type is recognized by the ANY pointer.
- *MN* may not be greater as *MX*.
- The output value remains unchanged and the BR bit is set to "0" if:
 - a variable with parameters assigned has an invalid data type.
 - all variables with parameters assigned do not have the same data type.
 - the lower limit value is greater than the upper limit value.
 - a REAL variable does not represent a valid floating-point number.

Parameter

Parameter	Declaration	Data type	Memory area	Description
MN	INPUT	ANY	I, Q, M, D, L	Lower limit
IN	INPUT	ANY	I, Q, M, D, L	Input variable
MX	INPUT	ANY	I, Q, M, D, L	Upper limit
RET_VAL	OUTPUT	ANY	I, Q, M, D, L	Limited output variable

15.2.24 FC 23 - LT_DT - Compare DT for smaller than

Description

The function FC 23 compares the contents of two variables in the format DATE_AND_TIME to determine if one is smaller to the other and outputs the result of the comparison as a return value. The return value has the signal state "1" if the time at parameter *DT1* is smaller (older) than the time at parameter *DT2*. The function does not report any errors.

Parameter

Parameter	Declaration	Data type	Memory area	Description
DT1*	INPUT	DATE_AND_TIME	D, L	Input variable in format TD
DT2*	INPUT	DATE_AND_TIME	D, L	Input variable in format TD
RET_VAL	OUTPUT	BOOL	I, Q, M, D, L	Comparison result

*) You can assign only a symbolically defined variable for the parameter.

15.2.25 FC 24 - LT_STRNG - Compare STRING for smaller**Description**

The function FC 24 compares the contents of two variables in the format STRING to determine if one is smaller to the other and outputs the result of the comparison as a return value. The return value has the signal state "1" if the string at parameter S1 is smaller than the string at parameter S2. The characters are compared by their ASCII code (e.g. 'A' smaller than 'a'), starting from the left. The first character to be different decides the result of the comparison. If the left part of the longer character string and the shorter character string are the same, the shorter string is smaller. The function does not report any errors.

Parameter

Parameter	Declaration	Data type	Memory area	Description
S1*	INPUT	STRING	D, L	Input variable in format STRING
S2*	INPUT	STRING	D, L	Input variable in format STRING
RET_VAL	OUTPUT	BOOL	I, Q, M, D, L	Comparison result

*) You can assign only a symbolically defined variable for the parameter.

15.2.26 FC 25 - MAX - Select maximum**Description**

The function FC 25 selects the largest of three numerical variable values.

- Variables of the data types INT, DINT, and REAL are permitted as input values.
- All variables with parameters assigned must be of the same data type.
- The variable type is recognized by the ANY pointer.
- The output value remains unchanged and the BR bit is set to "0" if:
 - a variable with parameters assigned has an invalid data type.
 - all variables with parameters assigned do not have the same data type.
 - a REAL variable does not represent a valid floating-point number.

Parameter

Parameter	Declaration	Data type	Memory area	Description
IN1	INPUT	ANY	I, Q, M, D, L	1. Input value
IN2	INPUT	ANY	I, Q, M, D, L	2. Input value
IN3	INPUT	ANY	I, Q, M, D, L	3. Input value
RET_VAL	OUTPUT	ANY	I, Q, M, D, L	Largest of the input values



The admitted data types INT, DINT and REAL must be entered in the ANY pointer. Such parameters as "MD20" are also admitted, but you must define the corresponding data type of "MD20" in "Symbol".

Example in STL:

```
CALL FC 25
IN1 := P#M 10.0 DINT 1
IN2 := MD20
IN3 := P#DB1.DBX 0.0 DINT 1
RET_VAL := P#M 40.0 DINT 1
= M 0.0
```

15.2.27 FC 26 - MID - Middle part of a STRING variable**Description**

The function FC 26 provides the middle part of a string (L characters from the character P inclusive).

- If the sum of L and $(P-1)$ exceeds the current length of the STRING variables, a string is returned from the character P to the end of the input value.
- In all other cases (P is outside the current length, P and/or L are equal to zero or negative), a blank string is returned and the BR bit is set to "0".

Parameter

Parameter	Declaration	Data type	Memory area	Description
IN*	INPUT	STRING	D, L	Input variable in format STRING
L	INPUT	INT	I, Q, M, D, L Constant	Length of the middle character string
P	INPUT	INT	I, Q, M, D, L Constant	Position of first character
RET_VAL*	OUTPUT	STRING	D, L	Output variable in format STRING

*) You can assign only a symbolically defined variable for the parameter.

15.2.28 FC 27 - MIN - Select minimum**Description**

The function FC 27 selects the smallest of three numerical variable values.

- Variables of the data types INT, DINT, and REAL are permitted as input values.
- All variables with parameters assigned must be of the same data type.
- The variable type is recognized by the ANY pointer.
- The output value remains unchanged and the BR bit is set to "0" if:
 - a variable with parameters assigned has an invalid data type.
 - all variables with parameters assigned do not have the same data type.
 - a REAL variable does not represent a valid floating-point number.

Parameter

IEC > FC 29 - NE_STRNG - Compare STRING for unequal

Parameter	Declaration	Data type	Memory area	Description
IN1	INPUT	ANY	I, Q, M, D, L	1. Input value
IN2	INPUT	ANY	I, Q, M, D, L	2. Input value
IN3	INPUT	ANY	I, Q, M, D, L	3. Input value
RET_VAL	OUTPUT	ANY	I, Q, M, D, L	Smallest of the input values



The admitted data types INT, DINT and REAL must be entered in the ANY pointer. Such parameters as "MD20" are also admitted, but you must define the corresponding data type of "MD20" in "Symbol".

Example in STL:

```
CALL FC 27
IN1 := P#M 10.0 DINT 1
IN2 := MD20
IN3 := P#DB1.DBX 0.0 DINT 1
RET_VAL := P#M 40.0 DINT 1
= M 0.0
```

15.2.29 FC 28 - NE_DT - Compare DT for unequal**Description**

The function FC 28 compares the contents of two variables in the format DATE_AND_TIME to determine if they are unequal and outputs the result of the comparison as a return value. The return value has the signal state "1" if the time at parameter DT1 is unequal the time at parameter DT2. The function does not report any errors.

Parameter

Parameter	Declaration	Data type	Memory area	Description
DT1*	INPUT	DATE_AND_TIME	D, L	Input variable in format TD
DT2*	INPUT	DATE_AND_TIME	D, L	Input variable in format TD
RET_VAL	OUTPUT	BOOL	I, Q, M, D, L	Comparison result

*) You can assign only a symbolically defined variable for the parameter.

15.2.30 FC 29 - NE_STRNG - Compare STRING for unequal**Description**

The function FC 29 compares the contents of two variables in the format STRING to determine if they are unequal and outputs the result of the comparison as a return value. The return value has the signal state "1" if the string at parameter S1 is unequal to the string at parameter S2. The function does not report any errors.

Parameter

Parameter	Declaration	Data type	Memory area	Description
S1*	INPUT	STRING	D, L	Input variable in format STRING
S2*	INPUT	STRING	D, L	Input variable in format STRING
RET_VAL	OUTPUT	BOOL	I, Q, M, D, L	Comparison result

*) You can assign only a symbolically defined variable for the parameter.

15.2.31 FC 30 - R_STRNG - Convert REAL to STRING**Description**

The function FC 30 converts a variable in REAL data format to a string.

- The string is shown with 14 digits:
±v.nnnnnnnE±xx
 - ±: Sign
 - v: 1 digit before the decimal point
 - n: 7 digits after the decimal point
 - x: 2 exponential digits
- If the variable given at the return parameter is too short or if no valid floating-point number is given at parameter IN, no conversion takes place and the BR bit is set to "0".

Parameter

Parameter	Declaration	Data type	Memory area	Description
IN	INPUT	REAL	I, Q, M, D, L Constant	Input value
RET_VAL*	OUTPUT	STRING	D, L	Result string

*) You can assign only a symbolically defined variable for the parameter.

15.2.32 FC 31 - REPLACE - Replace in a STRING variable**Description**

The function FC 31 replaces a number of characters *L* of the first string *IN1* starting at the character at position *P* (inclusive) with the entire second string *IN2*.

- If *L* is equal to zero and *P* is not equal to zero, the first string is returned.
- If *L* is equal to zero and *P* is equal to zero, the second string is present to the first string.
- If *L* is not equal to zero and *P* is equal to zero or one, the string is replaced from the 1. character (inclusive).
- If *P* is outside the first string, the second string is appended to the first string.
- If *L* and/or *P* is negative, a blank string is returned and the BR bit is set to "0". The BR bit is also set to "0" if the resulting string is longer than the variable given at the output parameter; in this case the result string is limited to the maximum set length.

Parameter

Parameter	Declaration	Data type	Memory area	Description
IN1*	INPUT	STRING	D, L	STRING variable to be inserted into
IN2*	INPUT	STRING	D, L	STRING variable to be inserted
L	INPUT	INT	I, Q, M, D, L Constant	Number of characters to be replaced
P	INPUT	INT	I, Q, M, D, L Constant	Position of 1. character to be replaced
RET_VAL*	OUTPUT	STRING	D, L	Result string

*) You can assign only a symbolically defined variable for the parameter.

15.2.33 FC 32 - RIGHT - Right part of a STRING variable**Description**

The function FC 32 provides the last L characters of a string.

- If L is greater than the current length of the STRING variable, the input value is returned.
- With $L = 0$ and with a blank string as the input value, a blank string is returned.
- If L is negative, a blank string is returned and the BR bit is set to "0".

Parameter

Parameter	Declaration	Data type	Memory area	Description
IN*	INPUT	STRING	D, L	Input variable in format STRING
L	INPUT	INT	I, Q, M, D, L Constant	Length of the right character string
RET_VAL*	OUTPUT	STRING	D, L	Output variable in format STRING

*) You can assign only a symbolically defined variable for the parameter.

15.2.34 FC 33 - S5TI_TIM - Convert S5TIME to TIME**Description**

The function FC 33 converts the data format S5TIME to the data format TIME. If the result of the conversion is outside the TIME range, the result is limited to the corresponding value and the binary result (BR) bit is set to "0".

Parameter

Parameter	Declaration	Data type	Memory area	Description
IN	INPUT	S5TIME	I, Q, M, D, L Constant	Input variable in format S5TIME
RET_VAL	OUTPUT	TIME	I, Q, M, D, L	Return value in format TIME

15.2.35 FC 34 - SB_DT_DT - Subtract two instants of time

Description

The function FC 34 subtracts two instants of time DTx (date and time) and provides a duration (time) as the result. The instants of time DTx must be in the range DT#1990-01-01-00:00:00.000 ... DT#2089-12-31-23:59:59.999. The function does not check the input parameters. It is valid:

- With $DT1 > DT2$ the result is positive.
- With $DT1 < DT2$ the result is negative.
- If the result of the subtraction is outside the TIME range, the result is limited to the corresponding value and the binary result (BR) bit is set to "0".

Parameter

Parameter	Declaration	Data type	Memory area	Description
DT1*	INPUT	DATE_AND_TIME	D, L	1. instant of time in format DT
DT2*	INPUT	DATE_AND_TIME	D, L	2. Instant of time in format DT
RET_VAL	OUTPUT	TIME	I, Q, M, D, L	Difference in format TIME

*) You can assign only a symbolically defined variable for the parameter.

15.2.36 FC 35 - SB_DT_TM - Subtract a duration from a time

Description

The function FC 35 subtracts a duration D (TIME) from a time T (DT) and provides a new time (DT) as the result. The time T must be between DT#1990-01-01-00:00:00.000 and DT#2089-12-31-23:59:59.999. The function does not run an input check. If the result of the subtraction is not within the valid range, the result is limited to the corresponding value and the binary result (BR) bit of the status word is set to "0".

Parameter

Parameter	Declaration	Data type	Memory area	Description
T*	INPUT	DATE_AND_TIME	D, L	Time in format DT
D	INPUT	TIME	I, Q, M, D, L, constant	Duration in format TIME
RET_VAL *	OUTPUT	DATE_AND_TIME	D, L	Difference in format DT

*) You can assign only a symbolically defined variable for the parameter.

15.2.37 FC 36 - SEL - Binary selection

Description

The function FC 36 selects one of two variable values depending on a switch G .

- Variables with all data types which correspond to the data width bit, byte, word, and double word (not data types DT and STRING) are permitted as input values at the parameters $IN0$ and $IN1$.
- $IN0$, $IN1$ and RET_VAL must be of the same data type.
- The output value remains unchanged and the BR bit is set to "0" if:
 - a variable with parameters assigned has an invalid data type.
 - all variables with parameters assigned do not have the same data type.
 - a REAL variable does not represent a valid floating-point number.

Parameter

Parameter	Declaration	Data type	Memory area	Description
G	INPUT	BOOL	I, Q, M, D, L Constant	Selection switch
IN0	INPUT	ANY	I, Q, M, D, L	1. Input value
IN1	INPUT	ANY	I, Q, M, D, L	2. Input value
RET_VAL	OUTPUT	ANY	I, Q, M, D, L	Selected input value

15.2.38 FC 37 - STRNG_DI - Convert STRING to DINT**Description**

The function FC 37 converts a string to a variable in DINT data format.

- The first character in the string may be a sign or a number, the characters which then follow must be numbers.
- If the length of the string is equal to zero or greater than 11, or if invalid characters are found in the string, no conversion takes place and the BR bit is set to "0".
- If the result of the conversion is outside the DINT range, the result is limited to the corresponding value and the BR bit is set to "0".

Parameter

Parameter	Declaration	Data type	Memory area	Description
S*	INPUT	STRING	D, L	Input string
RET_VAL	OUTPUT	DINT	I, Q, M, D, L	Result

*) You can assign only a symbolically defined variable for the parameter.

15.2.39 FC 38 - STRNG_I - Convert STRING to INT**Description**

The function FC 38 converts a string to a variable in INT data format.

- The first character in the string may be a sign or a number, the characters which then follow must be numbers.
- If the length of the string is equal to zero or greater than 6, or if invalid characters are found in the string, no conversion takes place and the BR bit is set to "0".
- If the result of the conversion is outside the INT range, the result is limited to the corresponding value and the BR bit is set to "0".

Parameter

Parameter	Declaration	Data type	Memory area	Description
S*	INPUT	STRING	D, L	Input string
RET_VAL	OUTPUT	INT	I, Q, M, D, L	Result

*) You can assign only a symbolically defined variable for the parameter.

15.2.40 FC 39 - STRNG_R - Convert STRING to REAL

Description

The function FC 39 converts a string to a variable in REAL data format.

- The string must have the following format:
±v.nnnnnnnE±xx
 - ±: Sign
 - v: 1 digit before the decimal point
 - n: 7 digits after the decimal point
 - x: 2 exponential digits
- If the length of the string is smaller than 14, or if it is not structured as shown above, no conversion takes place and the BR bit is set to "0".
- If the result of the conversion is outside the REAL range, the result is limited to the corresponding value and the BR bit is set to "0".

Parameter

Parameter	Declaration	Data type	Memory area	Description
S*	INPUT	STRING	D, L	Input string
RET_VAL	OUTPUT	REAL	I, Q, M, D, L	Result

*) You can assign only a symbolically defined variable for the parameter.

15.2.41 FC 40 - TIM_S5TI - Convert TIME to S5TIME

Description

The function FC 40 converts the data format TIME to the format S5TIME. Here is always rounded down. If the input parameter is greater than the displayable S5TIME format (TIME#02:46:30.000), S5TIME#999.3 is output as result and the binary result (BR) bit is set to "0".

Parameter

Parameter	Declaration	Data type	Memory area	Description
IN	INPUT	TIME	I, Q, M, D, L Constant	Input variable in format TIME
RET_VAL	OUTPUT	S5TIME	I, Q, M, D, L	Return value in format S5TIME

15.3 IO

15.3.1 FB 20 - GETIO - PROFIBUS/PROFINET read all Inputs

Description

With the FB 20 GETIO you consistently read out all inputs of a PROFIBUS DP slave/PROFINET IO device. In doing so, FB 20 calls the SFC 14 DPRD_DAT. If there was no error during the data transmission, the data that have been read are entered in the target area indicated by *INPUTS*. The target area must have the same length that you configured for the selected component. In the case of a PROFIBUS DP slave with a modular structure or with several DP IDs, you can only access the data for one component/DP ID with an FB 20 call each time at the configured start address.

IO > FB 22 - GETIO_PART - PROFIBUS/PROFINET read a part of the Inputs

Parameter	Declaration	Data Type	Memory Area	Description
ID	INPUT	DWORD	I, Q, M, D, L constant	<ul style="list-style-type: none"> ■ Low word: logical address of the DP slave/PROFINET IO component (module or submodule) ■ High word: irrelevant
STATUS	OUTPUT	DWORD	I, Q, M, D, L	Contains error information for SFC 14 DPRD_DAT in the form DW#16#40xxxx00
LEN	OUTPUT	INT	I, Q, M, D, L	Amount of data read in bytes
INPUTS	IN_OUT	ANY	I, Q, M, D	Target area for the read data. It must have the same length as the area that you configured for the selected DP slave/PROFINET IO component. Only the data type BYTE is permitted.

Error Information

Please refer to SFC 14 - DPRD_DAT - Read consistent data. ↪ 659

15.3.2 FB 21 - SETIO - PROFIBUS/PROFINET write all Outputs**Description**

With the FB 21 SETIO you consistently transfer the data from the source area indicated by *OUTPUTS* to the addressed PROFIBUS DP slave/PROFINET IO device, and, if necessary, to the process image (in the case where you have configured the affected address area for the DP standard slave as a consistency area in a process image). In doing so, FB 21 calls the SFC 15 DPWR_DAT. The source area must have the same length that you configured with for the selected component. In the case of a DP standard slave with a modular structure or with several DP IDs, you can only access the data for one component/DP ID with an FB 20 call each time at the configured start address.

Parameter	Declaration	Data Type	Memory Area	Description
ID	INPUT	DWORD	I, Q, M, D, L, constant	<ul style="list-style-type: none"> ■ Low word: logical address of the DP slave/PROFINET IO component (module or submodule) ■ High word: irrelevant
LEN	INPUT	INT	I, Q, M, D, L	Irrelevant
STATUS	OUTPUT	DWORD	I, Q, M, D, L	Contains error information for SFC 15 DPRD_DAT in the form DW#16#40xxxx00
OUTPUTS	IN_OUT	ANY	I, Q, M, D	Source area for the read data to be read. It must have the same length as the area that you configured for the selected DP slave/PROFINET IO component. Only the data type BYTE is permitted.

Error Information

Please refer to SFC 15 - DPWR_DAT - Write consistent data. ↪ 660

15.3.3 FB 22 - GETIO_PART - PROFIBUS/PROFINET read a part of the Inputs**Description**

With the FB 22 GETIO_PART you consistently read a part of the process image area belonging to a PROFIBUS DP slave/PROFINET IO device. In doing so, FB 22 calls the SFC 81 UBLKMOV.



You must assign a process image partition for inputs to the OB in which FB 22 GETIO_PART is called. Furthermore, before calling FB 22 you must add the associated PROFIBUS DP slave or the associated PROFINET IO device to this process image partition for inputs. If your CPU does not recognize any process image partitions or you want to call FB 22 in OB 1, you must add the associated PROFIBUS DP slave or the associated PROFINET IO device to this process image partition for inputs before calling FB 22. You use the OFFSET and LEN parameters to specify the portion of the process image area to be read for the components addressed by means of their ID. If there was no error during the data transmission, ERROR receives the value FALSE, and the data that have been read are entered in the target area indicated by INPUTS. If there was an error during the data transmission, ERROR receives the value TRUE, and STATUS receives the SFC 81 error information UBLKMOV. If the target area (INPUTS parameter) is smaller than LEN, then as many bytes as INPUTS can accept are transferred. ERROR receives the value FALSE. If the target area is greater than LEN, then the first LEN bytes in the target area are written. ERROR receives the value FALSE.



The FB 22 GETIO_PART does not check the process image for inputs for delimiters between data belonging to different PROFIBUS DP or PROFINET IO components. Because of this, you yourself must make sure that the process image area specified by means of OFFSET and LEN belongs to one component. Reading of data for more than one component cannot be guaranteed for future systems and compromises the transferability to systems from other manufacturers.

Parameter	Declaration	Data Type	Memory Area	Description
ID	INPUT	DWORD	I, Q, M, D, L constant	<ul style="list-style-type: none"> ■ Low word: logical address of the DP slave/ PROFINET IO component (module or submodule) ■ High word: irrelevant
OFFSET	INPUT	INT	I, Q, M, D, L constant	Number of the first byte to be read in the process image for the component (smallest possible value: 0)
LEN	INPUT	INT	I, Q, M, D, L constant	Amount of bytes to be read
STATUS	OUTPUT	DWORD	I, Q, M, D, L	Contains error information for SFC 81 UBLKMOV in the form DW#16#40xxxx00 if ERROR = TRUE

IO > FB 23 - SETIO_PART - PROFIBUS/PROFINET write a part of the Outputs

Parameter	Declaration	Data Type	Memory Area	Description
ERROR	OUTPUT	BOOL	I, Q, M, D, L	Error display: <i>ERROR</i> = TRUE if an error occurs when calling SFC 81 UBLKMOV.
INPUTS	IN_OUT	ANY	I, Q, M, D	Target area for read data: <ul style="list-style-type: none"> ■ If the target area is smaller than <i>LEN</i>, then as many bytes as <i>INPUTS</i> can accept are transferred. <i>ERROR</i> receives the value FALSE. ■ If the target area is greater than <i>LEN</i>, then the first <i>LEN</i> bytes of the target area are written. <i>ERROR</i> receives the value FALSE.

Error Information

Please refer to SFC 81 - UBLKMOV - Copy data area without gaps. ↪ 720

15.3.4 FB 23 - SETIO_PART - PROFIBUS/PROFINET write a part of the Outputs**Description**

With the FB 23 SETIO_PART you transfer data from the source area indicated by *OUTPUTS* into a part of the process image area belonging to a PROFIBUS DP slave/PROFINET IO device. In doing so, FB 23 calls the SFC 81 UBLKMOV.



You must assign a process image partition for outputs to the OB in which FB 23 SETIO_PART is called. Furthermore, before calling FB 23 you must add the associated PROFIBUS DP slave or the associated PROFINET IO device to this process image partition for outputs. If your CPU does not recognize any process image partitions or you want to call FB 23 in OB 1, you must add the associated PROFIBUS DP slave or the associated PROFINET IO device to this process image partition for outputs before calling FB 23. You use the OFFSET and LEN parameters to specify the portion of the process image area to be written for the components addressed by means of their ID. If there was no error during the data transmission, ERROR receives the value FALSE. If there was an error during the data transmission, ERROR receives the value TRUE, and STATUS receives the SFC 81 error information UBLKMOV. If the source area (OUTPUTS parameter) is smaller than LEN, then as many bytes as OUTPUTS contains are transferred. ERROR receives the value FALSE. If the source area is greater than LEN, then the first LEN bytes are transferred from OUTPUTS. ERROR receives the value FALSE.



The FB 23 SETIO_PART does not check the process image for inputs for delimiters between data that belong to different PROFIBUS DP or PROFINET IO components. Because of this, you yourself must make sure that the process image area specified by means of OFFSET and LEN belongs to one component. Writing of data for more than one component cannot be guaranteed for future systems and compromises the transferability to systems from other manufacturers.

Parameter	Declaration	Data Type	Memory Area	Description
ID	INPUT	DWORD	I, Q, M, D, L, constant	<ul style="list-style-type: none"> Low word: logical address of the DP slave/PROFINET IO component (module or submodule) High word: irrelevant
OFFSET	INPUT	INT	I, Q, M, D, L, constant	Number of the first byte to be written in the process image for the component (smallest possible value: 0)
LEN	INPUT	INT	I, Q, M, D, L, constant	Amount of bytes to be written
STATUS	OUTPUT	DWORD	I, Q, M, D	Contains error information for SFC 81 UBLKMOV in the form DW#16#40xxxx00 if <i>ERROR</i> = TRUE
ERROR	OUTPUT	BOOL	I, Q, M, D	Error display: <i>ERROR</i> = TRUE if an error occurs when calling SFC 81 UBLKMOV.
OUTPUTS	IN_OUT	ANY	I, Q, M, D	Source area for the data to be written: <ul style="list-style-type: none"> If the source area is smaller than <i>LEN</i>, then as many bytes as <i>OUTPUTS</i> contains are transferred. <i>ERROR</i> receives the value FALSE. If the source area is greater than <i>LEN</i>, then the first <i>LEN</i> bytes are transferred from <i>OUTPUTS</i>. <i>ERROR</i> receives the value FALSE.

Error Information

Please refer to SFC 81 - UBLKMOV - Copy data area without gaps. ↪ 720

15.4 S5 Converting**15.4.1 FC 112 - Sine(x) - Sine****Description**

The function FC 112 expects the input value in ACCU 1 as a floating point number.

1. ➤ The input value must be within the range between zero
(REAL = +0.0000000e+00) ... $2 \times \pi$ (REAL = +0.6283185e+01)
2. ➤ The function also stores the result in ACCU 1 as a floating point number.
3. ➤ The input value DWORD = DW#16#0000 0000 is treated the same way as the floating point value zero (REAL = +0.0000000e+00 in accordance with DWORD = DW#16#8000 0000).
 - ⇒ If the calculation is carried out correctly, the RLO *ENO* is FALSE after the function has been called up.

Parameters

Parameter	Declaration	Data Type	Memory Area	Description
EN	INPUT	BOOL	I, Q, M, D, L	<ul style="list-style-type: none"> ■ Enable <ul style="list-style-type: none"> – TRUE: activates the function – FALSE: deactivates the function
ENO	OUTPUT	BOOL	I, Q, M, D, L	<ul style="list-style-type: none"> ■ Status <ul style="list-style-type: none"> – TRUE: function executed with error

Error information

In the event of an error, the function sets the RLO to signal state *ENO* to TRUE (if the input value is out of range from 0 to $2 \times \pi$). In this case, the contents of ACCU 1 remain unchanged. The assignment of the remaining registers and the auxiliary flags are not changed.



This function is only used to convert the FB 101 of an existing S5 program to a function of an S7 program programmable controller.

15.4.2 FC 113 - Cosine(x) - Cosine

Description

The function FC 113 expects the input value in ACCU 1 as a floating point number.

1. The input value must be within the range between zero (REAL = +0.0000000e+00) ... $2 \times \pi$ (REAL = +0.6283185e+01)
2. The function also stores the result in ACCU 1 as a floating point number.
3. The input value DWORD = DW#16#0000 0000 is treated the same way as the floating point value zero (REAL = +0.0000000e+00 in accordance with DWORD = DW#16#8000 0000).
 - ⇒ If the calculation is carried out correctly, the RLO *ENO* is FALSE after the function has been called up.

Parameters

Parameter	Declaration	Data Type	Memory Area	Description
EN	INPUT	BOOL	I, Q, M, D, L	<ul style="list-style-type: none"> ■ Enable <ul style="list-style-type: none"> – TRUE: activates the function – FALSE: deactivates the function
ENO	OUTPUT	BOOL	I, Q, M, D, L	<ul style="list-style-type: none"> ■ Status <ul style="list-style-type: none"> – TRUE: function executed with error

Error information

In the event of an error, if the input value is out of range from 0 ... $2 \times \pi$, the function sets the RLO to signal state *ENO* to TRUE. In this case, the contents of ACCU 1 remain unchanged. The assignment of the remaining registers and the auxiliary flags are not changed.



This function is only used to convert the FB 102 of an existing S5 program to a function of an S7 program programmable controller.

15.4.3 FC 114 - Tangent(x) - Tangent

Description

The function FC 114 expects the input value in ACCU 1 as a floating point number.

1. The input value must be within the range between zero
(REAL = +0.0000000e+00) ... $2 \times \pi$ (REAL = +0.6283185e+01)
2. The function also stores the result in ACCU 1 as a floating point number.
3. The input value DWORD = DW#16#0000 0000 is treated the same way as the floating point value zero (REAL = +0.0000000e+00 in accordance with DWORD = DW#16#8000 0000).
 - ⇒ If the calculation is carried out correctly, the RLO *ENO* is FALSE after the function has been called up.

Parameters

Parameter	Declaration	Data Type	Memory Area	Description
EN	INPUT	BOOL	I, Q, M, D, L	<ul style="list-style-type: none"> ■ Enable <ul style="list-style-type: none"> – TRUE: activates the function – FALSE: deactivates the function
ENO	OUTPUT	BOOL	I, Q, M, D, L	<ul style="list-style-type: none"> ■ Status <ul style="list-style-type: none"> – TRUE: function executed with error

Error information

In the event of an error, the function sets the RLO to signal state *ENO* to TRUE. In this case, the contents of accumulator 1 remain unchanged. One of the following errors has occurred:

- The input value is out of range from 0 ... $2 \times \pi$.
- A number range overflow occurred during calculation of the function.
- The input value amounts to $\pi/2$ or $3 \times \pi/2$. In this case, the function value is infinite.

The assignment of the remaining registers and the auxiliary flags are not changed.



This function is only used to convert the FB 103 of an existing S5 program to a function of an S7 program programmable controller.

15.4.4 FC 115 - Cotangent(x) - Cotangent

Description

The function FC 115 expects the input value in ACCU 1 as a floating point number.

1. The input value must be within the range between zero
(REAL = +0.0000000e+00) ... $2 \times \pi$ (REAL = +0.6283185e+01)

2. ➤ The function also stores the result in ACCU 1 as a floating point number.
3. ➤ The input value DWORD = DW#16#0000 0000 is treated the same way as the floating point value zero (REAL = +0.0000000e+00 in accordance with DWORD = DW#16#8000 0000).
 - ⇒ If the calculation is carried out correctly, the RLO *ENO* is FALSE after the function has been called up.

Parameters

Parameter	Declaration	Data Type	Memory Area	Description
EN	INPUT	BOOL	I, Q, M, D, L	<ul style="list-style-type: none"> ■ Enable <ul style="list-style-type: none"> – TRUE: activates the function – FALSE: deactivates the function
ENO	OUTPUT	BOOL	I, Q, M, D, L	<ul style="list-style-type: none"> ■ Status <ul style="list-style-type: none"> – TRUE: function executed with error

Error information

In the event of an error, the function sets the RLO to signal state *ENO* to TRUE. In this case, the contents of accumulator 1 remain unchanged. One of the following errors has occurred:

- The input value is out of range from REAL = +0.2938734e-34 and REAL = +0.6283184e+01.
- A number range overflow occurred during calculation of the function.
- The input value amounts to zero or π or $2 \times \pi$. In this case, the function value is infinite.

The assignment of the remaining registers and the auxiliary flags are not changed.



This function is only used to convert the FB 103 of an existing S5 program to a function of an S7 program programmable controller.

15.4.5 FC 116 - Arc Sine(x) - Arcussine

Description

The function FC 116 expects the input value in ACCU 1 as a floating point number.

1. ➤ The input value must be within the range between
 - 1 (REAL = -0.1000000e+01) ... +1 (REAL = +0.1000000e+01)
2. ➤ The function also stores the result in ACCU 1 as a floating point number.
3. ➤ The input value DWORD = DW#16#0000 0000 is treated the same way as the floating point value zero (REAL = +0.0000000e+00 in accordance with DWORD = DW#16#8000 0000).
 - ⇒ If the calculation is carried out correctly, the RLO *ENO* is FALSE after the function has been called up.

Parameters

Parameter	Declaration	Data Type	Memory Area	Description
EN	INPUT	BOOL	I, Q, M, D, L	<ul style="list-style-type: none"> ■ Enable <ul style="list-style-type: none"> – TRUE: activates the function – FALSE: deactivates the function
ENO	OUTPUT	BOOL	I, Q, M, D, L	<ul style="list-style-type: none"> ■ Status <ul style="list-style-type: none"> – TRUE: function executed with error

Error information

In the event of an error, if the input value is out of range of -1 ... +1, the function sets the RLO signal state *ENO* to TRUE. The assignment of the remaining registers and the auxiliary flags are not changed.



This function is only used to convert the FB 105 of an existing S5 program to a function of an S7 program programmable controller.

15.4.6 FC 117 - Arc Cosine(x) - Arcuscosine

Description

The function FC 117 expects the input value in ACCU 1 as a floating point number.

1. The input value must be within the range between
-1 (REAL = -0.1000000e+01) ... +1 (REAL = +0.1000000e+01)
2. The function also stores the result in ACCU 1 as a floating point number.
3. The input value DWORD = DW#16#0000 0000 is treated the same way as the floating point value zero (REAL = +0.0000000e+00 in accordance with DWORD = DW#16#8000 0000).
⇒ If the calculation is carried out correctly, the RLO *ENO* is FALSE after the function has been called up.

Parameters

Parameter	Declaration	Data Type	Memory Area	Description
EN	INPUT	BOOL	I, Q, M, D, L	<ul style="list-style-type: none"> ■ Enable <ul style="list-style-type: none"> – TRUE: activates the function – FALSE: deactivates the function
ENO	OUTPUT	BOOL	I, Q, M, D, L	<ul style="list-style-type: none"> ■ Status <ul style="list-style-type: none"> – TRUE: function executed with error

Error information

In the event of an error, if the input value is out of range of -1 ... +1, the function sets the RLO signal state *ENO* to TRUE. The assignment of the remaining registers and the auxiliary flags are not changed.







This function is only used to convert the FB 106 of an existing S5 program to a function of an S7 program programmable controller.

15.4.7 FC 118 - Arc Tangent(x) - Arcustangent

Description

The function FC 118 expects the input value in ACCU 1 as a floating point number.

1.  The input value must be within the range between
-1 (REAL = -0.1000000e+01) ... +1 (REAL = +0.1000000e+01)
2.  The function also stores the result in ACCU 1 as a floating point number.
3.  The input value DWORD = DW#16#0000 0000 is treated the same way as the floating point value zero (REAL = +0.0000000e+00 in accordance with DWORD = DW#16#8000 0000).
4.  If the input value is greater than REAL = +0.1209486e+07, the result $+\pi/2$ is issued.
If the input value is less than REAL = -0.5773456e+07, the result $\pi/2$ is issued.
⇒ The RLO *ENO* is set to signal state FALSE.

Parameters

Parameter	Declaration	Data Type	Memory Area	Description
EN	INPUT	BOOL	I, Q, M, D, L	<ul style="list-style-type: none"> ■ Enable <ul style="list-style-type: none"> - TRUE: activates the function - FALSE: deactivates the function
ENO	OUTPUT	BOOL	I, Q, M, D, L	<ul style="list-style-type: none"> ■ Status <ul style="list-style-type: none"> - TRUE: function executed with error

Error information

In the event of an error, if the input value is out of range of -1 ... +1, the function sets the RLO signal state *ENO* to TRUE. The assignment of the remaining registers and the auxiliary flags are not changed.







This function is only used to convert the FB107 of an existing S5 program to a function of an S7 program programmable controller.

15.4.8 FC 119 - Arc Cotangent(x) - Arcuscotangent

Description

The function FC 119 expects the input value in ACCU 1 as a floating point number.

1.  The input value must be within the range between
-1 (REAL = -0.1000000e+01) ... +1 (REAL = +0.1000000e+01)
2.  The function also stores the result in ACCU 1 as a floating point number.
3.  The input value DWORD = DW#16#0000 0000 is treated the same way as the floating point value zero (REAL = +0.0000000e+00 in accordance with DWORD = DW#16#8000 0000).
4.  If the input value is greater than REAL = +1.209486e+07, the result $+\pi/2$ is issued.
If the input value is less than REAL = -0.5773456e+07, the result $\pi/2$ is issued.
⇒ The RLO *ENO* is set to signal state FALSE.

Parameters

Parameter	Declaration	Data Type	Memory Area	Description
EN	INPUT	BOOL	I, Q, M, D, L	<ul style="list-style-type: none"> ■ Enable <ul style="list-style-type: none"> – TRUE: activates the function – FALSE: deactivates the function
ENO	OUTPUT	BOOL	I, Q, M, D, L	<ul style="list-style-type: none"> ■ Status <ul style="list-style-type: none"> – TRUE: function executed with error

Error information

In the event of an error, if the input value is not in the range of -1 ... +1, the function sets the RLO signal state *ENO* to TRUE. The assignment of the remaining registers and the auxiliary flags are not changed.



This function is only used to convert the FB 108 of an existing S5 program to a function of an S7 program programmable controller.

15.4.9 FC 120 - Naperian Logarithm In(x) - Naperian Logarithm**Description**

The function FC 120 expects the input value in accumulator 1 as a floating point number.

1. ➤ The input value must be within the range between -1 (REAL = -0.1000000e+01) and +1 (REAL = +0.1000000e+01).
2. ➤ The function also stores the result in accumulator 1 as a floating point number.
3. ➤ If the calculation is carried out correctly, the RLO is FALSE after the function has been called up.

Parameters

Parameter	Declaration	Data Type	Memory Area	Description
EN	INPUT	BOOL	I, Q, M, D, L	<ul style="list-style-type: none"> ■ Enable <ul style="list-style-type: none"> – TRUE: activates the function – FALSE: deactivates the function
ENO	OUTPUT	BOOL	I, Q, M, D, L	<ul style="list-style-type: none"> ■ Status <ul style="list-style-type: none"> – TRUE: function executed with error

Error information

In the event of an error, the function sets the *ENO* to signal state TRUE (if the input value is less than or equal to zero). In this case, the contents of accumulator 1 remain unchanged. The assignment of the remaining registers and that of the auxiliary flags are not changed.



This function is only used to convert the FB 109 of an existing S5 program to a function of an S7 program programmable controller.

15.4.10 FC 121 - Decimal Logarithm lg(x) - Decimal Logarithm

Description

The function FC 121 expects the input value in accumulator 1 as a bit floating point number.

1. ➤ The input value must be within the range between -1 (REAL = -0.1000000e+01) and +1 (REAL = +0.1000000e+01).
2. ➤ The function also stores the result in accumulator 1 as a floating point number.
3. ➤ If the calculation is carried out correctly, the RLO is FALSE after the function has been called up.

Parameters

Parameter	Declaration	Data Type	Memory Area	Description
EN	INPUT	BOOL	I, Q, M, D, L	<ul style="list-style-type: none"> ■ Enable <ul style="list-style-type: none"> – TRUE: activates the function – FALSE: deactivates the function
ENO	OUTPUT	BOOL	I, Q, M, D, L	<ul style="list-style-type: none"> ■ Status <ul style="list-style-type: none"> – TRUE: function executed with error

Error information

In the event of an error, the function sets the *ENO* to signal state TRUE (if the input value is less than or equal to zero). In this case, the contents of accumulator 1 remain unchanged. The assignment of the remaining registers and that of the auxiliary flags are not changed.



This function is only used to convert the FB 110 of an existing S5 program to a function of an S7 program programmable controller.

15.4.11 FC 122 - Gen. Logarithm to Base b - General Logarithm log (x) to base b

Description

The function FC 122 expects both the input value for the base (b) in ACCU 2 and the input value for the antilogarithm (x) in ACCU 1 as floating point numbers.

1. ➤ Both input values must be greater than zero and in addition, the base may not have the value +1.
2. ➤ If the calculation is carried out correctly, the result is stored in ACCU 1 as a floating point number, the previous contents of ACCU 3 are in ACCU 2, and the previous contents of ACCU 4 are in ACCU 3. The contents of ACCU 4 are not changed. The assignment of the remaining registers and that of the auxiliary flags are not changed.
3. ➤ In the case of a calculation without errors, the RLO *ENO* is FALSE after the function has been called up.

Parameters

Parameter	Declaration	Data Type	Memory Area	Description
EN	INPUT	BOOL	I, Q, M, D, L	<ul style="list-style-type: none"> ■ Enable <ul style="list-style-type: none"> – TRUE: activates the function – FALSE: deactivates the function
ENO	OUTPUT	BOOL	I, Q, M, D, L	<ul style="list-style-type: none"> ■ Status <ul style="list-style-type: none"> – TRUE: function executed with error

Error information

In case of an error, if one of the input values is less than or equal to zero, or if the base has the value +1, the function sets the link result *ENO* to the signal state TRUE. Then the contents of the ACCUs remain unchanged.



This function is only used to convert the FB 111 of an existing S5 program to a function of an S7 program programmable controller.

15.4.12 FC 123 - E to Power n - E high n

Description

The function FC 123 expects the input value in ACCU 1 as a floating point number.

1. ➤ The input value $DWORD = DW\#16\#0000\ 0000$ is treated the same way as the floating point value zero ($REAL = +0.0000000e+00$ in accordance with $DWORD = DW\#16\#8000\ 0000$).
2. ➤ The function also stores the result in ACCU 1 as a floating point number.
3. ➤ If the calculation is carried out correctly, the RLO *ENO* is FALSE after the function has been called up.

Parameters

Parameter	Declaration	Data Type	Memory Area	Description
EN	INPUT	BOOL	I, Q, M, D, L	<ul style="list-style-type: none"> ■ Enable <ul style="list-style-type: none"> – TRUE: activates the function – FALSE: deactivates the function
ENO	OUTPUT	BOOL	I, Q, M, D, L	<ul style="list-style-type: none"> ■ Status <ul style="list-style-type: none"> – TRUE: function executed with error

Error information

In the event of an error, if the input value is not within the range from $REAL = -0.8802962e+02$ to $REAL = +0.8802966e+02$ (than the value would be outside the number range), the function sets the RLO *ENO* to signal state TRUE. In this case, the contents of ACCU 1 remain unchanged. The assignment of the auxiliary flags is not changed.



This function is only used to convert the FB 112 of an existing S5 program to a function of an S7 program programmable controller.

15.4.13 FC 124 - 10 to Power n - 10 high n

Description

The function FC 124 expects the input value in ACCU 1 as a floating point number.

1. ➤ The input value DWORD = DW#16#0000 0000 is treated the same way as the floating point value zero (REAL = +0.0000000e+00 in accordance with DWORD = DW#16#8000 0000).
2. ➤ The function also stores the result in ACCU 1 as a floating point number.
3. ➤ If the calculation is carried out correctly, the RLO *ENO* is FALSE after the function has been called up.

Parameters

Parameter	Declaration	Data Type	Memory Area	Description
EN	INPUT	BOOL	I, Q, M, D, L	<ul style="list-style-type: none"> ■ Enable <ul style="list-style-type: none"> – TRUE: activates the function – FALSE: deactivates the function
ENO	OUTPUT	BOOL	I, Q, M, D, L	<ul style="list-style-type: none"> ■ Status <ul style="list-style-type: none"> – TRUE: function executed with error

Error information

In the event of an error, if the input value is not within the range from -0.3823079e+02 ... REAL = + 0.3823080e+02 (than the value would be outside the number range), the function sets the RLO *ENO* to signal state TRUE. In this case, the contents of ACCU 1 remain unchanged. The assignment of the auxiliary flags is not changed.



This function is only used to convert the FB 113 of an existing S5 program to a function of an S7 program programmable controller.

15.4.14 FC 125 - ACCU 2 to Power ACCU 1 - ACCU 2 high ACCU 1

Description

The function FC 125 expects both the input value for the base in ACCU 2 and the input value for the exponent in ACCU 1 as floating point numbers.

1. ➤ The input value for the base must be positive.
An input value DWORD = DW#16#0000 0000 is treated the same way as the floating point value zero (REAL = +0.0000000e+00 in accordance with DWORD = DW#16#8000 0000).
For zero high zero the result is zero.
2. ➤ The function also stores the result in ACCU 1 as a floating point number.
3. ➤ If the calculation is carried out correctly, the RLO *ENO* is FALSE after the function has been called up.

Parameters

Parameter	Declaration	Data Type	Memory Area	Description
EN	INPUT	BOOL	I, Q, M, D, L	<ul style="list-style-type: none"> ■ Enable <ul style="list-style-type: none"> – TRUE: activates the function – FALSE: deactivates the function
ENO	OUTPUT	BOOL	I, Q, M, D, L	<ul style="list-style-type: none"> ■ Status <ul style="list-style-type: none"> – TRUE: function executed with error

Error information

If the RLO *ENO* is TRUE, one of the following errors has occurred:

- the input value for the base is less than zero
- a number range overflow occurred during calculation of the function

In the event of an error, the contents of ACCU 1 and 2 remain unchanged.



This function is only used to convert the FB 114 of an existing S5 program to a function of an S7 program programmable controller.

15.5 PID Control**15.5.1 FB 41 - CONT_C - Continuous control****Description**

FB 41 CONT_C is used to control technical processes with continuous input and output variables. During parameter assignment, you can activate or deactivate subfunctions of the PID controller to adapt the controller to the process.

Parameters

Parameter	Declaration	Data Type	Description
COM_RST	INPUT	BOOL	<p>COMPLETE RESTART</p> <ul style="list-style-type: none"> ■ The block has a complete restart routine that is processed when the input <i>COM_RST</i> is set. ■ Default: FALSE
MAN_ON	INPUT	BOOL	<p>MANUAL VALUE ON</p> <ul style="list-style-type: none"> ■ If the input <i>MAN_ON</i> is set, the control loop is interrupted. A manual value is set as the manipulated value. ■ Default: TRUE
PVPER_ON	INPUT	BOOL	<p>PROCESS VARIABLE PERIPHERY ON</p> <ul style="list-style-type: none"> ■ If the process variable is read from the I/Os, the input <i>PV_PER</i> must be connected to the I/Os and the input <i>PVPER_ON</i> must be set. ■ Default: FALSE
P_SEL	INPUT	BOOL	<p>PROPORTIONAL ACTION ON</p> <ul style="list-style-type: none"> ■ The PID actions can be activated or deactivated individually in the PID algorithm. The P action is on when the input <i>P_SEL</i> is set. ■ Default: TRUE

Parameter	Declaration	Data Type	Description
I_SEL	INPUT	BOOL	<p>INTEGRAL ACTION ON</p> <ul style="list-style-type: none"> The PID actions can be activated or deactivated individually in the PID algorithm. The I action is on when the input <i>I_SEL</i> is set. Default: TRUE
INT_HOLD	INPUT	BOOL	<p>INTEGRAL ACTION HOLD</p> <ul style="list-style-type: none"> The output of the integrator can be "frozen" by setting the input <i>INT_HOLD</i>. Default: FALSE
I_ITL_ON	INPUT	BOOL	<p>INITIALIZATION OF THE INTEGRAL ACTION</p> <ul style="list-style-type: none"> The output of the integrator can be connected to the input <i>I_ITL_VAL</i> by setting the input <i>I_ITL_ON</i>. Default: FALSE
D_SEL	INPUT	BOOL	<p>DERIVATIVE ACTION ON</p> <ul style="list-style-type: none"> The PID actions can be activated or deactivated individually in the PID algorithm. The D action is on when the input <i>D_SEL</i> is set. Default: FALSE
CYCLE	INPUT	TIME	<p>SAMPLE TIME</p> <ul style="list-style-type: none"> The time between the block calls must be constant. The <i>CYCLE</i> input specifies the time between block calls. Default: T#1s Range of Values: ≥ 1ms
SP_INT	INPUT	REAL	<p>INTERNAL SETPOINT</p> <ul style="list-style-type: none"> The <i>SP_INT</i> input is used to specify a setpoint. Default: 0.0 Range of Values: -100.0...100. 0 (%) or phys. value¹
PV_IN	INPUT	REAL	<p>PROCESS VARIABLE IN</p> <ul style="list-style-type: none"> An initialization value can be set at the <i>PV_IN</i> input or an external process variable in floating point format can be connected. Default: 0.0 Range of Values: -100.0...100. 0 (%) or phys. value¹
PV_PER	INPUT	WORD	<p>PROCESS VARIABLE PERIPHERY</p> <ul style="list-style-type: none"> The process variable in the I/O format is connected to the controller at the <i>PV_PER</i> input. Default: W#16#0000
MAN	INPUT	REAL	<p>MANUAL VALUE</p> <ul style="list-style-type: none"> The <i>MAN</i> input is used to set a manual value using the operator interface functions. Default: 0.0 Range of Values: -100.0...100. 0 (%) or phys. value²

Parameter	Declaration	Data Type	Description
GAIN	INPUT	REAL	<p>PROPORTIONAL GAIN</p> <ul style="list-style-type: none"> ■ The <i>GAIN</i> input specifies the controller gain. ■ Default: 2.0 ■ Range of Values: \geq CYCLE
TI	INPUT	TIME	<p>RESET TIME</p> <ul style="list-style-type: none"> ■ The <i>TI</i> input determines the time response of the integrator. ■ Default: T#20s ■ Range of Values: \geq CYCLE
TD	INPUT	TIME	<p>DERIVATIVE TIME</p> <ul style="list-style-type: none"> ■ The <i>TD</i> input determines the time response of the derivative unit. ■ Default: T#10s ■ Range of Values: \geq CYCLE
TM_LAG	INPUT	TIME	<p>TIME LAG OF THE DERIVATIVE ACTION</p> <ul style="list-style-type: none"> ■ The algorithm of the D action includes a time lag that can be assigned at the <i>TM_LAG</i> input. ■ Default: T#2s ■ Range of Values: \geq CYCLE/2
DEADB_W	INPUT	REAL	<p>DEAD BAND WIDTH</p> <ul style="list-style-type: none"> ■ A dead band is applied to the error. The <i>DEADB_W</i> input determines the size of the dead band. ■ Default: 0.0 ■ Range of Values: \geq 0.0 (%) or phys. value¹
LMN_HLM	INPUT	REAL	<p>MANIPULATED VALUE HIGH LIMIT</p> <ul style="list-style-type: none"> ■ The manipulated value is always limited by an upper and lower limit. The <i>LMN_HLM</i> input specifies the upper limit. ■ Default: 100.0 ■ Range of Values: <i>LMN_LLM</i> ... 100.0 (%) or phys. value²
LMN_LLM	INPUT	REAL	<p>MANIPULATED VALUE LOW LIMIT</p> <ul style="list-style-type: none"> ■ The manipulated value is always limited by an upper and lower limit. The <i>LMN_LLM</i> input specifies the lower limit. ■ Default: 0.0 ■ Range of Values: -100.0... <i>LMN_HLM</i> (%) or phys. value²
PV_FAC	INPUT	REAL	<p>PROCESS VARIABLE FACTOR</p> <ul style="list-style-type: none"> ■ The <i>PV_FAC</i> input is multiplied by the process variable. The input is used to adapt the process variable range. ■ Default: 1.0

Parameter	Declaration	Data Type	Description
PV_OFF	INPUT	REAL	<p>PROCESS VARIABLE OFFSET</p> <ul style="list-style-type: none"> The <i>PV_OFF</i> input is added to the process variable. The input is used to adapt the process variable range. Default: 0.0
LMN_FAC	INPUT	REAL	<p>MANIPULATED VALUE FACTOR</p> <ul style="list-style-type: none"> The <i>LMN_FAC</i> input is multiplied by the manipulated value. The input is used to adapt the manipulated value range. Default: 1.0
LMN_OFF	INPUT	REAL	<p>MANIPULATED VALUE OFFSET</p> <ul style="list-style-type: none"> The <i>LMN_OFF</i> is added to the manipulated value. The input is used to adapt the manipulated value range. Default: 0.0
I_ITLVAL	INPUT	REAL	<p>INITIALIZATION VALUE OF THE INTEGRAL ACTION</p> <ul style="list-style-type: none"> The output of the integrator can be set at input <i>I_ITL_ON</i>. The initialization value is applied to the input <i>I_ITLVAL</i>. Default: 0.0 Range of Values: -100.0...100.0 (%) or phys. value²
DISV	INPUT	REAL	<p>DISTURBANCE VARIABLE</p> <ul style="list-style-type: none"> For feed forward control, the disturbance variable is connected to input <i>DISV</i>. Default: 0.0 Range of Values: -100.0...100.0 (%) or phys. value²
LMN	OUTPUT	REAL	<p>MANIPULATED VALUE</p> <ul style="list-style-type: none"> The effective manipulated value is output in floating point format at the <i>LMN</i> output. Default: 0.0
LMN_PER	OUTPUT	WORD	<p>MANIPULATED VALUE PERIPHERY</p> <ul style="list-style-type: none"> The manipulated value in the I/O format is connected to the controller at the <i>LMN_PER</i> output. Default: W#16#0000
QLMN_HLM	OUTPUT	BOOL	<p>HIGH LIMIT OF MANIPULATED VALUE REACHED</p> <ul style="list-style-type: none"> The manipulated value is always limited to an upper and lower limit. The output <i>QLMN_HLM</i> indicates that the upper limit has been exceeded. Default: FALSE
QLMN_LLM	OUTPUT	BOOL	<p>LOW LIMIT OF MANIPULATED VALUE REACHED</p> <ul style="list-style-type: none"> The manipulated value is always limited to an upper and lower limit. The output <i>QLMN_LLM</i> indicates that the lower limit has been exceeded. Default: FALSE

Parameter	Declaration	Data Type	Description
LMN_P	OUTPUT	REAL	PROPORTIONALITY COMPONENT <ul style="list-style-type: none"> ■ The <i>LMN_P</i> output contains the proportional component of the manipulated variable. ■ Default: 0.0
LMN_I	OUTPUT	REAL	INTEGRAL COMPONENT <ul style="list-style-type: none"> ■ The <i>LMN_I</i> output contains the integral component of the manipulated value. ■ Default: 0.0
LMN_D	OUTPUT	REAL	DERIVATIVE COMPONENT <ul style="list-style-type: none"> ■ The <i>LMN_D</i> output contains the derivative component of the manipulated value.. ■ Default: 0.0
PV	OUTPUT	REAL	PROCESS VARIABLE <ul style="list-style-type: none"> ■ The effective process variable is output at the <i>PV</i> output. ■ Default: 0.0
ER	OUTPUT	REAL	ERROR SIGNAL <ul style="list-style-type: none"> ■ The effective error is output at the <i>ER</i> output. ■ Default: 0.0

1) Parameters in the setpoint and process variable branches with the same unit

2) Parameters in the manipulated value branch with the same unit

Application

You can use the controller as a PID fixed setpoint controller or in multi-loop controls as a cascade, blending or ratio controller. The functions of the controller are based on the PID control algorithm of the sampling controller with an analog signal, if necessary extended by including a pulse generator stage to generate pulse duration modulated output signals for two or three step controllers with proportional actuators.

Apart from the functions in the setpoint and process value branches, the FB implements a complete PID controller with continuous manipulated variable output and the option of influencing the manipulated value manually.

Setpoint Branch

The setpoint is entered in floating-point format at the *SP_INT* input.

Process Variable Branch

The process variable can be input in the peripheral (I/O) or floating-point format. The *CRP_IN* function converts the *PV_PER* peripheral value to a floating-point format of -100 to +100 % according to the following formula:

$$\text{Output of } CPR_IN = PV_PER * \frac{100}{27648}$$

The *PV_NORM* function normalizes the output of *CRP_IN* according to the following formula:

$$\text{Output of } PV_NORM = (\text{Output of } CPR_IN) * PV_FAC + PV_OFF$$

PV_FAC has a default of 1 and *PV_OFF* a default of 0.

Error Signal	The difference between the setpoint and process variable is the error signal. To suppress a small constant oscillation due to the manipulated variable quantization (for example in pulse duration modulation with PULSEGEN), a dead band is applied to the error signal (DEADBAND). If $DEADB_W = 0$, the dead band is switched off.
PID Algorithm	The PID algorithm operates as a position algorithm. The proportional, integral (<i>INT</i>), and derivative (<i>DIF</i>) actions are connected in parallel and can be activated or deactivated individually. This allows P, PI, PD, and PID controllers to be configured. Pure I and D controllers are also possible.
Manual Value	It is possible to switch over between a manual and an automatic mode. In the manual mode, the manipulated variable is corrected to a manually selected value. The integrator (<i>INT</i>) is set internally to $LMN - LMN_P - DISV$ and the derivative unit (<i>DIF</i>) to 0 and matched internally. This means that a switchover to the automatic mode does not cause any sudden change in the manipulated value.
Manipulated Value	<p>The manipulated value can be limited to a selected value using the <i>LMNLIMIT</i> function. Signaling bits indicate when a limit is exceeded by the input variable. The <i>LMN_NORM</i> function normalizes the output of <i>LMNLIMIT</i> according to the following formula:</p> $LMN = (\text{Output of } LMNLIMIT) * LMN_FAC + LMN_OFF$ <p><i>LMN_FAC</i> has the default 1 and <i>LMN_OFF</i> the default 0.</p> <p>The manipulated value is also available in the peripheral format. The <i>CRP_OUT</i> function converts the floating-point value <i>LMN</i> to a peripheral value according to the following formula:</p> $LMN_PER = LMN * \frac{27648}{100}$
Feedforward Control	A disturbance variable can be fed forward at the <i>DISV</i> input.
Modes	<p><i>Complete Restart/Restart</i></p> <ul style="list-style-type: none"> ■ FB 41 CONT_C has a complete restart routine that is run through when the input parameter <i>COM_RST</i> = TRUE is set. ■ During startup, the integrator is set internally to the initialization value <i>I_ITVAL</i>. When it is called in a cyclic interrupt priority class, it then continues to work starting at this value. ■ All other outputs are set to their default values.
Error Information	The block does not check for errors, so no error Information is output.

Block Diagram

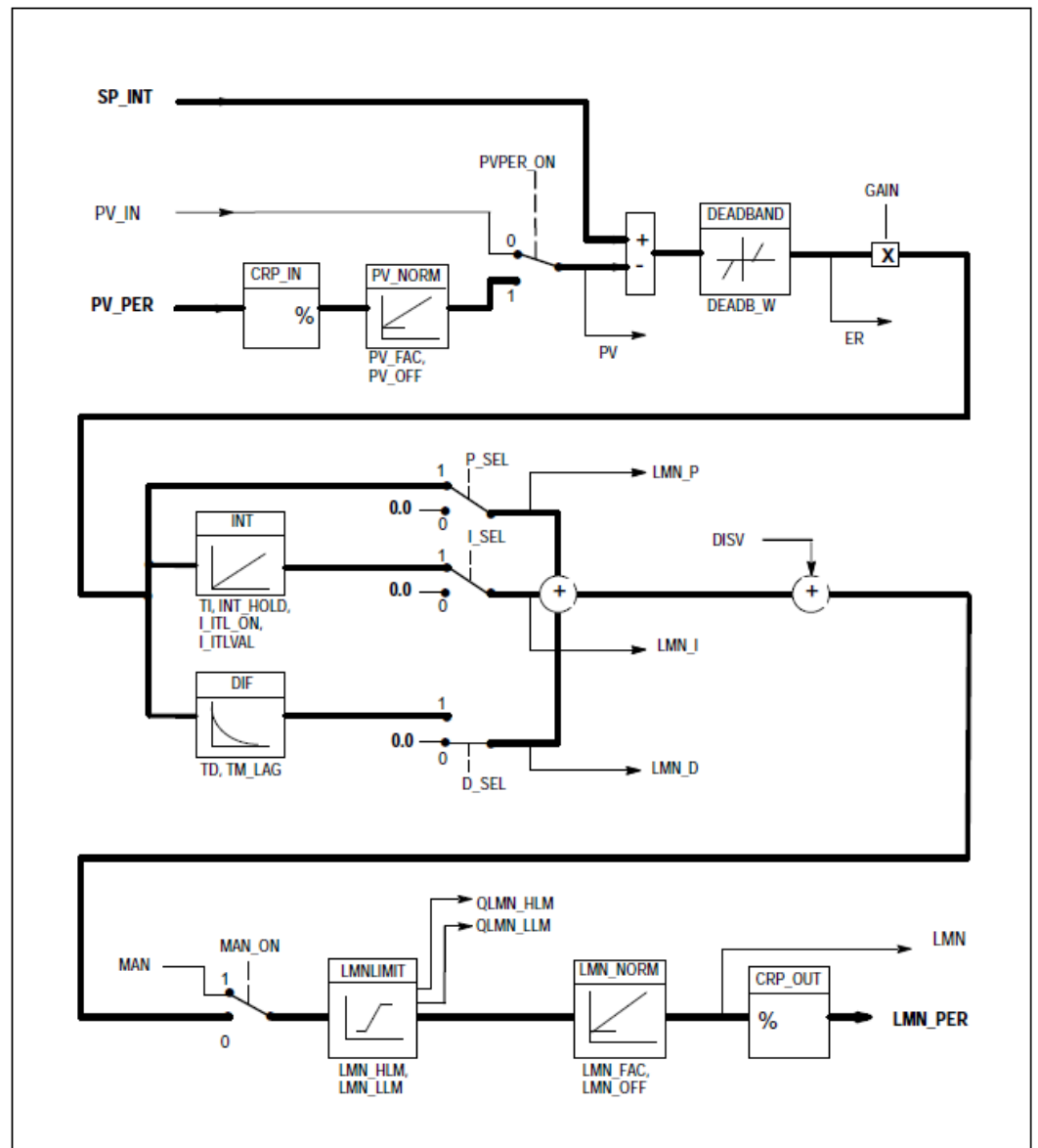

15.5.2 FB 42 - CONT_S - Step Control

Description

FB42 CONT_S is used to control technical processes with digital manipulated value output signals for integrating actuators. During parameter assignment, you can activate or deactivate subfunctions of the PI step controller to adapt the controller to the process.

Parameter

Parameter	Declaration	Data Type	Description
COM_RST	INPUT	BOOL	<p>COMPLETE RESTART</p> <ul style="list-style-type: none"> ■ The block has a complete restart routine that is processed when the input <i>COM_RST</i> is set. ■ Default: FALSE
LMNR_HS	INPUT	BOOL	<p>HIGH LIMIT SIGNAL OF REPEATED MANIPULATED VALUE</p> <ul style="list-style-type: none"> ■ The "actuator at upper limit stop" signal is connected to the <i>LMNR_HS</i> input. <ul style="list-style-type: none"> – <i>LMNR_HS</i> = TRUE means the actuator is at upper limit stop. ■ Default: FALSE
LMNR_LS	INPUT	BOOL	<p>LOW LIMIT SIGNAL OF REPEATED MANIPULATED VALUE</p> <ul style="list-style-type: none"> ■ The "actuator at lower limit stop" signal is connected to the <i>LMNR_LS</i> input. <ul style="list-style-type: none"> – <i>LMNR_LS</i> = TRUE means the actuator is at lower limit stop. ■ Default: FALSE
LMNS_ON	INPUT	BOOL	<p>MANIPULATED SIGNALS ON</p> <ul style="list-style-type: none"> ■ The actuating signal processing is switched to manual at the <i>LMNS_ON</i> input.. ■ Default: FALSE
LMNUP	INPUT	BOOL	<p>MANIPULATED SIGNALS UP</p> <ul style="list-style-type: none"> ■ With manual actuating value signals, the output signal <i>QLMNUP</i> is set at the input <i>LMNUP</i>. ■ Default: FALSE
LMNDN	INPUT	BOOL	<p>MANIPULATED SIGNALS DOWN</p> <ul style="list-style-type: none"> ■ With manual actuating value signals, the output signal <i>QLMNDN</i> is set at the input <i>LMNDN</i>. ■ Default: FALSE
PVPER_ON	INPUT	BOOL	<p>PROCESS VARIABLE PERIPHERY ON</p> <ul style="list-style-type: none"> ■ If the process variable is read in from the I/Os, the input <i>PV_PER</i> must be connected to the I/Os and the input <i>PVPER_ON</i> must be set. ■ Default: FALSE
CYCLE	INPUT	TIME	<p>SAMPLE TIME</p> <ul style="list-style-type: none"> ■ The time between the block calls must be constant. The <i>CYCLE</i> input specifies the time between block calls. ■ Default: T#1s ■ Range of Values: ≥ 1ms
SP_INT	INPUT	REAL	<p>INTERNAL SETPOINT</p> <ul style="list-style-type: none"> ■ The <i>SP_INT</i> input is used to specify a setpoint. ■ Default: 0.0 ■ Range of Values: -100.0...100.0 (%) or phys. value¹

Parameter	Declaration	Data Type	Description
PV_IN	INPUT	REAL	<p>PROCESS VARIABLE IN</p> <ul style="list-style-type: none"> An initialization value can be set at the <i>PV_IN</i> input or an external process variable in floating point format can be connected. Default: 0.0 Range of Values: -100.0...100.0 (%) or phys. value¹
PV_PER	INPUT	WORD	<p>PROCESS VARIABLE PERIPHERY</p> <ul style="list-style-type: none"> The process variable in the I/O format is connected to the controller at the <i>PV_PER</i> input. Default: W#16#0000
GAIN	INPUT	REAL	<p>PROPORTIONAL GAIN</p> <ul style="list-style-type: none"> The <i>GAIN</i> input sets the controller gain. Default: 2.0 Range of Values: \geq <i>CYCLE</i>
TI	INPUT	TIME	<p>RESET TIME</p> <ul style="list-style-type: none"> The <i>TI</i> input determines the time response of the integrator. Default: T#20s Range of Values: \geq <i>CYCLE</i>
DEADB_W	INPUT	REAL	<p>DEAD BAND WIDTH</p> <ul style="list-style-type: none"> A dead band is applied to the error. The <i>DEADB_W</i> input determines the size of the dead band. Default: 1.0 Range of Values: 0.0...100.0 (%) or phys. value¹
PV_FAC	INPUT	REAL	<p>PROCESS VARIABLE FACTOR</p> <ul style="list-style-type: none"> The <i>PV_FAC</i> input is multiplied by the process variable. The input is used to adapt the process variable range. Default: 1.0
PV_OFF	INPUT	REAL	<p>PROCESS VARIABLE OFFSET</p> <ul style="list-style-type: none"> The <i>PV_OFF</i> input is added to the process variable. The input is used to adapt the process variable range. Default: 0.0
PULSE_TM	INPUT	TIME	<p>MINIMUM PULSE TIME</p> <ul style="list-style-type: none"> A minimum pulse duration can be assigned with the parameter <i>PULSE_TM</i>. Default: T#3s Range of Values: \geq <i>CYCLE</i>
BREAK_TM	INPUT	TIME	<p>MINIMUM BREAK TIME</p> <ul style="list-style-type: none"> A minimum break duration can be assigned with the parameter <i>BREAK_TM</i>. Default: T#3s Range of Values: \geq <i>CYCLE</i>

Parameter	Declaration	Data Type	Description
MTR_TM	INPUT	TIME	MOTOR MANIPULATED VALUE <ul style="list-style-type: none"> ■ The time required by the actuator to move from limit stop to limit stop is entered at the <i>MTR_TM</i> parameter. ■ Default: T#30s ■ Range of Values: \geq <i>CYCLE</i>
DISV	INPUT	REAL	DISTURBANCE VARIABLE <ul style="list-style-type: none"> ■ For feed forward control, the disturbance variable is connected to input <i>DISV</i>. ■ Default: 0.0 ■ Range of Values: -100.0...100.0 (%) or phys. value²
QLMNUP	OUTPUT	BOOL	MANIPULATED SIGNAL UP <ul style="list-style-type: none"> ■ If the output <i>QLMNUP</i> is set, the actuating valve is opened. ■ Default: FALSE
QLMNDN	OUTPUT	BOOL	MANIPULATED SIGNAL DOWN <ul style="list-style-type: none"> ■ If the output <i>QLMNDN</i> is set, the actuating valve is opened. ■ Default: FALSE
PV	OUTPUT	REAL	PROCESS VARIABLE <ul style="list-style-type: none"> ■ The effective process variable is output at the <i>PV</i> output. ■ Default: 0.0
ER	OUTPUT	REAL	ERROR SIGNAL <ul style="list-style-type: none"> ■ The effective error is output at the <i>ER</i> output. ■ Default: 0.0

1) Parameters in the setpoint and process variable branches with the same unit

2) Parameters in the manipulated value branch with the same unit

Application

You can use the controller as a PI fixed setpoint controller or in secondary control loops in cascade, blending or ratio controllers, however not as the primary controller. The functions of the controller are based on the PI control algorithm of the sampling controller supplemented by the functions for generating the binary output signal from the analog actuating signal.

Apart from the functions in the process value branch, the FB implements a complete PI controller with a digital manipulated value output and the option of influencing the manipulated value manually. The step controller operates without a position feedback signal.

Setpoint Branch

The setpoint is entered in floating-point format at the *SP_INT* input.

Process Variable Branch

The process variable can be input in the peripheral (I/O) or floating-point format. The *CRP_IN* function converts the *PV_PER* peripheral value to a floating-point format of -100 to +100 % according to the following formula:

$$\text{Output of } CPR_IN = PV_PER * \frac{100}{27648}$$

The *PV_NORM* function normalizes the Output of *CRP_IN* following formula:

$$\text{Output of } PV_NORM = (\text{Output of } CPR_IN) * PV_FAC + PV_OFF$$

PV_FAC has a default of 1 and *PV_OFF* a default of 0.

Error Signal

The difference between the setpoint and process variable is the error signal. To suppress a small constant oscillation due to the manipulated variable quantization (for example due to a limited resolution of the manipulated value by the actuator valve), a dead band is applied to the error signal (DEADBAND). If *DEADB_W* = 0, the dead band is switched off.

PI Step Algorithm

The FB operates without a position feedback signal. The I action of the PI algorithm and the assumed position feedback signal are calculated in one integrator (INT) and compared with the remaining P action as a feedback value. The difference is applied to a three-step element (THREE_ST) and a pulse generator (PULSEOUT) that creates the pulses for the actuator. The switching frequency of the controller can be reduced by adapting the threshold on of the three-step element.

Feedforward Control

A disturbance variable can be fed forward at the *DISV* input.

Modes

Complete Restart/Restart

- FB42 CONT_S has a complete restart routine that is run through when the input parameter *COM_RST* = TRUE is set.
- All other outputs are set to their default values.

Error Information

The block does not check for errors, so no error Information is output.

Block Diagram

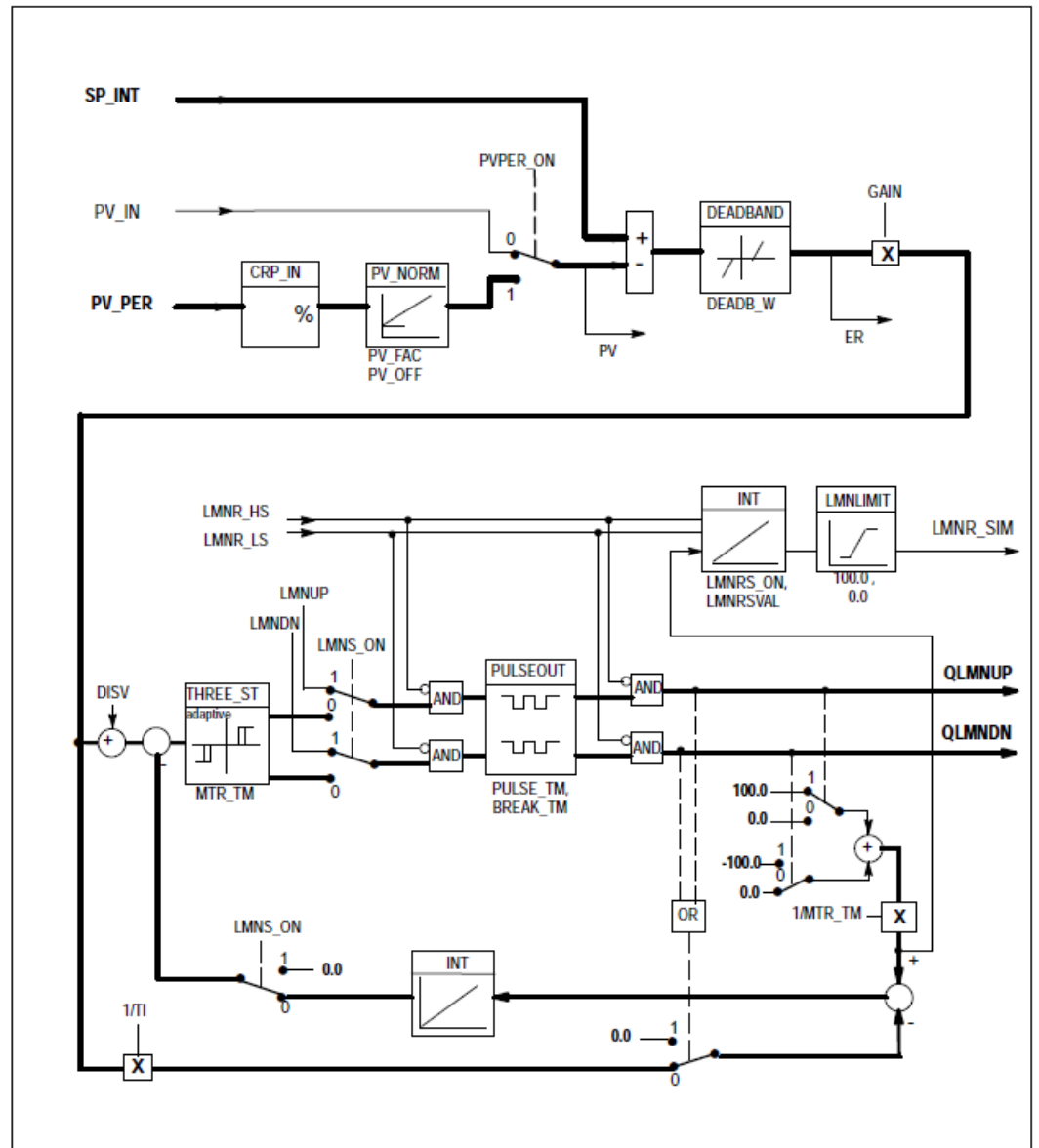

15.5.3 FB 43 - PULSGEN - Pulse generation

Description

FB 43 PULSGEN is used to structure a PID controller with pulse output for proportional actuators. Using FB43, PID two or three step controllers with pulse duration modulation can be configured. The function is normally used in conjunction with the continuous controller CONT_C.

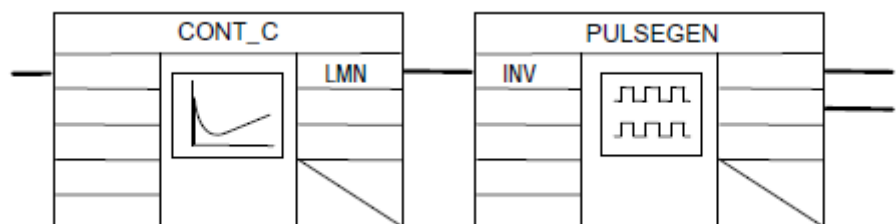

Parameters

Parameter	Declaration	Data Type	Description
INV	INPUT	REAL	<p>INPUT VARIABLE</p> <ul style="list-style-type: none"> An analog manipulated value is connected to the input parameter <i>INV</i>. Default: 0.0 Range of Values: -100.0...100.0 (%)
PER_TM	INPUT	TIME	<p>PERIOD TIME</p> <ul style="list-style-type: none"> The constant period of pulse duration modulation is input with the <i>PER_TM</i> input parameter. This corresponds to the sampling time of the controller. The ratio between the sampling time of the pulse generator and the sampling time of the controller determines the accuracy of the pulse duration modulation. Default: T#1s Range of Values: $\geq 20 \cdot CYCLE$
P_B_TM	INPUT	TIME	<p>MINIMUM PULSE/BREAK TIME</p> <ul style="list-style-type: none"> A minimum pulse or minimum break time can be assigned at the input parameters <i>P_B_TM</i>. Default: T#50ms Range of Values: $\geq CYCLE$
RATIOFAC	INPUT	REAL	<p>RATIO FACTOR</p> <ul style="list-style-type: none"> The input parameter <i>RATIOFAC</i> can be used to change the ratio of the duration of negative to positive pulses. In a thermal process, this would, for example, allow different time constants for heating and cooling to be compensated (for example, in a process with electrical heating and water cooling). Default: 1.0 Range of Values: 0.1 ...10.0
STEP3_ON	INPUT	BOOL	<p>THREE STEP CONTROL ON</p> <ul style="list-style-type: none"> The <i>STEP3_ON</i> input parameter activates this mode. In three-step control, both output signals are active. Default: TRUE
ST2BI_ON	INPUT	BOOL	<p>TWO STEP CONTROL FOR BIPOLAR MANIPULATED VALUE RANGE ON</p> <ul style="list-style-type: none"> With the input parameter <i>ST2BI_ON</i> you can select between the modes "two-step control for bipolar manipulated value" and "two-step control for monopolar manipulated value range". The parameter <i>STEP3_ON</i> = FALSE must be set. Default: FALSE
MAN_ON	INPUT	BOOL	<p>MANUAL MODE ON</p> <ul style="list-style-type: none"> By setting the input parameter <i>MAN_ON</i>, the output signals can be set manually. Default: FALSE

Parameter	Declaration	Data Type	Description
POS_P_ON	INPUT	BOOL	<p>POSITIVE MODE ON</p> <ul style="list-style-type: none"> In the manual mode with three-step control, the output signal <i>QPOS_P</i> can be set at the input parameter <i>POS_P_ON</i>. In the manual mode with two-step control, <i>QNEG_P</i> is always set inversely to <i>QPOS_P</i>. Default: FALSE
NEG_P_ON	INPUT	BOOL	<p>NEGATIVE PULSE ON</p> <ul style="list-style-type: none"> In the manual mode with three-step control, the output signal <i>QNEG_P</i> can be set at the input parameter <i>NEG_P_ON</i>. In the manual mode with two-step control, <i>QNEG_P</i> is always set inversely to <i>QPOS_P</i>. Default: FALSE
SYN_ON	INPUT	BOOL	<p>SYNCHRONISATION ON</p> <ul style="list-style-type: none"> By setting the input parameter <i>SYN_ON</i>, it is possible to synchronize automatically with the block that updates the input variable <i>INV</i>. This ensures that a changing input variable is output as quickly as possible as a pulse. Default: TRUE
COM_RST	INPUT	BOOL	<p>COMPLETE RESTART</p> <ul style="list-style-type: none"> The block has a complete restart routine that is processed when the <i>COM_RST</i> input is set. Default: FALSE
CYCLE	INPUT	TIME	<p>SAMPLE TIME</p> <ul style="list-style-type: none"> The time between block calls must be constant. The <i>CYCLE</i> input specifies the time between block calls. Default: T#10ms Range of Values: ≥ 1ms
QPOS_P	OUTPUT	BOOL	<p>OUTPUT POSITIVE PULSE</p> <ul style="list-style-type: none"> The output parameter <i>QPOS_P</i> is set when a pulse is to be output. In three-step control, this is always the positive pulse. In two-step control, <i>QNEG_P</i> is always set inversely to <i>QPOS_P</i>. Default: FALSE
QNEG_P	OUTPUT	BOOL	<p>OUTPUT NEGATIVE PULSE</p> <ul style="list-style-type: none"> The output parameter <i>QNEG_P</i> is set when a pulse is to be output. In three-step control, this is always the negative pulse. In two-step control, <i>QNEG_P</i> is always set inversely to <i>QPOS_P</i>. Default: FALSE



The values of the input parameters are not limited in the block. There is no parameter check.

Application

The PULSEGEN function transforms the input variable *INV* (= manipulated value of the PID controller) by modulating the pulse duration into a pulse train with a constant period, corresponding to the cycle time at which the input variable is updated and which must be assigned in *PER_TM*. The duration of a pulse per period is proportional to the input variable. The cycle assigned to *PER_TM* is not identical to the processing cycle of the FB PULSEGEN. The *PER_TM* cycle is made up of several processing cycles of FB PULSEGEN, whereby the number of FB PULSEGEN calls per *PER_TM* cycle is the yardstick for the accuracy of the pulse duration modulation.

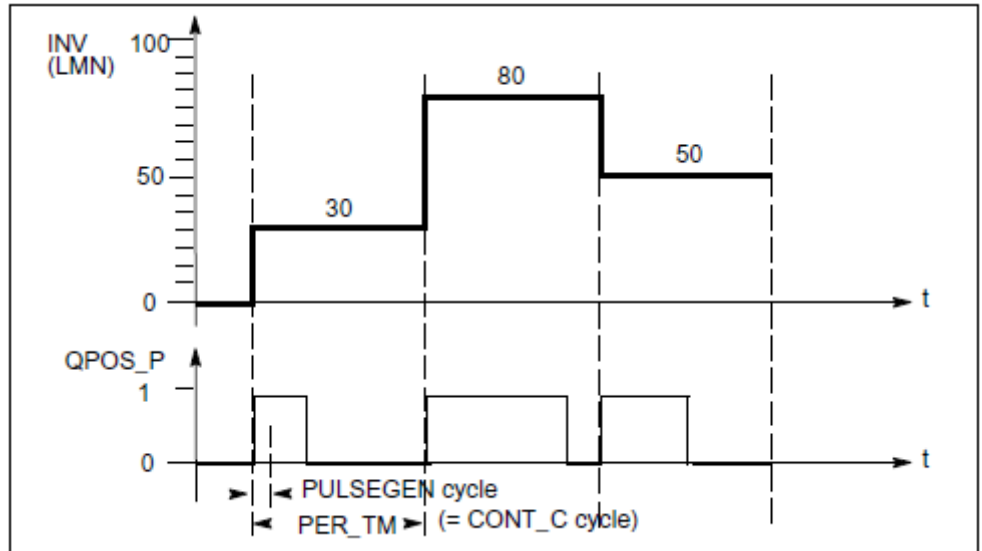

An input variable of 30% and 10 FB PULSEGEN calls per *PER_TM* means the following:

- "1" at the *QPOS* output for the first three calls of FB PULSEGEN (30% of 10 calls)
- "0" at the *QPOS* output for seven further calls of FB PULSEGEN (70% of 10 calls)

Block Diagram

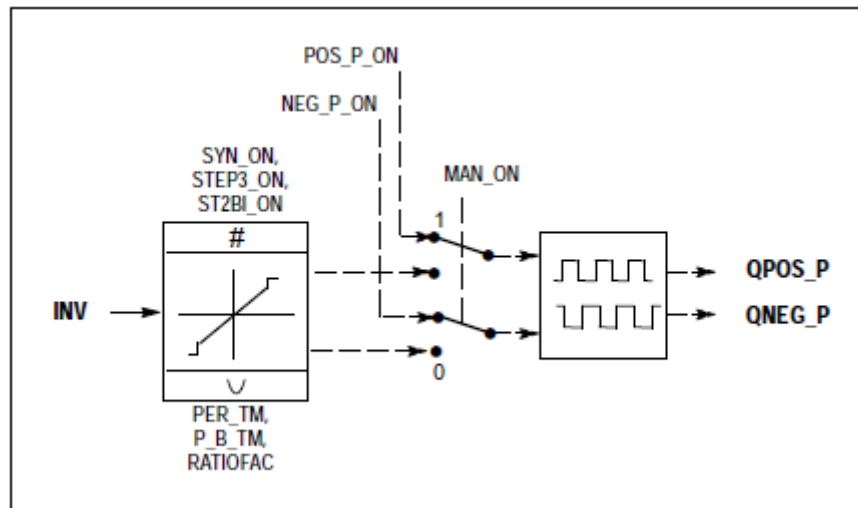

Accuracy of the Manipulated Value

With a "sampling ratio" of 1:10 (CONT_C calls to PULSEGEN calls) the accuracy of the manipulated value in this example is restricted to 10 %, in other words, set input values *INV* can only be simulated by a pulse duration at the *QPOS* output in steps of 10 %. The accuracy is increased as the number of FB PULSEGEN calls per CONT_C call is increased. If PULSEGEN is called, for example 100 times more often than CONT_C, a resolution of 1 % of the manipulated value range is achieved.



The call frequency must be programmed by the user.

Automatic Synchronization

It is possible to synchronize the pulse output with the block that updates the input variable *INV* (for example *CONT_C*). This ensures that a change in the input variable is output as quickly as possible as a pulse. The pulse generator evaluates the input value *INV* at intervals corresponding to the period *PER_TM* and converts the value into a pulse signal of corresponding length. Since, however, *INV* is usually calculated in a slower cyclic interrupt class, the pulse generator should start the conversion of the discrete value into a pulse signal as soon as possible after the updating of *INV*. To allow this, the block can synchronize the start of the period using the following procedure:

- If *INV* changes and if the block call is not in the first or last two call cycles of a period, the synchronization is performed. The pulse duration is recalculated and in the next cycle is output with a new period.

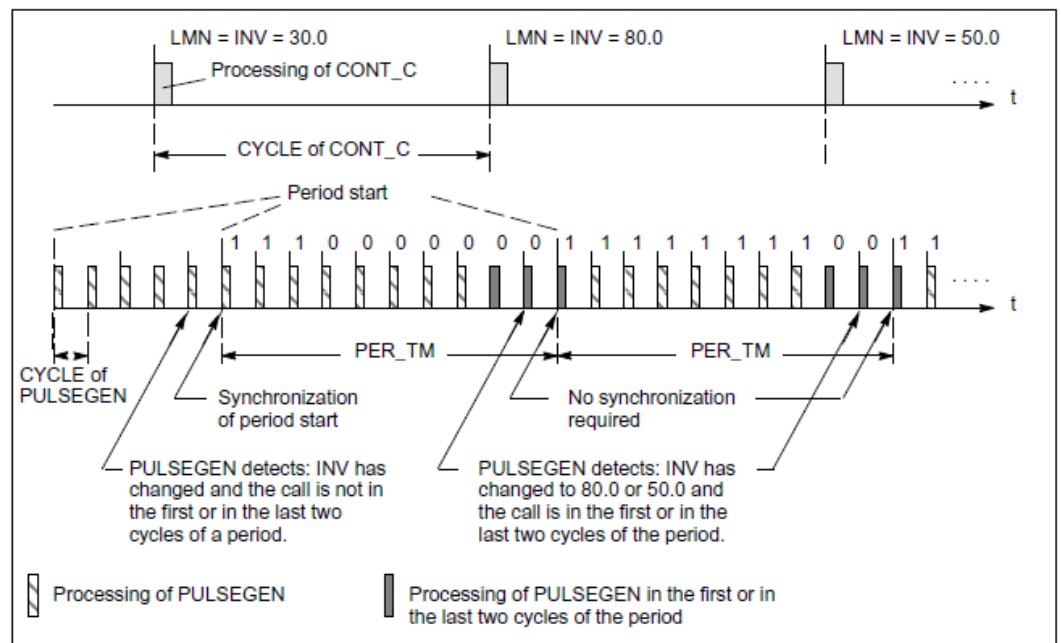

The automatic synchronization can be disabled at the *SYN_ON* input (= FALSE).



With the beginning of a new period, the old value of *INV* (in other words, of *LMN*) is simulated in the pulse signal more or less accurately following the synchronization.

Modes

Depending on the parameters assigned to the pulse generator, PID controllers with a three-step output or with a bipolar or monopolar two-step output can be configured. The following table illustrates the setting of the switch combinations for the possible modes.

Mode	Switch		
	MAN_ON	STEP3_ON	ST2BI_ON
Three-step control	FALSE	TRUE	Any
Two-step control with bipolar control range (-100 % to +100 %)	FALSE	FALSE	TRUE
Two-step control with monopolar control range (0 % ... 100 %)	FALSE	FALSE	FALSE
Manual mode	TRUE	Any	Any

Three-Step Control

In the three-step control mode, the actuating signal can adopt three states. The values of the binary output signals *QPOS_P* and *QNEG_P* are assigned to the statuses of the actuator. The table shows the example of a temperature control:

Output signal	Actuator		
	Heat	Off	Cool
<i>QPOS_P</i>	TRUE	FALSE	FALSE
<i>QNEG_P</i>	FALSE	FALSE	TRUE

Based on the input variable, a characteristic curve is used to calculate a pulse duration. The form of the characteristic curve is defined by the minimum pulse or minimum break time and the ratio factor. The normal value for the ratio factor is 1. The “doglegs” in the curves are caused by the minimum pulse or minimum break times.

- *Minimum Pulse or Minimum Break Time*

A correctly assigned minimum pulse or minimum break time *P_B_TM* can prevent short on/off times that reduce the working life of switching elements and actuators.



*Small absolute values at the input variable LMN that could otherwise generate a pulse duration shorter than *P_B_TM* are suppressed. Large input values that would generate a pulse duration longer than (*PER_TM* - *P_B_TM*) are set to 100 % or -100 %.*

The positive and negative pulse duration is calculated by multiplying the input variable (in %) with the period time:

$$\text{Pulse duration} = \frac{INV}{100} * PER_TM$$

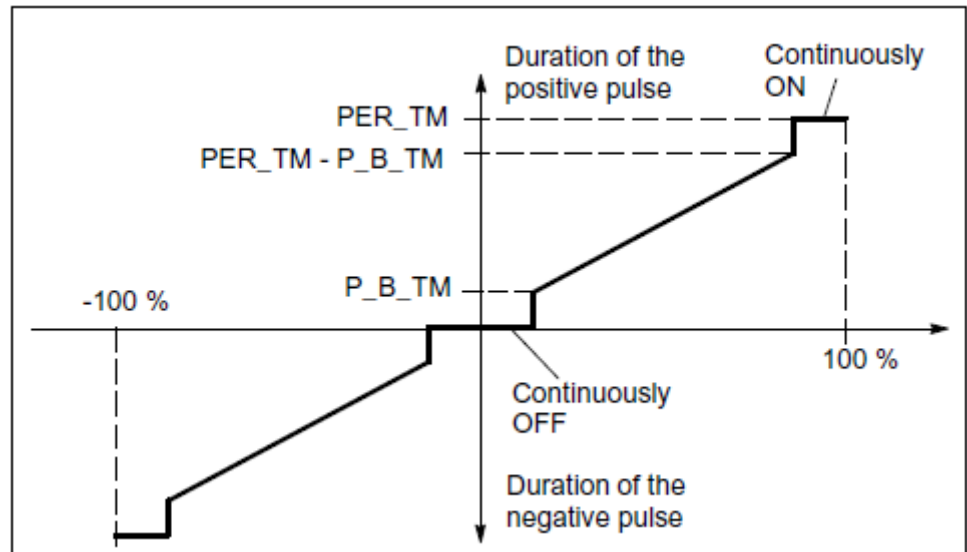

Three-Step Control Asymmetrical

Using the ratio factor *RATIOFAC*, the ratio of the duration of positive to negative pulses can be changed. In a thermal process, for example, this would allow different system time constants for heating and cooling. The ratio factor also influences the minimum pulse or minimum break time. A ratio factor < 1 means that the threshold value for negative pulses is multiplied by the ratio factor.

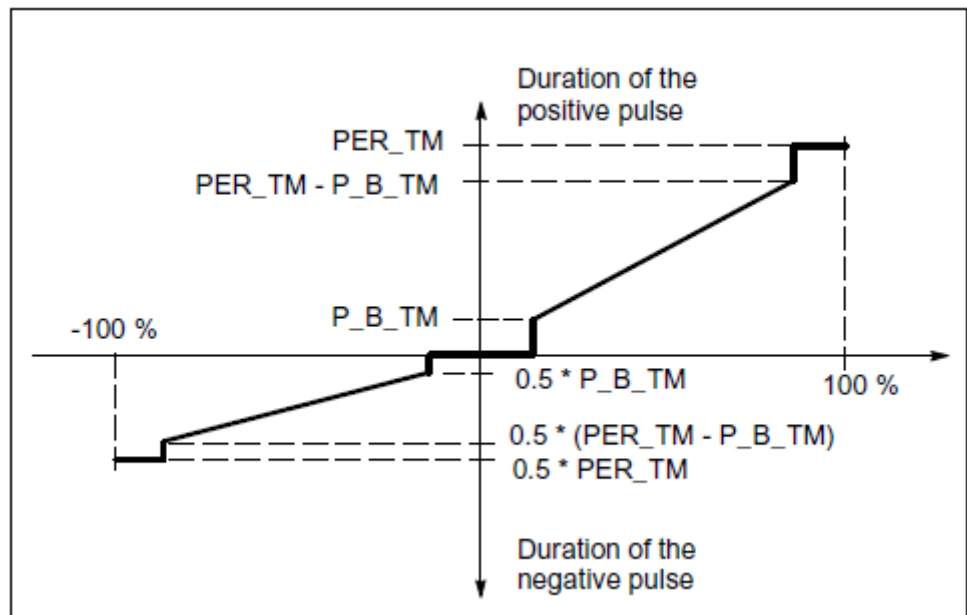

■ **Ratio Factor < 1**

The pulse duration at the negative pulse output calculated from the input variable multiplied by the period time is reduced by the ratio factor.

$$\text{Duration of the positive pulse} = \frac{INV}{100} * PER_TM$$

$$\text{Duration of the negative pulse} = \frac{INV}{100} * PER_TM * RATIOFAC$$

■ *Ratio Factor > 1*

The pulse duration at the positive pulse output calculated from the input variable multiplied by the period time is reduced by the ratio factor.

$$\text{Duration of the negative pulse} = \frac{INV}{100} * PER_TM$$

$$\text{Duration of the positive pulse} = \frac{INV}{100} * \frac{PER_TM}{RATIOFAC}$$

Two-Step Control

In two-step control, only the positive pulse output QPOS_P of PULSGEN is connected to the on/off actuator. Depending on the manipulated value range being used, the two-step controller has a bipolar or a monopolar manipulated value range.

■ *Two-Step Control with Bipolar Manipulated Variable Range (-100 % to 100 %)*

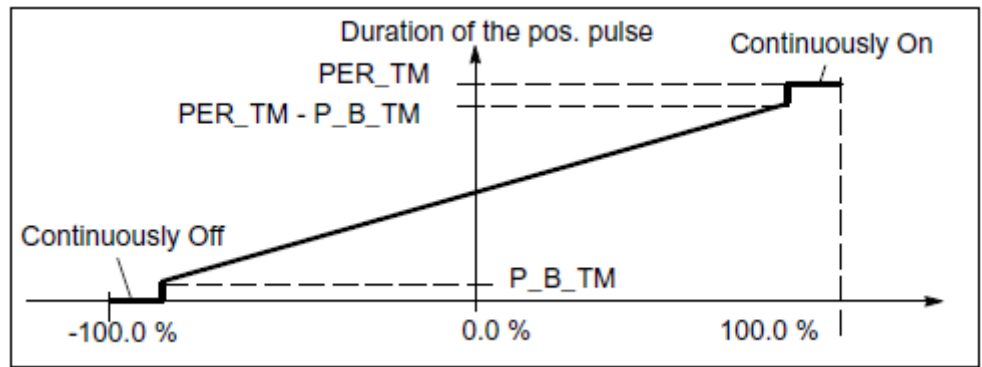

■ *Two-Step Control with Monopolar Manipulated Variable Range (0 % to 100 %)*

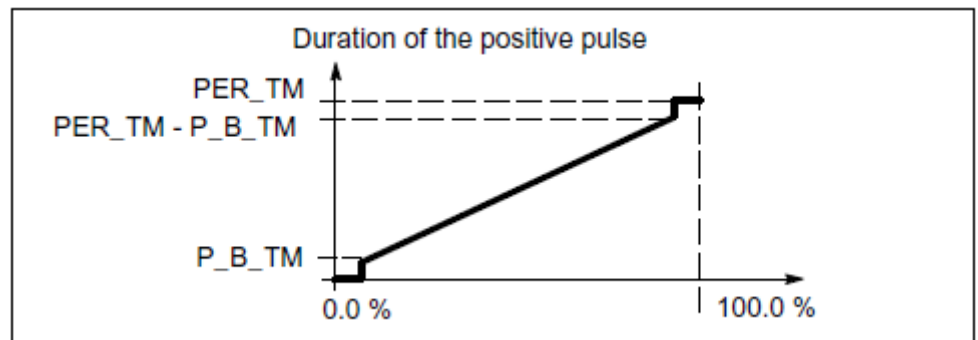

The negated output signal is available at QNEG_P if the connection of the two-step controller in the control loop requires a logically inverted binary signal for the actuating pulses.

Pulse	Actuator	
	On	Off
QPOS_P	TRUE	FALSE
QNEG_P	FALSE	TRUE

Manual Mode in Two/Three-Step Control

In the manual mode (*MAN_ON = TRUE*), the binary outputs of the three-step or two-step controller can be set using the signals *POS_P_ON* and *NEG_P_ON* regardless of *INV*.

	POS_P_ON	NEG_P_ON	QPOS_P	QNEG_P
Three-step control	FALSE	FALSE	FALSE	FALSE
	TRUE	FALSE	TRUE	FALSE
	FALSE	TRUE	FALSE	TRUE
	TRUE	TRUE	FALSE	FALSE
Two-step control	FALSE	Any	FALSE	TRUE
	TRUE	Any	TRUE	FALSE

Modes*Complete Restart/Restart*

- During a complete restart, all the signal outputs are set to 0.

Error Information

The block does not check for errors, so no error Information is output.

15.5.4 FB 58 - TCONT_CP - Continuous Temperature Control**Description**

FB 58 TCONT_CP is used to control temperature processes with continuous or pulsed control signals. You can set parameters to enable or disable subfunctions of the PID controller and adapt it to the process.

Parameters

Parameter	Declaration	Data Type	Description
PV_IN	INPUT	REAL	PROCESS VARIABLE IN <ul style="list-style-type: none"> ■ An initialization value can be set at the <i>PV_IN</i> input or an external process variable in floating-point format can be connected. ■ Default: 0.0 ■ Dependent on the sensors used
PV_PER	INPUT	WORD	PROCESS VARIABLE PERIPHERY <ul style="list-style-type: none"> ■ The process variable in the peripheral I/O format is connected to the controller at the <i>PV_PER</i> input. ■ Default: 0
DISV	INPUT	REAL	DISTURBANCE VARIABLE <ul style="list-style-type: none"> ■ For feed forward control, the disturbance variable is connected to the <i>DISV</i> input. ■ Default: 0.0
INT_HPOS	INPUT	BOOL	INTEGRAL ACTION HOLD IN POSITIVE DIRECTION <ul style="list-style-type: none"> ■ The output of the integral action can be blocked in a positive direction. To achieve this, the <i>INT_HPOS</i> input must be set to TRUE. In a cascade control, the <i>INT_HPOS</i> of the primary controller is interconnected to <i>QLMN_HLM</i> of the secondary controller. ■ Default: FALSE

Parameter	Declaration	Data Type	Description
INT_HNEG	INPUT	BOOL	<p>INTEGRAL ACTION HOLD IN NEGATIVE DIRECTION</p> <ul style="list-style-type: none"> ■ The output of the integral action can be blocked in a positive direction. To achieve this, the <i>INT_HPOS</i> input must be set to TRUE. In a cascade control, the <i>INT_HPOS</i> of the primary controller is interconnected to <i>QLMN_HLM</i> of the secondary controller. ■ Default: FALSE
SELECT	INPUT	BOOL	<p>SELECTION OF CALL PID AND PULSE GENERATOR</p> <ul style="list-style-type: none"> ■ If the pulse generator is activated, there are several ways of calling the PID algorithm and pulse generator: <ul style="list-style-type: none"> – <i>SELECT</i> = 0: The controller is called in a fast cyclic interrupt level and the PID algorithm and pulse generator are processed. – <i>SELECT</i> = 1: The controller is called in OB1 and only the PID algorithm is processed. – <i>SELECT</i> = 2: The controller is called in a fast cyclic interrupt level and only the pulse generator is processed. – <i>SELECT</i> = 3: The controller is called in a slow cyclic interrupt level only the PID algorithm is processed. ■ Default: 0 ■ Range of Values: 0 ... 3
PV	OUTPUT	REAL	<p>PROCESS VARIABLE</p> <ul style="list-style-type: none"> ■ The effective process variable is output at the <i>PV</i> output. ■ Default: 0.0 ■ Range of Values: Dependent on the sensors used
LMN	OUTPUT	REAL	<p>MANIPULATED VALUE</p> <ul style="list-style-type: none"> ■ The effective value of the manipulated variable is output in floating-point format at the <i>LMN</i> output. ■ Default: 0.0
LMN_PER	OUTPUT	WORD	<p>MANIPULATED VALUE PERIPHERY</p> <ul style="list-style-type: none"> ■ The value of the manipulated variable in the peripheral format is connected to the controller at the <i>LMN_PER</i> output. ■ Default: 0
QPULSE	OUTPUT	BOOL	<p>OUTPUT PULSE SIGNAL</p> <ul style="list-style-type: none"> ■ The value of the manipulated variable is output pulse duration modulated at the <i>QPULSE</i> output. ■ Default: FALSE
QLMN_HLM	OUTPUT	BOOL	<p>HIGH LIMIT OF MANIPULATED VALUE REACHED</p> <ul style="list-style-type: none"> ■ The value of the manipulated variable is always limited to an upper and lower limit. The <i>QLMN_HLM</i> output indicates when the upper limit is exceeded. ■ Default: FALSE

Parameter	Declaration	Data Type	Description
QLMN_LLM	OUTPUT	BOOL	<p>LOW LIMIT OF MANIPULATED VALUE REACHED</p> <ul style="list-style-type: none"> The value of the manipulated variable is always limited to an upper and lower limit. The <i>QLMN_LLM</i> output indicates when the lower limit is exceeded. Default: FALSE
QC_ACT	OUTPUT	BOOL	<p>NEXT CYCLE, THE CONTINUOUS CONTROLLER IS WORKING</p> <ul style="list-style-type: none"> This parameter indicates whether or not the continuous controller stage will be executed at the next block call (relevant only when <i>SELECT</i> has the value 0 or 1). Default: TRUE
CYCLE	INPUT/ OUTPUT	REAL	<p>SAMPLE TIME OF CONTINUOUS CONTROLLER [s]</p> <ul style="list-style-type: none"> This sets the sampling time for the PID algorithm. The tuner calculates the sampling time in Phase 1 and enters this in <i>CYCLE</i>. Default: 0.1s Range of Values: ≥ 1ms
CYCLE_P	INPUT/ OUTPUT	REAL	<p>SAMPLE TIME OF PULSE GENERATOR [s]</p> <ul style="list-style-type: none"> At this input, you enter the sampling time for the pulse generator stage. FB 58 "TCONT_CP" calculates the sampling time in Phase 1 and enters it in <i>CYCLE_P</i>. Default: 0.2s Range of Values: ≥ 1ms
SP_INT	INPUT/ OUTPUT	REAL	<p>INTERNAL SETPOINT</p> <ul style="list-style-type: none"> The <i>SP_INT</i> input is used to specify a setpoint. Default: 0.0 Range of Values: Value range of the process value
MAN	INPUT/ OUTPUT	REAL	<p>MANUAL VALUE</p> <ul style="list-style-type: none"> The <i>MAN</i> input is used to specify a manual value. In automatic mode, it is corrected to the manipulated variable. Default: 0.0
COM_RST	INPUT/ OUTPUT	REAL	<p>COMPLETE RESTART</p> <ul style="list-style-type: none"> The block has an initialization routine that is processed when the <i>COM_RST</i> input is set. Default: FALSE
MAN_ON	INPUT/ OUTPUT	REAL	<p>MANUAL OPERATION ON</p> <ul style="list-style-type: none"> If the <i>MAN_ON</i> input is set, the control loop is interrupted. The <i>MAN</i> manual value is set as the value of the manipulated variable. Default: TRUE

Internal Parameters

Parameter	Declaration	Data type	Description
DEADB_W	INPUT	REAL	<p>DEAD BAND WIDTH</p> <ul style="list-style-type: none"> The error passes through a dead band. The <i>DEADB_W</i> input decides the size of the dead band. Default: 0.0 Range of Values: Dependent on the sensors used
I_ITLVAL	INPUT	REAL	<p>INITIALIZATION VALUE OF THE INTEGRAL ACTION</p> <ul style="list-style-type: none"> The output of the integral action can be set at the <i>I_ITL_ON</i> input. The initialization value is applied to the <i>I_ITLVAL</i> input. During a restart <i>COM_RST</i> = TRUE, the I action is set to the initialization value. Default: 0.0 Range of Values: 0 to 100 %
LMN_HLM	INPUT	REAL	<p>MANIPULATED VARIABLE HIGH LIMIT</p> <ul style="list-style-type: none"> The value of the manipulated variable is always limited to an upper and lower limit. The <i>LMN_HLM</i> input specifies the upper limit. Default: 100.0 Range of Values: > <i>LMN_LLM</i>
LMN_LLM	INPUT	REAL	<p>MANIPULATED VARIABLE LOW LIMIT</p> <ul style="list-style-type: none"> The value of the manipulated variable is always limited to an upper and lower limit. The <i>LMN_LLM</i> input specifies the lower limit. Default: 0.0 Range of Values: < <i>LMN_HLM</i>
PV_FAC	INPUT	REAL	<p>PROCESS VARIABLE FACTOR</p> <ul style="list-style-type: none"> The <i>PV_FAC</i> input is multiplied by the <i>PV_PER</i>. The input is used to adapt the process variable range. Default: 1.0
PV_OFFS	INPUT	REAL	<p>PROCESS VARIABLE OFFSET</p> <ul style="list-style-type: none"> The <i>PV_OFFS</i> input is added to the <i>PV_PER</i>. The input is used to adapt the process variable range. Default: 0.0
LMN_FAC	INPUT	REAL	<p>MANIPULATED VARIABLE FACTOR</p> <ul style="list-style-type: none"> The <i>LMN_FAC</i> input is multiplied by the manipulated variable. The input is used to adapt the manipulated variable range. Default: 1.0
LMN_OFFS	INPUT	REAL	<p>MANIPULATED VARIABLE OFFSET</p> <ul style="list-style-type: none"> The <i>LMN_OFFS</i> input is added to the value of the manipulated variable. The input is used to adapt the manipulated variable range. Default: 0.0

Parameter	Declaration	Data type	Description
PER_TM	INPUT	REAL	<p>PERIOD TIME [s]</p> <ul style="list-style-type: none"> The pulse repetition period of the pulse duration modulation is entered at the <i>PER_TM</i> parameter. The relationship of the pulse repetition period to the sampling time of the pulse generator decides the accuracy of the pulse duration modulation. Default: 1.0 s Range of Values: \geq <i>CYCLE</i>
P_B_TM	INPUT	REAL	<p>MINIMUM PULSE/BREAK TIME [s]</p> <ul style="list-style-type: none"> A minimum pulse or minimum break time can be set at the <i>P_B_TM</i> parameter. <i>P_B_TM</i> is limited internally to $>$ <i>CYCLE_P</i>. Default: 0.02 s Range of Values: \geq 0.0
TUN_DLMN	INPUT	REAL	<p>DELTA MANIPULATED VARIABLE FOR PROCESS EXCITATION</p> <ul style="list-style-type: none"> Process excitation for controller tuning results from a setpoint step change at <i>TUN_DLMN</i>. Default: 20.0 Range of Values: -100.0 ... 100.0 %
PER_MODE	INPUT	INT	<p>PERIPHERY MODE</p> <ul style="list-style-type: none"> You can enter the type of the I/O module at this switch. The process variable at input <i>PV_PER</i> is then normalized to °C at the <i>PV</i> output. <ul style="list-style-type: none"> <i>PER_MODE</i> = 0: standard <i>PER_MODE</i> = 1: climate <i>PER_MODE</i> = 2: current/voltage Default: 0 Range of Values: 0, 1, 2
PVPER_ON	INPUT	BOOL	<p>PROCESS VARIABLE PERIPHERY ON</p> <ul style="list-style-type: none"> If you want the process variable to be read in from the I/O, the <i>PV_PER</i> input must be connected to the I/O and the <i>PVPER_ON</i> input must be set. Default: FALSE
I_ITL_ON	INPUT	BOOL	<p>INITIALIZATION OF THE INTEGRAL ACTION ON</p> <ul style="list-style-type: none"> The output of the integral action can be set to the <i>I_ITLVAL</i> input. The <i>I_ITL_ON</i> input must be set. Default: FALSE
PULSE_ON	INPUT	BOOL	<p>PULSE GENERATOR ON</p> <ul style="list-style-type: none"> If <i>PULSE_ON</i> = TRUE is set, the pulse generator is activated Default: FALSE
TUN_KEEP	INPUT	BOOL	<p>KEEP TUNING ON</p> <ul style="list-style-type: none"> The mode changes to automatic only when <i>TUN_KEEP</i> changes to FALSE. Default: FALSE

Parameter	Declaration	Data type	Description
ER	OUTPUT	REAL	<p>ERROR SIGNAL</p> <ul style="list-style-type: none"> The effective error is output at the <i>ER</i> output. Default: 0.0 Range of Values: Dependent on the sensors used
LMN_P	OUTPUT	REAL	<p>PROPORTIONALITY COMPONENT</p> <ul style="list-style-type: none"> The <i>LMN_P</i> contains the proportional action of the manipulated variable. Default: 0.0
LMN_I	OUTPUT	REAL	<p>INTEGRAL COMPONENT</p> <ul style="list-style-type: none"> The <i>LMN_I</i> contains the integral action of the manipulated variable. Default: 0.0
LMN_D	OUTPUT	REAL	<p>DERIVATIVE COMPONENT</p> <ul style="list-style-type: none"> The <i>LMN_D</i> contains the derivative action of the manipulated variable. Default: 0.0
PHASE	OUTPUT	INT	<p>PHASE OF SELF TUNING</p> <ul style="list-style-type: none"> The current phase of the controller tuning is indicated at the <i>PHASE</i> output (0...7). Default: 0 Range of Values: 0, 1, 2, 3, 4, 5, 7
STATUS_H	OUTPUT	INT	<p>STATUS HEATING OF SELF TUNING</p> <ul style="list-style-type: none"> <i>STATUS_H</i> indicates the diagnostic value of the search for the point of inflection when heating. Default: 0
STATUS_D	OUTPUT	INT	<p>STATUS CONTROLLER DESIGN OF SELF TUNING</p> <ul style="list-style-type: none"> <i>STATUS_D</i> indicated the diagnostic value of the controller design when heating. Default: 0
QTUN_RUN	OUTPUT	BOOL	<p>TUNING IS ACTIVE (PHASE 2)</p> <ul style="list-style-type: none"> The tuning manipulated variable has been applied, tuning has started and is still in phase 2 (locating the point of inflection). Default: 0
PI_CON	OUTPUT	STRUCT	PI CONTROLLER PARAMETERS
GAIN	OUTPUT	REAL	<p>PI PROPORTIONAL GAIN</p> <ul style="list-style-type: none"> Default: 0.0 Range of Values: % / phys. unit
TI	OUTPUT	REAL	<p>PI RESET TIME [s]</p> <ul style="list-style-type: none"> Default: 0.0 s Range of Values: ≥ 0.0 s
PID_CON	OUTPUT	STRUCT	PID CONTROLLER PARAMETERS/ PID Reglerparameter

Parameter	Declaration	Data type	Description
GAIN	OUTPUT	REAL	PID PROPORTIONAL GAIN <ul style="list-style-type: none"> Default: 0.0
TI	OUTPUT	REAL	PID RESET TIME [s] <ul style="list-style-type: none"> Default: 0.0 s Range of Values: ≥ 0.0 s
TD	OUTPUT	REAL	PID DERIVATIVE TIME [s] <ul style="list-style-type: none"> Default: 0.0 s Range of Values: ≥ 0.0 s
PAR_SAVE	OUTPUT	STRUCT	SAVED CONTROLLER PARAMETERS <ul style="list-style-type: none"> The PID parameters are saved in this structure.
PFAC_SP	INPUT/ OUTPUT	REAL	PROPORTIONAL FACTOR FOR SETPOINT CHANGES <ul style="list-style-type: none"> Default: 1.0 Range of Values: 0.0 ... 1.0
GAIN	OUTPUT	REAL	PROPORTIONAL GAIN <ul style="list-style-type: none"> Default: 0.0 Range of Values: % / phys. unit
TI	INPUT/ OUTPUT	REAL	RESET TIME [s] <ul style="list-style-type: none"> Default: 40.0 s Range of Values: ≥ 0.0 s
TD	INPUT/ OUTPUT	REAL	DERIVATIVE TIME [s] <ul style="list-style-type: none"> Default: 10.0 s Range of Values: ≥ 0.0 s
D_F	OUTPUT	REAL	DERIVATIVE FACTOR <ul style="list-style-type: none"> Default: 5.0 Range of Values: 5.0 ... 10.0
CON_ZONE	OUTPUT	REAL	CONTROL ZONE ON <ul style="list-style-type: none"> Default: 100.0 Range of Values: ≥ 0.0
CONZ_ON	OUTPUT	REAL	CONTROL ZONE <ul style="list-style-type: none"> Default: FALSE
PFAC_SP	INPUT/ OUTPUT	REAL	PROPORTIONAL FACTOR FOR SETPOINT CHANGES <ul style="list-style-type: none"> <i>PFAC_SP</i> specifies the effective P action when there is a setpoint change. This is set between 0 and 1. <ul style="list-style-type: none"> 1: P action has full effect if the setpoint changes. 0: P action has no effect if the setpoint changes. Default: 1.0 Range of Values: 0.0 ... 1.0

Parameter	Declaration	Data type	Description
GAIN	INPUT/ OUTPUT	REAL	<p>PROPORTIONAL GAIN</p> <ul style="list-style-type: none"> ■ The <i>GAIN</i> input specifies the controller gain. The direction of control can be reversed by giving <i>GAIN</i> a negative sign. ■ Default: 0.0 ■ Range of Values: % / phys. Value
TI	INPUT/ OUTPUT	REAL	<p>RESET TIME [s]</p> <ul style="list-style-type: none"> ■ The <i>TI</i> input (integral time) decides the integral action response. ■ Default: 40.0 s ■ Range of Values: ≥ 0.0 s
TD	INPUT/ OUTPUT	REAL	<p>DERIVATIVE TIME [s]</p> <ul style="list-style-type: none"> ■ The <i>TD</i> input decides the derivative action response. ■ Default: 10.0 s ■ Range of Values: ≥ 0.0 s
D_F	INPUT/ OUTPUT	REAL	<p>DERIVATIVE FACTOR</p> <ul style="list-style-type: none"> ■ The derivative factor <i>D_F</i> decides the lag of the D-action. <ul style="list-style-type: none"> – $D_F = \text{derivative time} / \text{"lag of the D-action"}$ ■ Default: 5.0 ■ Range of Values: 5.0 ... 10.0
CON_ZONE	INPUT/ OUTPUT	REAL	<p>CONTROL ZONE ON</p> <ul style="list-style-type: none"> ■ If the error is greater than the control zone width <i>CON_ZONE</i>, the upper manipulated variable limit is output as the manipulated variable. ■ If the error is less than the negative control zone width, the lower manipulated variable limit is output as the manipulated variable. ■ Default: 100.0 ■ Dependent on the sensors used
CONZ_ON	INPUT/ OUTPUT	BOOL	<p>CONTROL ZONE</p> <ul style="list-style-type: none"> ■ <i>CONZ_ON</i> = TRUE activates the control zone. ■ Default: FALSE
TUN_ON	INPUT/ OUTPUT	BOOL	<p>SELF TUNING ON</p> <ul style="list-style-type: none"> ■ If <i>TUN_ON</i> = TRUE is set, the manipulated value is averaged until the manipulated variable excitation <i>TUN_DLMN</i> is activated either by a setpoint step change or by <i>TUN_ST</i> = TRUE. ■ Default: FALSE
TUN_ST	INPUT/ OUTPUT	BOOL	<p>START SELF TUNING</p> <ul style="list-style-type: none"> ■ If the setpoint is to remain constant during controller tuning at the operating point, a manipulated variable step change by the amount of <i>TUN_DLMN</i> is activated by <i>TUN_ST</i> = TRUE. ■ Default: FALSE

Parameter	Declaration	Data type	Description
UNDO_PAR	INPUT/ OUTPUT	BOOL	<p>UNDO CHANGE OF CONTROLLER PARAMETERS</p> <ul style="list-style-type: none"> Loads the controller parameters <i>PFAC_SP</i>, <i>GAIN</i>, <i>TI</i>, <i>TD</i>, <i>D_F</i>, <i>CONZ_ON</i> and <i>CON_ZONE</i> from the data structure <i>PAR_SAVE</i> (only in manual mode). Default: FALSE
SAVE_PAR	INPUT/ OUTPUT	BOOL	<p>SAVE CURRENT CONTROLLER PARAMETERS</p> <ul style="list-style-type: none"> Saves the controller parameters <i>PFAC_SP</i>, <i>GAIN</i>, <i>TI</i>, <i>TD</i>, <i>D_F</i>, <i>CONZ_ON</i> and <i>CON_ZONE</i> in the data structure <i>PAR_SAVE</i>. Default: FALSE
LOAD_PID	INPUT/ OUTPUT	BOOL	<p>LOAD OPTIMIZED PI/PID PARAMETERS</p> <ul style="list-style-type: none"> Loads the controller parameters <i>GAIN</i>, <i>TI</i>, <i>TD</i> depending on <i>PID_ON</i> from the data structure <i>PI_CON</i> or <i>PID_CON</i> (only in manual mode) Default: FALSE
PID_ON	INPUT/ OUTPUT	BOOL	<p>PID MODE ON</p> <ul style="list-style-type: none"> At the <i>PID_ON</i> input, you can specify whether or not the tuned controller will operate as a PI or PID controller. <ul style="list-style-type: none"> PID controller: <i>PID_ON</i> = TRUE PI controller: <i>PID_ON</i> = FALSE It is nevertheless possible that with certain process types, only a PI controller will be designed despite <i>PID_ON</i> = TRUE. Default: TRUE
GAIN_P	OUTPUT	REAL	<p>PROZESS PROPORTIONAL GAIN</p> <ul style="list-style-type: none"> Identified process gain. For the process type I, <i>GAIN_P</i> tends to be estimated too low. Default: 0.0
TU	OUTPUT	REAL	<p>DELAY TIME [s]</p> <ul style="list-style-type: none"> Identified delay of the process. Default: 0.0 Range of Values: $\geq 3 \cdot \text{CYCLE}$
TA	OUTPUT	REAL	<p>RECOVERY TIME [s]</p> <ul style="list-style-type: none"> Identified system time constant of the process. For the process type I, <i>TA</i> tends to be estimated too low. Default: 0.0
KIG	OUTPUT	REAL	<p>MAXIMAL ASCENT RATIO OF PV WITH 100 % LMN CHANGE</p> <ul style="list-style-type: none"> $GAIN_P = 0.01 \cdot KIG \cdot TA$ Default: 0.0
N_PTN	OUTPUT	REAL	<p>PROCESS ORDER</p> <ul style="list-style-type: none"> The parameter specifies the order of the process. "Non-integer values" are also possible. Default: 0.0 Range of Values: 1.01 to 10.0

Parameter	Declaration	Data type	Description
TM_LAG_P	OUTPUT	REAL	TIME LAG OF PTN MODEL [s] <ul style="list-style-type: none"> Time lag of PTN model (values only for $N_{PTN} \geq 2$). Default: 0.0
T_P_INF	OUTPUT	REAL	TIME TO POINT OF INFLECTION [s] <ul style="list-style-type: none"> Time from process excitation until the point of inflection. Default: 0.0
P_INF	OUTPUT	REAL	PV AT POINT OF INFLECTION - PV0 <ul style="list-style-type: none"> Process variable change from process excitation until the point of inflection. Default: 0.0 Range of Values: Value range of the process value
LMN0	OUTPUT	REAL	MANIPULATED VAR. AT BEGIN OF TUNING <ul style="list-style-type: none"> Detected in phase 1 (mean value). Default: 0.0 Range of Values: 0 ... 100 %
PV0	OUTPUT	REAL	PROCESS VALUE AT BEGIN OF TUNING <ul style="list-style-type: none"> Default: 0.0 Range of Values: Value range of the process value
PVDT0	OUTPUT	REAL	RATE OF CHANGE OF PV AT BEGIN OF TUNING [1/s] <ul style="list-style-type: none"> Sign adapted Default: 0.0
PVDT	OUTPUT	REAL	CURRENT RATE OF CHANGE OF PV [1/s] <ul style="list-style-type: none"> Sign adapted Default: 0.0
PVDT_MAX	OUTPUT	REAL	MAX. RATE OF CHANGE OF PV PER SECOND [1/s] <ul style="list-style-type: none"> Maximum rate of change of the process variable at the point of inflection at the (sign adapted, always > 0), used to calculate TU and KIG. Default: 0.0
NOI_PVDT	OUTPUT	REAL	RATIO OF NOISE IN PVDT_MAX IN % <ul style="list-style-type: none"> The higher the proportion of noise, less accurate (less aggressive) the control parameters. Default: 0.0
NOISE_PV	OUTPUT	REAL	ABSOLUTE NOISE IN PV <ul style="list-style-type: none"> Difference between maximum and minimum process variable in phase 1. Default: 0.0

Parameter	Declaration	Data type	Description
FIL_CYC	OUTPUT	INT	NO OF CYCLES FOR MEAN-VALUE FILTER <ul style="list-style-type: none"> ■ The process variable is averaged over <i>FIL_CYC</i> cycles. When necessary, <i>FIL_CYC</i> is increased automatically from 1 to a maximum of 1024. ■ Default: 1 ■ Range of Values: 1 ... 1024
POI_CMAX	OUTPUT	INT	MAX NO OF CYCLES AFTER POINT OF INFLECTION <ul style="list-style-type: none"> ■ This time is used to find a further (in other words better) point of inflection when measurement noise is present. The tuning is completed only after this time. ■ Default: 2
POI_CYCL	OUTPUT	INT	NUMBER OF CYCLES AFTER POINT OF INFLECTION <ul style="list-style-type: none"> ■ Default: 0

Application

- The functionality is based on the PID control algorithm with additional functions for temperature processes. The controller supplies analog manipulated values and pulse-duration modulated actuating signals. The controller outputs signals to one actuator; in other words, with one controller, you can either heat or cool but not both.
- FB 58 TCONT_CP can be used either purely for heating or purely for cooling. If you use the block for cooling, *GAIN* must be assigned a negative value. This inversion of the controller means that, for example if the temperature rises, the manipulated variable *LMN* and with it the cooling effort is increased.
- Apart from the functions in the setpoint and process value branches, the FB implements a complete PID temperature controller with a continuous and binary manipulated variable output. To improve the control response with temperature processes, the block includes a control zone and reduction of the P-action if there is a setpoint step change. The block can set the PI/PID parameters itself using the controller tuning function.



The values in the controller blocks are only calculated correctly if the block is called at regular intervals. Therefore, you have to call the controller blocks in a cyclic interrupt OB (OB 30 ... 38) at regular intervals. The sampling time is predefined on the parameter CYCLE.

Setpoint Branch

The setpoint is entered at input *SP_INT* in floating-point format as a physical value or percentage. The setpoint and process value used to form the error must have the same unit.

Process Value Options (*PVPER_ON*)

Depending on *PVPER_ON*, the process value can be acquired in the peripheral (I/O) or floating-point format.

<i>PVPER_ON</i>	Process Value Input
TRUE	The process value is read in via the analog peripheral I/Os (PIW xxx) at input <i>PV_PER</i> .
FALSE	The process value is acquired in floating-point format at input <i>PV_IN</i> .

Process Value Format Conversion CRP_IN (PER_MODE)

The CRP_IN function converts the peripheral value PV_PER to a floating-point format depending on the switch PER_MODE according to the following rules:

PER_MODE	Output of CRP_IN	Analog Input Type	Unit
0	$PV_PER * 0.1$	Thermoelements; PT100/NI100; standard	°C; °F
1	$PV_PER * 0.01$	PT100/NI100; climate	°C; °F
2	$PV_PER * 100/27648$	Voltage/current	%

Process Value Normalization PV_NORM (PV_FAC , PV_OFFS)

The PV_NORM function calculates the output of CRP_IN according to the following rule:
 $Output\ of\ PV_NORM = Ausgang\ von\ CPR_IN * PV_FAC + PV_OFFS$

It can be used for the following purposes:

- Process value correction with PV_FAC as the process value factor and PV_OFFS as the process value offset.
- Normalization of temperature to percentage
You want to enter the setpoint as a percentage and must now convert the measured temperature value to a percentage.
- Normalization of percentage to temperature
You want to enter the setpoint in the physical temperature unit and must now convert the measured voltage/current value to a temperature.

Calculation of the parameters:

- $PV_FAC = range\ of\ PV_NORM / range\ of\ CRP_IN$
- $PV_OFFS = LL(PV_NORM) - PV_FAC * LL(CRP_IN)$; where LL is the lower limit

With the default values ($PV_FAC = 1.0$ and $PV_OFFS = 0.0$), normalization is disabled. The effective process value is output at the PV output.



With pulse control, the process value must be transferred to the block in the fast pulse call (reason: mean value filtering). Otherwise, the control quality can deteriorate.

Example of Process Variable Normalization

If you want to enter the setpoint as a percentage, and you have a temperature range of -20 ... 85 °C applied to CRP_IN , you must normalize the temperature range as a percentage. The schematic below shows an example of adapting the temperature range -20 ... 85 °C to an internal scale of 0 ... 100 %:

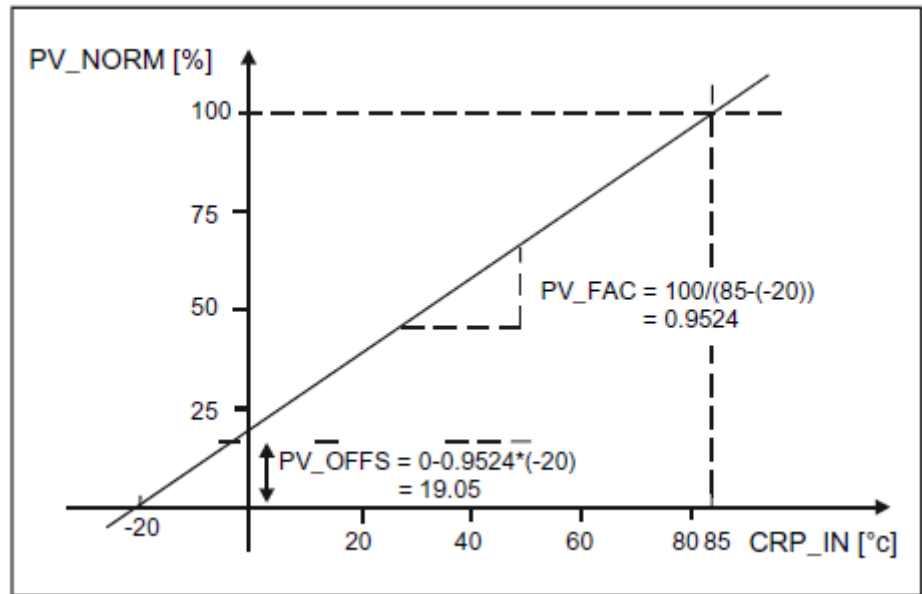

Forming the Error

The difference between the setpoint and process value is the error before the deadband. The setpoint and process value must exist in the same unit.

Deadband (DEADB_W)

To suppress a small constant oscillation due to the manipulated variable quantization (for example in pulse duration modulation with PULSEGEN) a deadband (DEADBAND) is applied to the error. If DEADB_W = 0.0, the deadband is deactivated. The effective error is indicated by the ER parameter.

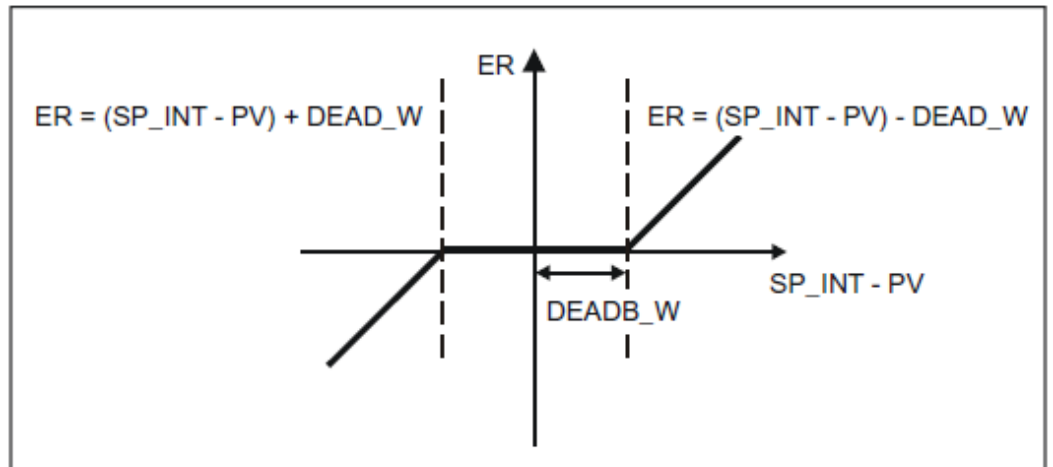

PID Algorithm

The schematic below is the block diagram of the PID algorithm:

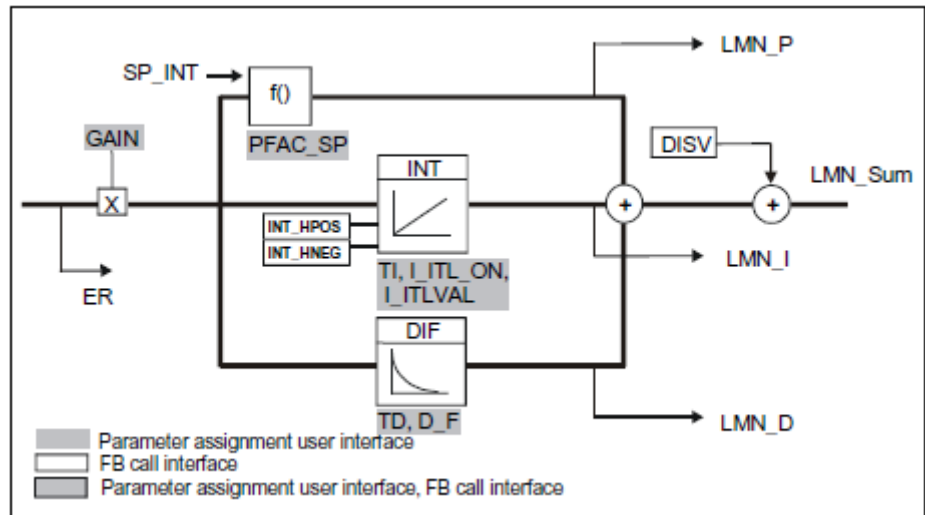

PID Algorithm (GAIN, TI, TD, D_F)

- The PID algorithm operates as a position algorithm. The proportional, integral (INT), and derivative (DIF) actions are connected in parallel and can be activated or deactivated individually. This allows P, PI, PD, and PID controllers to be configured.
- The controller tuning supports PI and PID controllers. Controller inversion is implemented using a negative GAIN (cooling controller).
- If you set TI and TD to 0.0, you obtain a pure P controller at the operating point.

$$LMN_Sum(t) = GAIN * ER(0) \left(1 + \frac{I}{TI} * t + D_F * e^{-\frac{t}{TD/D_F}} \right)$$

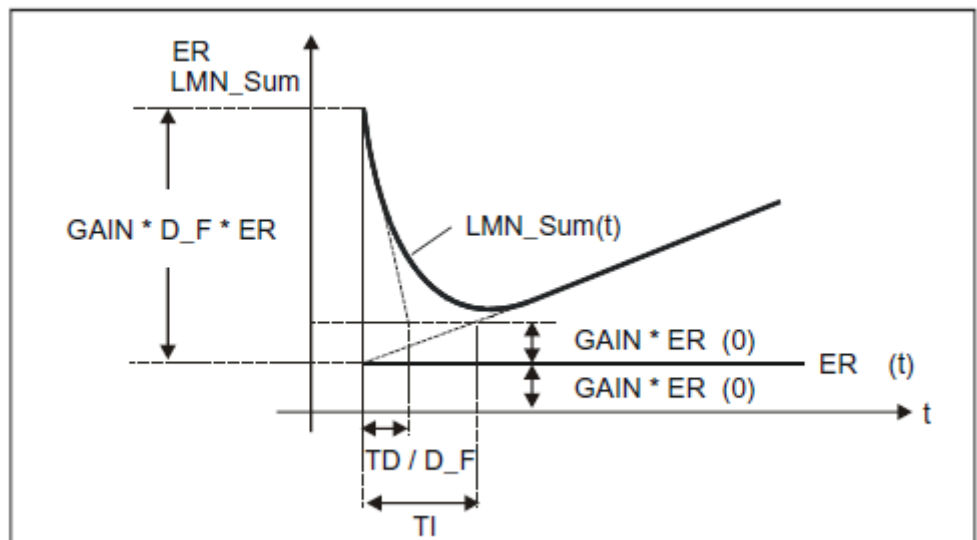

LMN_Sum(t) manipulated variable in automatic mode of the controller
 ER(0) step change of the normalized error
 GAIN controller gain
 TI integral time
 TD derivative time
 D_F derivative factor

Integrator (TI, I_ITL_ON, I_ITLVAL)

In the manual mode, it is corrected as follows: $LMN_I = LMN - LMN_P - DISV$

If the manipulated variable is limited, the I-action is stopped. If the error moves the I-action back in the direction of the manipulated variable range, the I-action is enabled again.

The I-action is also modified by the following measures:

- The I-action of the controller is deactivated by $TI = 0.0$
- Weakening the P-action when setpoint changes occur
- Control zone
- The limits of the manipulated variable can be changed online

Weakening the P-Action when Setpoint Changes Occur (PFAC_SP)

To prevent overshoot, you can weaken the P-action using the "proportional factor for setpoint changes" parameter (PFAC_SP). Using PFAC_SP, you can select continuously between 0.0 and 1.0 to decide the effect of the P-action when the setpoint changes:

- PFAC_SP = 1.0: P-action has full effect if the setpoint changes
- PFAC_SP = 0.0: P-action has no effect if the setpoint changes

The weakening of the P-action is achieved by compensating the I-action.

Derivative Action Element (TD, D_F)

- The D-action of the controller is deactivated with $TD = 0.0$.
- If the D-action is active, the following relationship should apply: $TD = 0.5 * CYCLE * D_F$

Parameter Settings of a P or PD Controller with Operating Point

In the user interface, deactivate the I-action ($TI = 0.0$) and possible also the D-action ($TD = 0.0$). Then make the following parameter settings:

- I_ITL_ON = TRUE
- I_ITLVAL = operating point;

Feedforward Control (DISV)

A feedforward variable can be added at the DISV input.

Calculating the Manipulated Variable

The schematic below is the block diagram of the manipulated variable calculation:

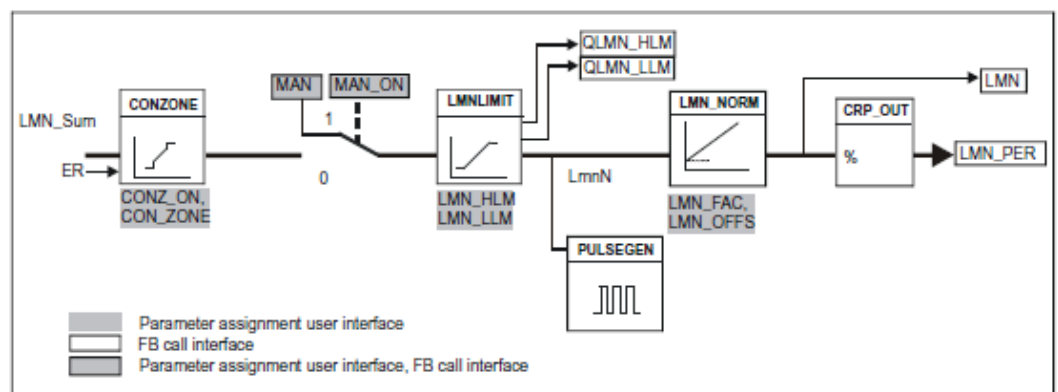

Control Zone (CONZ_ON, CON_ZONE)

If CONZ_ON = TRUE, the controller operates with a control zone. This means that the controller operates according to the following algorithm:

- If PV exceeds SP_INT by more than CON_ZONE, the value LMN_LLM is output as the manipulated variable (controlled closed-loop).
- If PV falls below SP_INT by more than CON_ZONE, the value LMN_HLM is output as the manipulated variable (controlled closed-loop).
- If PV is within the control zone (CON_ZONE), the manipulated variable takes its value from the PID algorithm LMN_Sum (automatic closed-loop control).



The changeover from controlled closed-loop to automatic closed-loop control takes into account a hysteresis of 20% of the control zone.

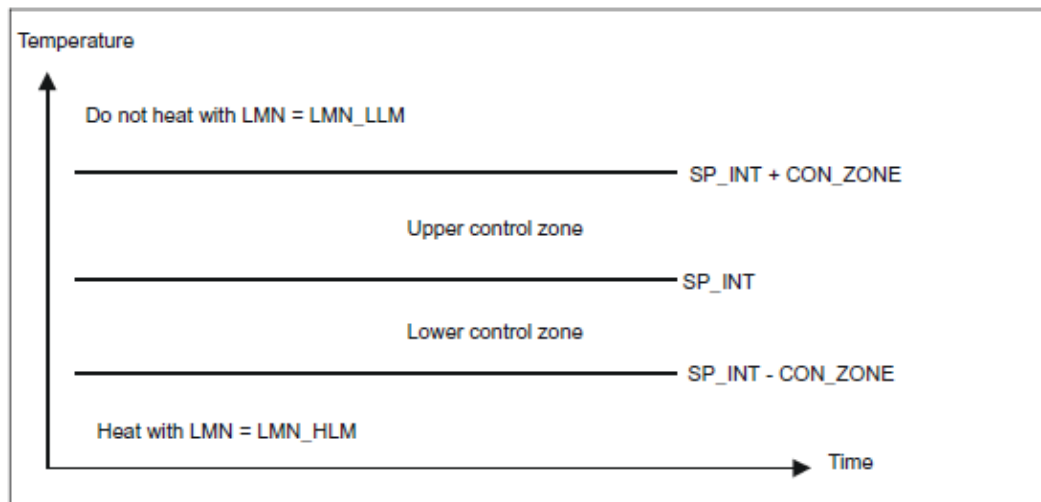

Before activating the control zone manually, make sure that the control zone band is not too narrow. If the control zone band is too small, oscillations will occur in the manipulated variable and process variable.

Advantage of the Control Zone

When the process value enters the control zone, the D-action causes an extremely fast reduction of the manipulated variable. This means that the control zone is only useful when the D-action is activated. Without a control zone, basically only the reducing P-action would reduce the manipulated variable. The control zone leads to faster settling without overshoot or undershoot if the output minimum or maximum manipulated variable is a long way from the manipulated variable required for the new operating point.

Manual Value Processing (MAN_ON, MAN)

You can switch over between manual and automatic operation. In the manual mode, the manipulated variable is corrected to a manual value. The integral action (INT) is set internally to $LMN - LMN_P - DISV$ and the derivative action (DIF) is set to 0 and synchronized internally. Switching over to automatic mode is therefore bumpless.



During tuning, the MAN_ON parameter has no effect.

Manipulated Variable Limitation LMNLIMIT (LMN_HLM, LMN_LLM)

The value of the manipulated variable is limited to the LMN_HLM and LMN_LLM limits by the $LMNLIMIT$ function. If these limits are reached, this is indicated by the message bits $QLMN_HLM$ and $QLMN_LLM$. If the manipulated variable is limited, the I-action is stopped. If the error moves the I-action back in the direction of the manipulated variable range, the I-action is enabled again.

Changing the Manipulated Variable Limits Online

If the range of the manipulated variable is reduced and the new unlimited value of the manipulated variable is outside the limits, the I-action and therefore the value of the manipulated variable shifts. The manipulated variable is reduced by the same amount as the manipulated variable limit changed. If the manipulated variable was unlimited prior to the change, it is set exactly to the new limit (described here for the upper manipulated variable limit).

Manipulated Variable Normalization *LMN_NORM* (*LMN_FAC*, *LMN_OFFS*)

- The *LMN_NORM* function normalizes the manipulated variable according to the following formula:
 $LMN = LmnN * LMN_FAC + LMN_OFFS$
- It can be used for the following purposes:
 Manipulated variable adaptation with *LMN_FAC* as manipulated variable factor and *LMN_OFFS* manipulated variable offset
- The value of the manipulated variable is also available in the peripheral format. The *CRP_OUT* function converts the *LMN* floating-point value to a peripheral value according to the following formula:
 $LMN_PER = LMN * 27648/100$
 With the default values (*LMN_FAC* = 1.0 and *LMN_OFFS* = 0.0), normalization is disabled. The effective manipulated variable is output at output *LMN*.

Saving and Reloading Controller Parameters

The schematic below shows the block diagram:

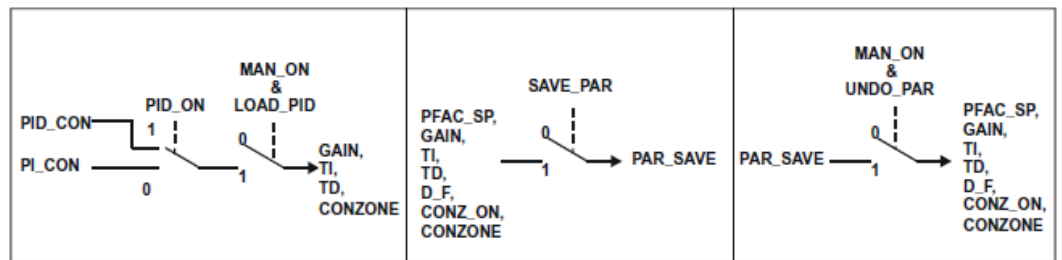

Saving Controller Parameters *SAVE_PAR*

If the current parameter settings are usable, you can save them in a special structure in the instance DB of FB 58 TCONT_CP prior to making a manual change. If you tune the controller, the saved parameters are overwritten by the values that were valid prior to tuning. *PFAC_SP*, *GAIN*, *TI*, *TD*, *D_F*, *CONZ_ON* and *CON_ZONE* are written to the *PAR_SAVE* structure.

Reloading Saved Controller Parameters *UNDO_PAR*

The last controller parameter settings you saved can be activated for the controller again using this function (in manual mode only).

Changing Between PI and PID Parameters *LOAD_PID* (*PID_ON*)

Following tuning, the PI and PID parameters are stored in the *PI_CON* and *PID_CON* structures. Depending on *PID_ON*, you can use *LOAD_PID* in the manual mode to write the PI or PID parameters to the effective controller parameters.

PID parameter <i>PID_ON</i> = TRUE		PI parameter <i>PID_ON</i> = FALSE	
GAIN	= PID_CON.GAIN	GAIN	= PI_CON.GAIN
TI	= PID_CON.TI	TI	= PI_CON.TI
TD	= PID_CON.TD		



- The controller parameters are only written back to the controller with `UNDO_PAR` or `LOAD_PID` when the controller gain is not 0:
For `LOAD_PID`, the parameters are only copied if the respective `GAIN <> 0` (either from the PI or PID parameter set). This takes into account the case that no optimization has yet been performed or PID parameters are missing. If `PID_ON = TRUE` and `PID.GAIN = FALSE`, `PID_ON` is set to `FALSE` and the PI parameters are copied.
- `D_F`, `PFAC_SP` are set to default values by the tuning. These can then be modified by the user. `LOAD_PID` does not change these parameters.
- With `LOAD_PID`, the control zone is always recalculated (`CON_ZONE = 250/GAIN`) even when `CONZ_ON = FALSE` is set.

15.5.5 FB 59 - TCONT_S - Temperature Step Control

Description

FB 59 TCONT_S is used to control technical temperature processes with binary controller output signals for integrating actuators. By setting parameters, subfunctions of the PI step controller can be activated or deactivated and the controller adapted to the process.

Parameters

Parameter	Declaration	Data type	Description
CYCLE	INPUT	REAL	SAMPLE TIME OF STEP CONTROLLER [s] <ul style="list-style-type: none"> ■ At this input <code>CYCLE</code>, you enter the sampling time for the controller. ■ Default: 0.0 ■ Range of Values: ≥ 0.001
SP_INT	INPUT	REAL	INTERNAL SETPOINT <ul style="list-style-type: none"> ■ The <code>SP_INT</code> input is used to specify a setpoint. ■ Default: 0.0 ■ Range of Values: Dependent on the sensors used
PV_IN	INPUT	REAL	PROCESS VARIABLE IN <ul style="list-style-type: none"> ■ An initialization value can be set at the <code>PV_PER</code> input or an external process variable in floating-point format can be connected. ■ Default: 0.0 ■ Range of Values: Dependent on the sensors used
PV_PER	INPUT	WORD	PROCESS VARIABLE PERIPHERY <ul style="list-style-type: none"> ■ The process variable in the peripheral I/O format is connected to the controller at the <code>PV_PER</code> input. ■ Default: 0
DISV	INPUT	REAL	DISTURBANCE VARIABLE <ul style="list-style-type: none"> ■ For feed forward control, the disturbance variable is connected to the <code>DISV</code> input. ■ Default: 0.0

Parameter	Declaration	Data type	Description
LMNR_HS	INPUT	BOOL	<p>HIGH LIMIT SIGNAL OF REPEATED MANIPULATED VALUE</p> <ul style="list-style-type: none"> ■ The signal "valve at upper limit stop" is connected to the <i>LMNR_HS</i>. ■ <i>LMNR_HS</i> = TRUE: The valve is at the upper limit stop. ■ Default: FALSE
LMNR_LS	INPUT	BOOL	<p>LOW LIMIT SIGNAL OF REPEATED MANIPULATED VALUE</p> <ul style="list-style-type: none"> ■ The signal "valve at upper lower stop" is connected to the input <i>LMNR_LS</i>. ■ <i>LMNR_LS</i> = TRUE: The valve is at the lower limit stop. ■ Default: FALSE
LMNS_ON	INPUT	BOOL	<p>MANIPULATED SIGNALS ON</p> <ul style="list-style-type: none"> ■ The processing of the controller output signal is set to manual at the <i>LMNS_ON</i> input. ■ Default: TRUE
LMNUP	INPUT	BOOL	<p>MANIPULATED SIGNALS UP</p> <ul style="list-style-type: none"> ■ With the controller output signals set to manual, the <i>QLMNUP</i> output signal is applied to the <i>LMNUP</i> input. ■ Default: FALSE
LMNDN	INPUT	BOOL	<p>MANIPULATED SIGNALS DOWN</p> <ul style="list-style-type: none"> ■ With the controller output signals set to manual, the <i>QLMNDN</i> output signal is applied to the <i>LMNDN</i> input. ■ Default: FALSE
QLMNUP	OUTPUT	BOOL	<p>MANIPULATED SIGNAL UP</p> <ul style="list-style-type: none"> ■ If the <i>QLMNUP</i> output is set, the valve will be opened. ■ Default: FALSE
QLMNDN	OUTPUT	BOOL	<p>MANIPULATED SIGNAL DOWN</p> <ul style="list-style-type: none"> ■ If the <i>QLMNDN</i> output is set, the valve will be closed. ■ Default: FALSE
PV	OUTPUT	REAL	<p>PROCESS VARIABLE</p> <ul style="list-style-type: none"> ■ The effective process variable is output at the <i>PV</i> output. ■ Default: 0.0
PE	OUTPUT	REAL	<p>ERROR SIGNAL</p> <ul style="list-style-type: none"> ■ The effective error is output at the <i>PE</i> output. ■ Default: 0.0
COM_RST	INPUT/ OUTPUT	BOOL	<p>COMPLETE RESTART</p> <ul style="list-style-type: none"> ■ The block has an initialization routine that is processed when the <i>COM_RST</i> input is set. ■ Default: FALSE

Internal Parameters

Parameter	Declaration	Data Type	Description
PV_FAC	INPUT	REAL	<p>PROCESS VARIABLE FACTOR</p> <ul style="list-style-type: none"> ■ The <i>PV_FAC</i> input is multiplied by the "process value". The input is used to adapt the process variable range. ■ Default: 1.0
PV_OFFS	INPUT	REAL	<p>PROCESS VARIABLE OFFSET</p> <ul style="list-style-type: none"> ■ The <i>PV_OFFS</i> input is added to the process variable. The input is used to adapt the process variable range. ■ Default: 0.0 ■ Range of Values: Dependent on the sensors used
DEADB_W	INPUT	REAL	<p>DEAD BAND WIDTH</p> <ul style="list-style-type: none"> ■ The error passes through a dead band. The <i>DEADB_W</i> input decides the size of the dead band. ■ Default: 0.0 ■ Range of Values: Dependent on the sensors used
PFAC_SP	INPUT	REAL	<p>PROPORTIONAL FACTOR FOR SETPOINT CHANGES [0..1]</p> <ul style="list-style-type: none"> ■ <i>PFAC_SP</i> specifies the effective P action when there is a setpoint change. This is set between 0 and 1. <ul style="list-style-type: none"> – 1: P action has full effect if the setpoint changes. – 0: P action has no effect if the setpoint changes. ■ Default: 1.0 ■ Range of Values: 0.0 ... 1.0
GAIN	INPUT	REAL	<p>PROPORTIONAL GAIN</p> <ul style="list-style-type: none"> ■ The <i>GAIN</i> input specifies the controller gain. The direction of control can be reversed by giving <i>GAIN</i> a negative sign. ■ Default: 2.0 ■ Range of Values: %/phys. unit
TI	INPUT	REAL	<p>RESET TIME [s]</p> <ul style="list-style-type: none"> ■ The <i>TI</i> input (integral time) decides the integral action response. ■ Default: 40.0 s ■ Range of Values: ≥ 0.0 s
MTR_TM	INPUT	REAL	<p>MOTOR ACTUATING TIME</p> <ul style="list-style-type: none"> ■ The operating time of the valve from limit stop to limit stop is entered in the <i>MTR_TM</i> parameter. ■ Default: 30 s ■ Range of Values: \geq <i>CYCLE</i>

Parameter	Declaration	Data Type	Description
PULSE_TM	INPUT	REAL	MINIMUM PULSE TIME <ul style="list-style-type: none"> ■ A minimum pulse time can be set with the <i>PULSE_TM</i> parameter. ■ Default: 0.1s ■ Range of Values: ≥ 0.0 s
BREAK_TM	INPUT	REAL	MINIMUM BREAK TIME <ul style="list-style-type: none"> ■ A minimum break time can be set with the <i>BREAK_TM</i> parameter. ■ 0.1s ■ Range of Values: ≥ 0.0 s
PER_MODE	INPUT	INT	PERIPHERIE MODE <ul style="list-style-type: none"> ■ You can enter the type of the I/O module at this switch. The process variable at input <i>PV_PER</i> is then normalized to °C at the <i>PV</i> output. <ul style="list-style-type: none"> – <i>PER_MODE</i> = 0: standard – <i>PER_MODE</i> = 1: climate – <i>PER_MODE</i> = 2: current/voltage ■ Default: 0 ■ Range of Values: 0, 1, 2
PVPER_ON	INPUT	BOOL	PROCESS VARIABLE PERIPHERY ON <ul style="list-style-type: none"> ■ If you want the process variable to be read in from the I/O, the <i>PV_PER</i> input must be connected to the I/O and the <i>PVPER_ON</i> input must be set. ■ Default: FALSE

Application

- The functionality is based on the PI control algorithm of the sampling controller. This is supplemented by the functions for generating the binary output signal from the analog actuating signal.
- You can also use the controller in a cascade control as a secondary position controller. You specify the actuator position via the setpoint input *SP_INT*. In this case, you must set the process value input and the parameter *TI* (integral time) to zero. An application might be, for example, temperature control with heating power control using pulse-break activation and cooling control using a butterfly valve. To close the valve completely, the manipulated variable ($ER * GAIN$) should be negative.
- Apart from the functions in the process variable branch, FB 59 TCONT_S implements a complete PI controller with binary manipulated value output and the option of influencing the controller output signals manually. The step controller operates without a position feedback signal.



The values in the controller blocks are only calculated correctly if the block is called at regular intervals. Therefore, you have to call the controller blocks in a cyclic interrupt OB (OB 30 ... 38) at regular intervals. The sampling time is predefined on the parameter CYCLE.

Forming the Error

Block Diagram

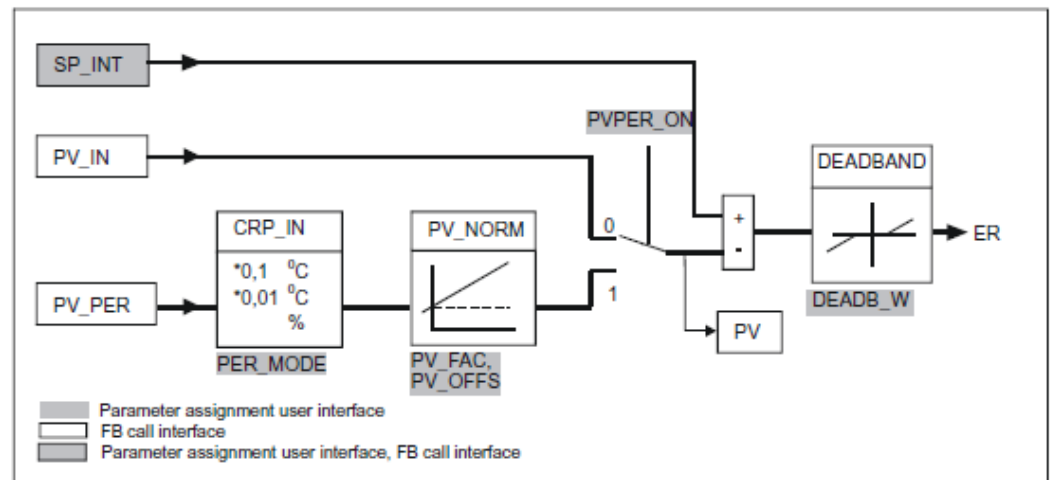

Setpoint Branch

The setpoint is entered at input *SP_INT* in floating-point format as a physical value or percentage. The setpoint and process value used to form the error must have the same unit.

Process Value Options (*PVPER_ON*)

Depending on *PVPER_ON*, the process value can be acquired in the peripheral (I/O) or floating-point format.

<i>PVPER_ON</i>	Process Value Input
TRUE	The process value is read in via the analog peripheral I/Os (PIW xxx) at input <i>PV_PER</i> .
FALSE	The process value is acquired in floating-point format at input <i>PV_IN</i> .

Process Value Format Conversion *CRP_IN* (*PER_MODE*)

The *CRP_IN* function converts the peripheral value *PV_PER* to a floating-point format depending on the switch *PER_MODE* according to the following rules:

<i>PER_MODE</i>	Output of <i>CRP_IN</i>	Analog Input Type	Unit
0	$PV_PER * 0.1$	Thermoelements; PT100/NI100; standard	°C; °F
1	$PV_PER * 0.01$	PT100/NI100; climate	°C; °F
2	$PV_PER * 100/27648$	Voltage/current	%

Process Value Normalization *PV_NORM* (*PV_FAC*, *PV_OFFS*)

The *PV_NORM* function calculates the output of *CRP_IN* according to the following rule:
 $Output\ of\ PV_NORM = Output\ of\ CPR_IN * PV_FAC + PV_OFFS$

This can be used for the following purposes:

- Process value correction with PV_FAC as the process value factor and PV_OFFS as the process value offset.
- Normalization of temperature to percentage
You want to enter the setpoint as a percentage and must now convert the measured temperature value to a percentage.
- Normalization of percentage to temperature
You want to enter the setpoint in the physical temperature unit and must now convert the measured voltage/current value to a temperature.

Calculation of the parameters:

- $PV_FAC = \text{range of } PV_NORM / \text{range of } CRP_IN$
- $PV_OFFS = LL(PV_NORM) - PV_FAC * LL(CRP_IN)$; where LL is the lower limit

With the default values ($PV_FAC = 1.0$ and $PV_OFFS = 0.0$), normalization is disabled. The effective process value is output at the PV output.

Example of Process Variable Normalization

If you want to enter the setpoint as a percentage, and you have a temperature range of -20 to 85 °C applied to CRP_IN , you must normalize the temperature range as a percentage. The schematic below shows the adaptation of the temperature range from -20 ... 85°C to an internal scale of 0 ... 100 %:

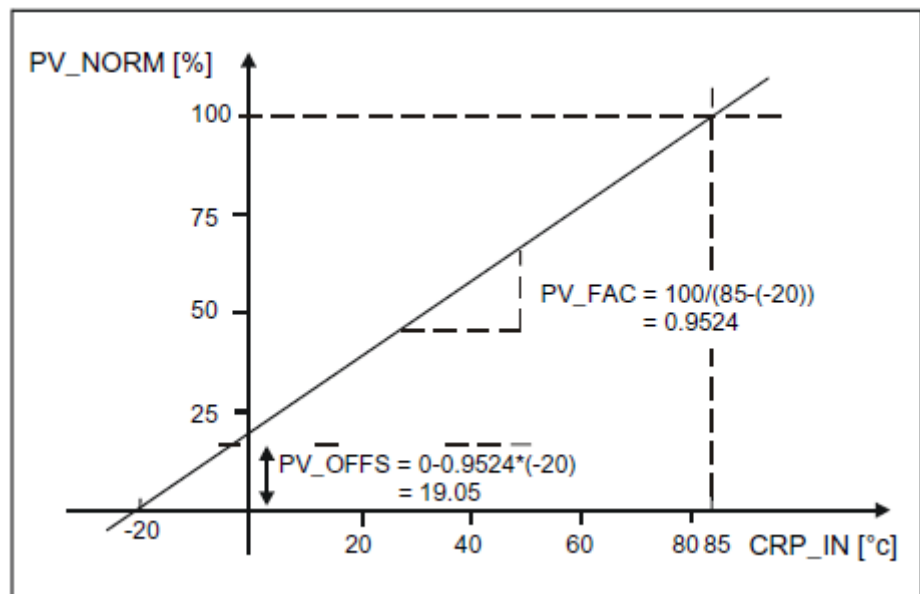

Forming the Error

The difference between the setpoint and process value is the error before the deadband. The setpoint and process value must exist in the same unit.

Deadband ($DEADB_W$)

To suppress a small constant oscillation due to the manipulated variable quantization (for example in pulse duration modulation with PULSEGEN) a deadband ($DEADBAND$) is applied to the error. If $DEADB_W = 0.0$, the deadband is deactivated.

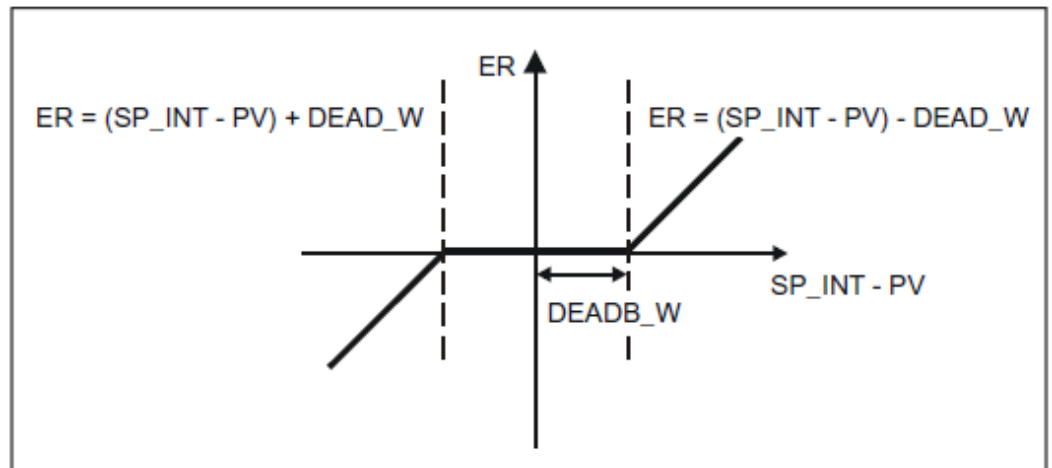

PI Step Controller Algorithm

FB 59 TCONT_S works without a position feedback signal (see following block diagram). The I-action of the PI algorithm and the assumed position feedback signal are calculated in an integrator (INT) and compared as a feedback value with the remaining P-action. The difference is applied to a three-step element (THREE_ST) and a pulse generator (PULSEOUT) that forms the pulses for the valve. Adapting the response threshold of the three-step element reduces the switching frequency of the controller.

Weakening the P-Action when Setpoint Changes Occur

To prevent overshoot, you can weaken the P-action using the "proportional factor for setpoint changes" parameter ($PFAC_SP$). Using $PFAC_SP$, you can now select continuously between 0.0 and 1.0 to decide the effect of the P-action when the setpoint changes:

- $PFAC_SP = 1.0$: P-action has full effect if the setpoint changes
- $PFAC_SP = 0.0$: P-action has no effect if the setpoint changes

A value for $PFAC_SP < 1.0$ can reduce the overshoot as with the continuous controller if the motor run time MTR_TM is small compared with the recovery time TA and the ratio TU/TA is < 0.2 . If MTR_TM reaches 20 % of TA , only a slight improvement can be achieved.

Feedforward Control

A load can be added at the $DISV$ input.

Manual Value Processing ($LMNS_ON$)

With $LMNS_ON$, you can change between manual and automatic mode. In manual mode, the actuator and the integrator (INT) are set to 0 internally. Using $LMNUP$ and $LMNDN$, the actuator can be adjusted to OPEN and CLOSED. Switching over to automatic mode therefore involves a bump. As a result of the $GAIN$, the existing error leads to a step change in the internal manipulated variable. The integral component of the actuator, however, results in a ramp-shaped excitation of the process.

Block Diagram

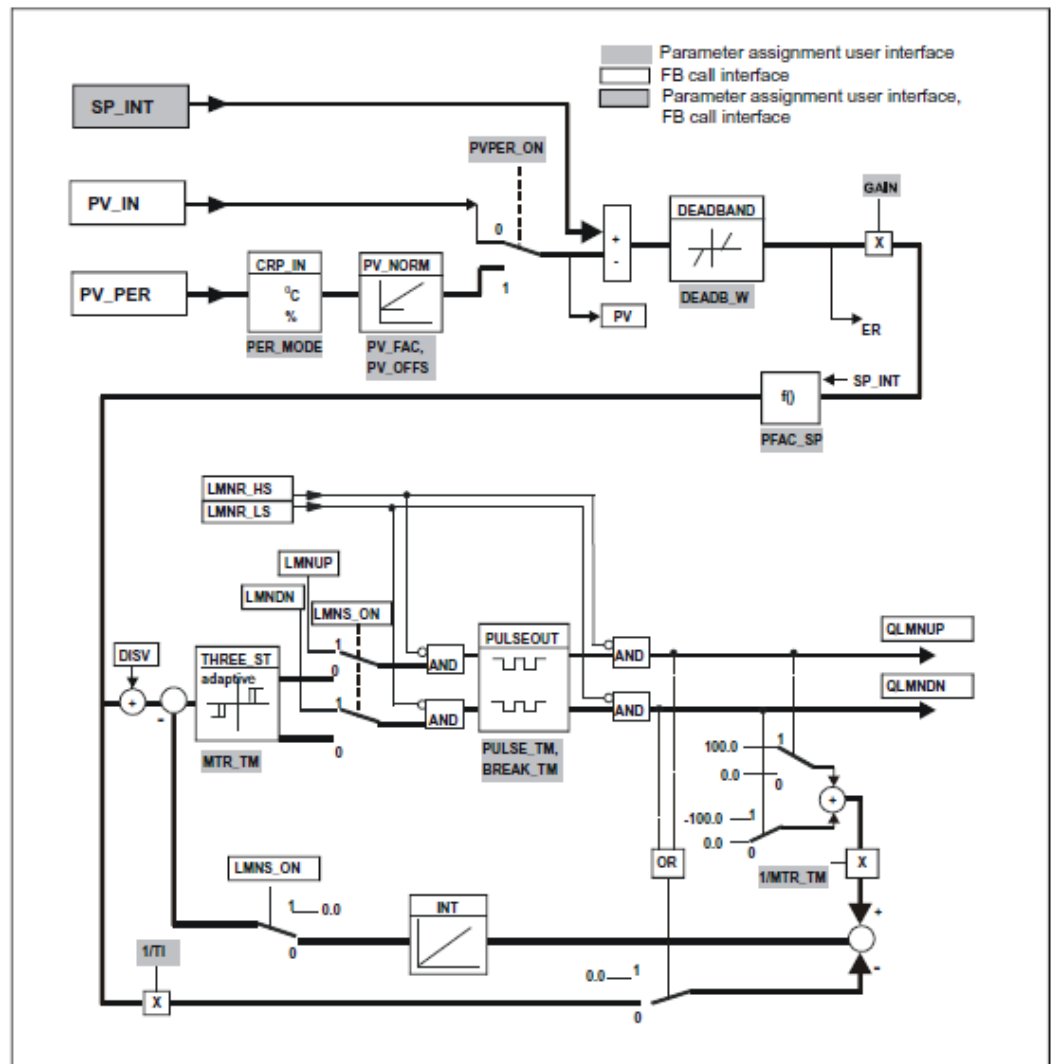

15.6 Time Functions

15.6.1 UDT 60 - WS_RULES - Rule DB

Description

Your system must provide certain information in a DB that is evaluated by the various blocks. You create this data block as a DB of the type UDT60 and enter the values that apply to your location (in local time!).

Calculation of base time < - > local time and "set alarm acc. to local time"

Name	Type	Start value	Comment
B2L	STRUCT		Base time < - > Local time
S	INT	2	Offset base time -> local time [30 min] in winter permitted: -24 .. +24.
T	INT	3	Difference summer to winter time [30 min] permitted: 2

Rule for: standard -> daylight-saving time. Default: Last Sunday in March; 2:00 o'clock

Name	Type	Start value	Comment
W2S	STRUCT		W2S must be specified in STANDARD TIME!
M	BYTE	B#16#3	Month of switchover
W	BYTE	B#16#9	nth occurrence of the weekday (1 = first, 2 = second, . . . , 9 = last)
D	BYTE	B#16#1	Day of week (Sunday = 1)
H	BYTE	B#16#2	Hour

Rule for: daylight-saving -> standard time. Default: Last Sunday in October 3:00 o'clock

Name	Type	Start value	Comment
S2W	STRUCT		S2W must be specified in DAYLIGHT-SAVING TIME
M	BYTE	B#16#10	Month of switchover
W	BYTE	B#16#9	nth occurrence of the weekday (1 = first, 2 = second, . . . , 9 = last)
D	BYTE	B#16#1	Day of week (Sunday = 1)
H	BYTE	B#16#3	Hour



All the parameters that have the format BYTE are interpreted as BCD values!



The specification of the daylight-saving/standard time switchover points by a rule is mandatory in the EU as of 2002.

15.6.2 FC 61 - BT_LT - Convert base timer to local time

Description

The FC 61 calculates the local time for the base time specified at the input.

Parameter

Parameter	Declaration	Data type	Description
BT	INPUT	DATE_AND_TIME	Base time
WS_DAT	INPUT	BLOCK_DB	Information on the time zone for standard/daylight saving switchover (Rule DB)
RET_VAL	OUTPUT	INT	Error code
LT	OUTPUT	DATE_AND_TIME	Local time

How It Works

The base time entered at input *BT* is converted to the local time using the data stored in a DB and applied to output *LT*. The DB contains the number of 30-minute units by which the base time and local time differ and the difference between daylight-saving time and standard time also in units of 30 minutes. (Rule DB) If the calculation results in a date overflow, this is indicated by a special return value.

Calling OBs

FC 61 BT_LT can be called in any priority class.

Call Environment

Internally, FC 61 uses the following functions. These functions must be loaded in your project with the numbers shown here. FC1 (AD_DT_TM), FC7 (DT_DAY), FC35 (SB_DT_TM)

Output Values / Errors

RET_VAL	LT	Description
0	Local time	Block executed error-free
1	Local time	No error, but date jump
8082	DT#90-01-01-0:0:0	Invalid data in the rule data block

15.6.3 FC 62 - LT_BT - Convert local time to base time**Description**

The FC 62 calculates the base time for the local time specified at the input.

Parameters

Parameter	Deklaration	Datentyp	Beschreibung
LT	INPUT	DATE_AND_TIME	Local time
WS_DAT	INPUT	BLOCK_DB	Information on the time zone for standard/daylight saving switchover (Rule DB)
RET_VAL	OUTPUT	INT	Error code
LT	OUTPUT	DATE_AND_TIME	Base time

How It Works

The local time entered at input *LT* is converted to the base time using the data stored in a DB and applied to output *BT*. The DB contains the number of 30-minute units by which the base time and local time differ and the difference between daylight-saving time and standard time also in units of 30 minutes. (Rule DB) If the calculation results in a date overflow, this is indicated by a special return value.

"Forbidden Hour"

During the switchover from standard to daylight-saving time the local time is put forward one hour. This, however, means that the hour in between is not run through. If there is an *LT* (local time) within this hour, FC62 LT_BT "thinks" in daylight-saving time. This is reported with return value 4 or 5.

"Double Hour"

During the switchover from daylight-saving to standard time the local time is put back one hour. This, however, means that one hour is run through twice. (For CE(S)T the designators 2A and 2B apply). For an *LT* (local time) within this hour, no unique identification relative to a base time is possible. FC LT_BT receives an *LT* as an input parameter and must decide whether the time is standard or daylight-saving before converting it to BT. If the *LT* is within the double hour, the *LT* is interpreted as standard time. This is reported with return value 2 or 3.

Calling OBs

FC 62 LT_BT can be called in any priority class.

Call Environment

Internally, FC 62 uses the following functions. These functions must be loaded in your project with the numbers shown here. FC1 (AD_DT_TM), FC7 (DT_DAY), FC35 (SB_DT_TM)

Output Values / Errors

RET_VAL	LT	Description
0	Base time	Block executed error-free
1	Base time	No error, but date jump
2	Base time	The LT at the input is within the "double" hour
3	Base time	As 2, also date jump
4	Base time	The LT at the input is within the "forbidden" hour
5	Base time	As 4, also date jump
8082	DT#90-01-01-0:0:0	Invalid data in the rule data block

15.6.4 FC 63 - S_LTINT - Set time interrupt in local time**Description**

The FC sets the required time-of-day interrupt at the set time. This time is output in local time.

Parameters

Parameter	Declaration	Data type	Description
OB_NR	INPUT	INT	No of the OB to be started (permitted 10 – 17)
SDT	INPUT	BLOCK_DB	Start date and time-of-day in local time (see SFC28)
PERIOD	INPUT	INT	Period from start point SDT: <ul style="list-style-type: none"> ■ W#16#0000 = once ■ W#16#0201 = every minute ■ W#16#0401 = every hour ■ W#16#1001 = daily ■ W#16#1201 = weekly ■ W#16#1401 = monthly ■ W#16#1801 = annually ■ W#16#2001 = at end of month

Parameter	Declaration	Data type	Description
WS_DAT	INPUT	DATE_AND_TIME	Information on the time zone for standard/daylight saving switchover (see above)
RET_VAL	OUTPUT	INT	Error code

How It Works

The local time entered at input *LT* is converted to the base time using the rule stored in a DB. The DB contains the number of 30-minute units by which the base time and local time differ and the difference between daylight-saving time and standard time also in units of 30 minutes (see above). The specified time-of-day interrupt OB is assigned parameter values and activated using the calculated base time. If the calculation results in a date overflow, this is indicated by a special return value.

"Forbidden Hour"

During the switchover from standard to daylight-saving time the local time is put forward one hour. This, however, means that the hour in between is not run through. If there is an *LT* (local time) within this hour, FC S_LTINT "thinks" in daylight-saving time. This is reported with return value 4 or 5.

"Double Hour"

During the switchover from daylight-saving to standard time the local time is put back one hour. This, however, means that one hour run through twice. (For CE(S)T the designators 2A and 2B apply). For an *LT* (local time) within this hour, no unique identification relative to a base time is possible. FC S_LTINT receives an *LT* as input parameter and must decide whether the time is standard or daylight-saving before converting it to *BT*. If the *LT* is within the double hour, the *LT* is interpreted as standard time. This is reported with return value 2 or 3.

Calling OBs

FC S_LTINT can be called in any priority class. Internally, FC S_LTINT uses the following functions. These functions must be loaded in your project with the numbers shown here. FC7 (DT_DAY), FC35 (SB_DT_TM)

Output Values / Errors

RET_VAL	Description
0	Block executed error-free
1	No error, but date jump
2	The LT at the input was within the "double" hour
3	As 2, also date jump
4	The LT at the input is within the "forbidden" hour
5	As 4, also date jump
8082	Invalid data in the rule data block
8090	Bad OB_NR parameter
8091	Bad SDT parameter
8092	Bad PERIOD parameter
80A1	The set start time is in the past
80A2	OB is not loaded
80A3	OB cannot be started

16 System Blocks

Block library "System Blocks"

The block library can be found for download in the 'Service/Support' area of www.vipa.com at 'Downloads → VIPA Lib' as 'Block library System Blocks - SW90KS0MA'. The library is available as packed zip file. As soon as you want to use these blocks you have to import them into your project. ↪ [Chap. 5 'Include VIPA library' page 69](#)

16.1 Fetch/Write Communication

16.1.1 SFC 228 - RW_KACHEL - Page frame direct access

Description

This SFC allows you the direct access to the page frame area of the CPU with a size of 4kbyte. The page frame area is divided into four page frames, each with a size of 1kbyte. Setting the parameters page frame number, -offset and data width, the SFC 228 enables read and write access to an eligible page frame area.



This SFC has been developed for test purposes and for building-up proprietary communication systems and is completely at the user's disposal. Please regard that a write access to the page frame area influences a communication directly!

Parameters

Name	Declaration	Type	Description
K_NR	IN	INT	Page frame number
OFFSET	IN	INT	Page frame offset
R_W	IN	INT	Access
SIZE	IN	INT	Data width
RET_VAL	OUT	BYTE	Return value (0 = OK)
VALUE	IN_OUT	ANY	Pointer to area of data transfer

K_NR

Page frame number

- Type the page frame no. that you want to access.
 - Value range: 0 ... 3

OFFSET

Page frame offset

- Fix here an offset within the specified page frame.
 - Value range: 0 ... 1023

R_W

Read/Write

- This parameter specifies a read res. write access.
 - 0 = read access
 - 1 = write access

- SIZE** Size
- The size defines the width of the data area fixed via *K_NR* and *OFFSET*. You may choose between the values 1, 2 and 4byte.
- RET_VAL (Return Value)** Byte where an error message is returned to.
- VALUE** In-/output area
- This parameter fixes the in- res. output area for the data transfer.
 - At a read access, this area up to 4byte width contains the data read from the page frame area.
 - At a write access, the data up to 4byte width is transferred to the page frame area.
 - Parameter type: Pointer

Example The following example shows the read access to 4byte starting with byte 712 in page frame 2. The read 4byte are stored in DB10 starting with byte 2. For this the following call is required:

```
CALL SFC 228
K_NR      :=2
OFFSET   :=712
R_W      :=0
SIZE     :=4
RET_VAL  :=MB10
VALUE    :=P#DB10.DBX 2.0 Byte 4
```

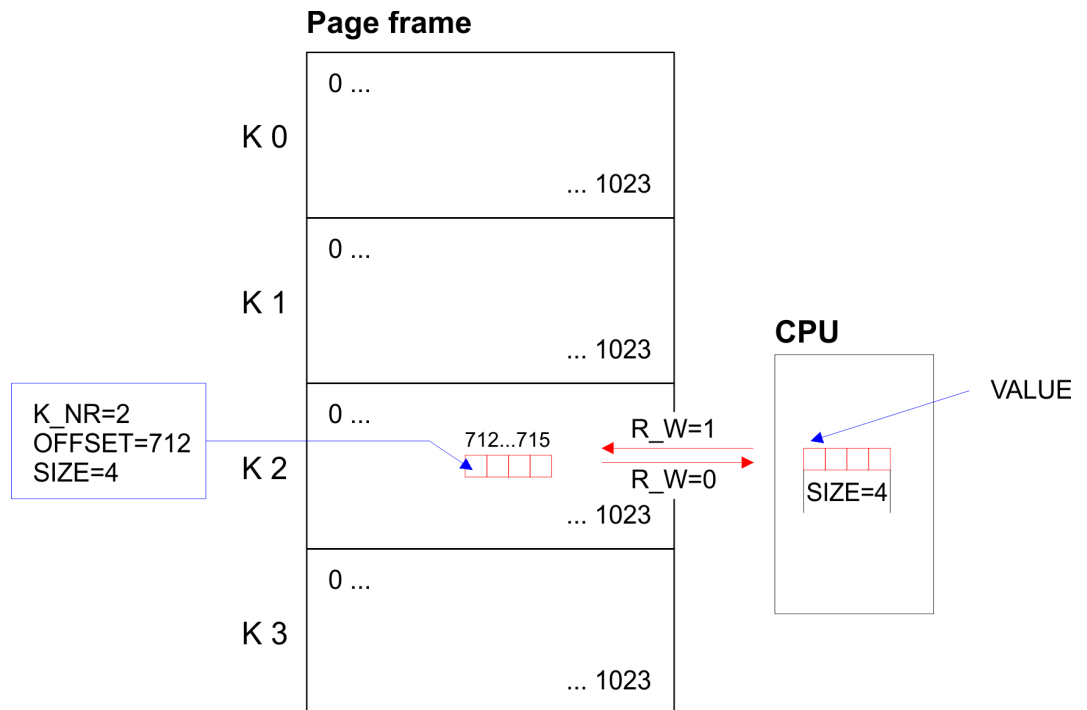

Error messages

Value	Description
00h	no error
01h ... 05h	Internal error: No valid address found for a parameter

Value	Description
06h	defined page frame does not exist
07h	parameter SIZE \neq 1, 2 or 4 at read access
08h	parameter SIZE \neq 1, 2 or 4 at write access
09h	parameter R_W is \neq 0 or 1

16.1.2 SFC 230 ... 238 - Page frame communication

16.1.2.1 Parameter description

Overview

The handling blocks allow the deployment of communication processors in the CPUs from VIPA. The handling blocks control the complete data transfer between CPU and the CPs. Advantages of the handling blocks:

- you lose only few memory space for user application
- short runtimes of the blocks

The handling blocks don't need:

- bit memory area
- time areas
- counter areas

All handling blocks described in the following use an identical interface to the user application with these parameters:

<i>SSNR</i>	- Interface number
<i>ANR</i>	- Order number
<i>ANZW</i>	- Indicator word (double word)
<i>IND</i>	- Indirect fixing of the relative start address of the data source res. destination
<i>QANF/ZANF</i>	- Relative start address within the type
<i>PAFE</i>	- Parameterization error
<i>BLGR</i>	- Block size

SSNR

Interface number

- Number of the logical interface (page frame address) to which the according order refers to.
 - Parameter type: Integer
 - Convenient range: 0 ... 255

ANR

Job number

- The called job number for the logical interface.
 - Parameter type: Integer
 - Convenient range: 1 ... 223

ANZW

Indicator word (double word)

- Address of the indicator double word in the user memory where the processing of the order specified under ANR is shown.
 - Parameter type: Double word
 - Convenient range: DW or MW; use either DW and DW+1 or MW and MW+2
The value DW refers to the data block opened before the incoming call or to the directly specified DB.

IND

Kind of parameterization (direct, indirect)

- This parameter defines the kind of data on which the pointer *QANF* points.
 - 0: *QANF* points directly to the initial data of the source res. destination data.
 - 1: the pointer *QANF/ZANF* points to a memory cell, from where on the source res. destination data are defined (indirect).
 - 2: the pointer *QANF/ZANF* points to a memory area where the source res. destination information lies (indirect).
 - 5: the pointer *QANF/ZANF* points to a memory cell, from where on the source res. destination data and parameters of the indicator word are defined (indirect).
 - 6: the pointer *QANF/ZANF* points to a memory area where the source res. destination data and parameters of the indicator word are laying (indirect).
 - Parameter type: Integer
 - Convenient entries: 0, 1, 2, 5, 6



Please regard, that at IND = 5 res. IND = 6, the parameter ANZW is ignored!

QANF/ZANFRelative start address of the data source res. destination and at *IND* = 5 res. *IND* = 6 of the indicator word.

- This parameter of the type "pointer" (Any-Pointer) allows you fix the relative starting address and the type of the data source (at SEND) res. the data destination (at RECEIVE).
- At *IND* = 5 res. *IND* = 6 the parameters of the indicator word are also in the data source.
 - Parameter type: Pointer
 - Convenient range: DB, M, A, E

Example:

```
P#DB10.DBX0.0 BYTE 16
P#M0.0 BYTE 10
P#E 0.0 BYTE 8
P#A 0.0 BYTE 10
```

BLGR

Block size

- During the boot process the stations agree about the block size (size of the data blocks) by means of SYNCHRON.
- A high block size = high data throughput but longer run-times and higher cycle load.
- A small block size = lower data throughput but shorter run-times of the blocks.

These block sizes are available:

Value	Block size	Value	Block size
0	Default (64byte)	4	128byte
1	16byte	5	256byte
2	32byte	6	512byte
3	64byte	255	512byte

- Parameter type: Integer
- Convenient range: 0 ... 255

PAFE

Error indication at parameterization defects

- This "BYTE" (output, marker) is set if the block detects a parameterization error, e.g. interface (plug-in) not detected or a non-valid parameterization of QUANF/ZANF.
 - Parameter type: Byte
 - Convenient range: AB 0 ... AB127, MB 0...MB 255

16.1.2.2 Parameter transfer**Direct/indirect parameterization**

A handling block may be parameterized directly or indirectly. Only the "PAFE" parameter must always been set directly. When using the direct parameterization, the handling block works off the parameters given immediately with the block call. When using the indirect parameterization, the handling block gets only pointers per block parameters. These are pointing to other parameter fields (data blocks or data words). The parameters *SSNR*, *ANR*, *IND* and *BLGR* are of the type "integer", so you may parameterize them indirectly.

Example**Direct parameter transfer**

```
CALL SFC 230
      SSNR:=0
      ANR :=3
      IND :=0
      QUANF:=P#A 0.0 BYTE 16
      PAFE:=MB79
      ANZW:=MD44
```

Indirect parameter transfer

```
CALL SFC 230
      SSNR:=MW10
      ANR :=MW12
      IND :=MW14
      QUANF:=P#DB10.DBX0.0 BYTE 16
      PAFE:=MB80
      ANZW:=MD48
```

Please note that you have to load the bit memory words with the corresponding values before.

16.1.2.3 Source res. destination definition**Overview**

You have the possibility to set the entries for source, destination and *ANZW* directly or store it indirectly in a block to which the *QUANF / ZANF* res. *ANZW* pointer points. The parameter *IND* is the switch criterion between direct and indirect parameterization.

Direct parameterization of source and destination details (IND = 0)

With *IND* = 0 you fix that the pointer *QANF* / *ZANF* shows directly to the source res. destination data. The following table shows the possible *QANF* / *ZANF* parameters at the direct parameterization:

QTYP/ZTYP	Data in DB	Data in MB	Data in OB Process image of the outputs	Data in IB Process image of the inputs
Pointer: Example:	P#DBa.DBX b.0 BYTE CP#DB10.DBX 0.0 BYTE 8	P#M b.0 BYTE cP#M 5.0 BYTE 10	P#A b.0 BYTE cP#A 0.0 BYTE 2	P#E b.0 BYTE cP#E 20.0 BYTE 1
DB, MB, AB, EB Definition	P#DBa "a" means the DB-No., from where the source data is fetched or where to the destination data is transferred.	P#M The data is stored in a MB.	P#A The data is stored in the output byte.	P#E The data is stored in the input byte.
Valid range for "a"	0 ... 32767	irrelevant	irrelevant	irrelevant
Data / Marker Byte, OB, IB Definition	DB-No., where data fetch or write starts.	Bit memory byte number, where data fetch or write starts.	Output byte number, where data fetch or write starts.	Input byte number, where data fetch or write starts.
Valid range for "b"	0.0 ... 2047.0	0 ... 255	0 ... 127	0 ... 127
BYTE c Valid range for "c"	Length of the Source/ Destination data blocks in words. 1 ... 2048	Length of the Source/ Destination data blocks in bytes. 1 ... 255	Length of the Source/ Destination data blocks in bytes. 1 ... 128	Length of the Source/ Destination data blocks in bytes. 1 ... 128

Indirect parameterization of source and destination details (IND = 1 or IND = 2)

Indirect addressing means that *QANF* / *ZANF* points to a memory area where the addresses of the source res. destination areas and the indicator word are stored. In this context you may either define one area for data source, destination and indicator word (*IND* = 1) or each, data source, data destination and the indicator word, get an area of their own (*IND* = 2). The following table shows the possible *QANF* / *ZANF* parameters for indirect parameterization:

QTYP/ZTYP	IND = 1	IND = 2
Definition	Indirect addressing for source or destination parameters. The source or destination parameters are stored in a DB. <i>QANF/ZANF</i> :	Indirect addressing for source and destination parameters. The source and destination parameters are stored in a DB in a sequential order. <i>QANF/ZANF</i> :
	DW +0 Data type source	DW +0 Data type source
	+2 DB-Nr. at type "DB", otherwise irrelevant	+2 DB-Nr. at type "DB", otherwise irrelevant
	+4 Start address	+4 Start address
	+6 Length in Byte	+6 Length in Byte
		+8 Data type destination
		+10 DB-Nr. at type "DB", otherwise irrelevant
		+12 Start address
		+14 Length in Byte
valid DB-No.	0 ... 32767	0 ... 32767

QTYP/ZTYP	IND = 1	IND = 2
Data word Definition	DW-No., where the stored data starts	DW-No., where the stored data starts
Valid range	0.0 ... 2047.0	0.0 ... 2047.0
Length Definition	Length of the DBs in byte	Length of the DBs in byte
Valid range	8 fix	16 fix

Indirect parameterization of source and destination details and ANZW (IND = 5 or IND = 6)

Indirect addressing means that *QANF / ZANF* points to a memory area where the addresses of the source res. destination areas and the indicator word are stored. In this context you may either define one area for data source, destination and indicator word (*IND = 5*) or each, data source, data destination and the indicator word, get an area of their own (*IND = 6*). The following table shows the possible *QANF / ZANF* parameters for indirect parameterization:

QTYP/ZTYP	IND = 5	IND = 6																																												
Definition	Indirect addressing for source or destination parameters and indicator word (<i>ANZW</i>). The source or destination parameters and <i>ANZW</i> are stored in a DB in a sequential order. <i>QANF/ZANF</i>	Indirect addressing for source and destination parameters and indicator word (<i>ANZW</i>). The source and destination parameters and <i>ANZW</i> are stored in a DB in a sequential order. <i>QANF/ZANF</i>																																												
	<table border="1"> <thead> <tr> <th>DW +0</th> <th>Data type source</th> <th>Description data source/ destination</th> </tr> </thead> <tbody> <tr> <td>+2</td> <td>DB-Nr. at type "DB", otherwise irrelevant</td> <td rowspan="3"></td> </tr> <tr> <td>+4</td> <td>Start address</td> </tr> <tr> <td>+6</td> <td>Length in Byte</td> </tr> <tr> <td>+8</td> <td>Data type destination</td> <td rowspan="3">Description indicator word</td> </tr> <tr> <td>+10</td> <td>DB-Nr. at type "DB", otherwise irrelevant</td> </tr> <tr> <td>+12</td> <td>Start address</td> </tr> </tbody> </table>	DW +0	Data type source	Description data source/ destination	+2	DB-Nr. at type "DB", otherwise irrelevant		+4	Start address	+6	Length in Byte	+8	Data type destination	Description indicator word	+10	DB-Nr. at type "DB", otherwise irrelevant	+12	Start address	<table border="1"> <thead> <tr> <th>DW +0</th> <th>Data type source</th> <th>Description data source</th> </tr> </thead> <tbody> <tr> <td>+2</td> <td>DB-Nr. at type "DB", otherwise irrelevant</td> <td rowspan="3"></td> </tr> <tr> <td>+4</td> <td>Start address</td> </tr> <tr> <td>+6</td> <td>Length in Byte</td> </tr> <tr> <td>+8</td> <td>Data type destination</td> <td rowspan="3">Description data destination</td> </tr> <tr> <td>+10</td> <td>DB-Nr. at type "DB", otherwise irrelevant</td> </tr> <tr> <td>+12</td> <td>Start address</td> </tr> <tr> <td>+14</td> <td>Length in Byte</td> <td rowspan="3">Description indicator word</td> </tr> <tr> <td>+16</td> <td>Data type source</td> </tr> <tr> <td>+18</td> <td>DB-Nr. at type "DB", otherwise irrelevant</td> </tr> <tr> <td>+20</td> <td>Start address</td> <td></td> </tr> </tbody> </table>	DW +0	Data type source	Description data source	+2	DB-Nr. at type "DB", otherwise irrelevant		+4	Start address	+6	Length in Byte	+8	Data type destination	Description data destination	+10	DB-Nr. at type "DB", otherwise irrelevant	+12	Start address	+14	Length in Byte	Description indicator word	+16	Data type source	+18	DB-Nr. at type "DB", otherwise irrelevant	+20	Start address	
DW +0	Data type source	Description data source/ destination																																												
+2	DB-Nr. at type "DB", otherwise irrelevant																																													
+4	Start address																																													
+6	Length in Byte																																													
+8	Data type destination	Description indicator word																																												
+10	DB-Nr. at type "DB", otherwise irrelevant																																													
+12	Start address																																													
DW +0	Data type source	Description data source																																												
+2	DB-Nr. at type "DB", otherwise irrelevant																																													
+4	Start address																																													
+6	Length in Byte																																													
+8	Data type destination	Description data destination																																												
+10	DB-Nr. at type "DB", otherwise irrelevant																																													
+12	Start address																																													
+14	Length in Byte	Description indicator word																																												
+16	Data type source																																													
+18	DB-Nr. at type "DB", otherwise irrelevant																																													
+20	Start address																																													
valid DB-No.	0 ... 32767	0 ... 32767																																												
Data word Definition	DW-Nr., where the stored data starts	DW-Nr., where the stored data starts																																												
Valid range	0.0 ... 2047.0	0.0 ... 2047.0																																												
Length Definition	Length of the DBs in byte	Length of the DBs in byte																																												
Valid range	14 fix	22 fix																																												

16.1.2.4 Indicator word ANZW

Status and error reports

Status and error reports are created by the handling blocks:

- by the indicator word *ANZW* (information at order commissioning).
- by the parameter error byte *PAFE* (indication of a wrong order parameterization).

Content and structure of the indicator word ANZW

The "Indicator word" shows the status of a certain order on a CP. In your PLC program you should keep one indicator word for each defined order at hand. The indicator word has the following structure:

Byte	Bit 7 ... Bit 0
0	<ul style="list-style-type: none"> ■ Bit 3 ... Bit 0: Error management CPU <ul style="list-style-type: none"> – 0: no error – 1 ... 5: CPU-Error – 6 ... 15: CP-Error ■ Bit 7 ... Bit 4: reserved
1	<p>State management CPU</p> <ul style="list-style-type: none"> ■ Bit 0: Handshake convenient (data exists) <ul style="list-style-type: none"> – 0: RECEIVE blocked – 1: RECEIVE released ■ Bit 1: order commissioning is running <ul style="list-style-type: none"> – 0: SEND/FETCH released – 1: SEND/FETCH blocked ■ Bit 2: Order ready without errors ■ Bit 3: Order ready with errors <p>Data management handling block</p> <ul style="list-style-type: none"> ■ Bit 4: Data receive/send is running ■ Bit 5: Data transmission active ■ Bit 6: Data fetch active ■ Bit 7: Disable/Enable data block <ul style="list-style-type: none"> – 1: released – 0: blocked
2 ... 3	Length word handling block

In the "length word" the handling blocks (SEND, RECEIVE) store the data that has already been transferred, i.e. received data in case of a Receive order, send data when there is a Send order. The announcement in the "length word" is always in byte and absolute.

Error management Byte 0, Bit 0 ... Bit 3

Those bits announce the error messages of the order. The error messages are only valid if the bit "Order ready with error" in the status bit is set simultaneously.

The following error messages may occur:

- 0 - **no error**

If the bit "Order ready with error" is set, the CP had to reinitialize the connection, e.g. after a reboot or RESET.
- 1 - **wrong Q/ZTYP at HTB**

The order has been parameterized with the wrong type label.
- 2 - **AG area not found**

The order impulse had a wrong parameterized DB-No.
- 3 - **AG area too small**

Q/ZANF and Q/ZLAE overwrite the range boundaries. Handling with data blocks the range boundary is defined by the block size. With flags, timers, counters etc. the range size depends on the AG.
- 4 - **QVZ-Error in the AG**

This error message means, that you chose a source res. destination parameter of the AG area, where there is either no block plugged in or the memory has a defect. The QVZ error message can only occur with the type Q/ZTYP AS, PB, QB or memory defects.
- 5 - **Error at indicator word**

The parameterized indicator word cannot be handled. This error occurs, if ANZW declared a data word res. double word, that is not (any more) in the specified data block, i.e. DB is too small or doesn't exist.
- 6 - **no valid ORG-Format**

The data destination res. source isn't declared, neither at the handling block (Q/TYP="NN") nor at the coupler block.
- 7 - **Reserved**
- 8 - **no available transfer connections**

The capacity for transfer connections is at limit. Delete unnecessary connections.
- 9 - **Remote error**

There was an error at the communication partner during a READ/WRITE-order.
- A - **Connection error**

The connection is not (yet) established. The message disappears as soon as the connection is stable. If all connections are interrupted, please check the block itself and the bus cable. Another possibility for the occurrence of this error is a wrong parameterization, like e.g. inconsistent addressing.
- B - **Handshake error**

This could be a system error or the size of the data blocks has been defined out of range.
- C - **Initial error**

The wrong handling block tried to initialize the order or the size of the given data block was too large.
- D - **Cancel after RESET**

This is a normal system message. With PRIO 1 and 2 the connection is interrupted but will be established again, as soon as the communication partner is online. PRIO 3 connections are deleted, but can be initialized again.
- E - **Order with basic load function**

This is a normal system message. This order is a READ/WRITEPASSIV and can not be started from the AG.

- F - **Order not found**The called order is not parameterized on the CP. This error may occur when the SSNR/A-No. combination in the handling block is wrong or no connection block is entered.

The bits 4 to 7 of byte 2 are reserved for extensions.

Status management Byte 1, Bit 0 ... Bit 3

Here you may see if an order has already been started, if an error occurred or if this order is blocked, e.g. a virtual connection doesn't exist any longer.

■ Bit 0 - Handshake convenient

- Set:

Per plug-in according to the "delete"-announcement in the order status bit: Handshake convenient (= 1) is used at the RECEIVE block (telegram exists at PRIO 1 or RECEIVE impulse is possible at PRIO 2/3)

- Analyze:

Per RECEIVE block: The RECEIVE initializes the handshake with the CP only if this bit is set. Per application: for RECEIVE request (request a telegram at PRIO 1).

■ Bit 1 - Order is running

- Set:

Per plug-in: when the CP received the order.

- Delete:

Per plug-in: when an order has been commissioned (e.g. receipt received).

- Analyze:

Per handling blocks: A new order is only send, when the order before is completely commissioned. Per user: when you want to know, if triggering a new order is convenient.

■ Bit 2 - Order ready without errors

- Set:

Per plug-in: when the according order has been commissioned without errors.

- Delete:

Per plug-in: when the according order is triggered for a second time.

- Analyze:

Per user: to proof that the order has been commissioned without errors.

■ Bit 3 - Order ready with errors

- Set:

Per plug-in: when the according order has been commissioned with errors. Error causes are to find encrypted in the high-part of the indicator word.

- Delete:

Per plug-in: when the according order is triggered for a second time.

- Analyze:

Per user: to proof that the order has been commissioned with errors. If set, the error causes are to find in the highbyte of the indicator word.

**Data management Byte 1,
Bit 4 ... Bit 7**

Here you may check if the data transfer is still running or if the data fetch res. transmission is already finished. By means of the bit "Enable/Disable" you may block the data transfer for this order (Disable = 1; Enable = 0).

- **Bit 4 - Data fetch / Data transmission is active**

- Set:
Per handling block SEND or RECEIVE, if the fetch/transmission has been started, e.g. when data is transferred with the ALL-function (DMA-replacement), but the impulse came per SEND-DIRECT.
- Delete:
Per handling blocks SEND or RECEIVE, if the data transfer of an order is finished (last data block has been transferred).
- Analyze:
Per user: During the data transfer CP <<->> AG the user must not change the record set of an order. This is uncritical with PRIO 0/1 orders, because here the data transfer is realizable in one block cycle. Larger data amounts however are transferred in blocks during more AG cycles. To ensure data consistency you should proof that the data block isn't in transfer any more before you change the content!

- **Bit 5 - Data transmission is active**

- Set:
Per handling block SEND, when the data transition for an order is ready.
- Delete:
Per handling block SEND, when the data transfer for a new order has been started (new trigger). Per user: When analysis is ready (flank creation).
- Analyze:
Per user: Here you may ascertain, if the record set of an order has already been transferred to the CP res. at which time a new record set concerning a running order (e.g. cyclic transition) may be started.

- **Bit 6 - Data fetch active**

- Set:
Per RECEIVE, when data fetch for a new order has been finished.
- Delete:
Per RECEIVE, when data transfer to AG for a new order (new trigger) has been started. Per user, when analyzing (edge creation).
- Analyze:
Per user: Here you may ascertain, if the record set of an order has already been transferred to the CP res. at what time a new record set for the current order has been transferred to the AG.

- **Bit 7 - Disable/Enable data block**

- Set:
Per user: to avoid overwriting an area by the RECEIVE block res. data transition of an area by the SEND block (only for the first data block).
- Delete:
Per user: to release the according data area.
- Analyze:
Per handling blocks SEND and RECEIVE: if Bit 7 is set, there is no data transfer anymore, but the blocks announce an error to the CP.

Length word Byte 2 and Byte 3

In the length word the handling blocks (SEND, RECEIVE) store the already transferred data of the current order, i.e. the received data amount for receiving orders, the sent data amount for sending orders.

Describe: - Per SEND, RECEIVE during the data transfer. The length word is calculated from: current transfer amount + amount of already transferred data

Delete: - Per overwrite res. with every new SEND, RECEIVE, FETCH. If the bit "order ready without error" res. "Data fetch/data transition ready" is set, the "Length word" contains the current source res. destination length. If the bit "order ready with error" is set, the length word contains the data amount transferred before the failure occurred.

Status and error reports

The following section lists important status and error messages of the CPU that can appear in the "Indicator word". The representation is in "HEX" patterns. The literal X means "not declared" res. "irrelevant"; No. is the error number.

X F X A - The error index "F" shows, that the according order is not defined on the CP. The state index "A" causes a block of this order (for SEND/FETCH and RECEIVE).

X A X A - The error index "A" shows that the connection of the communication order is not (yet) established. Together with the state index "A" SEND, RECEIVE and FETCH are blocked.

X 0 X 8 - The connection has been established again (e.g. after a CP reboot), the SEND order is released (SEND-communication order).

X 0 X 9 - The connection has been established again, the RECEIVE order is released (RECEIVE-communication order).

X 0 2 4 - SEND has been worked off without errors, the data was transferred.

X 0 4 5 - RECEIVE was successful, the data arrived at the AG.

X 0 X 2 - The SEND-, RECEIVE-, READ- res. WRITE order is still running. At SEND the partner is not yet ready for RECEIVE or vice versa.

Important indicator word states**Messages at SEND**

State at H1	Prio 0/1	Prio 2	Prio 3/4
State at TCP/IP	Prio 1	Prio 2	Prio 3
after reboot	0 A 0 A	0 A 0 A	0 0 0 8
after connection start	X 0 X 8	X 0 X 8
after initial impulse	X 0 X 2	X 0 X 2	X 0 X 2
ready without error	X 0 2 4	X 0 2 4	X 0 2 4
ready with error	X No X 8	X No X 8	X No X 8
after RESET	X D X A	X D X A	X D X 8

Messages at RECEIVE

State at H1	Prio 0/1	Prio 2	Prio 3/4
State at TCP/IP	Prio 1	Prio 2	Prio 3
after reboot	0 A 0 A	0 A 0 A	0 0 0 1
after connection start	X 0 X 4	X 0 0 9
after initial impulse	X 0 X 2	X 0 X 2	X 0 X 2
Telegram here	X 0 X 1
ready without error	X 0 4 1	X 0 4 5	X 0 4 5
ready with error	X No X 8	X No X 9	X No X 9
after RESET	X D X A	X D X A	X D X 9

Messages at READ/WRITE-ACTIVE

State at H1	Prio 0/1	Prio 2	Prio 3/4
State at TCP/IP	Prio 1	Prio 2	Prio 3
after reboot		0 A 0 A	
after connection start		X 0 0 8	
after initial impulse		X 0 X 2	
READ ready		X 0 4 4	
WRITE ready		X 0 2 4	
ready with error		X No X 8	
after RESET		X D X A	

16.1.2.5 Parameterization error *PAFE*

The parameterization error byte *PAFE* is set (output or bit memory), when the block detects a "parameterization error", e.g. there is no interface or there is an invalid parameterization of *QANF* / *ZANF*. *PAFE* has the following structure:

Byte	Bit 7 ... Bit 0
0	<ul style="list-style-type: none"> ■ Bit 0: error <ul style="list-style-type: none"> – 0: no error – 1: error, error-No. in Bit 4 ... Bit 7 ■ Bit 3 ... Bit 1: reserved ■ Bit 7 ... Bit 4: error number <ul style="list-style-type: none"> – 0: no error – 1: wrong ORG-Format – 2: area not found (DB not found) – 3: area too small – 4: QVZ-error – 5: wrong indicator word – 6: no Source-/Destination parameters at SEND/RECEIVE ALL – 7: interface not found – 8: interface not specified – 9: interface overflow – A: reserved – B: invalid order-No. – C: interface of CP doesn't quit or is negative – D: Parameter <i>BLGR</i> not allowed – E: reserved – F: reserved

16.1.3 SFC 230 - SEND - Send to page frame

Description

The SEND block initializes a send order to a CP. Normally SEND is called in the cyclic part of the user application program. Although the insertion of this block into the interrupt or the time-alarm program part is possible, the indicator word (*ANZW*), however, may not be updated cyclically. This should be taken over by a CONTROL block.

The connection initialization with the CP for data transmission and for activating a SEND impulse is only started, if:

- the FB RLO (result of operation) received "1".
- the CP released the order.
(Bit "order active" in *ANZW* = 0).

During block stand-by, only the indicator word is updated.

Parameters

Name	Declaration	Type	Description
SSNR	IN	INT	Interface number
ANR	IN	INT	Job number
IND	IN	INT	Mode of addressing
QANF	IN	ANY	Pointer to data source
PAFE	OUT	BYTE	Parameterization error
ANZW	IN_OUT	DWORD	Indicator word

SEND_ALL for data transmission

If the CP is able to take over the data directly, the SEND block transfers the requested data in one session. If the CP requests only the order parameters or the amount of the depending data is too large, the CP only gets the sending parameters res. the parameter with the first data block. The according data res. the assigned serial blocks for this order are requested from the CP by SEND_ALL to the CPU. For this it is necessary that the block SEND_ALL is called minimum one time per cycle. The user interface is for all initialization types equal, only the transfer time of the data is postponed for minimum one CPU cycle.

16.1.4 SFC 231 - RECEIVE - Receive from page frame

Description

The RECEIVE block receives data from a CP. Normally the RECEIVE block is called in the cyclic part of the user application program. Although the insertion of this block into the interrupt or the waking program part is possible, the indicator word cannot be updated cyclically. This should be taken over by a CONTROL block.

The handshake with the CP (order initialization) and for activating a RECEIVE block is only started, if

- the FB RLO received "1".
- the CP released the order (Bit "Handshake convenient" = 1).

Parameters

Name	Declaration	Type	Description
SSNR	IN	INT	Interface number
ANR	IN	INT	Job number
IND	IN	INT	Mode of addressing
ZANF	IN	ANY	Pointer to data destination
PAFE	OUT	BYTE	Parameterization error
ANZW	IN_OUT	DWORD	Indicator word

If the block runs in stand-by only the indicator word is updated. The RECEIVE block reacts different depending from the kind of supply and the CP reaction:

- If the CP transmits a set of parameters although the RECEIVE block itself got destination parameters, the parameter set of the block has the priority above those of the CP.
- Large amounts of data can only be transmitted in blocks. Therefore you have to transmit the assigned serial blocks by means of RECEIVE_ALL to the CPU. It is necessary that the block RECEIVE_ALL is called minimum one time per application cycle and CP interface, if you want to transmit larger data amounts. You also have to integrate the RECEIVE_ALL cyclically, if the CP only uses the RECEIVE for releasing a receipt telegram and the data is transmitted via the background communication of the CPU.

16.1.5 SFC 232 - FETCH - Fetch from page frame

Description

The FETCH block initializes a FETCH order in the partner station. The FETCH order defines data source and destination and the data source is transmitted to the partner station. The CPU from VIPA realizes the definition of source and destination via a pointer parameter. The partner station provides the Source data and transmits them via SEND_ALL back to the requesting station. Via RECEIVE_ALL the data is received and is stored in Destination. The update of the indicator word takes place via FETCH res. CONTROL.

The handshake for initializing FETCH is only started, if

- the FB RLO receives "1".
- the function has been released in the according CP indicator word (order active = 0).

Parameters

Name	Declaration	Type	Description
SSNR	IN	INT	Interface number
ANR	IN	INT	Job number
IND	IN	INT	Mode of addressing
ZANF	IN	ANY	Pointer to data destination
PAFE	OUT	BYTE	Parameterization error
ANZW	IN_OUT	DWORD	Indicator word



Information for indirect parameterization ↗ Chap. 16.1.2.3 'Source res. destination definition' page 887

16.1.6 SFC 233 - CONTROL - Control page frame

Description

The purpose of the CONTROL block is the following:

- Update of the indicator word
- Query if a certain order of the CP is currently "active", e.g. request for a receipt telegram
- Query the CP which order is recently in commission

The CONTROL block is not responsible for the handshake with the CP, it just transfers the announcements in the order status to the parameterized indicator word. The block is independent from the RLO and should be called from the cyclic part of the application.

Parameters

Name	Declaration	Type	Description
SSNR	IN	INT	Interface number
ANR	IN	INT	Job number
PAFE	OUT	BYTE	Parameterization error
ANZW	IN_OUT	DWORD	Indicator word

ANR

If $ANR \neq 0$, the indicator word is built up and handled equal to all other handling blocks. If the parameter ANR gets 0, the CONTROL command transmits the content of the order state cell 0 to the LOW part of the indicator words. The order state cell 0 contains the number of the order that is in commission, e.g. the order number of a telegram (set by the CP).

16.1.7 SFC 234 - RESET - Reset page frame

Description

The RESET ALL function is called via the order number 0. This resets all orders of this logical interface, e.g. deletes all order data and interrupts all active orders. With a direct function ($ANR \neq 0$) only the specified order will be reset on the logical interface. The block depends on the RLO and may be called from cyclic, time or alarm controlled program parts.

Parameters

Name	Declaration	Type	Description
SSNR	IN	INT	Interface number
ANR	IN	INT	Job number
PAFE	OUT	BYTE	Parameterization error

Operating modes

The block has two different operating modes:

- RESET ALL
- RESET DIRECT

16.1.8 SFC 235 - SYNCHRON - Synchronization page frame

Description

The SYNCHRON block initializes the synchronization between CPU and CP during the boot process. For this it has to be called from the starting OBs. Simultaneously the transition area of the interface is deleted and predefined and the CP and the CPU agree about the block size.

Parameters

Name	Declaration	Type	Description
SSNR	IN	INT	Interface number
BLGR	IN	INT	Block size
PAFE	OUT	BYTE	Parameterization error

Block size

To avoid long cycle run-times it is convenient to split large data amounts into smaller blocks for transmitting them between CP and CPU. You declare the size of these blocks by means of "block size". A large block size = high data throughput, but also longer run-times and therefore a high cycle time strain. A small block size = smaller data throughput, but also shorter run-times of the blocks. Following block sizes are available:

Value	Block size	Value	Block size
0	Default (64byte)	4	128byte
1	16byte	5	256byte
2	32byte	6	512byte
3	64byte	255	512byte

Parameter type: Integer
Valid range: 0 ... 255

16.1.9 SFC 236 - SEND_ALL - Send all to page frame

Description

Via the SEND_ALL block, the data is transmitted from the CPU to the CP by using the declared block size. Location and size of the data area that is to transmit with SEND_ALL, must be declared before by calling SEND res. FETCH. In the indicator word that is assigned to the concerned order, the bit "Enable/Disable" is set, "Data transmission starts" and "Data transmission running" is calculated or altered.

Parameters

Name	Declaration	Type	Description
SSNR	IN	INT	Interface number
PAFE	OUT	BYTE	Parameterization error
ANZW	IN_OUT	DWORD	Indicator word

ANZW

In the indicator word of the block, that is parameterized in the SEND_ALL block, the current order number is stored (0 means stand-by). The amount of the transmitted data for one order is shown in the data word of SEND_ALL which follows the indicator word.



In the following cases, the SEND_ALL command has to be called for minimum one time per cycle of the block OB 1:

- *if the CP is able to request data from the CPU independently.*
- *if a CP order is initialized via SEND, but the CP still has to request the background communication data of the CPU for this order.*
- *if the amount of data, that should be transmitted by this SEND to the CP, is higher than the declared block size.*

16.1.10 SFC 237 - RECEIVE_ALL - Receive all from page frame

Description

Via the RECEIVE_ALL block, the data received from the CP is transmitted from the CP to the CPU by using the declared block size. Location and size of the data area that is to transmit with RECEIVE_ALL, must be declared before by calling RECEIVE. In the indicator word that is assigned to the concerned order, the bit "Enable/Disable" is set, "Data transition starts" and "Data transition/fetch running" is analyzed or altered. The receiving amount is shown in the following word.

Parameters

Name	Declaration	Type	Description
SSNR	IN	INT	Interface number
PAFE	OUT	BYTE	Parameterization error
ANZW	IN_OUT	DWORD	Indicator word

ANZW

In the indicator word of the block, that is parameterized in the RECEIVE_ALL block, the current order number is stored. In the stand-by running mode of RECEIVE_ALL the block indicator word is deleted.



In the following cases, the RECEIVE_ALL command has to be called for minimum one time per cycle of the block OB 1:

- *if the CP should send data to the CPU independently.*
- *if a CP order is initialized via RECEIVE, but the CP still has to request the "background communication" data of the CPU for this order.*
- *if the amount of data that should be transmitted to the CPU by this RECEIVE, is higher than the declared block size.*

16.1.11 SFC 238 - CTRL1 - Control1 page frame

Description

This block is identical to the CONTROL block SFC 233 except that the indicator word is of the type Pointer and that it additionally includes the parameter *IND*, reserved for further extensions. The purpose of the CONTROL block is the following:

- Update of the indicator word.
- Query if a certain order of the CP is currently active, e.g. request for a receipt telegram
- Query the CP which order is recently in commission

The CONTROL block is not responsible for the handshake with the CP; it just transfers the announcements in the order status to the parameterized indicator word. The block is independent from the RLO and should be called from the cyclic part of the application.

Parameters

Name	Declaration	Type	Description
SSNR	IN	INT	Interface number
ANR	IN	INT	Job number
IND	IN	INT	Reserved
PAFE	OUT	BYTE	Parameterization error
ANZW	IN_OUT	DWORD	Indicator word

ANR

If *ANR* \neq 0, the indicator word is built up and handled equal to all other handling blocks. If the parameter *ANR* gets 0, the CONTROL command transmits the content of the order state cell 0 to the LOW part of the indicator words. The order state cell 0 contains the number of the order that is in commission, e.g. the order number of a telegram (set by the CP).

IND

The parameter *IND* has no functionality at this time and is reserved for further extensions.

ANZW

The indicator word *ANZW* is of the type Pointer. This allows you to store the indicator word in a data block.

16.2 MMC Functions standard CPUs

16.2.1 SFC 220 ... 222 - MMC Access

Overview

By means of these blocks there is the possibility to integrate MMC access to your application program. Here a new file may be created respectively an existing file may be opened for accessed when a MMC is plugged-in. As long as you do not open another file, you may access this file via read/write commands.

Restrictions

For deploying the SFCs 220, 221 and 222, you have to regard the following restrictions:

- A read res. write access to the MMC is only possible after creation res. opening of the file via SFC 220.
- The data on MMC must not be fragmented, for only complete data blocks may be read res. written.
- When transferring data to the MMC from an external reading device, they may be fragmented, i.e. the data is divided into blocks. This may be avoided by formatting the MMC before the write access.
- At a write access from the CPU to the MMC, the data is always stored not fragmented.
- When opening an already existing file, you have to use the same *FILENAME* and *FILESIZE* that you used at creation of this file.
- A MMC is structured into sectors. Every sector has a size of 512byte. Sector overlapping writing or reading is not possible. Access to sector overlapping data is only possible by using a write res. read command for every sector. By giving the offset, you define the according sector.

The following picture shows the usage of the single SFCs and their variables:

CPU

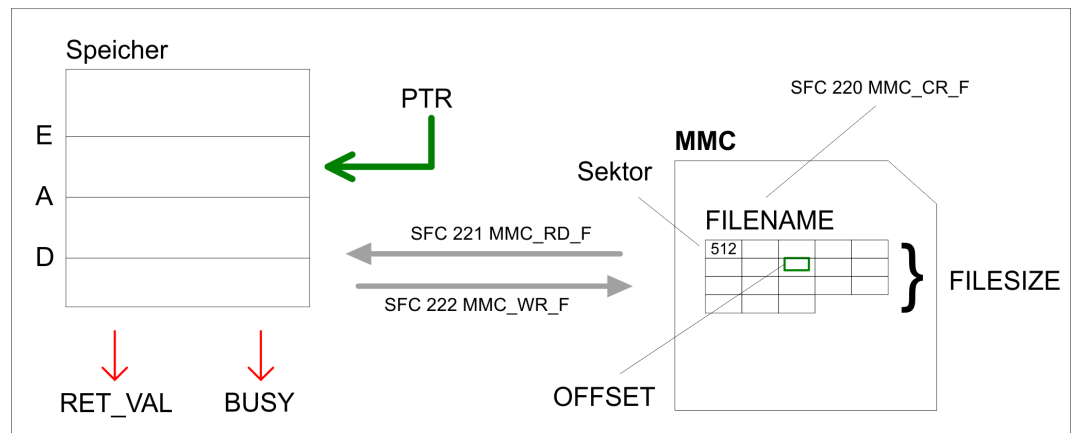

For read and write accesses to the MMC, you firstly have to open the file with SFC 220!

16.2.2 SFC 220 - MMC_CR_F - create or open MMC file

Overview

By means of this SFC a new file may be created respectively an existing file may be opened for accessed when a MMC is plugged-in. As long as you do not open another file, you may access this file via read/write commands. For more detailed information to this and to the restrictions ↪ *Chap. 16.2.1 'SFC 220 ... 222 - MMC Access' page 906.*



Since calling the SFC from the OB 1 can result in a cycle time-out, instead of this you should call the SFC from the OB 100.

Parameters

Name	Declaration	Type	Description
FILENAME	IN	STRING[254]	Name of file
FILESIZE	IN	DWORD	Size of file
RET_VAL	OUT	WORD	Return value (0 = OK)

FILENAME

Type in the file name used to store the data on the MMC. The name inclusive end ID may not exceed a maximum length of 13 characters:

- 8 characters for name
- 1 character for "."
- 3 characters for file extension
- 1 character 00h as end ID



For software technical reasons you have to enter 00h into the byte next to the file name (end ID of the file name).

FILESIZE

The *FILESIZE* defines the size of the user data in byte. When accessing an already existing file, it is mandatory to give not only the *FILENAME* but also the *FILESIZE*. The entry of a "Joker" length is not supported at this time.

Structure

Byte 0	Byte 1	Byte 2	Byte 3	...	Byte 255
Max. length	occupied length	ASCII value 1	ASCII value 2	...	ASCII value 254

RET_VAL (Return Value)

Word that returns a diagnostic/error message. 0 means OK.

Value	Description
<i>Diagnostic messages</i>	
0000h	No errors (appears if new file is generated).
0001h	File already exists, is not fragmented and the length value is identical or smaller.
8001h	No or unknown type of MMC is plugged-in.
<i>Error messages</i>	
8002h	No FAT on MMC found.
A001h	File name missing. This message appears if file name is inside a not loaded DB.

MMC Functions standard CPUs > SFC 221 - MMC_RD_F - read from MMC file

Value	Description
A002h	File name wrong (not 8.3 or empty)
A003h	File exists but <i>FILESIZE</i> too bigger than existing file.
A004h	File exists but is fragmented and cannot be opened.
A005h	Not enough space on MMC.
A006h	No free entry in root directory. Depending on the used MMC there may be min. 16 up to max. 512 entries in the root directory.
B000h	An internal error occurred.

16.2.3 SFC 221 - MMC_RD_F - read from MMC file

Description

Via the SFC 221 you may read data from a MMC. For read and write accesses to the MMC, you firstly have to open the file with SFC 220 and it has to be not fragmented. For more detailed information to this and to the restrictions ↪ *Chap. 16.2.1 'SFC 220 ... 222 - MMC Access' page 906.*

Parameters

Name	Declaration	Type	Description
PTR	IN	ANY	Pointer to area for reading data
OFFSET	IN	DWORD	Offset of data within the file
BUSY	OUT	BOOL	Job state
RET_VAL	OUT	WORD	Return value (0 = OK)

PTR This variable of the type pointer points to a data area in the CPU where the content of the MMC has to be written to.

OFFSET Here you define the start address inside the file on the MMC from where on the data has to be transferred to the CPU.

BUSY During data transfer this bit remains set. The bit is reset as soon as the data transfer is complete.

RET_VAL (Return Value) Word that returns a diagnostic/error message. 0 means OK.

Value	Description
0000h	No errors (data was read)
8001h	No or unknown type of MMC is plugged-in
8002h	No FAT found on MMC
9000h	Bit reading has been tried (Boolean variable). Bit reading is not possible.
9001h	Pointer value is wrong (e.g. points outside DB)

Value	Description
9002h	File length exceeded
9003h	Sector limit of 512 has been tried to overrun. Sector overrun reading is not possible.
B000h	An internal error occurred.

16.2.4 SFC 222 - MMC_WR_F - write to MMC file

Description Via the SFC 222, you may write to the MMC. For read and write accesses to the MMC, you firstly have to open the file with SFC 220 and it has to be not fragmented. For more detailed information to this and to the restrictions ↪ *Chap. 16.2.1 'SFC 220 ... 222 - MMC Access' page 906.*

Parameters

Name	Declaration	Type	Description
PTR	IN	ANY	Pointer to area for writing data
OFFSET	IN	DWORD	Offset of data within the file
BUSY	OUT	BOOL	Job state
RET_VAL	OUT	WORD	Return value (0 = OK)

PTR This variable of the type pointer points to a data area from where on the data starts that will be written to the MMC.

OFFSET This defines the beginning of the data inside the file on the MMC where the data is written to.

BUSY During data transfer this Bit remains set. The Bit is reset as soon as the data transfer is complete.

RET_VAL (Return Value) Word that returns a diagnostic/error message. 0 means OK.

Value	Description
0000h	No errors
8001h	No or unknown type of MMC is plugged-in.
8002h	No FAT found on MMC.
9000h	Bit writing has been tried (Boolean variable). Bit writing is not possible.
9001h	Pointer value is wrong (e.g. points outside DB).
9002h	File length exceeded.
9003h	Sector limit of 512 has been tried to overrun. Sector overrun reading is not possible.
B000h	An internal error occurred.

16.3 File Functions SPEED7 CPUs

16.3.1 FC/SFC 195 and FC/SFC 208...215 - Memory card access

Overview

The FC/SFC 195 and FC/SFC 208 ... FC/SFC 215 allow you to include the memory card access into your user application. The following parameters are necessary for the usage of the FC/SFCs:

HANDLE, FILENAME

The access takes place via a *HANDLE* number. That is assigned to a *FILENAME* via a call of the FC/SFC 208 FILE_OPN res. FC/SFC 209 FILE_CRE. At the same time a max. of 4 *HANDLE* may be opened (0 ... 3). To close an opened file call the FC/SFC 210 FILE_CLO and thus release the *HANDLE* again.

MEDIA

As media format set 0 for the MMC. Other formats are not supported at this time.

ORIGIN, OFFSET

Read and write start with the position of a write/read flag. After opening res. creation of a file, the write/read flag is at position 0. With FC/SFC 213 FILE_SEK you may shift the write/read flag from an *ORIGIN* position for an *OFFSET* (number Bytes).

REQ, BUSY

- With *REQ* = 1 you activate the according function.
- *REQ* = 0 returns the current state of a function via *RETVAL*.
- *BUSY* = 1 monitors that the according function is in process.

RETVAL

After the execution of a function *RETVAL* returns a number code:

RETVAL = 0:	Function has been executed without errors.
0 < RETVAL < 7000h:	<i>RETVAL</i> = Length of the transferred data (only FC/SFC 211 and FC/SFC 212).
7000h ≤ RETVAL < 8000h:	Monitors the execution state of the function.
RETVAL ≥ 8000h:	Indicates an error that is described more detailed in the according FC/SFC.



CAUTION!

For the access of the memory card you must regard the following hints. Nonobservance may cause data loss at the memory card:

- A max. of 4 Handle (0 ... 3) may be used at the same time!
- File names must follow the 8.3 format or special character!
- These FC/SFCs only gives you access to the top directory level (Root directory) of the memory card!
- You may only rename or delete files that you've closed before with FC/SFCs 210 FILE_CLO!

16.3.2 FC/SFC 195 - FILE_ATT - Change file attributes

Description

In the root directory of the memory card the file attributes may be changed by FILE_ATT. Here enter a file name. The corresponding attributes may be reset with *ATTRIBCLEANMASK* respectively set with *ATTRIBSETMASK* by given bit pattern. Setting takes priority over resetting. After job execution the current state of the attributes is returned with *RETVAL* 00xxh. For determination of the current file attributes by *RETVAL*, the parameters *ATTRIBCLEANMASK* and *ATTRIBSETMASK* may be set to value 00h.

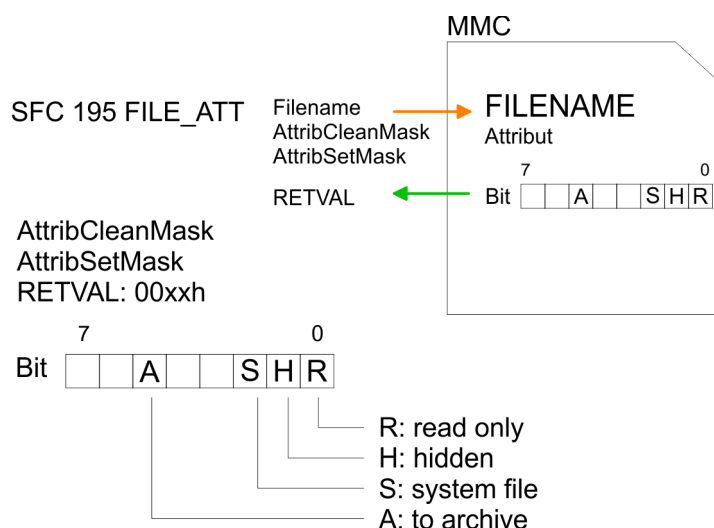

Parameters

Parameter	Declaration	Data type	Description
REQ	IN	BOOL	Activate function
MEDIA	IN	INT	0 = MMC
FILENAME	IN	STRING[254]	Name of file (must be in 8.3 format)
ATTRIBCLEANMASK	IN	BYTE	Bit pattern of attributes to clean
ATTRIBSETMASK	IN	BYTE	Bit pattern of attributes to set
RETVAL	OUT	WORD	Return value (00xxh=OK with xx: attributes)
BUSY	OUT	BOOL	Function is busy

RETVAL (Return value) Return codes of *RETVAL*:

Code	Description
00xxh	OK, attributes have been changed with xx: attributes
7000h	<i>REQ</i> = 0, <i>BUSY</i> = 0 (nothing present)
7001h	<i>REQ</i> = 1, 1. call
7002h	Block is executed
A001h	The defined <i>MEDIA</i> type is not valid
A002h	Error in parameter <i>ATTRIBSETMASK</i>

Code	Description
A004h	File <i>FILENAME</i> is not found
A005h	<i>FILENAME</i> is a directory
A006h	File is just open
A007h	Memory card is write protected
A010h	File error <i>FILENAME</i>
A100h	General file system error (e.g. no memory card plugged)

16.3.3 FC/SFC 208 - FILE_OPN - Open file

Description

You may open a file on the memory card with FC/SFC 208. Here a *HANDLE* is connected to a *FILENAME*. By using the *HANDLE* you now have read and write access to the file until you close the file again with the FC/SFC 210 FILE_CLO. *REQ* = 1 initializes the function. After the opening the read/write flag is at 0.

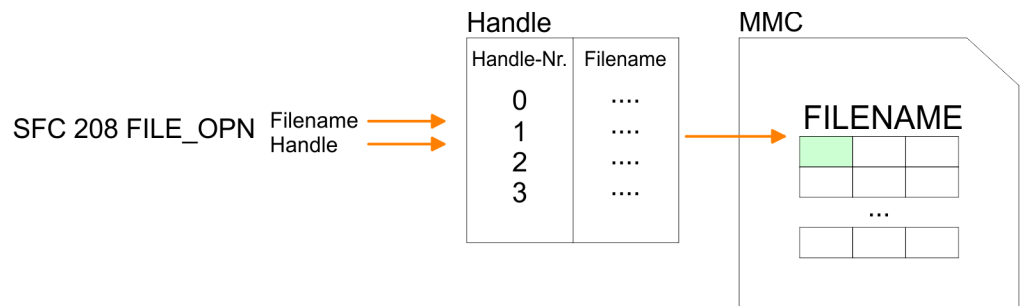

Parameters

Parameter	Declaration	Data type	Description
REQ	IN	BOOL	Activate function
MEDIA	IN	INT	0 = MMC
FILENAME	IN	STRING[254]	Name of file (must be in 8.3 format)
HANDLE	IN	INT	Index of file 0 ... 3
RETVAL	OUT	WORD	Return value (0 = OK)
BUSY	OUT	BOOL	Function is busy

RETVAL (Return value) Codes that are returned by *RETVAL*:

Code	Description
0000h	OK
7000h	<i>REQ</i> = 0, <i>BUSY</i> = 0 (nothing present)
7001h	<i>REQ</i> = 1, 1. call
7002h	Block is executed
8010h	Parameter <i>FILENAME</i> is not present (e.g. DB not loaded).

Code	Description
8011h	Error <i>FILENAME</i> (not conform with 8.3 or special character)
8100h	The defined <i>HANDLE</i> is not valid
9001h	<i>HANDLE</i> is assigned to another file
9002h	Another function has been called via this <i>HANDLE</i> and is ready
9003h	Another function has been called via this <i>HANDLE</i> and is ready
A000h	System internal error occurred
A001h	The defined <i>MEDIA</i> type is not valid
A003h	A general error in the file system occurred
A004h	The in <i>FILENAME</i> defined file doesn't exist or is a directory
A100h	General file system error (e.g. no memory card plugged)

16.3.4 FC/SFC 209 - FILE_CRE - Create file

Description

By using this block you may create a new file with the entered file name on the memory card (if plugged) and open it for read/write access. Please regard that you may only create files at the top directory level. *REQ* = 1 initializes the function. After opening, the write /read flag is at 0.

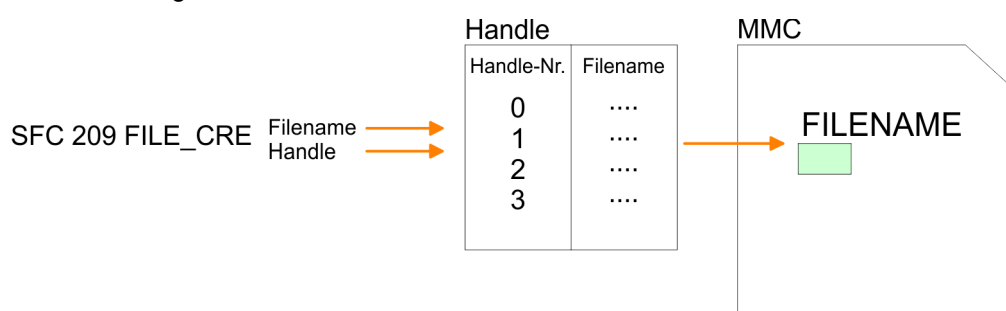

Parameters

Parameter	Declaration	Data type	Description
REQ	IN	BOOL	Activate function
MEDIA	IN	INT	0 = MMC
FILENAME	IN	STRING[254]	Name of file (must be in 8.3 format)
HANDLE	IN	INT	Index of file 0 ... 3
RETVAL	OUT	WORD	Return value (0 = OK)
BUSY	OUT	BOOL	Function is busy

RETVAL (Return value) Codes that are returned by RETVAL:

Code	Description
0000h	OK
7000h	<i>REQ</i> = 0, <i>BUSY</i> = 0 (nothing present)
7001h	<i>REQ</i> = 1, 1. call
7002h	Block is executed
8010h	Parameter <i>FILENAME</i> is not present (e.g. DB not loaded)
8011h	Error <i>FILENAME</i> (not conform with 8.3 or special character)
8100h	The defined <i>HANDLE</i> is not valid
9001h	<i>HANDLE</i> is assigned to another file
9002h	Another function has been called via this <i>HANDLE</i> and is ready
9003h	Another function has been called via this <i>HANDLE</i> and is not ready
A000h	System internal error occurred
A001h	The defined <i>MEDIA</i> type is not valid
A003h	A general error in the file system occurred
A004h	No root-entry is available in the directory
A005h	Memory card is write-protected
A100h	General file system error (e.g. no memory card plugged)

16.3.5 FC/SFC 210 - FILE_CLO - Close file

Description

This block allows you to close an opened file. Here an EOF (**End of File**) is added, the file is closed and the *HANDLE* released. *REQ* = 1 initializes the function.

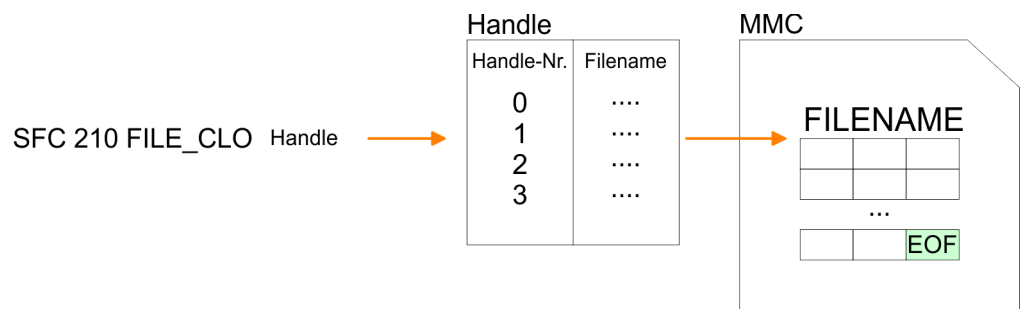

Parameters

Parameter	Declaration	Data type	Description
REQ	IN	BOOL	Activate function
HANDLE	IN	INT	Index of file 0 ... 3
RETVAL	OUT	WORD	Return value (0 = OK)
BUSY	OUT	BOOL	Function is busy

RETVAL (Return value) Codes that are returned by *RETVAL*:

Code	Description
0000h	OK
7000h	<i>REQ</i> = 0, <i>BUSY</i> = 0 (nothing present)
7001h	<i>REQ</i> = 1, 1. call
7002h	Block is executed
8100h	The defined <i>HANDLE</i> is invalid
9001h	The <i>HANDLE</i> is not assigned to a file name
9002h	Another function has been called via this <i>HANDLE</i> and is ready
9003h	Another function has been called via this <i>HANDLE</i> and is not ready
A000h	System internal error occurred
A100h	General file system error (e.g. no memory card plugged)

16.3.6 FC/SFC 211 - FILE_RD - Read file

Description

This allows you to transfer data from the memory card to the CPU via the opened *HANDLE* starting from an *ORIGIN* position (position of the read-/write flag). During every call you may transfer a max. of 512byte. By setting of *DATA* you define storage place and length of the write area in the CPU. *REQ* = 1 initializes the function.

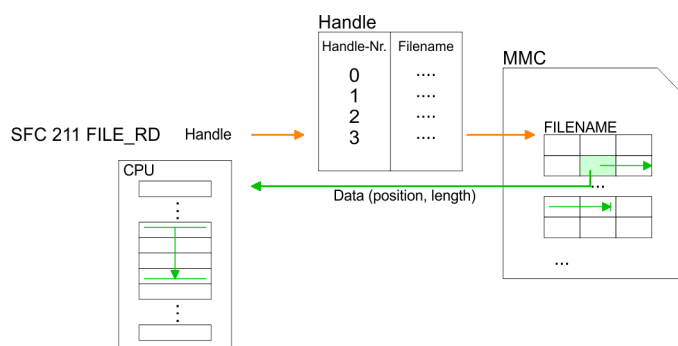

Parameters

Parameter	Declaration	Data type	Description
REQ	IN	BOOL	Activate function
HANDLE	IN	INT	Index of file 0 ... 3
DATA	IN	ANY	Pointer to PLC memory and data length
RETVAL	OUT	WORD	Return value (0 = OK)
BUSY	OUT	BOOL	Function is busy

RETVAL (Return value) Codes that are returned by *RETVAL*:

Code	Description
0xxxh	0 = OK, 0xxx = Length of read data
7000h	<i>REQ</i> = 0, <i>BUSY</i> = 0 (nothing present)
7001h	<i>REQ</i> = 1, 1. call
7002h	Block is executed
8010h	Pointer in <i>DATA</i> has type <i>BOOL</i>
8011h	Pointer in <i>DATA</i> cannot be decoded (e.g. DB not loaded)
8012h	Data length exceeds 512byte
8013h	A write access to a write-protected DB happened
8100h	The defined <i>HANDLE</i> is not valid
9001h	For this <i>HANDLE</i> no file is opened.
9002h	Another function has been called via this <i>HANDLE</i> and is ready
9003h	Another function has been called via this <i>HANDLE</i> and is not ready
A000h	System internal error occurred
A003h	Internal error
A100h	General file system error (e.g. no memory card plugged)

16.3.7 FC/SFC 212 - FILE_WR - Write file

Description

Use this block for write access to the memory card. This writes data from the position and length of the CPU defined under *DATA* to the memory card via the according *HANDLE* starting at the write/read position. During every call you may transfer a max. of 512byte. *REQ* = 1 initializes the function.

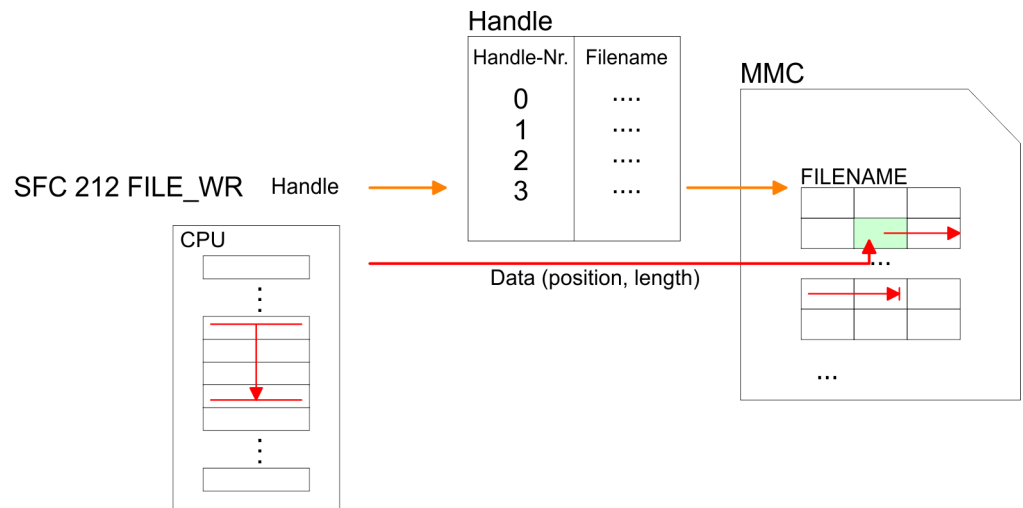

Parameters

Parameter	Declaration	Data type	Description
REQ	IN	BOOL	Activate function
HANDLE	IN	INT	Index of file 0 ... 3

Parameter	Declaration	Data type	Description
DATA	IN	ANY	Pointer to PLC memory and data length
RETVAL	OUT	WORD	Return value
BUSY	OUT	BOOL	Function is busy

The parameter *RETVAL* returns the length of the written data. The block doesn't announce an error message that the MMC is full. The user has to check himself if the number of the bytes to write corresponds to the number of written bytes returned by *RETVAL*.

RETVAL (Return value) Codes that are returned by *RETVAL*:

Code	Description
0xxxh	0 = OK, 0xxx = Length of written data
7000h	<i>REQ</i> = 0, <i>BUSY</i> = 0 (nothing present)
7001h	<i>REQ</i> = 1, 1. call
7002h	Block is executed
8010h	Pointer in <i>DATA</i> has type BOOL
8011h	Pointer in <i>DATA</i> cannot be decoded (e.g. DB not loaded)
8012h	Data length exceeds 512byte
8100h	The defined <i>HANDLE</i> is not valid
9001h	For this Handle no file is opened
9002h	Another function has been called via this <i>HANDLE</i> and is ready
9003h	Another function has been called via this <i>HANDLE</i> and is not ready
A000h	System internal error occurred
A002h	File is write-protected
A003h	Internal error
A004h	Memory card is write-protected
A100h	General file system error (e.g. no memory card plugged)

16.3.8 FC/SFC 213 - FILE_SEK - Position pointer

Description

FILE_SEK allows you to detect res. alter the position of the write-/read flag of the according *HANDLE*. By setting *ORIGIN* as start position and an *OFFSET* you may define the write-/read flag for the according *HANDLE*. *REQ* = 1 starts the function.

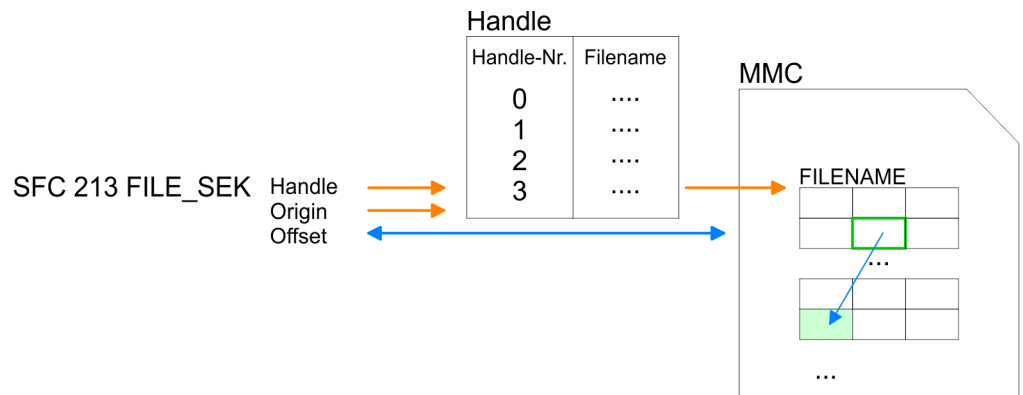

Parameters

Parameter	Declaration	Data type	Description
REQ	IN	BOOL	Activate function
HANDLE	IN	INT	Index of file 0 ... 3
ORIGIN	IN	INT	0 = file start, 1 = current position, 2 = file end
RETVAL	OUT	WORD	Return value (0 = OK)
BUSY	OUT	BOOL	Function is busy
OFFSET	INOUT	DINT	Offset write-/read flag

RETVAL (Return value) Codes that are returned by *RETVAL*:

Code	Description
0000h	OK, <i>OFFSET</i> contains the current write-/read position
7000h	<i>REQ</i> = 0, <i>BUSY</i> = 0 (nothing present)
7001h	<i>REQ</i> = 1, 1. call
7002h	Block is executed
8100h	The defined <i>HANDLE</i> is not valid
9001h	For this <i>HANDLE</i> no file is opened
9002h	Another function has been called via this <i>HANDLE</i> and is ready
9003h	Another function has been called via this <i>HANDLE</i> and is not ready
A000h	System internal error occurred
A004h	<i>ORIGIN</i> parameter is defective
A100h	General file system error (e.g. no memory card plugged)

16.3.9 FC/SFC 214 - FILE_REN - Rename file

Description

Using FILE_REN you may alter the file name defined in *OLDNAME* to the file name that you type in *NEWNAME*.



CAUTION!

Please regard that you may only rename files that you've closed before with FILE_CLO. Nonobservance may cause data loss at the memory card!

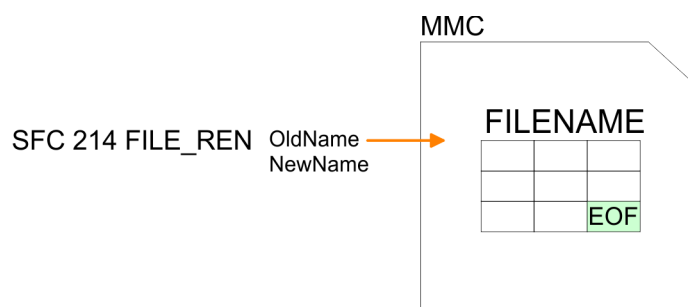

Parameters

Parameter	Declaration	Data type	Description
REQ	IN	BOOL	Activate function
MEDIA	IN	INT	0 = MMC
OLDNAME	IN	STRING[254]	Old name of file (must be in 8.3 format)
NEWNAME	IN	STRING[254]	New name of file (must be in 8.3 format)
RETVAL	OUT	WORD	Return value (0 = OK)
BUSY	OUT	BOOL	Function is busy.

RETVAL (Return value) Codes that are returned by *RETVAL*:

Code	Description
0000h	OK, file has been renamed
7000h	<i>REQ</i> = 0, <i>BUSY</i> = 0 (nothing present)
7001h	<i>REQ</i> = 1, 1. call
7002h	Block is executed
8010h	Parameter <i>OLDNAME</i> is not present (e.g. DB not loaded)
8011h	Error <i>OLDNAME</i> (not conform with 8.3 format or special character)
8020h	Parameter <i>NEWNAME</i> is not present (e.g. DB not loaded)

Code	Description
8021h	Error <i>NEWNAME</i> (not conform with 8.3 format or special character)
A000h	System internal error occurred
A001h	The defined MEDIA type is not valid
A003h	The new filename <i>NEWNAME</i> already exists
A004h	File <i>OLDNAME</i> is not found
A006h	File <i>OLDNAME</i> is just open
A007h	Memory card write-protected
A100h	Error occurs when file creation (e.g. no memory card plugged)

16.3.10 FC/SFC 215 - FILE_DEL - Delete file

Description

This block allows you to delete a file at the memory card. For this, type the file name of the file to delete under *FILENAME*.



CAUTION!

Please regard that you may only delete files that you've closed before with FILE_CLO. Nonobservance may cause data loss at the memory card!

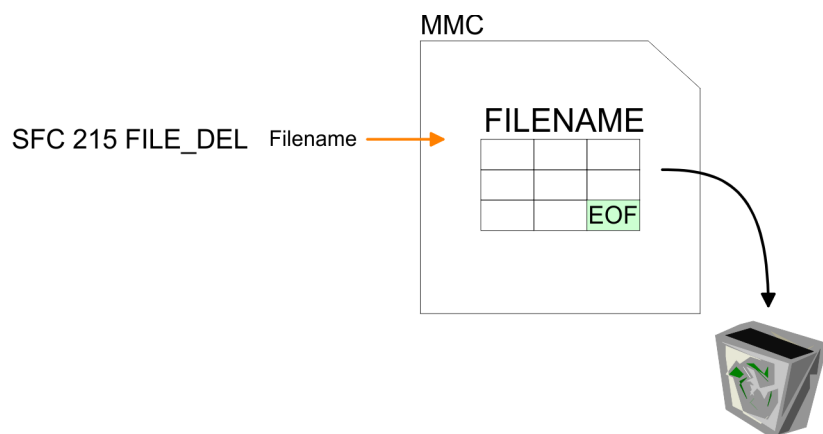

Parameters

Parameter	Declaration	Data type	Description
REQ	IN	BOOL	Activate function
MEDIA	IN	INT	0 = MMC
FILENAME	IN	STRING[254]	Name of file (must be in 8.3 format)
RETVAL	OUT	WORD	Return value (0 = OK)
BUSY	OUT	BOOL	Function is busy.

RETVAL (Return value) Codes that are returned by *RETVAL*:

Code	Description
0000h	OK, file has been deleted
7000h	<i>REQ</i> = 0, <i>BUSY</i> = 0 (nothing present)
7001h	<i>REQ</i> = 1, 1. call
7002h	Block is executed
8010h	Parameter <i>FILENAME</i> is not available (e.g. DB not loaded)
8011h	<i>FILENAME</i> is defective (e.g. is not conform with 8.3 format or special character)
A000h	System internal error occurred
A001h	The defined <i>MEDIA</i> type is not valid
A002h	The file is write-protected
A004h	File <i>FILENAME</i> is not found
A005h	<i>FILENAME</i> is a directory - you cannot delete
A006h	File is just open
A007h	Memory card is write-protected
A100h	General file system error (e.g. no memory card plugged)

16.4 System Functions

16.4.1 SFC 75 - SET_ADDR - Set PROFIBUS MAC address

Description

With this SFC you can change the MAC address of the integrated PROFIBUS interface of a CPU. The function is only possible in the passive DP slave mode. To identify the diagnostic address is used. The SFC is asynchronous and can be applied only to one interface. At STOP and subsequent warm start the set network address is retained. With PowerOFF-PowerON or on overall reset the interface gets the configured node number. The DP slave consistently assumes the identity of the DP slave with the new address. For the DP master the DP slave with the old address fails and a DP slave with the new address returns. If an address is selected, which is already used by another node on the DP line, then both slaves fail in accordance to the DP communication.

Parameters

Parameter	Declaration	Data type	Memory area	Description
REQ	INPUT	BOOL	I, Q, M, D, L	Function request with <i>REQ</i> = 1
LADDR	INPUT	WORD	I, Q, M, D, L	Identification of the interface
ADDR	INPUT	BYTE	I, Q, M, D, L	New node address
RET_VAL	OUTPUT	INT	I, Q, M, D, L	Error code
BUSY	OUTPUT	BOOL	I, Q, M, D, L	<i>BUSY</i> = 1: In progress

RET_VAL (return value)

Value	Description
0000h	Job has been executed without error
7000h	Function request with <i>REQ</i> = 0 (call without processing) <i>BUSY</i> is set to 0, no data transfer is active
7001h	First call with <i>REQ</i> = 1: Data transfer started <i>BUSY</i> is set to 1
7002h	Intermediate call (<i>REQ</i> irrelevant): Data transfer started <i>BUSY</i> is set to 1
8xyyh	General error information ↳ <i>Chap. 4.2 'General and Specific Error Information RET_VAL' page 66</i>
8090h	Identification of the interfaces: Logical address is not valid
8091h	New node address is not valid
8093h	Identification of the interfaces: Logical address is no interface
809Bh	Function not executable (e.g.. interface is no DP slave or active)
80C3h	There are no resources (e.g. multiple call of the SFC)

16.4.2 FC/SFC 193 - AI_OSZI - Oscilloscope-/FIFO function**Description**

- The FC/SFC 193 serves for controlling the oscilloscope-/FIFO function of analog input channels with this functionality.
- It allows to start the recording and to read the buffered data.
- Depending upon the parameterization there are the following possibilities:

Oscilloscope operation

- Depending on the trigger condition at edge evaluation the monitoring of the configured channel may be started respectively at manual operation the recording may be started.
- The recorded measuring values may be accessed by the FC/SFC 193 as soon as the buffer is full.

FIFO operation

- Start the recording.
- Read the puffer at any time.



The FC/SFC may only be called from on level of priority e.g. only from OB 1 or OB 35.

The module is to be parameterized before.

For starting and reading in each case the FC/SFC 193 is to be called. The differentiation of both variants takes place in the parameter MODE.

Parameters

Parameter	Declaration	Data type	Function depending on MODE
REQ	IN	BOOL	Execute function (start/read)
LADR	IN	WORD	Base address of the module
MODE	IN	WORD	Mode (start/read)
CHANNEL	IN	BYTE	Channel to be read
OFFSET	IN	DWORD	Address offset for reading (not FIFO operation)
RECORD	IN	ANY	Memory for the read data
RETVAL	OUT	WORD	Return value (0 = OK)
BUSY	OUT	BOOL	Function is busy
TIMESTAMP	OUT	DWORD	Time stamp (only at edge evaluation)
LEN	INOUT	DWORD	Number of values to be handled per channel

- REQ**
- Depending on the set *MODE* when the bit is set the recording respectively the reading may be started.
 - Depending on the trigger condition at edge evaluation the monitoring of the configured channel may be started respectively at manual operation the recording may be started.
 - The data are read from the module, if "read" is set at *MODE*.

LADR Logical basic address of the module.

- MODE**
- The FC/SFC 193 may be called with 3 different modes. The corresponding mode may be set by the parameter *MODE*. The configured mode is executed by setting *REQ*. The following values are supported:
- 01h: Starts recording respectively edge monitoring depending upon the parameterization.
 - 00h: Read data within several cycles until *BUSY* = 0.
 - 80h: Read data with one access.

CHANNEL Here the channel is specified to be read. With each call one channel may be read. This parameter is irrelevant at start calls with *MODE* = 01h.

- OFFSET**
- Offset specifies an address offset for the reading process. By this you get access to sub-ranges of the recorded data.
 - The value for the maximum offset depends on the number of values, which were recorded per channel.
 - *OFFSET* is not supported in FIFO operation. It will be ignored.

- RECORD**
- Here an area for the read values to be stored at may be defined.
 - In FIFO operation every value of the selected channel may be read, which were stored up to the time of start reading.
 - Please regard that the buffer has a sufficient size for the data to be buffered, otherwise an error is reported.

- BUSY**
- *BUSY* = 1 indicates that the function just processed.
 - *BUSY* = 0 indicates that the function is finished.
- TIMESTAMP**
- There is an internal clock with a resolution of 1µs running in every SPEED-Bus module.
 - The returned value corresponds to the time at the SPEED-Bus module, on which the trigger event occurred.
 - *TIMESTAMP* is only available at the edge triggered oscilloscope operation.
 - It is valid as long as the job is running (*RETV* = 7xxxh) and bit 4 of byte 0 is set respectively the job has been finished without an error (*RETV* = 0000h).

- LEN**
- The length parameter realized as IN/OUT is variably interpreted depending on the selected mode at the function call.
- Mode: start (*MODE*: = 01h)**
- At *MODE* = 01h this parameter may only be used at the manual oscilloscope start. Here the requested number of values per channel to be buffered may be assigned. In this mode there is no value reported by *LEN*.
- Mode: read (*MODE*: = 00h or 80h)**
- At *MODE* = 00h respectively 80h the number of values to be read may be set. This parameter is ignored in FIFO operation. The number of the read values is returned by *LEN*.

- RETV (Return value)**
- In addition to the module specific error codes listed here, there general FC/SFC error information may be returned as well.

RETV	Description depending on the <i>BUSY</i> -Bit	<i>BUSY</i>
Byte		
0	Bit 1, 0:	
	00: Call with <i>REQ</i> : = 0 (idle, waiting for <i>REQ</i> = 1)	0
	01: First call with <i>REQ</i> : = 1	1
	10: Subsequent call with <i>REQ</i> : = 1	1
	11: Oscilloscope is just recording	1
	Bit 2: <i>REQ</i> : = 1, but recording was not yet started. (<i>MODE</i> : = 00h or <i>MODE</i> : = 80h)	0
	Bit 3: reserved	-
	Bit 4: Trigger event occurred and recording is just running.	1
	Bit 5: Waiting for trigger event	1
	Bit 7...6: reserved	-
1	Bit 0: reserved	-
	Bit 1: The number of recorded values exceeds the target area defined by <i>RECORD</i> (in words).	0
	Bit 2: The number of the recorded values exceeds the area defined by <i>LEN</i> and <i>OFFSET</i> .	0
	Bit 3: Buffer overflow in FIFO operation.	0

RETVAL	Description depending on the <i>BUSY</i> -Bit	BUSY
	Bit 7...4:	
	0000: Job finished without an error	0
	0111: Job still running	1
	1000: Job finished with error	0

Job finished without an error

RETVAL	Description depending on the <i>BUSY</i> -Bit	BUSY
0000h	Job was finished without an error.	0

Job finished with error

RETVAL	Description depending on the <i>BUSY</i> -Bit	BUSY
8002h:	Oscilloscope-/FIFO function is not configured.	0
8003h:	An internal error occurred - please contact VIPA.	0
8005h:	The selected channel may not be read - wrong channel number.	0
8007h:	The value at <i>OFFSET</i> exceeds the number of recorded values.	0
8090h:	There is no SPEED-Bus module with this address available.	0
80D2h:	<i>LADR</i> exceeds the peripheral address area.	0

16.4.3 FC/SFC 194 - DP_EXCH - Data exchange with CP342S

Description

With the FC/SFC 194 you can exchange data between your CPU and a PROFIBUS DP master, which is connected via SPEED-Bus. Normally each PROFIBUS DP master embeds its I/O area into the peripheral area of the CPU. Here you can address a periphery range of 0 ... 2047 via the hardware configuration. Since this limits the maximum number of PROFIBUS DP master modules at the SPEED-Bus, there is the possibility to deactivate the mapping at the appropriate DP master and to activate instead the access via handling blocks. Here you can write data from the CPU in a defined area of the DP master and read data from a defined area of the DP master.

Parameters

Parameter	Declaration	Data type	Functionality depending on MODE
LADR	IN	WORD	Base address of the DP master module on the SPEED-Bus
MODE	IN	WORD	Modus (0 = read / 1 = write)
LEN	IN	WORD	Length of the data area in the DP master
OFFSET	IN	DWORD	Begin of the data area in the DP master
RETVAL	OUT	WORD	Return value (0 = OK)
DATA	IN OUT	ANY	Pointer to the data area of the CPU

LADR Logical base address of the module.

MODE Den FC/SFC 194 may be called with the following modes:

- 0000 = Transfer data from the DP master to the CPU.
- 0001 = Transfer data from the CPU to the DP master.

LEN Here the length of the data area in the DP master is defined.

OFFSET Here the beginning of the data area in the DP master is defined. Please consider that the area defined via *OFFSET* and *LEN* does not exceed the area defined of the DP master by the hardware configuration.

RETVAL (Return value) In addition to the module-specific error codes listed here, as return value there are also general error codes possible for FC/SFCs . ↪ *Chap. 4.2 'General and Specific Error Information RET_VAL' page 66*

RETVAL	Description
0000h	No error
8001h	<i>LADR</i> could not be assigned to a DP master at the SPEED-Bus.
8002h	The value of the parameter <i>MODE</i> is out of range.
8003h	The value of the parameter <i>LEN</i> is 0.
8004h	The value of the parameter <i>LEN</i> is greater than the data area defined at <i>DATA</i> .
8005h	The area defined by <i>OFFSET</i> and <i>LEN</i> is out of the range 0 ...2047.

RETVAL	Description
8006h	The DP master specified by <i>LADR</i> is not configured for access via handling block. Activate in the properties of the DP master "IO-Mode HTB".
8008h	There are gap(s) in the input area.
8009h	There are gap(s) in the output area.
8010h	Error while accessing the input area (e.g. DP master is not reachable)
8011h	Error while accessing the output area (e.g. DP master is not reachable)
8Fxxh	Error at DATA (xx) ↪ <i>Chap. 4.2 'General and Specific Error Information RET_VAL' page 66</i>

16.4.4 FC/SFC 219 - CAN_TLGR - CANopen communication

FC/SFC 219 CAN_TLGR SDO request to CAN master

Every SPEED7-CPU provides the integrated FC/SFC 219. This allows you to initialize a SDO read or write access from the PLC program to the CAN master. For this you address the master via the slot number and the destination slave via its CAN address. The process data is defined by the setting of *INDEX* and *SUBINDEX*. Via SDO per each access a max. of one data word process data can be transferred.

Parameters

Parameter	Declaration	Data type	Description
REQUEST	IN	BOOL	Activate function
SLOT_MASTER	IN	BYTE	SPEED-Bus slot (101 ... 116)
NODEID	IN	BYTE	CAN address (1 ... 127)
TRANSFERTYP	IN	BYTE	Type of transfer
INDEX	IN	DWORD	CANopen Index
SUBINDEX	IN	DWORD	CANopen sub index
CANOPENERROR	OUT	DWORD	CANopen error
RETVAL	OUT	WORD	Return value (0 = OK)
BUSY	OUT	BOOL	Function is busy
DATABUFFER	INOUT	ANY	Data Buffer for FC/SFC communication

REQUEST Control parameter: 1: Initialization of the order

SLOT_MASTER 101...116: slot 1 ... 16 from master at SPEED-Bus

NODEID Address of the CANopen node (1...127)

TRANSFERTYPE

40h: Read SDO	23h: Write SDO (1 DWORD)
	2Bh: Write SDO (1 WORD)
	2Fh: Write SDO (1 BYTE)

INDEX CANopen Index

SUBINDEX CANopen sub index

SLOT_MASTER	0:	System 200 CPU 21xCAN
	1...32:	System 200 IM 208CAN
	101...115:	System 300S 342-1CA70

CANOPENERROR When no error occurs, *CANOPENERROR* returns 0. In case of an error *CANOPENERROR* contains one of the following error messages that are created by the CAN master:

Code	Description
0503 0000h	Toggle Bit not alternated
0504 0000h	SDO Time out value reached
0504 0001h	Client/server command specify not valid, unknown
0504 0002h	Invalid block size (only block mode)
0504 0003h	Invalid sequence number (only block mode)
0504 0004h	CRC error (only block mode)
0504 0005h	Insufficient memory
0601 0000h	Attempt to read a write only object
0601 0001h	Attempt to write a read only object
0602 0000h	Object does not exist in the object dictionary
0604 0041h	Object cannot be mapped to the PDO
0604 0042h	The number and length of the objects to be mapped would exceed PDO length.
0604 0043h	General parameter incompatibility reason
0604 0047h	General internal incompatibility reason in the device
0606 0000h	Access failed because of an hardware error
0607 0010h	Data type does not match, length of service parameter does not match.
0607 0012h	Data type does not match, length of service parameter exceeded.
0607 0013h	Data type does not match, length of service parameter shortfall.
0609 0011h	Sub index does not exist
0609 0030h	Value range of parameter exceeded (only for write access)
0609 0031h	Value of parameter written too high
0609 0032h	Value of parameter written too low
0609 0036h	Maximum value is less than minimum value
0800 0000h	General error
0800 0020h	Data cannot be transferred or stored to the application.

Code	Description
0800 0021h	Data cannot be transferred or stored to the application because of local control.
0800 0022h	Data cannot be transferred or stored to the application because of the present device state.
0800 0023h	Object dictionary dynamic generation fails or no object dictionary is present (e.g. object dictionary is generated from file and generation fails because of a file error).

RETVAL When the function has been executed without error, the return value contains the valid length of the response data: 1: BYTE, 2: WORD, 4: DWORD. If an error occurs during execution, the return value contains one of the following error codes.

Code	Description
F021h	Invalid slave address (call parameter equal 0 or higher 127)
F022h	Invalid transfer type (value not equal to 40h, 23h, 2Bh, 2Fh)
F023h	Invalid data length (data buffer too small, at SDO read access this should be at least 4byte, at SDO write access at least 1byte, 2byte or 4byte).
F024h	FC/SFC is not supported.
F025h	Write buffer in CANopen master overflow, service cannot be processed at this time.
F026h	Read buffer in CANopen master overflow, service cannot be processed at this time.
F027h	SDO read or write access with defective response ↪ 'CANOPENERROR' page 928.
F028h	SDO timeout (no CANopen station with this node-ID found).

BUSY As long as *BUSY* = 1, the current order is not finished.

DATABUFFER

- Data area via that the FC/SFC communicates. Set here an ANY pointer of the type Byte.
- SDO read access: Destination area for the read user data.
- SDO write access: Source area for the user data to write.



When the SDO request has been executed without errors, RETVAL contains the length of the valid response data (1, 2 or 4byte) and CANOPENERROR the value 0.

16.4.5 FC/SFC 254 - RW_SBUS - IBS communication

Description This block serves the INTERBUS-FCs 20x as communication block between INTERBUS master and CPU.

For the usage of the INTERBUS-FCs 20x the FC/SFC 254 must be included in your project as block.

Parameters

Parameter	Declaration	Type	Description
READ/WRITE	IN	Byte	0 = Read, 1 = Write
LADDR	IN	WORD	Logical Address INTERBUS master
IBS_ADDR	IN	WORD	Address INTERBUS master
DATAPointer	IN	ANY	Pointer to PLC data
RETVAL	OUT	WORD	Return value (0 = OK)

READ/WRITE

This defines the transfer direction seen from the CPU. *READ* reads the data from the Dual port memory of the INTERBUS master.

LADDR

Enter the address (**Logical Address**) from where on the register of the master is mapped in the CPU. At the start-up of the CPU, the INTERBUS master are stored in the I/O address range of the CPU following the shown formula if no hardware configuration is present:

$$\text{Start address} = 256 \times (\text{slot} - 101) + 2048$$

The slot numbers at the SPEED-Bus start with 101 at the left side of the CPU and raises from the right to the left. For example the 1. slot has the address 2048, the 2. the address 2304 etc.

IBS_ADDR

Address in the address range of the INTERBUS master.

DATAPointer

Pointer to the data area of the CPU.

RETVAL

Value that the function returns. 0 means OK.

16.5 System Function Blocks

16.5.1 SFB 7 - TIMEMESS - Time measurement

In opposite to the SFC 53, the SFB 7 returns the difference between two calls in μs . With *RESET* = 1 the current timer value is transferred to InstDB. Another call with *RESET* = 0 displays the difference in μs via *VALUE*.

Parameters

Name	Declaration	Type	Comment
RESET	IN	BOOL	<i>RESET</i> = 1 start timer
VALUE	OUT	DWORD	Difference in μs

RESET *RESET* = 1 transfers the current timer value to InstDB. Here *VALUE* is not influenced.

VALUE After a call with *RESET* = 0, *VALUE* returns the time difference between the two SFB 7 calls.

17 SSL System status list

17.1 Overview SSL

SSL

This chapter describes all the partial lists of the system status list, readable via SFC 51 RDSYSST or via Hardware configurator. SSL partial lists, which are only for internal usage, are not described here. The SSL (system status list) describes the current status of a automation system. It contains the following information:

- System data
 - These are fixed or assigned characteristics data of a CPU as configuration of the CPU, status of the priority classes and communication.
- Module status data in the CPU
 - This describes the current status of the components monitored by system diagnostic functions.
- Diagnostics data
 - The diagnostics data of modules with diagnostic capabilities assigned to the CPU.
- Diagnostics buffer
 - Diagnostic entries of the diagnostic buffer in the order in which they occur.

SSL partial list

- Only partial lists of the SSL may be accessed. The partial lists are virtual list, this means, they are only created by the operating system of the CPUs when specifically requested and may only be read.
- A partial list or a list extract may be read e.g. by means of the SFC 51 RDSYSST.
- Here with the parameters SSL_ID and INDEX you define the kind of information to read.

A partial list always has the following structure:

- Header
 - SSL-ID
 - Index
 - Length of the record set in byte
 - Number of record sets of the partial list
- Record sets
 - A record set of a partial list has a certain length, depending on the information of the partial list. It depends on the partial list as the data words are used in a record set.

SSL-ID

Structure

		SSL-ID															
		High byte								Low byte							
Bit number		15	14	13	12	11	10	9	8	7	6	5	4	3	2	1	0
	Module class: CPU: 0000 IM: 0100 FM: 1000 CP: 1100	Number of the partial list extract: Definition of the subset of the partial list								Number of the partial list: Definition of the partial list of the SSL							

17.2 Overview - SSL partial lists

SSL partial lists

- In the following all the possible SSL partial lists with additional SSL-ID are listed, which are supported by the SPEED7 system.
- SSL partial lists, which are only for internal usage, are no more described.

SSL partial list	SSL-ID
SSL Content	xy00h
Module identification	xy11h
CPU characteristics	xy12h
User memory areas	xy13h
System areas	xy14h
Block Types	xy15h
Status of all LEDs	xy19h
Identification of the component	xy1Ch
Interrupt status	xy22h
Communication status data	xy32h
Ethernet details of the module	xy37h
Status of the TCON Connections	xy3Ah
Status of the LEDs	xy74h
Status information CPU	xy91h
Stations status information (DPM)	xy92h
Stations status information (DPM, PROFINET-IO and EtherCAT)	xy94h
Module status information (PROFIBUS DP, PROFINET-IO, EtherCAT)	xy96h
Diagnostic buffer of the CPU	xyA0h
Web server diagnostic information	xy3Eh
Module diagnostic information (record set 0)	xyB1h
Module diagnostic information (record set 1) via physical address	xyB2h
Module diagnostic information (record set 1) via logical address	xyB3h
Diagnostic data of a DP slave	xyB4h
Information EtherCAT master/slave	xyE0h
EtherCAT bus system	xyE1h
Statistics information to OBs	xyFAh
Status of the VSC features from the System SLIO CPU	xyFCh

Module Identification - SSL-ID: xy11h

17.3 Module Identification - SSL-ID: xy11h

Description With the `SSL_ID` xy11h you obtain the module identification data of your module.

Header

Content	Value	Description
SSL_ID	0011h	All identification record sets
	0111h	A single identification record set
	0F11h	SSL partial list header information
INDEX	xxxxh	Selection of the identification data:
	0001h	Identification data of the module
	0006h	Identification data of the basic hardware
	0007h	Identification data of the basic firmware
	0081h	Identification data of the VIPA firmware
	0082h	Identification of the SVN version CPU
	0083h	Identification of the version CP
	6501h*	Identification of the module: CP at 1. SPEED-Bus slot (User slot = 101)
	6506h*	Identification of the basic hardware: CP at 1. SPEED-Bus slot (User slot = 101)
	6507h*	Identification of the basic firmware: CP at 1. SPEED-Bus slot (User slot = 101)
	6601h*	Identification of the module: CP at 2. SPEED-Bus slot (User slot = 102)
	6606h*	Identification of the basic hardware: CP at 2. SPEED-Bus slot (User slot = 102)
	6607h*	Identification of the basic firmware: CP at 2. SPEED-Bus slot (User slot = 102)
	6701h*	Identification of the module: CP at 3. SPEED-Bus slot (User slot = 103)
	6706h*	Identification of the basic hardware: CP at 3. SPEED-Bus slot (User slot = 103)
	6707h*	Identification of the basic firmware: CP at 3. SPEED-Bus slot (User slot = 103)
	6801h*	Identification of the module: CP at 4. SPEED-Bus slot (User slot = 104)
	6806h*	Identification of the basic hardware: CP at 4. SPEED-Bus slot (User slot = 104)
	6807h*	Identification of the basic firmware: CP at 4. SPEED-Bus slot (User slot = 104)
	6901h*	Identification of the module: CP at 5. SPEED-Bus slot (User slot = 105)
	6906h*	Identification of the basic hardware: CP at 5. SPEED-Bus slot (User slot = 105)
	6907h*	Identification of the basic firmware: CP at 5. SPEED-Bus slot (User slot = 105)
	6A01h*	Identification of the module: CP at 6. SPEED-Bus slot (User slot = 106)
	6A06h*	Identification of the basic hardware: CP at 6. SPEED-Bus slot (User slot = 106)
	6A07h*	Identification of the basic firmware: CP at 6. SPEED-Bus slot (User slot = 106)
	6B01h*	Identification of the module: CP at 7. SPEED-Bus slot (User slot = 107)
	6B06h*	Identification of the basic hardware: CP at 7. SPEED-Bus slot (User slot = 107)
	6B07h*	Identification of the basic firmware: CP at 7. SPEED-Bus slot (User slot = 107)
	6C01h*	Identification of the module: CP on 8. SPEED-Bus slot (User slot = 108)

Content	Value	Description
	6C06h*	Identification of the basic hardware: CP at 8. SPEED-Bus slot (User slot = 108)
	6C07h*	Identification of the basic firmware: CP at 8. SPEED-Bus slot (User slot = 108)
	6D01h*	Identification of the module: CP at 9. SPEED-Bus slot (User slot = 109)
	6D06h*	Identification of the basic hardware: CP at 9. SPEED-Bus slot (User slot = 109)
	6D07h*	Identification of the basic firmware: CP at 9. SPEED-Bus slot (User slot = 109)
	6E01h*	Identification of the module: CP at 10. SPEED-Bus slot (User slot = 110)
	6E06h*	Identification of the basic hardware: CP at 10. SPEED-Bus slot (User slot = 110)
	6E07h*	Identification of the basic firmware: CP at 10. SPEED-Bus slot (User slot = 110)
	CE01h*	Identification of the module: CP at CPU (User slot = 206)
	CE06h*	Identification of the basic hardware: CP at CPU (User slot = 206)
	CE07h*	Identification of the basic firmware: CP at CPU (User slot = 206)
LENTHDR	001Ch	One record set is 14words long (28bytes).
N_DR	xxxxh	Number of record sets <ul style="list-style-type: none"> ■ For <i>SSL_ID</i> 0F11h: 6 record sets (including INDEX 0082h and 0083h) ■ For <i>SSL_ID</i> 0011h: 4 record sets (without number of records 0082h)
*) This INDEX only exists in the CPUs 300S+ (up on V3.7)		

Module Identification - SSL-ID: xy11h

Record set *SSL_ID: xy11h*

CPU is not configured as Siemens 318-2AJ00

INDEX offset	Length	Description
0	1word	Number of a identification record set
2	20byte	<ul style="list-style-type: none"> ■ 0001h and 0006h: Order number (MfB) of the module; string of 19 characters and one blank (20h) e.g. 6ES7 315-2EH14 ■ 0007h: Space (20h) ■ 0081h: VIPA product name and hardware release: e.g. VIPA 015-CEFPR00-0100 ■ 0082h: Text: "SVN Revision" ■ 0083h: Text: "SVN Revision CP"
22	1word	reserved
24	1word	<ul style="list-style-type: none"> ■ 0001h and 0006h: Hardware release of the module ■ 0007h: "V" and first digit of the version ID ■ 0081h: VIPA version ID: First digit in ASCII, second digit in hex ■ 0082h: High word of "SVN revision" in hex ■ 0083h: High word of "SVN revision CP" in hex
26	1word	<ul style="list-style-type: none"> ■ 0001h and 0006h: reserved ■ 0007h: remaining digits of the version ID ■ 0081h: VIPA version ID: third and fourth digit in hex ■ 0082h: Low word of "SVN revision" in hex ■ 0083h: Low word of "SVN revision CP" in hex

CPU is configured as Siemens 318-2AJ00

INDEX offset	Length	Description
0	1word	Number of an identification record set
2	20byte	<ul style="list-style-type: none"> ■ 0001h and 0006h: Order number (MfB) of the module; string of 19 characters and one blank (20h) e.g. 6ES7 318-2AJ00-0AB0 ■ 0007h: VIPA product name and hardware release: e.g. VIPA 317-4NE23-0119
22	1word	reserved
24	1word	<ul style="list-style-type: none"> ■ 0001h and 0006h: Hardware release of the module ■ 0007h: "V" and first digit of the version ID
26	1word	<ul style="list-style-type: none"> ■ 0001h and 0006h: reserved ■ 0007h: remaining digits of the version ID

CP

INDEX offset	Length	Description
0	1word	Number of an identification record set (0x6501h ... 0xCE07h)
2	20byte	<ul style="list-style-type: none"> ■ xx01h and xx06h: Order number (MfB) of the module; string of 19 characters and one blank (20h) ■ xx07h: VIPA product name

INDEX offset	Length	Description
22	1word	reserved
24	1word	<ul style="list-style-type: none"> ■ xx01h and xx06h: Hardware release of the module ■ xx07h: "V" and first digit of the version ID
26	1word	<ul style="list-style-type: none"> ■ xx01h and xx06h: reserved ■ xx07h: remaining digits of the version ID

17.4 CPU characteristics - SSL-ID: xy12h

Description Here you can determine the hardware-specific characteristics of your CPU by specifying the appropriate feature code.

Header

Content	Wert	Description
SSL_ID	0012h	All CPU characteristics
	0112h	CPU characteristics of one group.
	0F12h	SSL partial list header information
INDEX	xxxxh	CPU characteristics of one group:
	0000h	MC7 processing unit
	0100h	Time system
	0200h	System response
	0300h	MC7 language description of the CPU
LENTHDR	0002h	One record set is 1word long (2bytes).
N_DR	xxxxh	Number of record sets

Record set

- **SSL_ID: 0012h**
 - All record sets of the CPU characteristics relevant for your CPU are listed. They follow completely one behind the other. One record set is 1word long. For each feature there is an ID. This ID is 1word long. You will find the list of the characteristics IDs on the following page.
- **SSL_ID: 0112h**
 - All data records relevant for the group are listed. They follow completely one behind the other.

Characteristics identifier

Identifier	Description
0000h - 00FFh	MC7 processing unit
0001h	MC7 processing generating code
0002h	MC7 interpreter
0100h - 01FFh	Time system

CPU characteristics - SSL-ID: xy12h

Identifier	Description
0101h	1ms resolution
0102h	10ms resolution
0103h	no real time clock
0104h	BCD time-of-day format
0105h	all time-of-day functions (set time-of-day, set and read time-of-day, time-of-day synchronization: time-of-day slave and time-of-day master)
0300h - 03FFh	MC7 language description of the CPU
0301h	reserved
0302h	all 32 bit fixed-point instructions
0303h	all floating-point instructions
0304h	sin, asin, cos, acos, tan, atan, sqr, sqrt, in, exp
0305h	ACCU3/ACCU4 with corresponding instructions (ENT, PUSH, POP, LEAVE)
0306h	Master Control Relay instructions
0307h	Address register 1 exists with corresponding instructions
0308h	Address register 2 exists with corresponding instructions
0309h	Operations for area-crossing addressing
030Ah	Operations for area-internal addressing
030Bh	all memory-indirect addressing instructions via M
030Ch	all memory-indirect addressing instructions via DB
030Dh	all memory-indirect addressing instructions via DI
030Eh	all memory-indirect addressing instructions for L
030Fh	all instructions for parameter transfer in FCs
0310h	Memory bit edge instructions via I
0311h	Memory bit edge instructions via Q
0312h	Memory bit edge instructions via M
0313h	Memory bit edge instructions via DB
0314h	Memory bit edge instructions via DI
0315h	Memory bit edge instructions via L
0316h	Dynamic evaluation of the FC bits
0317h	Dynamic local data area with the corresponding instructions

17.5 User memory areas - SSL-ID: xy13h

Description With the partial list with the *SSL_ID* xy13h you obtain information about the memory areas of the CPU.

Header

Content	Value	Description
SSL_ID	0013h	Record sets for any memory areas
	0113h	Record sets for a single memory area
	0F13h	SSL partial list header information
INDEX		Specification of a memory area (only <i>SSL_ID</i> 0113h)
	0001h	Work memory
	0002h	Load memory integrated
	0003h	Load memory plugged
	0004h	Max. plug-in load memory
	0005h	Size of backup memory
LENTHDR	0024h	One record set is 18words long (36byte).
N_DR	xxxxh	Number of record sets

Record set *SSL_ID: xy13h*

INDEX offset	Length	Description
0	1word	INDEX of a memory area <ul style="list-style-type: none"> ■ 0001h: Work memory ■ 0002h: Load memory integrated ■ 0003h: Load memory plugged ■ 0004h: max. plug-in load memory ■ 0005h: Size of backup memory
2	1word	Type of memory: <ul style="list-style-type: none"> ■ 0001h: volatile memory (RAM) ■ 0002h: non volatile memory (RAM) ■ 0003h: mixed memory (RAM and EPROM)
4	2words	Total size of the selected memory (total of area Ber1 and Ber2)
8	1word	Logical mode of the memory: <ul style="list-style-type: none"> ■ Bit 0: RAM ■ Bit 1: EPROM ■ Bit 2: RAM and EPROM For work memory: <ul style="list-style-type: none"> ■ Bit 3: Code and data separated ■ Bit 4: Code and data together
10	1word	0 (fix)

System areas - SSL-ID: xy14h

INDEX offset	Length	Description
12	2words	Size of the RAM in byte
16	2words	Size of the RAM being used
20	2words	Largest free block in the RAM <ul style="list-style-type: none"> ■ "0": no information available or cannot be determined.
24	2words	Size of the EPROM in byte
28	2words	Size of the EPROM being used
32	2words	Largest free block in the EPROM <ul style="list-style-type: none"> ■ "0": no information available or cannot be determined.

17.6 System areas - SSL-ID: xy14h

Description

If you read the partial list with *SSL_ID* xy14h, you obtain information about the system areas of the CPU.

Header

Inhalt	Wert	Description
SSL_ID	0014h	All system areas of a CPU
	0F14h	SSL partial list header information
INDEX	xxxxh	irrelevant
LENTHDR	0008h	One record set is 4words long (8byte)
N_DR	0009h	Number of record sets <ul style="list-style-type: none"> ■ You must at least assign a number of 9 record sets. ■ If you select a target area, which is too small, the SFC 51 RDSYSST does not provide a record set.

Record set *SSL_ID: xy14h*

INDEX offset	Length	Description
0	1word	INDEX of the system area <ul style="list-style-type: none"> ■ 0001h: PII (quantity in byte) ■ 0002h: PIQ (quantity in byte) ■ 0003h: Memory (number in bits) <ul style="list-style-type: none"> – This INDEX is only provided by the CPU, where the number of flags can be shown in one word. If your CPU does not provide this value, you must evaluate index 0008h ■ 0004h: Timers (quantity) ■ 0005h: Counters (quantity) ■ 0006h: Quantity of bytes in the logical address area. ■ 0007h: Local data (entire local data area of the CPU in byte) <ul style="list-style-type: none"> – This INDEX is only provided by the CPU, where the number of local data area can be shown in one word. If your CPU does not provide this value, you must evil INDEX 0009h ■ 0008h: Memory (number in bytes) ■ 0009h: Local data (entire local data area of the CPU in kbytes)
2	1word	Memory type: <ul style="list-style-type: none"> ■ 0001h: RAM ■ 0002h: EPROM
4	1word	Number of elements of the system area defined by <i>INDEX</i> .
6	1word	Number of retentive elements defined by <i>INDEX</i> .

Block types - SSL-ID: xy15h

17.7 Block types - SSL-ID: xy15h

Description You obtain the block types (OBs, DBs, SDBs, FCs and FBs) that exists on the CPU.

Header

Content	Value	Description
SSL_ID	0015h	Record sets of all block types of a CPU (Standard blocks)
	0115h	Record set of a block type of a CPU
	0815h	Record set of a block type of a CPU (VIPA specific blocks)
	0F15h	Returns the number of records and the size of the data sets for standard blocks
	8F15h	Returns the number of records and the size of the data sets for VIPA blocks
INDEX	xxxxh	irrelevant
LENTHDR	0000A	One record set is 5words long (10byte)
N_DR	xxxxh	Number of record sets

Record set *SSL_ID: 0115h*

INDEX offset	Length	Description
0	1word	Block type number: <ul style="list-style-type: none"> ■ 0800h: OB ■ 0A00h: DB ■ 0B00h: SDB ■ 0C00h: FC ■ 0E00h: FB ■ 8800h: VOB ■ 8A00h: VDB ■ 8B00h: VSDB ■ 8C00h: VFC ■ 8E00h: VFB
2	1word	Maximum number of blocks of the type: <ul style="list-style-type: none"> ■ at OBs: <ul style="list-style-type: none"> – max. possible number of OBs for a CPU ■ at DBs: <ul style="list-style-type: none"> – max. possible number of DBs including DB0 ■ at SDBs: <ul style="list-style-type: none"> – max. possible number of SDBs including SDB2 ■ at FCs and FBs: <ul style="list-style-type: none"> – max. possible number of loadable blocks
4	1word	Maximum total size of the object to be loaded in kbytes
6	2words	Maximum length of the work memory part of a block in bytes

Record set *SSL_ID: 0815h*

INDEX offset	Length	Description
0	1word	Block type number (VIPAs specific) <ul style="list-style-type: none"> ■ 8800h: VOB ■ 8A00h: VDB ■ 8B00h: VSDB ■ 8C00h: VFC ■ 8E00h: VFB
2	1word	Maximum number of blocks of the type: <ul style="list-style-type: none"> ■ at OBs: <ul style="list-style-type: none"> – max. possible number of OBs for a CPU ■ at DBs: <ul style="list-style-type: none"> – max. possible number of DBs including DB0 ■ at SDBs: <ul style="list-style-type: none"> – max. possible number of SDBs including SDB2 ■ at FCs and FBs: <ul style="list-style-type: none"> – max. possible number of loadable blocks
4	1word	Maximum total size of the object to be loaded in kbytes
6	2words	Maximum length of the work memory part of a block in bytes

Status of all LEDs - SSL-ID: xy19h

17.8 Status of all LEDs - SSL-ID: xy19h





Description You obtain information about the status of all LEDs from your CPU.

Header

Content	Value	Description
SSL_ID	0019h	Status of all LEDs (without VIPA specific)
	0119h	Status of one LED, to specify via INDEX
	0E19h	Status of all VIPA specific LEDs
	0F19h	SSL partial list header information
LENTHDR	0004h	One record set is 2words long (4byte)
N_DR	xxxxh	Number of record sets

Record set *SSL_ID: xy19h*

INDEX offset	Length	0019h	0119h	0E19h	Value	Description LED
0	1word	x	x	-	0001h	SF (Group error)
		x	x	-	0004h	RUN
		x	x	-	0005h	STOP
		x	x	-	0006h	FRCE (Force) ■ MICRO CPU: fix 0
		x	x	-	0008h	BATF (always "0") This INDEX only exists in CPUs configured as CPU 318-2AJ00. ■ SLIO CPU: fix 0 ■ MICRO CPU: fix 0
		x	x	-	000Bh	BF1: BUSF1 (Bus error interface 1) ■ 300S CPU DPM: fix 0 ■ 300S CPU PN/EC: PROFIBUS ERR LED ■ SLIO CPU PN/EC: PROFIBUS BF LED ■ MICRO CPU: -
		x	x	-	000Ch	BF2: BUSF2 (PROFINET Bus error interface 2) ■ 300S CPU DPM: PROFIBUS ERR LED ■ 300S CPU PN/EC: PROFIBUS BF LED ■ SLIO CPU PN/EC: CP BF1 LED ■ MICRO CPU: -
-	-	x	x	0013h	BF3: BUSF3 (Bus error interface 3) ■ 300S CPU: - ■ SLIO CPU: PROFINET via Ethernet PG/OP channel: virtual BF LED ■ MICRO CPU: PROFINET via Ethernet PG/OP channel: virtual BF LED (VIPA specific)	

INDEX offset	Length	0019h	0119h	0E19h	Value	Description LED
		x	x	-	0015h	MT LED <ul style="list-style-type: none"> ■ SLIO CPU: CP: MT LED ■ MICRO CPU: -
		-	x	x	0025h	MT2 LED <ul style="list-style-type: none"> ■ 300S CPU: - ■ SLIO CPU: PROFINET via Ethernet PG/OP channel: virtual MT LED ■ MICRO CPU: PROFINET via Ethernet PG/OP channel: virtual MT LED (VIPA specific)
		-	x	x	0100h	BS1 (Bus state 1) <ul style="list-style-type: none"> ■ 300S CPU: EC LED ■ SLIO CPU PN/EC: BS1 LED ■ MICRO CPU: - (VIPA specific)
		-	x	x	0101h	BS2 (Bus state Ethernet PG/OP channel) <ul style="list-style-type: none"> ■ 300S CPU: - ■ SLIO CPU: PROFINET via Ethernet PG/OP channel: virtual BS LED ■ MICRO CPU: PROFINET via Ethernet PG/OP channel: virtual BS LED (VIPA specific)
		-	x	x	1000h	Access to memory card LED <ul style="list-style-type: none"> ■ 300S CPU: MMC LED ■ SLIO CPU: SD LED ■ MICRO CPU: virtuell SD LED: blinking with 10Hz (VIPA specific)
		-	x	x	1001h	PROFIBUS Data Exchange slave LED <ul style="list-style-type: none"> ■ 300S Slave CPU: fix 0 ■ all other 300S CPUs: - ■ SLIO CPU: - ■ MICRO CPU: - (VIPA specific)
		-	x	x	1002h	MICRO: Status bar ( left green) (VIPA specific)
		-	x	x	1003h	MICRO: Status bar ( right green) (VIPA specific)
		-	x	x	1004h	MICRO: Status bar ( left red) (VIPA specific)
		-	x	x	1005h	MICRO: Status bar ( right yellow) (VIPA specific)

Status of all LEDs - SSL-ID: xy19h

INDEX offset	Length	0019h	0119h	0E19h	Value	Description LED
		-	x	x	2000h	<ul style="list-style-type: none"> ■ 300S CPU: DPM: RUN LED ■ SLIO CPU: 0 (fix) ■ MICRO CPU: - (VIPA specific)
		-	x	x	2001h	<ul style="list-style-type: none"> ■ 300S CPU: PROFIBUS: ERR LED ■ SLIO CPU: PROFIBUS: BF LED ■ MICRO CPU: - (VIPA specific)
		-	x	x	2002h	<ul style="list-style-type: none"> ■ 300S CPU: PROFIBUS: DE LED ■ SLIO CPU: PROFIBUS: DE LED ■ MICRO CPU: - (VIPA specific)
		-	x	x	2003h	<ul style="list-style-type: none"> ■ 300S CPU: DPM: IF LED ■ SLIO CPU: 0 (fix) ■ MICRO CPU: - (VIPA specific)
		-	x	x	6501h*	SF (Group error) from CP on 1. SPEED-Bus slot (User slot = 101)
		-	x	x	6504h*	RUN from CP on 1. SPEED-Bus slot (User slot = 101)
		-	x	x	6505h*	STOP from CP on 1. SPEED-Bus slot (User slot = 101)
		-	x	x	6601h*	SF (Group error) from CP on 2. SPEED-Bus slot (User slot = 102)
		-	x	x	6604h*	RUN from CP on 2. SPEED-Bus slot (User slot = 102)
		-	x	x	6605h*	STOP from CP on 2. SPEED-Bus slot (User slot = 102)
		-	x	x	6701h*	SF (Group error) from CP on 3. SPEED-Bus slot (User slot = 103)
		-	x	x	6704h*	RUN from CP on 3. SPEED-Bus slot (User slot = 103)
		-	x	x	6705h*	STOP from CP on 3. SPEED-Bus slot (User slot = 103)
		-	x	x	6801h*	SF (Group error) from CP on 4. SPEED-Bus slot (User slot = 104)
		-	x	x	6804h*	RUN vom CP from CP on 4. SPEED-Bus slot (User slot = 104)

Status of all LEDs - SSL-ID: xy19h

INDEX offset	Length	0019h	0119h	0E19h	Value	Description LED
		-	x	x	6805h*	STOP from CP on 4. SPEED-Bus slot (User slot = 104)
		-	x	x	6901h*	SF (Group error) from CP on 5. SPEED-Bus slot (User slot = 105)
		-	x	x	6904h*	RUN from CP on 5. SPEED-Bus slot (User slot = 105)
		-	x	x	6905h*	STOP from CP on 5. SPEED-Bus slot (User slot = 105)
		-	x	x	6A01h*	SF (Group error) from CP on 6. SPEED-Bus slot (User slot = 106)
		-	x	x	6A04h*	RUN from CP on 6. SPEED-Bus slot (User slot = 106)
		-	x	x	6A05h*	STOP from CP on 6. SPEED-Bus slot (User slot = 106)
		-	x	x	6B01h*	SF (Group error) from CP on 7. SPEED-Bus slot (User slot = 107)
		-	x	x	6B04h*	RUN from CP on 7. SPEED-Bus slot (User slot = 107)
		-	x	x	6B05h*	STOP from CP on 7. SPEED-Bus slot (User slot = 107)
		-	x	x	6C01h*	SF (Group error) from CP on 8. SPEED-Bus slot (User slot = 108)
		-	x	x	6C04h*	RUN from CP on 8. SPEED-Bus slot (User slot = 108)
		-	x	x	6C05h*	STOP from CP on 8. SPEED-Bus slot (User slot = 108)
		-	x	x	6D01h*	SF (Group error) from CP on 9. SPEED-Bus slot (User slot = 109)
		-	x	x	6D04h*	RUN from CP on 9. SPEED-Bus slot (User slot = 109)
		-	x	x	6D05h*	STOP from CP on 9. SPEED-Bus slot (User slot = 109)
		-	x	x	6E01h*	SF (Group error) from CP on 10. SPEED-Bus slot (User slot = 110)
		-	x	x	6E04h*	RUN from CP on 10. SPEED-Bus slot (User slot = 110)

Status of all LEDs - SSL-ID: xy19h

INDEX offset	Length	0019h	0119h	0E19h	Value	Description LED
		-	x	x	6E05h*	STOP from CP on 10. SPEED-Bus slot (User slot = 110)
		-	x	x	CE01h*	SF (Group error) from CP to CPU (User slot = 206)
		-	x	x	CE04h*	RUN from CP to CPU (User slot = 206)
		-	x	x	CE05h*	STOP from CP to CPU (User slot = 206)

*) This INDEX only exists in the CPUs 300S+ (ab V3.7)

2	1byte	1byte	1byte	1byte		Status of one LED: <ul style="list-style-type: none"> ■ 0: off ■ 1: on
---	-------	-------	-------	-------	--	---

3	1byte	1byte	1byte	1byte		Flashing status of the LED: (decimal) <ul style="list-style-type: none"> ■ 0: off ■ 1: flashing normally (2Hz) ■ 2: flashing slowly (0.5Hz) ■ Note: EtherCat systemic flashing frequency 1Hz ■ 3: flashing with 1Hz (VIPA specific) ■ 4: flashing with 4Hz (VIPA specific) ■ 5: flashing with 2.5Hz (VIPA specific) ■ 6: flashing with 10Hz (VIPA specific) ■ 7: cyclically: short (200 ms) flashes once then off for 1000ms. (VIPA specific) ■ 8: cyclical: flashes twice briefly (200ms) then off for 1000ms. (VIPA specific) ■ 9: cyclically: three short flashes (200ms) then off for 1000ms. (VIPA specific) ■ 10: cyclical: remains 4 seconds, then 2 seconds off. (VIPA specific) ■ 11: flashes with 1.5Hz. (VIPA specific) ■ 12: flashes alternately with 1Hz with a second LED. (VIPA specific) ■ 13: flashes with 10Hz for 500ms, then off for 500ms. (VIPA specific)
---	-------	-------	-------	-------	--	--

*) This INDEX only exists in the CPUs 300S+ (ab V3.7)

17.9 Identification of the component - SSL-ID: xy1Ch

Description If you read the partial list you can identify the CPU or the automation system.

Header

Content	Value	Description
SSL_ID	001Ch	Identification of all components
	011Ch	Identification of one component
	0F1Ch	SSL partial list header information
INDEX	0001h	Name of the automation system
	0002h	Name of the module
	0003h	Plant identification of the module
	0005h	Serial number of the module
	0006h	Reserved for the operating system
	0007h	Module type name
	0008h	Serial number of the memory card - CID without CardType
	000Ah	OEM identification of the module
	000Bh	Location identifier of the module
	00E0h	Serial number at the key file in the activated memory card (only at SSL_ID 011Ch)
	00E1h	Serial number at the key file in the plugged memory card (only at SSL_ID 011Ch)
	00FFh	Serial number of the memory card - CID with CardType (only at SSL_ID 011Ch)
LENTHDR	xxxxh	<ul style="list-style-type: none"> ■ INDEX < 00E0h <ul style="list-style-type: none"> – A record set is 17words long (34byte) ■ INDEX = 00E0h, 00E1h <ul style="list-style-type: none"> – A record set is 5words long (10byte) ■ INDEX = 00FFh <ul style="list-style-type: none"> – A record set is 19words long (38byte)
N_DR		Number of record sets
	0009h	at SSL_ID: 001Ch
	0001h	at SSL_ID: 011Ch

Record set

SSL_ID: xy1Ch INDEX: 0001h

INDEX offset	Length	Description
0	1word	INDEX SSL_ID: 011C: Identifier of the component: 0001h
2	12words	Name of the automation system (max. 24 characters)*
26	4words	reserved

*) If names and designations are shorter than the corresponding max. characters, the gaps are filled with 00h.

Identification of the component - SSL-ID: xy1Ch

SSL_ID: xy1Ch INDEX: 0002h

INDEX offset	Length	Description
0	1word	INDEX SSL_ID: 011C: Identifier of the component: 0002h
2	12words	Name of the module (max. 24 characters)*
26	4words	reserved

*) If names and designations are shorter than the corresponding max. characters, the gaps are filled with 00h.

SSL_ID: xy1Ch INDEX: 0003h

INDEX offset	Length	Description
0	1word	INDEX SSL_ID: 011C: Identifier of the component: 0003h
2	16words	Plant identification of the module (max. 32 characters)*

*) If names and designations are shorter than the corresponding max. characters, the gaps are filled with 00h.

SSL_ID: xy1Ch INDEX: 0005h

INDEX offset	Length	Description
0	1word	INDEX SSL_ID: 011C: Identifier of the component: 0005h
2	12words	Serial number of the module (max. 24 characters)*
26	4words	reserved

*) If names and designations are shorter than the corresponding max. characters, the gaps are filled with 00h.

SSL_ID: xy1Ch INDEX: 0007h

INDEX offset	Length	Description
0	1word	INDEX SSL_ID: 011C: Identifier of the component: 0007h
2	16words	Module type name as character string (max. 32 characters)*

*) If names and designations are shorter than the corresponding max. characters, the gaps are filled with 00h.

SSL_ID: xy1Ch INDEX: 0008h

INDEX offset	Length	Description
0	1words	INDEX SSL_ID: 011C: Identifier of the component: 0008h
2	16words	Serial number of the memory card CID without CardType: (max. 32 characters)*

Identification of the component - SSL-ID: xy1Ch

INDEX offset	Length	Description
		<ul style="list-style-type: none"> ■ CID without CardType: <ul style="list-style-type: none"> – at MMC card: "MMC " + serial number – at SD card: "SD " + serial number (Product serial number from CID) – if no card is plugged: 0
*) If names and designations are shorter than the corresponding max. characters, the gaps are filled with 00h.		

SSL_ID: xy1Ch INDEX: 000Ah

INDEX offset	Length	Description
0	1word	INDEX SSL_ID: 011C: Identifier of the component: 000Ah
2	13words	OEM identification of the module (max. 20 characters)*
28	3words	reserved
*) If names and designations are shorter than the corresponding max. characters, the gaps are filled with 00h.		

SSL_ID: xy1Ch INDEX: 000Bh

INDEX offset	Length	Description
0	1word	INDEX SSL_ID: 011C: Identifier of the component: 000Bh
2	16words	Location identifier of the module (max. 32 characters)*
*) If names and designations are shorter than the corresponding max. characters, the gaps are filled with 00h.		

SSL_ID: xy1Ch INDEX: 00E0h

INDEX offset	Length	Description
0	1word	INDEX SSL_ID: 011C: Identifier of the component: 000Bh
2	5words	Serial number at the key file in the activated memory card (only at SSL_ID x11Ch)*
*) If names and designations are shorter than the corresponding max. characters, the gaps are filled with 00h.		

SSL_ID: xy1Ch INDEX: 00E1h

INDEX offset	Length	Description
0	1word	INDEX SSL_ID: 011C: Identifier of the component: 00E1h
2	5words	Serial number at the key file in the plugged memory card (only at SSL_ID x11Ch)*
*) If names and designations are shorter than the corresponding max. characters, the gaps are filled with 00h.		

Interrupt status - SSL-ID: xy22h

SSL_ID: xy1Ch INDEX: 00FFh

INDEX offset	Length	Description
		Serial number of the memory card (only at SSL_ID x11Ch)
0	2words	Manufacturer ID
4	2words	Application ID
8	4words	Product Name
16	2words	Product Revision
20	2words	Product Serial Number
24	2words	Manufacturer Month
28	2words	Manufacturer Year
32	2words	Card Type: <ul style="list-style-type: none"> ■ 0 = MMC ■ 1 = SD ■ 2 = SDHC

If names and designations are shorter than the corresponding max. characters, the gaps are filled with 00h.

17.10 Interrupt status - SSL-ID: xy22h**Description**

This partial list contains information about the current status of interrupt processing and interrupt generation in the module.

Header

Content	Value	Description
SSL_ID	0222h	Status information on the alarm OBs The interrupt class is to be specified via INDEX
INDEX	0001h	OB 1 (Free cycle)
	000Ah	OB 10 (Time-of-day interrupt)
	000Bh	OB 11 (Time-of-day interrupt)
	0014h	OB 20 (Time-delay interrupt)
	0015h	OB 21 (Time-delay interrupt)
	001Ch	OB 28 (VIPA Watchdog Interrupt)
	001Dh	OB 29 (VIPA Watchdog Interrupt)
	0020h	OB 32 (Watchdog Interrupt)
	0021h	OB 33 (Watchdog Interrupt)
	0022h	OB 34 (Watchdog Interrupt)
	0023h	OB 35 (Watchdog Interrupt)
	0028h	OB 40 (Hardware Interrupt)
	0029h	OB 41 (Hardware Interrupt)

Content	Value	Description
	0037h	OB 55 (Status Interrupt)
	0038h	OB 56 (Update Interrupt)
	0039h	OB 57 (Manufacturer Specific Interrupt)
	003Dh	OB 61 (Clock synchronous error)
	0050h	OB 80 (Asynchronous error)
	0051h	OB 81 (Asynchronous error)
	0052h	OB 82 (Asynchronous error)
	0053h	OB 83 (Asynchronous error)
	0055h	OB 85 (Asynchronous error)
	0056h	OB 86 (Asynchronous error)
	0057h	OB 87 (Asynchronous error)
	0064h	OB 100 (Reboot)
	0066h	OB 102 (Reboot)
	0079h	OB 121 (Synchronous error)
	007Ah	OB 122 (Synchronous error)
LENTHDR	001Ch	A record set is 14words long (28bytes)
N_DR	0001h	Number of record sets (here always 1)

Interrupt status - SSL-ID: xy22h

Record set *SSL_ID: xy22h*

INDEX offset	Length	Description
0	10words	<p>Start info for the given OB, with following exceptions:</p> <ul style="list-style-type: none"> ■ OB 1 provides the current minimum (in bytes 8 and 9) and maximum cycle time (in bytes 10 and 11) (time base: ms, byte count begins at 0). ■ When a job is active for a time-delay interrupt, bytes 8 ... 11 (byte count begins at) get the remaining time in ms left of the delay time set as a parameter. ■ OB 80 contains the configured minimum (in bytes 8 and 9) and maximum cycle time (in bytes 10 and 11) (time base: ms, byte count begins at 0). ■ Error interrupts without the current information. ■ Interrupts contain the status info from the current parameter settings of the interrupt source. ■ In the case of synchronous errors, the priority class entered is 7Fh if the OBs were not yet processed; otherwise, the priority class of the last call. ■ If an OB has several start events and these have not yet occurred at the information time, then event no. xyzzh is returned with: x: event class y: undefined zz: smallest defined number in the group Otherwise, the number of the last start event that occurred is used.
20	1word	<p>Processing identifiers:</p> <ul style="list-style-type: none"> ■ Bit 0: Interrupt event is caused by parameters: <ul style="list-style-type: none"> – 0: enabled – 1: disabled ■ Bit 1: Interrupt event as per SFC 39 DIS_IRT <ul style="list-style-type: none"> – 0: not locked – 1: locked ■ Bit 2: generation job ready for time interrupts, time-of-day/time-delay interrupt OB started, cyclic interrupt OB was configured <ul style="list-style-type: none"> – 0: Interrupt source is not active – 1: Interrupt source is active ■ Bit 3: reserved ■ Bit 4: Interrupt OB <ul style="list-style-type: none"> – 0: is not loaded – 1: is loaded ■ Bit 5: Interrupt OB is by TIS: <ul style="list-style-type: none"> – 0: enabled – 1: disabled ■ Bit 6: Entry in diagnostic buffer <ul style="list-style-type: none"> – 0: enabled – 1: disabled ■ Bit 15 ... 7: reserved

INDEX offset	Length	Description
22	1word	Reaction with not loaded/locked OB <ul style="list-style-type: none"> ■ Bit 0: 1: Lock interrupt source ■ Bit 1: 1: Generate interrupt event error ■ Bit 2: 1: CPU goes into STOP mode ■ Bit 3: 1: Interrupt only discarded ■ Bit 15 ... 4: reserved
24	2words	Discard by TIS functions <ul style="list-style-type: none"> ■ Bit number x set means: <ul style="list-style-type: none"> – The event number that is larger than the smallest event to x the according event number is discard by TIS function.

Record set**SSL_ID: 0222h INDEX: 003Dh**

The data set contains the local data of OB 61 and further information on the status to the OB 61.

INDEX offset	Length	Description
0	1byte	<ul style="list-style-type: none"> ■ Event class and identifiers: <ul style="list-style-type: none"> – 11h: Alarm is active
1	1byte	64h: Start request for OB 61
2	1byte	Assigned priority class; Default value: 25
3	1byte	OB number: 61 ... 64
4	1byte	reserved
5	1byte	reserved
6	1bit	OB61_GC_VIOL: GC violation at PROFIBUS DP
6	1bit	OB61_FIRST: First run after start up or stop state
7	1byte	Number of failed OB 61 starts since the last OB 61 execution
8	1byte	PROFINET-IO system ID of the clock synchronous PN IO system (100 ... 115)
9	1byte	reserved
10	2bytes	reserved
12	8bytes	Date and time of day when the OB was called
20	2bytes	Processing identifiers (see below)
22	2bytes	Reaction with not loaded/locked OB (see below)
24	4bytes	Discard by TIS functions (see below)

Interrupt status - SSL-ID: xy22h

Additional status information OB 61

INDEX offset	Length	Description
0	2 Bytes	<p>Processing identifiers</p> <ul style="list-style-type: none"> ■ Bit 0: Interrupt event is caused by parameters: <ul style="list-style-type: none"> – 0: enabled – 1: disabled ■ Bit 1: Interrupt event as per SFC 39 DIS_IRT: <ul style="list-style-type: none"> – 0: not locked – 1: locked ■ Bit 2: <p>(Generation job ready for time interrupts, time-of-day/time-delay interrupt OB started, cyclic interrupt OB was configured)</p> <ul style="list-style-type: none"> – 0 = not active – 1 = Interrupt source is active ■ Bit 4: Interrupt OB: <ul style="list-style-type: none"> – 0: is not loaded – 1: is loaded ■ Bit 5: Interrupt OB is by TIS: <ul style="list-style-type: none"> – 0: enabled – 1: disabled ■ Bit 6: Entry in diagnostic buffer: <ul style="list-style-type: none"> – 0: enabled – 1: disabled ■ Bit 15 ... 7: reserved
2	2 Bytes	<p>Reaction with not loaded / locked OB</p> <ul style="list-style-type: none"> ■ Bit 0: 1: Lock interrupt source ■ Bit 1: 1: Generate interrupt event error ■ Bit 2: 1: CPU goes into STOP mode ■ Bit 3: 1: Interrupt only discarded ■ Bit 15 ... 4: reserved
4	4 Bytes	<p>Discard by TIS functions</p> <ul style="list-style-type: none"> ■ Bit number x set means: <ul style="list-style-type: none"> – The event number that is larger than the smallest event to x the according event number is discard by TIS function.

17.11 Communication status data - SSL-ID: xy32h

Description If you read this partial list you obtain the status data of the CPU communication section.

Header

Content	Value	Description
SSL_ID	0132h	Reading the diagnostic information
	0F32h	SSL partial list header information
INDEX	0001h	General of communication status data.
	0002h	TIS status data
	0004h	Protection status data
	0006h	Data exchange via communication SFB
	0008h	Time system (16bit Run-time meter 0 ... 7)
	0009h	MPI status data
	000Ah	K-Bus status data
	000Bh	Time system (32bit Run-time meter 0 ... 7)
	LENTHDR	0028h
The assignment depends on the INDEX parameter		
N_DR	xxxxh	Number of record sets

Record set

SSL_ID: 0132h INDEX: 0001h

The partial list extract contains information about general of communication status data.

INDEX offset	Length	Description
0	1word	General condition data for communication
2	1word	Reserved number of PG connections (Default = 1)
4	1word	Reserved Number of OP connections (Default = 1)
6	1word	Number of occupied PG connections
8	1word	Number of occupied OP connections
10	1word	Number of configured S7 connections (Default = 0)
12	1word	Number of occupied S7 connections
14	1word	Number of unused connection resources
16	1word	reserved
18	1word	Max. preset communication load of the CPU in % (Default = 20%)
20	7words	reserved (0000h)
34	1byte	Reserved number S7 basic communication connections (Default = 0)
35	1byte	Number of occupied S7 basic communication connections (XPut/XGet/MPI)

Communication status data - SSL-ID: xy32h

INDEX offset	Length	Description
36	1word	Number of occupied other connections
38	1word	Dialog mode switching (communication dialog) via Siemens SIMATIC Manager: <ul style="list-style-type: none"> ■ 0000h: communication dialog <ul style="list-style-type: none"> – Siemens CPU 318 – VIPA CPU 317-4NE12 ■ 0001h: communication dialog <ul style="list-style-type: none"> – CPU 315-2AG10 – CPU 317-2AJ10 ■ 0002h: reserved ■ 0003h: communication dialog <ul style="list-style-type: none"> – Siemens CPU 315-2EH13 FW: V2.6 – Siemens CPU 317-4EK14 FW: V3.x

Record set

SSL_ID: 0132h INDEX: 0002h

The partial list extract contains information about the TIS status data.

INDEX offset	Length	Description
0	1word	0002h: TIS status
2	1word	Number of furnished TIS orders
4	18words	reserved

Record set

SSL_ID: 0132h INDEX: 0004h

The partial list extract contains information about protection status data.

INDEX offset	Length	Description
0	1word	0004h: Protection status
2	1word	Protection at the key switch (possible value : 1, 2 or 3)
4	1word	<ul style="list-style-type: none"> ■ Configured protection level (possible values: 0, 1, 2 or 3) <ul style="list-style-type: none"> – 0: no password, parameterized protection level is invalid)
6	1word	<ul style="list-style-type: none"> ■ Valid protection level of the CPU <ul style="list-style-type: none"> – (possible values: 1, 2 or 3)
8	1word	Position of the mode switch: <ul style="list-style-type: none"> ■ 0: undefined or can not be determined ■ 1: RUN ■ 2: RUN_P ■ 3: STOP ■ 4: MRES

INDEX offset	Length	Description
10	1word	Position of the mode CRST/WRST: <ul style="list-style-type: none"> ■ 0: undefined or can not be determined ■ 1: CRST (Cold Restart) ■ 2: WRST (Warm Restart)
12	1word	reserved
14	1word	ID for the validity of the following four checksums (0: invalid)
16	1word	Checksum 1 of the hardware configuration (Intel format): Exclusive OR operation over the lengths of all system data blocks
18	1word	Checksum 2 of the hardware configuration (Intel format): Exclusive OR operation over the lengths of all system data blocks
20	1word	Checksum 1 of the user program (Intel format): Exclusive OR operation over the lengths of the following blocks: OBs, DBs, FBs, FCs
22	1word	Checksum 2 of the user program (Intel format): Exclusive OR operation over the lengths of the following blocks: OBs, DBs, FBs, FCs
24	8words	reserved

Record set**SSL_ID: 0132h INDEX: 0006h**

The partial list extract contains information about data exchange via communication SFB of configured connections.

INDEX offset	Length	Description
0	1word	0006h: Data exchange via communication SFB of configured connections
2	1words	Used SFB blocks
10	1byte	reserved
11	1word	Number of loaded SFB instances
13	1word	Number of multicast used blocks
15	25byte	reserved

Record set**SSL_ID: 0132h INDEX 0008h**

The partial list extract contains information about the status of the 16bit run-time meter 0 ... 7.

INDEX offset	Length	Description
0	1word	0008h: Time system status
2	1word	Cycle time of the synchronization telegram
4	1word	Correction factor for the time

Communication status data - SSL-ID: xy32h

INDEX offset	Length	Description
6	1word	Run-time meter 0: time in hours
8	1word	Run-time meter 1: time in hours
10	1word	Run-time meter 2: time in hours
12	1word	Run-time meter 3: time in hours
14	1word	Run-time meter 4: time in hours
16	1word	Run-time meter 5: time in hours
18	1word	Run-time meter 6: time in hours
20	1word	Run-time meter 7: time in hours
22	4words	Current date and time (format: Date_and_Time)
30	1byte	<ul style="list-style-type: none"> ■ Bit x: Run-time meter x with $0 \leq x \leq 7$ – 1: Run-time meter active
31	1byte	reserved
32	1byte	<ul style="list-style-type: none"> ■ Bit x: Run-time meter overflow x with $0 \leq x \leq 7$ – 1: overflow
33	1byte	reserved
34	3words	reserved

Time status

Status	Time status															
	High byte								Low byte							
Bit number	15	14	13	12	11	10	9	8	7	6	5	4	3	2	1	0
	SG	correction value					-	-	hr	su/wi	-	res		-	-	sync

Status

Bit	Description	Default value
0	<p>Synchronization failure</p> <p>This parameter indicates whether the time transmitted in the frame from an external time master is synchronized.</p> <ul style="list-style-type: none"> ■ 0: synchronization failed ■ 1: synchronization occurred <p>Note:</p> <p>Evaluation of this bit in a CPU is only useful if there is continuous external time synchronization.</p>	0
1	Parameter is not used.	0
2	Parameter is not used.	0

Bit	Description	Default value
4, 3	Time resolution <ul style="list-style-type: none"> ■ 00: 0.001s ■ 01: 0.01s ■ 10: 0.1s ■ 11: 1s 	00
5	Parameter is not used.	0
6	Summer/winter time indicator The parameter indicates whether the local time calculated using the correction value is summer or winter time. <ul style="list-style-type: none"> ■ 0: winter time ■ 1: summer time 	0
7	Notification hour This parameter indicates whether the next time adjustment also includes a switch over from summer to winter time or vice versa. <ul style="list-style-type: none"> ■ 0: no adjustment made ■ 1: adjustment made 	0
8	reserved	0
9	reserved	0
14 ... 10	Correction value (Local time = basic time ± correction value * 0.5h) This correction takes into account the time zone and the time difference.	00000
15	Sign for the correction value <ul style="list-style-type: none"> ■ 0: positive ■ 1: negative 	0

Record set**SSL_ID: 0132h INDEX: 0009h**

The partial list extract contains information about the status data of the MPI.

INDEX offset	Length	Description
0	1word	0009h: MPI status data
2	1words	Used Baud rate (hexadecimal code)
4	17words	reserved

Communication status data - SSL-ID: xy32h

Record set *SSL_ID: 0132h INDEX: 000Ah*

The partial list extract contains information about the status data of the K bus.

INDEX offset	Length	Description
0	1word	000Ah: K bus status data
2	2words	Used baud rate (hexadecimal code)
4	17words	reserved

Record set *SSL_ID: 0132h INDEX: 000Bh*

The partial list extract contains information about the status of the 32bit run-time meter 0 ... 7.

INDEX offset	Length	Description
0	1word	000Bh: Time system status
2	1byte	<ul style="list-style-type: none"> ■ Bit x: Run-time meter x with $0 \leq x \leq 7$ – 1: Run-time meter active
3	1byte	reserved
4	1byte	<ul style="list-style-type: none"> ■ Bit x: Run-time meter overflow x with $0 \leq x \leq 7$ – 1: overflow
5	1byte	reserved
6	1Dword	Run-time meter 0: time in hours
10	1Dword	Run-time meter 1: time in hours
14	1Dword	Run-time meter 2: time in hours
18	1Dword	Run-time meter 3: time in hours
22	1Dword	Run-time meter 4: time in hours
26	1Dword	Run-time meter 5: time in hours
30	1Dword	Run-time meter 6: time in hours
34	1Dword	Run-time meter 7: time in hours
38	1word	reserved

17.12 Ethernet details of the module - SSL-ID xy37h

Description

With this partial list you get information about the configuration of the TCP/IP stack, the vendor specified MAC address and the connection properties on layer 2 - security layer (data link layer) of the CP interface.



Information about the Ethernet PG/OP channel

- With CPUs with integrated CP PROFINET or EtherCAT, two data sets are supplied. In the 1. record set you will find the information of the CP and in the 2. record set information of the Ethernet PG/OP channel.
- One record set is provided for CPUs without a CP. In this you will find the information of the Ethernet PG/OP channel.
- If an interface is not configured, the value 2000h is supplied in logaddr. This is also the case for the Ethernet PG/OP channel, for example, if a CP 343-1EX11, 343-1EX21 or 343-1EX30 is configured, but the Ethernet interface is not networked. Here the SSL-ID: 0137h provides no record set.

Header

Content	Value	Description
SSL_ID	0037h	Details of all Ethernet interfaces
	0137h	Details of an Ethernet interface
	0F37h	SSL partial list header information
INDEX	0000h	if the details of all Ethernet interfaces are requested
		Logical base address of the Ethernet interface, which details are requested
LENTHDR	0030h	One record set is 24words long (48bytes)
N_DR	xxxxh	Number of record sets

Ethernet details of the module - SSL-ID xy37h

Record set

SSL_ID: xy37h

INDEX offset	Name	Length	Description
0	logaddr	2byte	Logical base address of the interface
2	ip_addr	4byte	IP address The IP address is stored in the following format (at the example a.b.c.d): <ul style="list-style-type: none"> ■ Offset x: a, ■ Offset x+1: b, ■ Offset x+2: c, ■ Offset x+3: d
6	subnetmask	4byte	subnet mask The subnet mask is stored in the following format (at the example a.b.c.d): <ul style="list-style-type: none"> ■ Offset x: a, ■ Offset x+1: b, ■ Offset x+2: c, ■ Offset x+3: d
10	defaultrouter	4byte	IP address of the default router <ul style="list-style-type: none"> ■ If you have not configured a default router, here the IP address of the interface is entered.
14	mac_addr	6byte	MAC address
20	source	1byte	Origin of the IP address: <ul style="list-style-type: none"> ■ 00h: IP address is not initialized ■ 01h: IP address was configured ■ 02h: IP address was set by DCP ■ 03h: IP address comes from a DHCP server ■ 04h ... FFh: reserved
21	reserved	1byte	reserved
22	dcp_mod_timestamp	8byte	Time stamp of the last change of the IP address via DCP Note: The content of this field may be evaluated only when bit 1 is set in <i>source</i> .

INDEX offset	Name	Length	Description
30	phys_mode1	1byte	<p>State of port 1:</p> <ul style="list-style-type: none"> ■ Bit 0: Duplex mode (only relevant if AUI-Mode = 0): <ul style="list-style-type: none"> – 1: phys. Layer works full duplex – 0: phys. Layer works half duplex ■ Bit 1: Baud rate ID (only relevant if AUI-Mode = 0): <ul style="list-style-type: none"> – 1: phys. Layer works with 100MBaud – 0: phys. Layer works with 10MBaud ■ Bit 2: Link status: <ul style="list-style-type: none"> – 1: phys. Layer has link pulses – 0: phys. Layer has no link pulses ■ Bit 3: Auto mode: <ul style="list-style-type: none"> – 1: phys. Layer has to automatically adjust to the LAN medium – 0: phys. Layer will not automatically adjust to the LAN medium ■ Bit 6 ... 4: 0 ■ Bit 7: Validity: <ul style="list-style-type: none"> – 0: phys_mode1 has no valid data – 1: phys_mode1 has valid data <p>The numbering of the ports is identical to the numbering in the configuration. If the interface has only one port, whose physical properties are entered at port 1.</p>
31	phys_mode2	1byte	State of port 2 (structure like phys_mode1)
...
45	phys_mode16	1byte	State of port 16 (structure like phys_mode1)
46	reserved	2byte	reserved



If you have not carried out any IP configuration, the variables ip_addr, subnetmask and defaultrouter each have the value zero.

TCON Connection - SSL-ID: xy3Ah

17.13 TCON Connection - SSL-ID: xy3Ah

Description

If you read this partial list, you obtain information of the TCON connection from qualified CPUs.

The "Open Communication via Industrial Ethernet" in the Siemens SIMATIC Manager dialog is visible only when the SSL 003Ah and 0F3Ah exist and are available. For this, you must be entered in the table of contents (SSL 0000h).

The diagnostic data that can be read by the SSL, will be updated by the system with a period of one second.

Header

Content	Value	Description
SSL_ID	003Ah	Read diagnostic information
	0F3Ah	SSL partial list header information
INDEX		Status TCON connection
LENTHDR	0094h	Length of following record set is 74words (148byte)
N_DR	000xh	<ul style="list-style-type: none"> ■ 0: TCON Online Diagnostics is not possible ("Diagnostics" button in the Siemens SIMATIC Manager = "gray"). It is delivered only the header and no further user data. ■ >0: TCON Online Diagnosis enabled

Record set

SSL_ID: xy3Ah INDEX: 003Ah

If you read this partial list, you obtain information of the TCON connection from qualified CPUs.

INDEX offset	Length	Description
0	1word	0100h: unknown
2	1word	"current connection number": not connection ID
4	1word	Block_length ³ 40h: Up to Offset 4 ... 67 = 64 byte
6	1word	ID ³ : connection ID
8	1byte	<ul style="list-style-type: none"> ■ connection_type³: <ul style="list-style-type: none"> – 11h = TCP/IP – 12h = ISO on TCP – 13h = UDP – 01h = TCP (compatibility mode)
9	1byte	active_est ³
10	1byte	local_device_id ³ 02h: CPU Type
11	1byte	local_tsap_id_len ³
12	1byte	rem_subnet_id_len ³
13	1byte	rem_staddr_len ³ 04h: für IP-Adresse

INDEX offset	Length	Description
14	1byte	rem_tsap_id_len ³
15	1byte	next_staddr_len ³
16	16byte	local_tsap_id (include TSAP or Port number) ³
32	6byte	rem_subnet_id ³ for routing
38	6byte	rem_staddr (remote IP address) ³
44	16byte	rem_tsap_id (include TSAP or Port number) ³
60	6byte	next_staddr (next IP address) ³ for routing
66	1word	spare ³
68	4byte	local_staddr (local IP address) ³
72	8byte	1. timestamp ¹ timestamp for 1. call attempt
80	8byte	2. timestamp ¹ Storage for timestamp 4 at disconnection
88	8byte	3. timestamp ¹ Timestamp, the error message of the last disconnection In this purpose there is an error number (Offset: 132)
96	8byte	4. timestamp ¹ Timestamp for successful connection Is copied in disconnection by timestamp 2 and deleted (reset all to 0)
104	8byte	5. timestamp ¹ Timestamp of the last failed connection attempt In this purpose there is an error number (Offset: 130)
112	4byte	rem_ip_addr (remote IP address) ⁴
116	2byte	rem_port_nr (remote Port number) ⁴
118	2byte	spare ⁴
120	4byte	rem_ip_addr (remote IP address) ⁵
124	2byte	rem_port_nr (remote Port number) ⁵
126	2byte	spare ⁵
128	1word	<ul style="list-style-type: none"> ■ State of connection: <ul style="list-style-type: none"> – 0000h: no display – 0001h: Connection is established – 0002h: no display – 0003h: Connection is established passive – 0004h: Connection is established active – 0005h: Connection is established passive – > 0005h: no display

TCON Connection - SSL-ID: xy3Ah

INDEX offset	Length	Description
130	1word	<ul style="list-style-type: none"> ■ Error message of the last connection attempt: <ul style="list-style-type: none"> – 0000h: no error – 0001h: local network error – 0002h: participant not available – 0003h: local abort – 0004h: abort by partner – 0005h: abort due to timeout – 0006h: abort by protocol error – 0007h: system internal error (7) – 0008h: system internal error (8) – 0009h: system internal error (9) – 000Ah: system internal error (10) – 000Bh: call attempt to own station address – 000Ch: double addressing – ≥ 000Dh: unknown error
132	1word	<ul style="list-style-type: none"> ■ – Error message from the last disconnection: <ul style="list-style-type: none"> – 0000h: no error – 0001h: local network error – 0002h: participant not available – 0003h: local abort – 0004h: abort by partner – 0005h: abort due to timeout – 0006h: abort by protocol error – 0007h: system internal error (7) – 0008h: system internal error (8) – 0009h: system internal error (9) – 000Ah: system internal error (10) – 000Bh: Call attempt to own station address – 000Ch: double addressing – ≥ 000Dh: unknown error
134	1word	Current connection attempts; is reset when connected
136	1Dword	Number of bytes sent
140	1Dword	Number of bytes received
144	1word	Number of successful connection attempts
146	1word	0000h: unknown

1) Time stamp (data type: S7 Date and Time), resolution in seconds, milliseconds are zeroed

3) Fields corresponding TCON Config DB (UDT65). Fields rem_staddr_len, rem_tsap_id_len, rem_staddr and rem_tsap_id updated when connected with address data of the communication partner

4) Fields according to the address of DB TUSEND (UDT66)

5) Fields according to the address of DB TURCV by calling (UDT66)

17.14 WebVisu diagnostic information - SSL-ID: xy3Eh

Description This partial list contains information about the diagnostic information of the WebVisu.

Header

Content	Value	Description
SSL_ID	003Eh	Record sets of all the WebVisu
	013Eh	Single record set: Selection by constant in INDEX
	113Eh	Single record set: Selection via logical address of the interface in INDEX
	0F3Eh	SSL partial list header information
INDEX	xxxxh	<ul style="list-style-type: none"> ■ SSL_ID = 013Eh: <ul style="list-style-type: none"> – 0000h: reserved – 0001h: WebVisu CPU – 0002h: WebVisu CP ■ SSL_ID = 113Eh: <ul style="list-style-type: none"> – logical address of the Ethernet interface ■ otherwise: 0000h
LENTHDR	000Eh	A record is 13word (26byte).
N_DR	xxxxh	Number of record sets

Record set

SSL_ID: xy3Eh

INDEX offset	Length	Description
0	1word	Version of the supported WebVisu API: <ul style="list-style-type: none"> ■ MSB = Major ■ LSB = Minor
2	1word	Status codes of the WebVisu ↪ <i>'Status codes of the WebVisu' page 970</i>
4	1word	Configured port number of the WebVisu; 0000h: WebVisu not active.
6	1word	Configured port number of the HTTPS WebVisu; 0000h: WebVisu not active.
8	1byte	Number of active sessions.
9	1byte	Maximum number of parallel sessions.
10	1word	Number of variables that are used at least once.
12	1word	Maximum number of variables used.
14	1word	Number of large variables (strings) used.
16	1word	Number of large variables (strings) used.
18	1word	WebVisu project size in kbyte.
20	1word	Maximum WebVisu project size in kbyte.
22	1DWord	Configured features ↪ <i>'Feature code' page 971</i>

WebVisu diagnostic information - SSL-ID: xy3Eh

Status codes of the WebVisu

- *Status information*
 - Here you get information about the states of the WebVisu, which are not error or start-up obstacles and do not require any action.
- *Start-up obstacles*
 - *Start-up obstacle* represent the error-free STOP states of the WebVisu. They provide information about the preconditions, which are not met at start-up the WebVisu.
- *Errors*
 - *Errors* indicate STOP states due to an error. These are e.g. internal software errors, errors when reading the project files and errors in the configuration of the WebVisu.

Area	Description
0x0000 - 0x0FFF	Status information
0x1000 - 0x1FFF	Start-up obstacle (no mistakes)
0x2000 - 0xDFFF	reserved
0xE000 - 0xFFFF	Error

Status code	Description
0x0000	<i>WebVisu</i> is active / has started-up and can be opened.
0x0001	Loading <i>WebVisu</i> project.
0x0002	<i>WebVisu</i> server shuts down.
0x0003	<i>WebVisu</i> STOP requested.
0x0004	<i>WebVisu</i> server is down.
0x1000	<i>WebVisu</i> is not enabled, external memory card (VSD or VSC) is missing.
0x1001	<i>WebVisu</i> was disabled by the user.
0x1002	No <i>WebVisu</i> project available.
0x1003	No hardware configuration is loaded in the CPU.
0x1004	Invalid <i>WebVisu</i> configuration.
0xE000	Error initializing the file system.
0xE100	Error loading <i>WebVisu</i> project, project file too large.
0xE101	Failed to load the <i>WebVisu</i> project, project file may be corrupt.
0xE102	Failed to delete the <i>WebVisu</i> project.
0xE103	<i>WebVisu</i> project to delete was not found in the memory.
0xE104	CRC of the <i>WebVisu</i> project file is not correct.
0xE200	<i>WebVisu</i> server has terminated unexpectedly.
0xE201	Internal error - initialization failed step 1.
0xE202	Internal error - initialization failed step 2.
0xFFFF	Unexpected internal error.

Feature code

Bit	Description
0	1: HTTP enabled
1	1: HTTPS enabled
2	1: Password protection activated
3 ... 31	reserved

Status of the LEDs - SSL-ID: xy74h

17.15 Status of the LEDs - SSL-ID: xy74h

Description This partial list contains information about the LEDs of the CPU.

Header



Content	Value	Description
SSL_ID	0074h	State of all LEDs without VIPA specific
	0174h	State of a particular LED, to specify via the INDEX
	0E74h	State of the VIPA specific LEDs
	0F74h	SSL partial list header information
INDEX		For SSL_ID 0074h: irrelevant For SSL_ID 0174h: INDEX specifies the LED for which the state is read out For SSL_ID 0E74h: INDEX = 0000h (mandatory)
LENTHDR	0004h	A record set is 2words long (4bytes).
N_DR	xxxxh	Number of record sets

Record set SSL-ID: xy74h

INDEX offset	Length	0074h	0174h	0E74h	Value	Description LED
0	1word	x	x	-	0001h	SF (Group error)
		x	x	-	0004h	RUN
		x	x	-	0005h	STOP
		x	x	-	0006h	FRCE (Force) ■ MICRO CPU: fix 0
		x	x	-	0008h	BATF (always "0") This INDEX only exists in CPUs configured as CPU 318-2AJ00. ■ SLIO CPU: fix 0 ■ MICRO CPU: fix 0
		x	x	-	000Bh	BF1: BUSF1 (Bus error interface 1) ■ 300S CPU DPM: fix 0 ■ 300S CPU PN/EC: PROFIBUS ERR LED ■ SLIO CPU PN/EC: PROFIBUS BF LED ■ MICRO CPU: -
		x	x	-	000Ch	BF2: BUSF2 (PROFINET Bus error interface 2) ■ 300S CPU DPM: PROFIBUS ERR LED ■ 300S CPU PN/EC: PROFIBUS BF LED ■ SLIO CPU PN/EC: CP BF1 LED ■ MICRO: -

INDEX offset	Length	0074h	0174h	0E74h	Value	Description LED
		-	x	x	0013h	BF3: BUSF3 (Bus error interface 3) <ul style="list-style-type: none"> ■ 300S CPU: - ■ SLIO CPU: PROFINET via Ethernet PG/OP channel: virtual BF LED ■ MICRO CPU: PROFINET via Ethernet PG/OP channel: virtual BF LED (VIPA specific)
		x	x	-	0015h	MT LED <ul style="list-style-type: none"> ■ SLIO CPU: CP: MT LED ■ MICRO CPU: -
		-	x	x	0025h	MT2 LED <ul style="list-style-type: none"> ■ 300S CPU: - ■ SLIO CPU: PROFINET via Ethernet PG/OP channel: virtual MT LED ■ MICRO CPU: PROFINET via Ethernet PG/OP channel: virtual MT LED (VIPA specific)
		-	x	x	0100h	BS1 (Bus state 1) <ul style="list-style-type: none"> ■ 300S CPU: EC LED ■ SLIO CPU PN/EC: BS1 LED ■ MICRO CPU: - (VIPA specific)
		-	x	x	0101h	BS2 (Bus state Ethernet PG/OP channel) <ul style="list-style-type: none"> ■ 300S CPU: - ■ SLIO CPU: PROFINET via Ethernet PG/OP channel: virtual BS LED ■ MICRO CPU: PROFINET via Ethernet PG/OP channel: virtual BS LED (VIPA specific)
		-	x	x	1000h	Access to memory card LED <ul style="list-style-type: none"> ■ 300S CPU: MMC LED ■ SLIO CPU: SD LED ■ MICRO CPU: virtual SD LED: blinking with 10Hz (VIPA specific)
		-	x	x	1001h	PROFIBUS Data Exchange slave LED <ul style="list-style-type: none"> ■ 300S Slave CPU: fix 0 ■ all other 300S CPUs: - ■ SLIO CPU: - ■ MICRO CPU: - (VIPA specific)
		-	x	x	1002h	MICRO: Status bar ( left green) (VIPA specific)

Status of the LEDs - SSL-ID: xy74h

INDEX offset	Length	0074h	0174h	0E74h	Value	Description LED
		-	x	x	1003h	MICRO: Status bar ( right green) (VIPA specific)
		-	x	x	1004h	MICRO: Status bar ( left red) (VIPA specific)
		-	x	x	1005h	MICRO: Status bar ( right yellow) (VIPA specific)
		-	x	x	2000h	<ul style="list-style-type: none"> ■ 300S CPU: DPM: RUN LED ■ SLIO CPU: 0 (fix) ■ MICRO CPU: - (VIPA specific)
		-	x	x	2001h	<ul style="list-style-type: none"> ■ 300S CPU: PROFIBUS: ERR LED ■ SLIO CPU: PROFIBUS: BF LED ■ MICRO CPU: - (VIPA specific)
		-	x	x	2002h	<ul style="list-style-type: none"> ■ 300S CPU: PROFIBUS: DE LED ■ SLIO CPU: PROFIBUS: DE LED ■ MICRO CPU: - (VIPA specific)
		-	x	x	2003h	<ul style="list-style-type: none"> ■ 300S CPU: DPM: IF LED ■ SLIO CPU: 0 (fix) ■ MICRO CPU: - (VIPA specific)
		-	x	x	6501h*	SF (Group error) from CP on 1. SPEED-Bus slot (User slot = 101)
		-	x	x	6504h*	RUN from CP on 1. SPEED-Bus slot (User slot = 101)
		-	x	x	6505h*	STOP from CP on 1. SPEED-Bus slot (User slot = 101)
		-	x	x	6601h*	SF (Group error) from CP on 2. SPEED-Bus slot (User slot = 102)
		-	x	x	6604h*	RUN from CP on 2. SPEED-Bus slot (User slot = 102)
		-	x	x	6605h*	STOP from CP on 2. SPEED-Bus slot (User slot = 102)
		-	x	x	6701h*	SF (Group error) from CP on 3. SPEED-Bus slot (User slot = 103)
		-	x	x	6704h*	RUN from CP on 3. SPEED-Bus slot (User slot = 103)

INDEX offset	Length	0074h	0174h	0E74h	Value	Description LED
		-	x	x	6705h*	STOP from CP on 3. SPEED-Bus slot (User slot = 103)
		-	x	x	6801h*	SF (Group error) from CP on 4. SPEED-Bus slot (User slot = 104)
		-	x	x	6804h*	RUN vom CP from CP on 4. SPEED-Bus slot (User slot = 104)
		-	x	x	6805h*	STOP from CP on 4. SPEED-Bus slot (User slot = 104)
		-	x	x	6901h*	SF (Group error) from CP on 5. SPEED-Bus slot (User slot = 105)
		-	x	x	6904h*	RUN from CP on 5. SPEED-Bus slot (User slot = 105)
		-	x	x	6905h*	STOP from CP on 5. SPEED-Bus slot (User slot = 105)
		-	x	x	6A01h*	SF (Group error) from CP on 6. SPEED-Bus slot (User slot = 106)
		-	x	x	6A04h*	RUN from CP on 6. SPEED-Bus slot (User slot = 106)
		-	x	x	6A05h*	STOP from CP on 6. SPEED-Bus slot (User slot = 106)
		-	x	x	6B01h*	SF (Group error) from CP on 7. SPEED-Bus slot (User slot = 107)
		-	x	x	6B04h*	RUN from CP on 7. SPEED-Bus slot (User slot = 107)
		-	x	x	6B05h*	STOP from CP on 7. SPEED-Bus slot (User slot = 107)
		-	x	x	6C01h*	SF (Group error) from CP on 8. SPEED-Bus slot (User slot = 108)
		-	x	x	6C04h*	RUN from CP on 8. SPEED-Bus slot (User slot = 108)
		-	x	x	6C05h*	STOP from CP on 8. SPEED-Bus slot (User slot = 108)
		-	x	x	6D01h*	SF (Group error) from CP on 9. SPEED-Bus slot (User slot = 109)
		-	x	x	6D04h*	RUN from CP on 9. SPEED-Bus slot (User slot = 109)

Status of the LEDs - SSL-ID: xy74h

INDEX offset	Length	0074h	0174h	0E74h	Value	Description LED
		-	x	x	6D05h*	STOP from CP on 9. SPEED-Bus slot (User slot = 109)
		-	x	x	6E01h*	SF (Group error) from CP on 10. SPEED-Bus slot (User slot = 110)
		-	x	x	6E04h*	RUN from CP on 10. SPEED-Bus slot (User slot = 110)
		-	x	x	6E05h*	STOP from CP on 10. SPEED-Bus slot (User slot = 110)
		-	x	x	CE01h*	SF (Group error) from CP to CPU (User slot = 206)
		-	x	x	CE04h*	RUN from CP to CPU (User slot = 206)
		-	x	x	CE05h*	STOP from CP to CPU (User slot = 206)
2	1byte	1byte	1byte	1byte		Status of one LED: <ul style="list-style-type: none"> ■ 0: off ■ 1: on
3	1byte	1byte	1byte	1byte		Flashing status of the LED: (decimal) <ul style="list-style-type: none"> ■ 0: off ■ 1: flashing normally (2Hz) ■ 2: flashing slowly (0.5Hz) ■ Note: EtherCat systemic flashing frequency 1Hz ■ 3: flashing with 1Hz (VIPA specific) ■ 4: flashing with 4Hz (VIPA specific) ■ 5: flashing with 2.5Hz (VIPA specific) ■ 6: flashing with 10Hz (VIPA specific) ■ 7: cyclically: short (200 ms) flashes once then off for 1000ms. (VIPA specific) ■ 8: cyclical: flashes twice briefly (200ms) then off for 1000ms. (VIPA specific) ■ 9: cyclically: three short flashes (200ms) then off for 1000ms. (VIPA specific) ■ 10: cyclical: remains 4 seconds, then 2 seconds off. (VIPA specific) ■ 11: flashes with 1.5Hz. (VIPA specific) ■ 12: flashes alternately with 1Hz with a second LED. (VIPA specific) ■ 13: flashes with 10Hz for 500ms, then off for 500ms. (VIPA specific)

*) This INDEX only exists in the CPUs 300S+ (up on V3.7)

17.16 Status information CPU - SSL-ID: xy91h

Description

If you read the partial list, you obtain the status information of modules assigned to the CPU. In this manual are only the available partial lists for the EtherCAT-CPU's described.

Not described are SSL partial list: 0191h, 0291h, 0391h, 0591h, 0991h.

Header

Content	Value	Description
SSL_ID	0091h	Module status information of all plugged and projected modules / submodules from the CPU
	0A91h	Module status information of a module in the central structure or at an integrated bus system (PROFIBUS, PROFINET or EtherCAT) via the logical base address.
	0C91h	Module status information of a module an external bus interface (PROFIBUS, PROFINET or EtherCAT) via the logical base address.
	4C91h	Module status information of all modules of the rack or the station (central, decentral PROFIBUS DP, PROFINET-IO or EtherCAT).
	0D91h	Module status information of all configured modules (central, decentral PROFIBUS DP, PROFINET-IO or EtherCAT)
	0E91h	Module status information of all assigned modules.
	0F91h	Only SSL parts list header information
INDEX	xxxxh	SSL_ID 0091h, 0A91h, 0E91h: INDEX irrelevant
		SSL_ID 0C91h and 4C91h: <ul style="list-style-type: none"> ■ Bits 0 ... 14: any logical address of the module ■ Bit 15: <ul style="list-style-type: none"> – 0 = Input – 1 = Output
		SSL_ID 0D91: <ul style="list-style-type: none"> ■ xx00h: Modules or submodules from the rack or station number. <ul style="list-style-type: none"> – With xx you have to specify the number of the rack. ■ xxyy: all modules of a DP station or a PROFINET-IO station or an EtherCAT station <ul style="list-style-type: none"> – PROFIBUS DP: <ul style="list-style-type: none"> xx: Contains the DP master system ID yy: Station number – PROFINET-IO: <ul style="list-style-type: none"> Bit 0 ... 10: Device number Bit 11 ... 14: the last two digits of the PN IO Subsystem ID Bit 15: 1 – EtherCAT: <ul style="list-style-type: none"> Bit 0 ... 10: Slave number Bit 11 ... 14: the last two digits of the EtherCAT Subsystem ID Bit 15: 1
LENTHDR	0010h	A record set is 8words long (16bytes).
N_DR	xxxxh	Number of record sets; product-specific, the number of transmitted record set can be less

Status information CPU - SSL-ID: xy91h

Additional Record sets

In the case of *SSL_ID* 0091h and 0F91h two additional record sets are supplied per rack:

- A record for the power supply if it exists
- A record set for the rack

The sequence of the records in case of a centralized structure is:

Power supply, slots 1 ... n, rack



The record set starts always from the first assigned logical I/O address (basic address).

Record set *SSL_ID*: xy91h:

INDEX offset	Name	Length	Description				
0	adr1	1word	↳ 'adr1' page 979				
2	adr2	1word	↳ 'adr2' page 980				
4	logadr	1word	First assigned logical I/O address (basic address).				
6	solltyp	1word	Target type: only at PROFINET or EtherCAT (otherwise reserved)				
8	isttyp	1word	Actual type: only at PROFINET or EtherCAT (otherwise reserved)				
10	reserved	1word	<ul style="list-style-type: none"> ■ At PROFINET-IO or EtherCAT (otherwise reserved): <ul style="list-style-type: none"> – <i>SSL-ID</i> = 0C91h: Number of really existing submodules (without submodule 0) – <i>SSL-ID</i> = 0D91h: Number of submodules (without submodule 0) – <i>SSL-ID</i> = 4C91h: Number of really existing submodules (without submodule 0) – <i>SSL-ID</i> = 4D91h: Number of really existing submodules (without submodule 0) 				
12	eastat	1word	<ul style="list-style-type: none"> ■ I/O status: <ul style="list-style-type: none"> – Bit 0: 1: Module error (detected by diagnostic interrupt) – Bit 1: 1: Module exists – Bit 2: 1: Module does not exist – Bit 3: 1: Module disabled – Bit 4: 1: Station error – Bit 5: 1: A CiR event at this module /station is busy or not yet completed. – Bit 6: 1: reserved – Bit 7: 1: Module in local bus segment – Bit 8 ... 15: Data ID for logical address (Input: B4h, Output: B5h, DP interface: FFh) 				
14	ber_bgr	1word	<ul style="list-style-type: none"> ■ Area ID/module width <ul style="list-style-type: none"> – Bit 0 ... 2: Module width – Bit 3: reserved – Bit 4 ... 6: Area ID <table border="1" style="width: 100%; margin-top: 5px;"> <tr> <td>0:</td> <td>Siemens S7-400</td> </tr> <tr> <td>1:</td> <td>Siemens S7-300</td> </tr> </table>	0:	Siemens S7-400	1:	Siemens S7-300
0:	Siemens S7-400						
1:	Siemens S7-300						

INDEX offset	Name	Length	Description
			2: ET area (PROFIBUS / PROFINET / EtherCAT-decentralized)
			3: P area
			4: Q area
			5: IM3 area
			6: IM4 area
			7: Consistent area (PROFIBUS slave)
			Bit 7 ... 15: reserved

- adr1**
- *At a centralized configuration*
 - Rack number

adr1																
High byte								Low byte								
Bit number	15	14	13	12	11	10	9	8	7	6	5	4	3	2	1	0
	0							Rack number (0 ... 31)								

- *At a decentralized configuration with PROFIBUS DP*
 - DP master system ID
 - Station number
 - Bit 15: "0" ID for PROFIBUS

adr1																	
High byte								Low byte									
Bit number	15	14	13	12	11	10	9	8	7	6	5	4	3	2	1	0	
	0	DP master system ID (1 ... 32)							Station number (0 ... 127)								

- *At a decentralized configuration with PROFINET IO or EtherCAT*
 - Station number
 - To obtain the full PROFINET IO system ID, you have to add 100 (decimal) to bit 12 ... 14.
 - Bit 15: "1" ID for PROFINET or EtherCAT

adr1																
High byte								Low byte								
Bit number	15	14	13	12	11	10	9	8	7	6	5	4	3	2	1	0
	1	PROFINET IO system ID (0...15)			Station number (0 ... 2047)											

Stations status information (DPM) - SSL-ID: xy92h

- adr2**
- At a centralized respectively decentralized structure with PROFIBUS DP
 - Slot number and submodule slot number
 - for a decentralized configuration with PROFINET-IO or EtherCAT
 - Slot number

adr2																
High byte								Low byte								
Bit number	15	14	13	12	11	10	9	8	7	6	5	4	3	2	1	0
Slot number								Submodule slot number								

17.17 Stations status information (DPM) - SSL-ID: xy92h

Description If you read this partial list, you obtain information about the expected and the current hardware configuration of centrally installed stations of a DP master system, connected via a DP interface.

Header

Content	Value	Description
SSL_ID	0092h	Expected status of the central stations of a DP master system.
	0292h	Actual status of the stations of a DP master system.
	0692h	Diagnostic status of the expansion racks in the central configuration of the stations of a DP master system.
	4092h	Expected status of a DP master system, which is connected via an external DP switch.
	4192h	Activation status of a DP master system, which is connected via an external DP switch.
	4292h	Actual status of a DP master system, which is connected via an external DP switch.
	4692h	Diagnostic status of the expansion racks of a DP master system, which is connected via an external DP switch.
	4F92	Only SSL parts list header information of part list 4x92h
INDEX	xxxxh	DP mastersystem ID
LENTHDR	0010h	One record set is 8words long (16bytes).
N_DR	xxxxh	Number of record sets

Record set SSL_ID: xy92h

INDEX Offset	Name	Length	Description	
0	status_0 ... status_15	16byte	Rack status / station status or backup status (the backup status is only relevant for DP modules).	
			0092h:	0: Rack/station not configured
				1: Rack/station configured
			4092h:	0: Station not configured
1: Station configured				

Stations status information (DPM) - SSL-ID: xy92h

INDEX Offset	Name	Length	Description	
			0292h:	0: Rack/station failure, deactivated or not configured
				1: Rack/station exists, is activated and has not failed
			0692h:	0: All modules of the expansion rack / of a station exist, are available with no problems and activated.
				1: At least 1 module of the expansion rack / of a station is not OK or the station is deactivated.
			4692h:	0: All modules of a station exist, are available with no problems, and activated.
				1: At least 1 module of a station is not OK or the station is deactivated.
0	status_0	1byte	Bit 0:	Central rack (INDEX = 0) or station 1 (INDEX > 0)
			Bit 1:	1. Expansion rack or station 2
		
			Bit 7:	7. Expansion rack or station 8
1	status_1	1byte	Bit 0:	8. Expansion rack or station 9
		
			Bit 7:	15. Expansion rack or station 16
2	status_2	1byte	Bit 0:	16. Expansion rack or station 17
		
			Bit 5:	21. Expansion rack or station 22
			Bit 6:	0 or station 23
			Bit 7:	0 or station 24
3	status_3	1byte	Bit 0:	0 or station 25
		
			Bit 5:	0 or station 30
			Bit 6:	Expansion rack in Siemens S5 area or station 31
			Bit 7:	0 or station 32
4	status_4	1byte	Bit 0:	0 or station 33
		
			Bit 7:	0 or station 40

15	status_15	1byte	Bit 0:	0 or station 121
		
			Bit 7:	0 or station 128

Stations status information (DPM, PROFINET-IO, EtherCAT) - SSL-ID: xy94h

17.18 Stations status information (DPM, PROFINET-IO, EtherCAT) - SSL-ID: xy94h

Description

If you read this partial list, you obtain information about the expected and the current hardware configuration of centrally installed stations of a DP master system / PROFINET IO controller system or EtherCAT master system.

Header

Content	Value	Description
SSL_ID	0094h	Expected status of the central stations of a PROFINET-IO control system / PN IO subsystem-ID With EtherCAT only the stations configured as <i>mandatory</i> are registered. ■ Status bit = 1: – Rack/station configure
	0194h	Activation status of a station of an IO controller system, which is configured and disabled. ■ Status bit = 1
	0294h	Actual state of the rack in the central configuration of the stations of an IO controller system ■ Status bit = 1: – Rack/station exists, activated and not failed
	0694h	Diagnostic status of the expansion racks in the central configuration of the stations of a PROFINET-IO control system / PN IO subsystem-ID ■ Status bit = 1: – at least one module of rack/station has malfunction or is de-activated: coming diagnostics interrupt, neighbourhood interrupt, remove/fit interrupt, failure mandatory station
	0794h	Diagnostic / Maintenance condition of the central stations of a PROFINET-IO control system / PN IO subsystem-ID ■ Status bit = 0: – no problem and no maintenance necessary ■ status bit = 1: – rack/station has a problem or maintenance requirement or maintenance request
	0994h	Set point - actual value difference ■ Status bit = 1: – Set point - actual value difference in station exists ModDiffBlock, EC state unequal master state
	0A94h	Set point state of the stations of an EtherCAT IO controller system. In this partial list besides the <i>mandatory</i> stations additionally the <i>optional</i> configured stations are registered. ■ Status bit = 1: – Rack/station configured
	0F94h	SSL partial list header information
	INDEX	xxxxh

Stations status information (DPM, PROFINET-IO, EtherCAT) - SSL-ID: xy94h

Content	Value	Description
LENTHDR	0102h	One record set is 129words long (258bytes).
N_DR	xxxxh	Number of record sets

Record set **SSL_ID: xy94h**

INDEX offset	Content	Length	Description
0	INDEX	1word	<ul style="list-style-type: none"> ■ 0: Central module ■ 1 ... 31: Distributed module at PROFIBUS DP ■ 100 ... 115: Distributed module at PROFINET-IO / EtherCAT-IO
2	status_0	BOOL	<ul style="list-style-type: none"> ■ Group information: <ul style="list-style-type: none"> – 1: one of the following status bits has the value 1 – 0: all subsequent status bits have the value 0
...	status_1	BOOL	Status station 1
	status_2	BOOL	Status station 2

	status_2047	BOOL	Status station 2047

A status bit of non-configured racks/stations/devices has the value 0.

**Important difference to
SSL_ID xy92h**

Compared to SSL_ID xy92h, the data have been shifted by one bit since bit status_0 is used for group information.

Local SLIO bus

- A virtual PN device on the PROFINET network is configured for the SLIO CPU of a local SLIO bus. The corresponding SSL_ID xy94h is filled with this configured station number.
- If no virtual PN Device for the SLIO bus is configured, then natively for the station number 2047 is used.

EtherCAT bus

- A virtual PN device is configured on the PROFINET network for the EtherCAT network. The corresponding SSL xy94h is filled with this configured station number.
- The EtherCAT master (controller) has normally the station number 0. This can not be located in the SSL xy94h because the bit 0 is used as a group bit. Thus is set in Topology Mismatch in the SSL xy94h the bit for the station 512 (maximum station number for EtherCAT).

Status information PROFINET/EtherCAT/PB DP - SSL-ID: xy96h

Local SLIO bus with EtherCAT CPU



With an EtherCAT CPU, please note that addressing in the virtual PROFINET system requires no duplicate station addresses. Otherwise this results in a double assignment of the corresponding bit in the SSL_ID xy94h.

17.19 Status information PROFINET/EtherCAT/PB DP - SSL-ID: xy96h

Description

This partial list contains status information on all the modules assigned to the CPU. It provides information specific to PROFINET IO as well as information on PROFIBUS DP modules, EtherCAT modules and central modules. Complementing *SSL_ID* xy91 you get on the partial list with the *SSL_ID* xy96 additional state information of modules and sub-modules.

Header

Content	Value	Description
SSL_ID	0696h	Module status information of all submodules of a specified module (only with integrated interface with PROFINET IO) address with IO identifier.
	0C96h	Module status information of a module/submodule located centrally or on a PROFIBUS DP / PROFINET / EtherCAT interface module over the start address.
INDEX	xxxxh	<ul style="list-style-type: none"> ■ Bit 0 ... 14: Logical base address of the module ■ Bit 15: <ul style="list-style-type: none"> – 0: Input – 1: Output
LENTHDR	0030h	Length of the data record is 24words (48byte).
N_DR	xxxxh	Number of record sets

Record set *SSL_ID: xy96h*

INDEX offset	Length	Description
0	1word	<ul style="list-style-type: none"> ■ Bits 0 ... 14: Address of the module ■ Bit 15: <ul style="list-style-type: none"> – 0: Input – 1: Output
2	1word	ID for centralized module / DP master system ID / PROFINET IO system ID / EtherCAT system: <ul style="list-style-type: none"> ■ 0: Central Module ■ 1 ... 31: Decentralized module at PROFIBUS DP ■ 100 ... 115: Decentralized module at PROFINET-IO / EtherCAT-IO
4	2words	Not relevant
8	1word	Rack no./station number/device number
10	1word	Slot number
12	1word	Submodule slot number (Enter 0 if no submodule can be installed)

INDEX offset	Length	Description	
14	1word	Not relevant	
16	7words	Set point type: With PROFINET-IO the structure of the set point type is hierarchical	
		PROFINET-IO / EtherCAT-IO	PROFIBUS DP
	1. word:	Vendor number or profile ID	0000
	2. word:	Product code (High Word)	0000
	3. word:	Product code (Low Word)	0000
	4. word:	1. Word of the double word Module identification	Type ID
	5. word:	2. Word of the double word Module identification	0000
	6. word:	1. Word of the double word submodule identification with EtherCAT-IO: reserved	0000
7. word:	2. Word of the double word submodule identification with EtherCAT-IO: reserved	0000	
30	1word	ID set point/actual <ul style="list-style-type: none"> ■ Bit 0 = 0: Set point equal actual ■ Bit 0 = 1: Set point unequal actual ■ Bit 1 ... 15: reserved 	
32	1word	reserved	
34	1word	I/O status: <ul style="list-style-type: none"> ■ Bit 0: 1: Module has malfunction (detected by diagnostics) ■ Bit 1: 1: Module exists ■ Bit 2: 1: Module not available ■ Bit 3: 1: Module de-activated ■ Bit 4: 1: Station has malfunction ■ Bit 5, 6: reserved ■ Bit 7: 1: Module in local bus segment ■ Bit 8: 1: Module maintenance required ■ Bit 9: 1: Module maintenance request ■ Bit 10 ... 15: reserved 	

Diagnostic buffer of the CPU/CP - SSL-ID: xyA0h

INDEX offset	Length	Description
36	1word	Area ID/module width <ul style="list-style-type: none"> ■ Bit 0 ... 2: Module width ■ Bit 3: reserved ■ Bit 4 ... 6: Area ID <ul style="list-style-type: none"> – 0: Siemens S7-400 – 1: Siemens S7-300 – 2: PROFINET IO (decentralized) – 3: P area – 4: Q area – 5: IM3 area – 6: IM4 area – 7: EtherCAT (decentralized) ■ Bit 7 ... 15: reserved
38	5words	reserved



Note!

*Partial List with SSL-ID 0696h for modules with PROFIBUS DP:
This results in the error message "submodule level not present".*

17.20 Diagnostic buffer of the CPU/CP - SSL-ID: xyA0h

Description

If you read the partial list, you obtain the entries of the diagnostic buffer of your CPU or your CP.

Header

Content	Value	Description
SSL_ID	00A0h	Shows all entries of the diagnostics buffer, which are possible in the current mode.
	01A0h	Shows the most recent entries of the diagnostics buffer.
	0FA0h	<ul style="list-style-type: none"> ■ SSL partial list header information <ul style="list-style-type: none"> – Length of an entry and how many entries there can be.
INDEX	xxxxh	SsL_ID: 01A0h: Number of the most recent entries to be delivered.
LENTHDR	0014h	A record set is 10words long (20bytes).
N_DR	xxxxh	Number of record sets

Record set SSL_ID: 00A0h and 01A0h

INDEX offset	Length	Description
0	1word	Event ID
2	1byte	Depending on the diagnostic buffer entry
3	1byte	Depending on the diagnostic buffer entry
4	1word	Depending on the diagnostic buffer entry
6	1word	Information about the event
8	1word	Information about the event
10	1word	Information about the event
12	4words	Time stamp of the event (DATE_AND_TIME)

DATE_AND_TIME

DATE_AND_TIME: BCD format

INDEX offset	Description	Area
0	year	1990 ... 2089
1	month	01 ... 12
2	day	1 ... 31
3	hour	0 ... 23
4	minute	0 ... 59
5	second	0 ... 59
6	<ul style="list-style-type: none"> ■ 2 MSD from ms – MSD: Most Significant Decade 	00 ... 99
7 (4 MSB)	<ul style="list-style-type: none"> ■ LSD from ms – LSD: Least Significant Decade 	0 ... 9
7 (4 LSB)	weekday	1 ... 7 (1 = Sunday)

Diagnostic buffer

More information about the events in the diagnostics buffer of your CPU may be found in the manual of your CPU or in the manual of you programming software.

Module diagnostic information - SSL-ID: 00B1h

17.21 Module diagnostic information - SSL-ID: 00B1h

Description If you read this partial list, you obtain the first 4 diagnostic bytes of a module with diagnostic capability.

Header

Content	Value	Description
SSL_ID	00B1h	Shows the first 4 diagnostic bytes of a module.
INDEX	xxxxh	Here the following is to be specified via INDEX: <ul style="list-style-type: none"> ■ Bit 0 ... 14: Logical base address of the module ■ Bit 15: <ul style="list-style-type: none"> – 0: Input – 1: Output
LENTHDR	0004h	A record set is 2words long (4bytes).
N_DR	0001h	Number of record set (1)

Record set *SSL_ID: 00B1h*

INDEX offset	Length	Description
0	1byte	<ul style="list-style-type: none"> ■ Bit 0: Module fault (group fault ID) ■ Bit 1: Internal fault ■ Bit 2: External fault ■ Bit 3: Channel error exists ■ Bit 4: No external auxiliary voltage ■ Bit 5: No front connector ■ Bit 6: Module not assigned parameters ■ Bit 7: Wrong parameters on module
1	1byte	<ul style="list-style-type: none"> ■ Bit 0 ... 3: Module class <ul style="list-style-type: none"> – 0000: CPU – 0101: Analog modules – 1000: FM – 1100: CP – 1111: Digital modules – 0011: DP Norm slave – 0100: IM ■ Bit 4: Channel information exists ■ Bit 5: User information exists ■ Bit 6: Diagnostic interrupt from substitute ■ Bit 7: Maintenance requirement (PROFINET IO only)

INDEX offset	Length	Description
2	1byte	<ul style="list-style-type: none">■ Bit 0: User module incorrect / does not exist■ Bit 1: Communication fault■ Bit 2: Mode<ul style="list-style-type: none">– 0: RUN– 1: STOP■ Bit 3: Watchdog responded■ Bit 4: Internal module power supply failed■ Bit 5: Battery exhausted■ Bit 6: Entire buffer failed■ Bit 7: Maintenance requirement (PROFINET IO only)
3	1byte	<ul style="list-style-type: none">■ Bit 0: Expansion rack failure (detected by IM)■ Bit 1: Processor failure■ Bit 2: EPROM error■ Bit 3: RAM error■ Bit 4: ADC/DAC error■ Bit 5: Fuse blown■ Bit 6: Hardware error lost■ Bit 7: reserved (fix 0)

Module diagnostic information via physical address - SSL-ID: 00B2h

17.22 Module diagnostic information via physical address - SSL-ID: 00B2h

Description

If you read this partial list, you obtain the diagnostic record set 1 of a module in a central rack (not for PROFIBUS DP or submodules). The diagnostic record 1 contains the 4 bytes of diagnostic data that are also in data record 0, plus module-specific diagnostics data that describe the state of a channel or a channel group. The module is to be specified via rack and slot number.

Header

Content	Value	Description
SSL_ID	00B2h	Shows diagnostic record set 1 of a module.
INDEX	xxyyh	Here the following is to be specified via INDEX: <ul style="list-style-type: none"> ■ xx: Number of the rack ■ yy: Slot number of the module
LENTHDR	xxxxh	The length of the record set depends on the module.
N_DR	0001h	Number of record set (1)

Record set



Information to length and structure of the diagnostic record set may be found in the corresponding manual of your diagnosable module. The first 4 bytes correspond to the data record 0 of the module. ↗ Chap. 17.21 'Module diagnostic information - SSL-ID: 00B1h' page 988

17.23 Module diagnostic information via logical address - SSL-ID: 00B3h

Description

If you read this partial list, you obtain all the diagnostic data of a module. You can also obtain this information for PROFIBUS DP and submodules. The diagnostic record 1 contains the 4 bytes of diagnostic data that are also in data record 0, plus module-specific diagnostics data that describe the state of a channel or a channel group. The module is to be specified via the logical base address.

Header

Content	Value	Description
SSL_ID	00B3h	Shows all the diagnostic data of a module.
INDEX	xxxxh	Here the following is to be specified via INDEX: <ul style="list-style-type: none"> ■ Bit 0 ... 14: Logical base address of the module ■ Bit 15: <ul style="list-style-type: none"> – 0: Input – 1: Output
LENTHDR	xxxxh	The length of the record set depends on the module.
N_DR	0001h	Number of record set (1)

Record set



Information to length and structure of the diagnostic data may be found in the corresponding manual of your diagnosable module.

Diagnostic data of a DP slave - SSL-ID: 00B4h

17.24 Diagnostic data of a DP slave - SSL-ID: 00B4h

Description

If you read this partial list, you obtain the diagnostic data of a PROFIBUS DP slave. This diagnostic data is structured in compliance with EN 50 170 Volume 2, PROFIBUS. The module is to be specified via the configured diagnostic address.

Header

Content	Value	Description
SSL_ID	00B4h	Shows all the diagnostic data of a PROFIBUS DP slave.
INDEX	xxxxh	Here the configured diagnostic address of the DP slave is to be specified with INDEX.
LENTHDR	xxxxh	Length of a record set The maximum length is 240bytes. For standard slaves, which have a diagnostic data length of more than 240bytes up to a maximum of 244bytes, the first 240bytes are read and the overflow bit is set in the data.
N_DR	0001h	Number of record set (1)

Record set *SSL_ID: 00B4h*

INDEX offset	Length	Description
0	1byte	Station status 1
1	1byte	Station status 2
2	1byte	Station status 3
3	1byte	Number of master station
4	1byte	Vendor ID (high byte)
5	1byte	Vendor ID (low byte)
...	...	Further diagnostic data specific to the particular slave

17.25 Information EtherCAT master/slave - SSL-ID: xyE0h

Description This SSL partial list is a VIPA specific SSL to request EtherCAT states of master/slave via logical and geographical addresses.

Header

Content	Value	Description
SSL_ID	x0E0h	State info of a master + all the configured slaves via the ID of the EtherCAT network <ul style="list-style-type: none"> ■ Bit 0 ... 10: <ul style="list-style-type: none"> – not relevant (all devices, max. 512+1) ■ Bit 11 ... 14: <ul style="list-style-type: none"> – System-ID¹ of the EtherCAT network - 100 ■ Bit 15: <ul style="list-style-type: none"> – 1: ID bit for EtherCAT (PROFINET "look and feel")
	xCE0h	State info of the EtherCAT master/slave via logical base address <ul style="list-style-type: none"> ■ Bits 0 ... 14: <ul style="list-style-type: none"> – logical base address of the EtherCAT device ■ Bit 15: <ul style="list-style-type: none"> – 0 = Input – 1 = Output
	xDE0h	State info of a EtherCAT master/slave via the geographical address <ul style="list-style-type: none"> ■ Bit 0 ... 10: <ul style="list-style-type: none"> – Master/slave ID ■ Bit 11 ... 14: <ul style="list-style-type: none"> – System-ID¹ of the EtherCAT network-100 ■ Bit 15: <ul style="list-style-type: none"> – 1: ID bit for EtherCAT (PROFINET "look and feel")
	xFE0h	SSL partial list header information
INDEX	xxxxh	not relevant
LENTHDR	0001h	A record set is 1byte long
N_DR		<ul style="list-style-type: none"> ■ x0E0h: Number of record sets <ul style="list-style-type: none"> – (512 slaves + 1 master) ■ xCE0h, xDE0h: Number of record sets

1) Refer PROFINET IO system ID, because EtherCAT is configured as PROFINET in the Siemens SIMATIC Manager.

Record set *SSL_ID: xyE0h*

INDEX offset	Länge	Value	Description
0	1 Byte	00h	Undefined/Unknown
		01h	Init
		02h	PreOp
		03h	BootStrap
		04h	SafeOp

Information EtherCAT master/slave - SSL-ID: xyE0h

INDEX offset	Länge	Value	Description
		08h	Op
		FFh	NotProjected (für nicht projektierte EtherCAT Peripherie)

17.26 EtherCAT bus system - SSL-ID: xyE1h

Description This SSL partial list is a VIPA specific SSL to request information from the EtherCAT bus system.

Header

Content	Value	Description
SSL_ID	0CE1h	State info of the EtherCAT master via logical base address <ul style="list-style-type: none"> ■ Bits 0 ... 14: <ul style="list-style-type: none"> – logical base address of the EtherCAT master (diagnostics address of the interface) ■ Bit 15: <ul style="list-style-type: none"> – 0 = Input – 1 = Output
	0DE1h	State info of a EtherCAT master via the geographical address <ul style="list-style-type: none"> ■ Bit 0 ... 10: <ul style="list-style-type: none"> – not relevant ■ Bit 11 ... 14: <ul style="list-style-type: none"> – System-ID ¹ of the EtherCAT network - 100 ■ Bit 15: <ul style="list-style-type: none"> – 1: ID bit for EtherCAT (PROFINET "look and feel")
	0FE1h	SSL partial list header information
INDEX	xxxxh	not relevant
LENTHDR	0004h	A record set is 2words long (4bytes).
N_DR	0001h	Number of record sets (1)

1) Refer PROFINET IO system ID, because EtherCAT is configured as PROFINET in the Siemens SIMATIC Manager.

Record set *SSL_ID: xyE1h*

INDEX offset	Length	Description
0	2words	Information via the EtherCAT bus system <ul style="list-style-type: none"> ■ Bit 0: <ul style="list-style-type: none"> – 0: Topology OK – 1: Topology Mismatch ■ Bit 1: <ul style="list-style-type: none"> – 0: DC master out of "sync" – 1: DC master in "sync" ■ Bit 2: <ul style="list-style-type: none"> – 0 = DC slaves out of "sync" – 1 = DC slaves in "sync" ■ Bit 3 ... 31: reserved

Statistics information to OBs - SSL-ID: xyFAh

17.27 Statistics information to OBs - SSL-ID: xyFAh

Description This partial list contains statistical information about the OBs (additionally OB 60 and OB 61).

Header

Content	Value	Description
SSL_ID	00FAh	All statistical information for OB xx (5 record sets with 24bytes)
	01FAh	Response time: time between the request and the start of execution
	02FAh	Process image of the inputs (only relevant for OBs are assigned a process image)
	03FAh	OB execution time: included alarm interrupts
	04FAh	Process image of the outputs (only relevant for OBs are assigned a process image)
	05FAh	Processing time: Time for an execution cycle of request until the completion of processing follow up
	0FFAh	SSL partial list header information
INDEX	xx00h	Statistical information for all used OBs (additionally OB 60 and OB 61)
	xx3Ch	Statistical information for OB 60
	xx3Dh	Statistical information for OB 61
LENTHDR	0018h	One record set is 12words long (24byte)
N_DR	xxxxh	Number of record sets



- The times must be specified in μ s
- During startup, the times are reset to zero - without minimum times.
- The minimum times are assigned with the value FFFFh.

Record set

SSL-ID: 01FAh

The data set includes the response time. This is the time between the request and the start of execution. This time also includes a process input image.

INDEX offset	Length	Value	Description
0	1byte	01h	Number of partial list: <i>SSL Sub ID</i>
1	1byte	xxh	OB Number: statistical information for OB xx (INDEX see above)
2	1word	xxxxh	reserved
4	2words	xxxxxxxxh	Minimum execution time: The smallest measured time
8	2words	xxxxxxxxh	Maximum execution time: Maximum measured time
12	2words	xxxxxxxxh	Last run time: Last measured time
16	2words	xxxxxxxxh	Average execution time: The time is determined by the last 1000 recorded times.
20	2words	xxxxxxxxh	reserved



- *The times must be specified in μ s*
- *The measurement of time starts with the first transition from Startup to RUN.*

Record set

SSL-ID: 02FAh

The data set includes the time taken to create the process image of inputs. Only relevant for OBs which a process image is assigned.

INDEX offset	Length	Value	Description
0	1byte	02h	Number of partial list: <i>SSL Sub ID</i>
1	1byte	xxh	OB Number: statistical information for OB xx (INDEX see above)
2	1word	xxxxh	reserved
4	2words	xxxxxxxxh	Minimum execution time: The smallest measured time
8	2words	xxxxxxxxh	Maximum execution time: Maximum measured time
12	2words	xxxxxxxxh	Last run time: Last measured time
16	2words	xxxxxxxxh	Average execution time: The time is determined by the last 1000 recorded times.
20	2words	xxxxxxxxh	reserved



- *The times must be specified in μ s*
- *The measurement of time starts with the first transition from Startup to RUN.*

Statistics information to OBs - SSL-ID: xyFAh

Record set

SSL-ID: 03FAh

The data set contains the execution time of the OBs. This is the time between the start of the OBs until leaving the OB including all alarm interrupts and SFC operations. The time from a higher priority OB is executed by a synchronous or asynchronous error is counted with.

INDEX offset	Length	Value	Description
0	1byte	03h	Number of partial list: <i>SSL Sub ID</i>
1	1byte	xxh	OB Number: statistical information for OB xx (INDEX see above)
2	1word	xxxxh	reserved
4	2words	xxxxxxxxh	Minimum execution time: The smallest measured time
8	2words	xxxxxxxxh	Maximum execution time: Maximum measured time
12	2words	xxxxxxxxh	Last run time: Last measured time
16	2words	xxxxxxxxh	Average execution time: The time is determined by the last 1000 recorded times.
20	2words	xxxxxxxxh	reserved



- *The times must be specified in μ s*
- *The measurement of time starts with the first transition from Startup to RUN.*

Record set

SSL-ID: 04FAh

The data set includes the time for creating the process image of outputs. Only relevant for OBs which a process image is assigned.

INDEX offset	Length	Value	Description
0	1byte	04h	Number of partial list: <i>SSL Sub ID</i>
1	1byte	xxh	OB Number: statistical information for OB xx (INDEX see above)
2	1word	xxxxh	reserved
4	2words	xxxxxxxxh	Minimum execution time: The smallest measured time
8	2words	xxxxxxxxh	Maximum execution time: Maximum measured time
12	2words	xxxxxxxxh	Last run time: Last measured time
16	2words	xxxxxxxxh	Average execution time: The time is determined by the last 1000 recorded times.
20	2words	xxxxxxxxh	reserved



- The times must be specified in μ s
- The measurement of time starts with the first transition from Startup to RUN.

Record set**SSL-ID: 05FAh**

The data set contains the determined times for one execution cycle. This is the time between the request and the full completion of the processing.

INDEX offset	Length	Value	Description
0	1byte	05h	Number of partial list: <i>SSL Sub ID</i>
1	1byte	xxh	OB Number: statistical information for OB xx (INDEX see above)
2	1word	xxxxh	reserved
4	2words	xxxxxxxxh	Minimum execution time: The smallest measured time
8	2words	xxxxxxxxh	Maximum execution time: Maximum measured time
12	2words	xxxxxxxxh	Last run time: Last measured time
16	2words	xxxxxxxxh	Average execution time: The time is determined by the last 1000 recorded times.
20	2words	xxxxxxxxh	Error counter: This counter is increased at the time, when the execution cycle is longer than 60% of the projected Sync clock.



- The times must be specified in μ s
- The measurement of time starts with the first transition from Startup to RUN.
- The cycle time of the Sync signal is set (HW configuration) via the CPU properties.

VSC features - SSL-ID: xyFCh

17.28 VSC features - SSL-ID: xyFCh

Description

Via this partial list you get the current status of the VSC features of the System SLIO CPU. There are features at the VIPA memory card to unlock e.g. additional memory or PROFIBUS functionality.

Header

Content	Value	Description
SSL_ID	00FCh	Status of all the VSC features (INDEX irrelevant)
	01FCh	Status of one VSC features
INDEX		Specifies the VSC feature, whose state is requested
	0001h	VSC feature PROFIBUS
	0002h	VSC feature memory extension
	0003h	VSC feature Timeout
	0004h	VSC feature CP fieldbus
	0005h	VSC feature motion
LENTHDR	xxx4h	Length of the following record set in byte
N_DR	xxxxh	Number of record sets

Record set *SSL_ID*: 00FCh

INDEX Offset	Length	Description
0	2words	VSC_Feature PROFIBUS-DP <ul style="list-style-type: none"> ■ 0 = PROFIBUS_NO ■ 1 = PROFIBUS_MASTER ■ 2 = PROFIBUS_SLAVE
4	2words	VSC_Feature MemKeySize <ul style="list-style-type: none"> ■ Size of the memory extension via VSC card in byte
8	2words	VSC TimeOut <ul style="list-style-type: none"> ■ Remaining time of the CPU with removed VSC card in ms (for S7 data type Time)
12	2words	VSC_Feature CpFieldbus <ul style="list-style-type: none"> ■ 0 = FEATURE_SET_CP_FIELDBUS_NO ■ 1 = FEATURE_SET_CP_FIELDBUS_ETHERCAT
16	2words	VSC_Feature Motion <ul style="list-style-type: none"> ■ 0 = FEATURE_SET_MOTION_NO ■ 1 = FEATURE_SET_MOTION_8AXIS ■ 2 = FEATURE_SET_MOTION_20AXIS
20	2words	FSC_Feature HMI <ul style="list-style-type: none"> ■ 0 = FEATURE_SET_HMI_NO ■ 1 = FEATURE_SET_HMI_ACTIVATED

Record set **SSL_ID: 01FCh INDEX: 0001h**

INDEX Offset	Length	Description
0	2words	VSC_Feature PROFIBUS <ul style="list-style-type: none"> ■ 0 = PROFIBUS_NO ■ 1 = PROFIBUS_MASTER ■ 2 = PROFIBUS_SLAVE

Record set **SSL_ID: 01FCh INDEX: 0002h**

INDEX Offset	Length	Description
0	2words	VSC_Feature MemKeySize <ul style="list-style-type: none"> ■ Größe der Speichererweiterung durch VSC-Karte in Byte

Record set **SSL_ID: 01FCh INDEX: 0003h**

INDEX Offset	Length	Description
0	2words	FSC TimeOut <ul style="list-style-type: none"> ■ Restlaufzeit der CPU bei gezogener VSC-Karte in ms (für S7-Datentyp Time)

Record set **SSL_ID: 01FCh INDEX: 0004h**

INDEX Offset	Length	Description
0	2words	VSC_Feature CpFieldbus <ul style="list-style-type: none"> ■ 0 = FEATURE_SET_CP_FIELDBUS_NO ■ 1 = FEATURE_SET_CP_FIELDBUS_ETHERCAT

Record set **SSL_ID: 01FCh INDEX: 0005h**

INDEX Offset	Length	Description
0	2words	VSC_Feature Motion <ul style="list-style-type: none"> ■ 0 = FEATURE_SET_MOTION_NO ■ 1 = FEATURE_SET_MOTION_8AXIS ■ 2 = FEATURE_SET_MOTION_20AXIS

Record set **SSL_ID: 01FCh INDEX: 0006h**

INDEX Offset	Length	Description
0	2words	FSC_Feature HMI <ul style="list-style-type: none"> ■ 0 = FEATURE_SET_HMI_NO ■ 1 = FEATURE_SET_HMI_ACTIVATED

18 Index

A

Abbreviations	21
Access Control	107
Addressing examples	28
Asynchronous error Interrupts	84
Axis control	542
ErrorID	637
HMI	613
States	633

B

Block instructions	35
Block parameters	66
Building Control	102

C

Combination instructions	
Bit	55
Word	63
Communication Interrupts	74
Comparison instructions	53
Comparison of syntax languages	24
Converting	795
Counter instructions	65
CP040	219
CP240	230
Cyclic Interrupts	80

D

Data type	265
DATE_AND_TIME	805
Data type conversion instructions	51
Device Specific	246
DS-ID	265

E

Edge-triggered instructions	37
Energy Measurement	264
ErrorID	637
EtherCAT Communication	238
Ethernet Communication	137

F

FB 1	215
------------	-----

FB 7	216
FB 8	154, 217
FB 9	155
FB 12	158, 737
FB 13	161, 740
FB 14	163, 742
FB 15	165, 744
FB 20	821
FB 21	822
FB 22	822
FB 23	824
FB 41	835
FB 42	841
FB 43	846
FB 45	103
FB 46	104
FB 47	106
FB 48	107
FB 49	109
FB 50	111
FB 52	238
FB 53	242
FB 55	167
FB 58	854
FB 59	871
FB 60	220
FB 61	223
FB 63	115
FB 64	118
FB 65	122, 225
FB 66	129
FB 67	131
FB 68	133
FB 70	183
FB 71	186
FB 72	190
FB 73	193
FB 80	795
FB 240	280
FB 241	280
FB 320	273
FB 321	276

FB 325	267	FB 880	507
FB 800	549	FB 881	507
FB 801	551	FB 882	509
FB 802	553	FB 885	449
FB 803	555	FB 886	541
FB 804	557	FB 887	541
FB 805	559	FC 0	230
FB 808	561	FC 1	232, 805
FB 811	563	FC 2	805
FB 812	565	FC 3	806
FB 813	567	FC 4	806
FB 814	569	FC 5	139, 807
FB 815	571	FC 6	142, 807
FB 816	573	FC 7	807
FB 817	575	FC 8	233, 808
FB 818	577	FC 9	234, 808
FB 819	579	FC 10	144, 808
FB 823	581	FC 11	236, 809
FB 824	583	FC 12	809
FB 825	584	FC 13	809
FB 826	586	FC 14	810
FB 827	588	FC 15	810
FB 828	590	FC 16	811
FB 829	592	FC 17	811
FB 830	594	FC 18	811
FB 831	596	FC 19	812
FB 832	598	FC 20	812
FB 833	600	FC 21	813
FB 834	602	FC 22	813
FB 835	604	FC 23	813
FB 836	606	FC 24	814
FB 837	608	FC 25	814
FB 838	610	FC 26	815
FB 860	544	FC 27	815
FB 870	322	FC 28	816
FB 871	322	FC 29	816
FB 872	360, 401	FC 30	817
FB 873	360	FC 31	817
FB 874	401	FC 32	818
FB 875	423	FC 33	818
FB 876	504	FC 34	819
FB 877	505	FC 35	819
FB 878	506	FC 36	819
FB 879	506	FC 37	820

FC 38	820	FC 215	910, 920
FC 39	821	FC 216	204
FC 40	821	FC 217	208
FC 53	689	FC 218	213
FC 61	879	FC 219	927
FC 62	151, 880	FC 254	929
FC 63	881	FC 300	246
FC 93	796	FC 301	248
FC 94	797	FC 302	251
FC 95	797	FC 303	253
FC 96	798	FC 310	256
FC 97	798	FC 311	258
FC 98	799	FC 312	260
FC 99	799	FC 313	262
FC 105	800	Fetch/Write Communication	883
FC 106	801	File Functions SPEED7 CPUs	910
FC 108	802	FKT Codes	197
FC 109	802	FR-ID	265
FC 110	803	Frame	265
FC 111	804	Frequency Measurement	246
FC 112	825	H	
FC 113	826	Hardware Interrupts	82
FC 114	827	HW_ID	66
FC 115	827	I	
FC 116	828	ID	264
FC 117	829	IEC	805
FC 118	830	IL operations	17
FC 119	830	Include VIPA library	69
FC 120	831	Instruction list	17
FC 121	832	Integrated Standard	645
FC 122	832	Internal blocks	15
FC 123	833	Inverter drive	
FC 124	834	EtherCAT	511
FC 125	834	Modbus RTU	452
FC 193	922	PWM	430
FC 194	926	IO	821
FC 195	910, 911	J	
FC 208	910, 912	Jump instructions	44
FC 209	910, 913	L	
FC 210	910, 914	Load instructions	38
FC 211	910, 915		
FC 212	910, 916		
FC 213	910, 918		
FC 214	910, 919		

M

Main	71
Math instructions	30
Measurand	264
Measured value	264
MMC Functions standard CPUs	906
Modbus Communication	183
Motion Modules	271

N

Network Communication	114
Null operation instructions	36

O

OB 1	71
OB 10	78
OB 11	78
OB 20	77
OB 21	77
OB 28	80
OB 29	80
OB 32	80
OB 33	80
OB 34	80
OB 35	80
OB 40	82
OB 41	82
OB 55	74
OB 56	75
OB 57	76
OB 80	84
OB 81	86
OB 82	87
OB 83	89
OB 85	92
OB 86	96
OB 100	72
OB 102	72
OB 121	98
OB 122	100
Onboard I/O System 100V	281
Open Communication	114
Organization Blocks	71

P

PID	835
PLCopen parameter	611
Program display operation instructions	36

R

RAM to WLD	280
Registers	27
Resetting bit addresses	43
RET_VAL	66
Room	103
RTU	190

S

S5 Converting	825
SDO Communication	238
Serial communication	203
Serial Communication	203
Setting bit addresses	43
SFB 0	729
SFB 1	730
SFB 2	731
SFB 3	733
SFB 4	734
SFB 5	735
SFB 7	931
SFB 8	154
SFB 9	155
SFB 12	158, 737
SFB 13	161, 740
SFB 14	163, 742
SFB 15	165, 744
SFB 31	746
SFB 32	748
SFB 33	752
SFB 34	754
SFB 35	756
SFB 36	759
SFB 47	760
SFB 48	765
SFB 49	767
SFB 52	775
SFB 53	776
SFB 54	777

SFC 0	645	SFC 54	690
SFC 1	645	SFC 55	692
SFC 2	646	SFC 56	694
SFC 3	646, 647	SFC 57	696
SFC 4	646, 647	SFC 58	698
SFC 5	648	SFC 59	700
SFC 6	650	SFC 64	702
SFC 7	652	SFC 65	703
SFC 12	653	SFC 66	705
SFC 13	657	SFC 67	708
SFC 14	659	SFC 68	711
SFC 15	660	SFC 69	714
SFC 17	661	SFC 70	716
SFC 18	661	SFC 71	717
SFC 19	663	SFC 75	921
SFC 20	664	SFC 81	720
SFC 21	666	SFC 101	721
SFC 22	667	SFC 102	722
SFC 23	669	SFC 105	723
SFC 24	670	SFC 106	726
SFC 25	670	SFC 107	727
SFC 28	671	SFC 108	727
SFC 29	671, 672	SFC 193	922
SFC 30	671, 673	SFC 194	926
SFC 31	671, 673	SFC 195	910, 911
SFC 32	674	SFC 207	203
SFC 33	675	SFC 208	910, 912
SFC 34	675	SFC 209	910, 913
SFC 36	676	SFC 210	910, 914
SFC 37	677	SFC 211	910, 915
SFC 38	678	SFC 212	910, 916
SFC 39	678	SFC 213	910, 918
SFC 40	680	SFC 214	910, 919
SFC 41	681	SFC 215	910, 920
SFC 42	681	SFC 216	204
SFC 43	682	SFC 217	208
SFC 44	682	SFC 218	213
SFC 46	682	SFC 219	927
SFC 47	683	SFC 220	906
SFC 49	683	SFC 221	906, 908
SFC 50	684	SFC 222	906, 909
SFC 51	685	SFC 223	281
SFC 52	687	SFC 224	283
SFC 53	689	SFC 225	285

SFC 228	883	UDT 872	360, 401
SFC 230	885, 897	UDT 877	504
SFC 231	885, 898	UDT 878	504
SFC 232	885, 899	UDT 879	504
SFC 233	885, 900	UDT 881	504
SFC 234	885, 901	UDT 886	541
SFC 235	885, 902		
SFC 236	885, 903		
SFC 237	885, 904		
SFC 238	885, 905		
SFC 254	929		
Shift instructions	41		
Sigma-5 EtherCAT	288		
Sigma-5/7 Pulse Train	405		
Sigma-7S EtherCAT	324		
Sigma-7W EtherCAT	362		
SPEED7 programming	25		
SSL System status list	932		
Standard	795		
Startup	72		
Synchronous Interrupts	98		
System Blocks	883		
System Function Blocks	729, 931		
System Functions	645, 921		
T			
TCP	183		
Time delay Interrupts	77		
Time of day Interrupts	78		
TimeFunctions	878		
Timer instructions	64		
Transfer instructions	47		
U			
UDT 3	108		
UDT 4	109		
UDT 60	878		
UDT 65	124		
UDT 66	136		
UDT 321	279		
UDT 325	268		
UDT 860	544, 548		
UDT 861	548		
UDT 870	322		