

VIPA System 200V

FM | Manual

HB97E_FM | RE_254-1BA00 | Rev. 13/02

January 2013



Copyright © VIPA GmbH. All Rights Reserved.

This document contains proprietary information of VIPA and is not to be disclosed or used except in accordance with applicable agreements.

This material is protected by the copyright laws. It may not be reproduced, distributed, or altered in any fashion by any entity (either internal or external to VIPA), except in accordance with applicable agreements, contracts or licensing, without the express written consent of VIPA and the business management owner of the material.

For permission to reproduce or distribute, please contact:
VIPA, Gesellschaft für Visualisierung und Prozessautomatisierung mbH
Ohmstraße 4, D-91074 Herzogenaurach, Germany
Tel.: +49 (91 32) 744 -0
Fax.: +49 9132 744 1864
EMail: info@vipa.de
<http://www.vipa.com>

Note

Every effort has been made to ensure that the information contained in this document was complete and accurate at the time of publishing. Nevertheless, the authors retain the right to modify the information. This customer document describes all the hardware units and functions known at the present time. Descriptions may be included for units which are not present at the customer site. The exact scope of delivery is described in the respective purchase contract.

CE Conformity Declaration

Hereby, VIPA GmbH declares that the products and systems are in compliance with the essential requirements and other relevant provisions.

Conformity is indicated by the CE marking affixed to the product.

Conformity Information

For more information regarding CE marking and Declaration of Conformity (DoC), please contact your local VIPA customer service organization.

Trademarks

VIPA, SLIO, System 100V, System 200V, System 300V, System 300S, System 400V, System 500S and Commander Compact are registered trademarks of VIPA Gesellschaft für Visualisierung und Prozessautomatisierung mbH.

SPEED7 is a registered trademark of profichip GmbH.

SIMATIC, STEP, SINEC, TIA Portal, S7-300 and S7-400 are registered trademarks of Siemens AG.

Microsoft und Windows are registered trademarks of Microsoft Inc., USA.

Portable Document Format (PDF) and Postscript are registered trademarks of Adobe Systems, Inc.

All other trademarks, logos and service or product marks specified herein are owned by their respective companies.

Information product support

Contact your local VIPA Customer Service Organization representative if you wish to report errors or questions regarding the contents of this document. If you are unable to locate a customer service center, contact VIPA as follows:

VIPA GmbH, Ohmstraße 4, 91074 Herzogenaurach, Germany

Telefax: +49 9132 744 1204
EMail: documentation@vipa.de

Technical support

Contact your local VIPA Customer Service Organization representative if you encounter problems with the product or have questions regarding the product. If you are unable to locate a customer service center, contact VIPA as follows:

VIPA GmbH, Ohmstraße 4, 91074 Herzogenaurach, Germany

Telephone: +49 9132 744 1150 (Hotline)
EMail: support@vipa.de

Contents

About this manual	1
Safety information	2
Chapter 1 Basics and Assembly	1-1
Safety Information for Users.....	1-2
System conception	1-3
Dimensions	1-5
Installation	1-7
Demounting and module exchange	1-11
Wiring.....	1-12
Installation guidelines	1-14
General data	1-17
Chapter 2 Hardware description	2-1
Properties.....	2-2
Structure	2-3
Technical data.....	2-7
Chapter 3 Deployment	3-1
Summary of parameters and transfer values.....	3-2
Parameterization	3-3
Data transfer CPU >> FM 254.....	3-4
Operating modes.....	3-6
Data transfer FM 254 >> CPU.....	3-12

About this manual

This manual describes the System 200V MotionControl servo module FM 254 from VIPA. Here you may find every information for commissioning and operation.

Overview

Chapter 1: Basics and Assembly

The focus of this chapter is on the introduction of the VIPA System 200V. Here you will find the information required to assemble and wire a controller system consisting of System 200V components.

Besides the dimensions the general technical data of System 200V will be found.

Chapter 2: Hardware description

Here the hardware components of the FM 254-1BA00 are described.

The technical data are at the end of the chapter.

Chapter 3: Deployment

This chapter contains information about the data transfer and the operating modes of the MotionControl servo module FM 254 for servo drives.

Objective and contents

This manual describes the System 200V MotionControl servo module FM 254 from VIPA. It contains a description of the construction, project implementation and usage.

This manual is part of the documentation package with order number HB97E_FM and relevant for:

Product	Order number	as of state: HW
FM 254	VIPA 254-1BA00	01

Target audience

The manual is targeted at users who have a background in automation technology.

Structure of the manual

The manual consists of chapters. Every chapter provides a self-contained description of a specific topic.

Guide to the document

The following guides are available in the manual:

- an overall table of contents at the beginning of the manual
- an overview of the topics for every chapter

Availability

The manual is available in:

- printed form, on paper
- in electronic form as PDF-file (Adobe Acrobat Reader)

Icons Headings

Important passages in the text are highlighted by following icons and headings:



Danger!

Immediate or likely danger.
Personal injury is possible.



Attention!

Damages to property is likely if these warnings are not heeded.



Note!

Supplementary information and useful tips.

Safety information

Applications conforming with specifications

The FM 254 is constructed and produced for:

- all VIPA System 200V components
- communication and process control
- general control and automation applications
- industrial applications
- operation within the environmental conditions specified in the technical data
- installation into a cubicle



Danger!

This device is not certified for applications in

- in explosive environments (EX-zone)

Documentation

The manual must be available to all personnel in the

- project design department
- installation department
- commissioning
- operation



The following conditions must be met before using or commissioning the components described in this manual:

- Hardware modifications to the process control system should only be carried out when the system has been disconnected from power!
- Installation and hardware modification only by properly trained personnel.
- The national rules and regulations of the respective country must be satisfied (installation, safety, EMC ...)

Disposal

National rules and regulations apply to the disposal of the unit!

Chapter 1 Basics and Assembly

Overview The focus of this chapter is on the introduction of the VIPA System 200V. Here you will find the information required to assemble and wire a controller system consisting of System 200V components. Besides the dimensions the general technical data of System 200V will be found.

Contents	Topic	Page
	Chapter 1 Basics and Assembly	1-1
	Safety Information for Users	1-2
	System conception	1-3
	Dimensions	1-5
	Installation	1-7
	Demounting and module exchange	1-11
	Wiring.....	1-12
	Installation guidelines	1-14
	General data	1-17

Safety Information for Users

Handling of electrostatic sensitive modules

VIPA modules make use of highly integrated components in MOS-Technology. These components are extremely sensitive to over-voltages that can occur during electrostatic discharges.

The following symbol is attached to modules that can be destroyed by electrostatic discharges.



The Symbol is located on the module, the module rack or on packing material and it indicates the presence of electrostatic sensitive equipment.

It is possible that electrostatic sensitive equipment is destroyed by energies and voltages that are far less than the human threshold of perception. These voltages can occur where persons do not discharge themselves before handling electrostatic sensitive modules and they can damage components thereby, causing the module to become inoperable or unusable.

Modules that have been damaged by electrostatic discharges can fail after a temperature change, mechanical shock or changes in the electrical load.

Only the consequent implementation of protection devices and meticulous attention to the applicable rules and regulations for handling the respective equipment can prevent failures of electrostatic sensitive modules.

Shipping of electrostatic sensitive modules

Modules must be shipped in the original packing material.

Measurements and alterations on electrostatic sensitive modules

When you are conducting measurements on electrostatic sensitive modules you should take the following precautions:

- Floating instruments must be discharged before use.
- Instruments must be grounded.

Modifying electrostatic sensitive modules you should only use soldering irons with grounded tips.



Attention!

Personnel and instruments should be grounded when working on electrostatic sensitive modules.

System conception

Overview

The System 200V is a modular automation system for assembly on a 35mm profile rail. By means of the peripheral modules with 4, 8 and 16 channels this system may properly be adapted matching to your automation tasks.

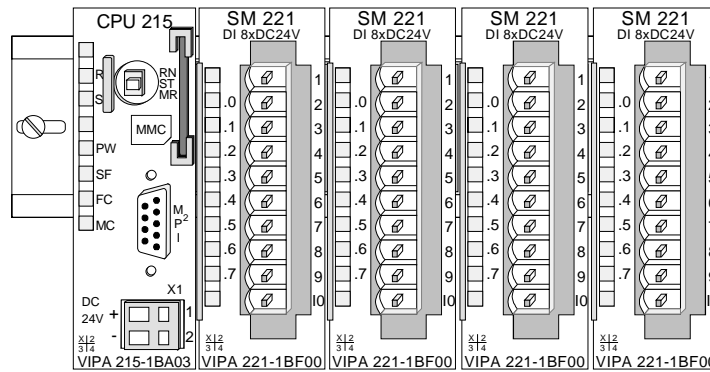

Components

The System 200V consists of the following components:

- Head modules like CPU and bus coupler
- Periphery modules like I/O, function und communication modules
- Power supplies
- Extension modules

Head modules

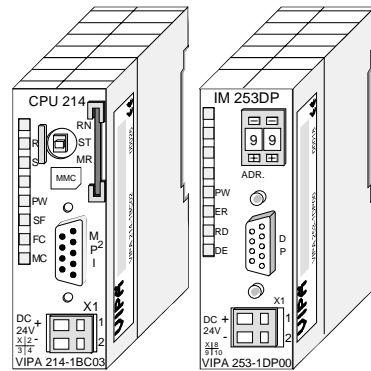

With a head module CPU respectively bus interface and DC 24V power supply are integrated to one casing.

Via the integrated power supply the CPU respectively bus interface is power supplied as well as the electronic of the connected periphery modules.

Periphery modules

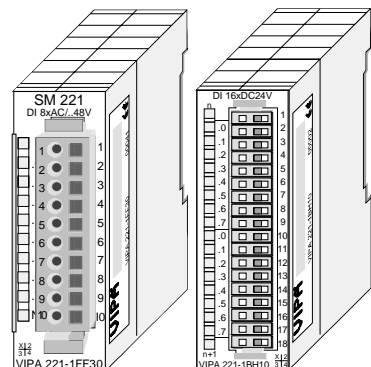

The modules are direct installed on a 35mm profile rail and connected to the head module by a bus connector, which was mounted on the profile rail before.

Most of the periphery modules are equipped with a 10pin respectively 18pin connector. This connector provides the electrical interface for the signaling and supplies lines of the modules.

Power supplies

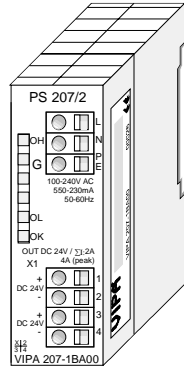

With the System 200V the DC 24V power supply can take place either externally or via a particularly for this developed power supply.

The power supply may be mounted on the profile rail together with the System 200V modules. It has no connector to the backplane bus.

Expansion modules

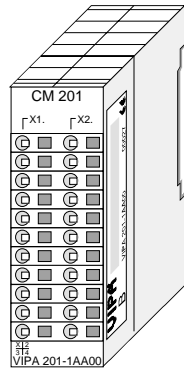

The expansion modules are complementary modules providing 2- or 3wire connection facilities.

The modules are not connected to the backplane bus.

Structure/ dimensions

- Profile rail 35mm
- Dimensions of the basic enclosure:
 - 1tier width: (HxWxD) in mm: 76x25.4x74 in inches: 3x1x3
 - 2tier width: (HxWxD) in mm: 76x50.8x74 in inches: 3x2x3

Installation

Please note that you can only install head modules, like the CPU, the PC and couplers at slot 1 or 1 and 2 (for double width modules).

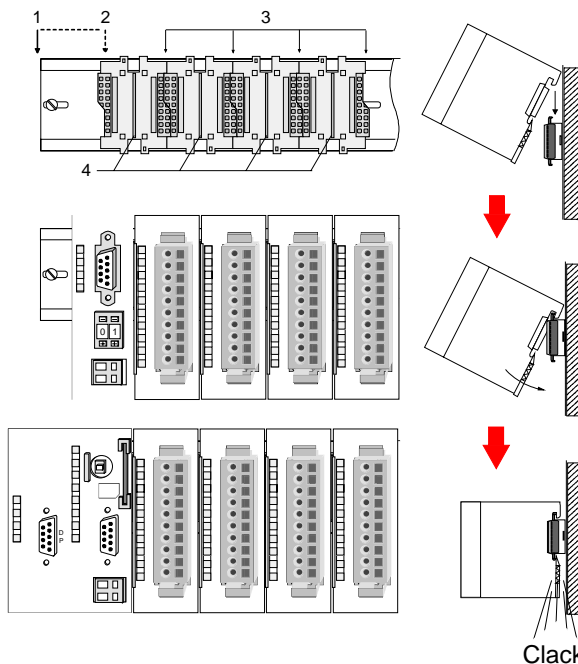

[1]	Head module (double width)
[2]	Head module (single width)
[3]	Periphery module
[4]	Guide rails

Note

Information about the max. number of pluggable modules and the max. current at the backplane bus can be found in the "Technical Data" of the according head module.

Please install modules with a high current consumption directly beside the head module.

Dimensions

Dimensions 1tier width (HxWxD) in mm: 76 x 25.4 x 74
Basic enclosure 2tier width (HxWxD) in mm: 76 x 50.8 x 74

Installation dimensions

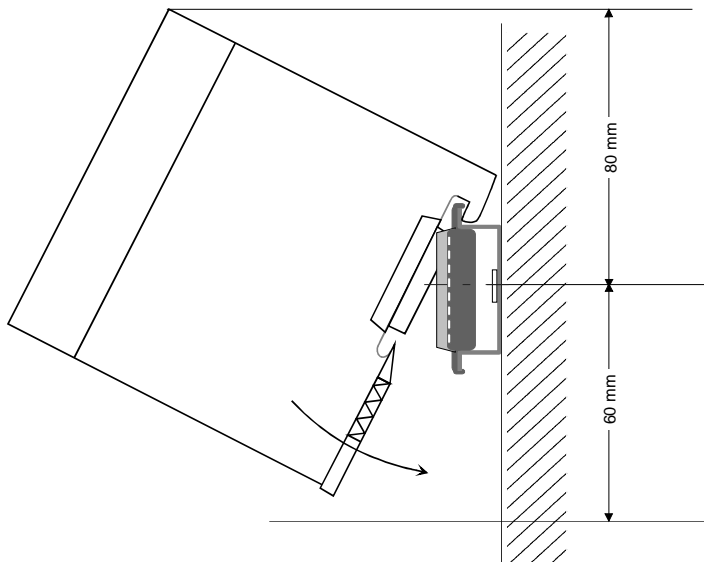

Installed and wired dimensions

In- / Output modules

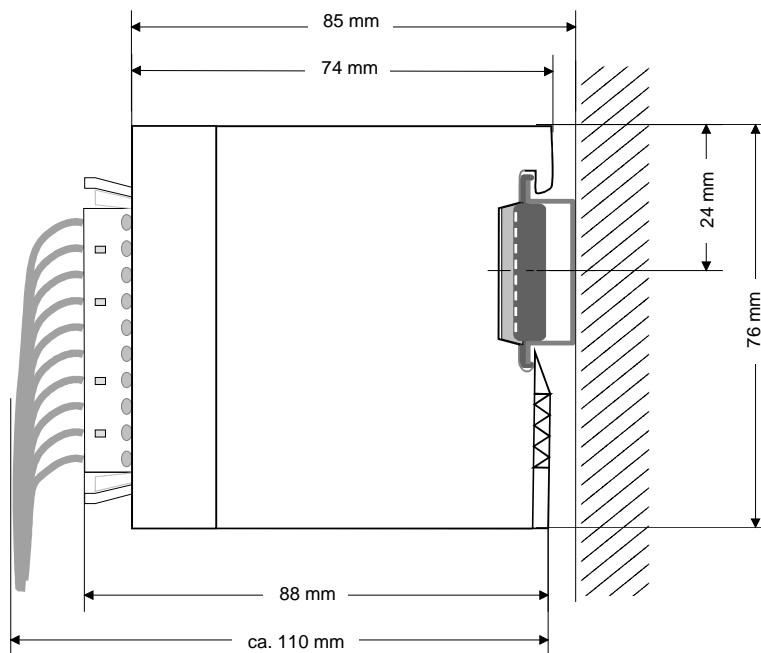

Function modules/
Extension modules

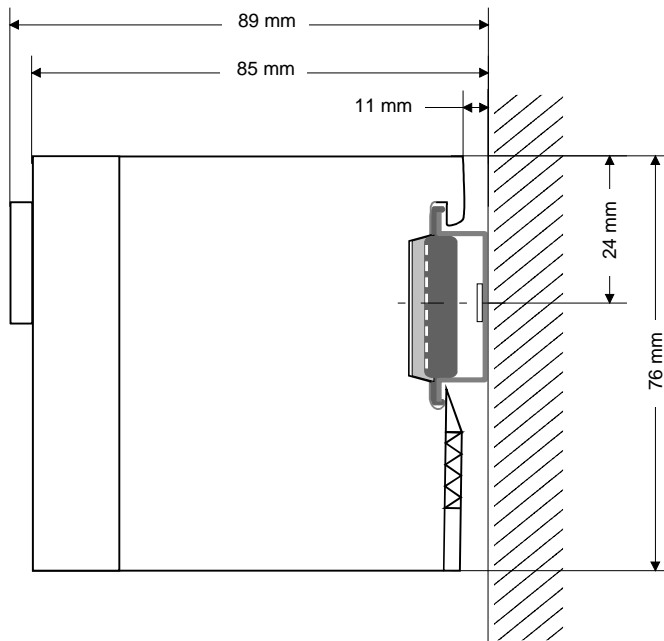

CPUs (here with
EasyConn from
VIPA)

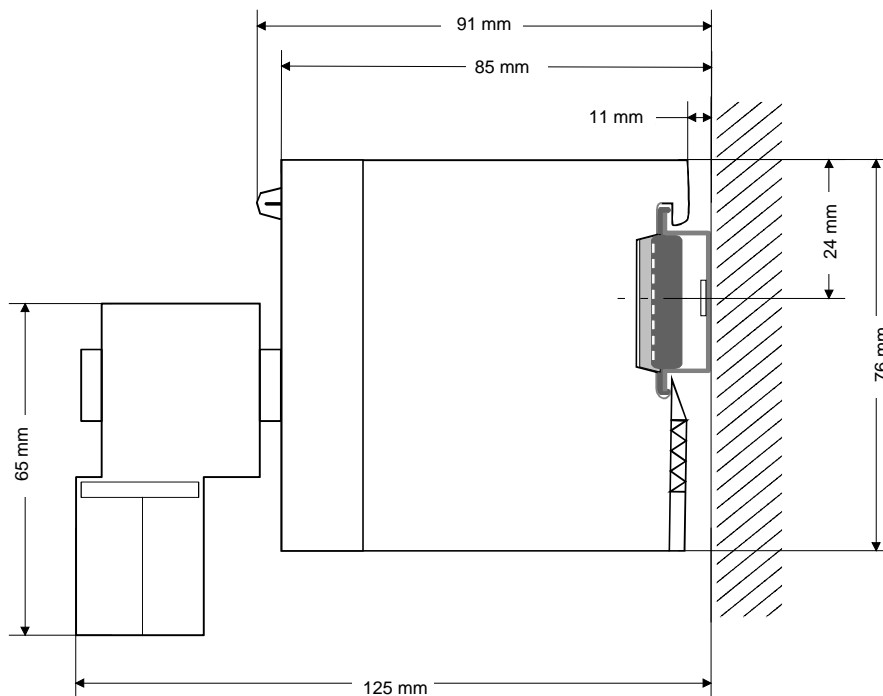

Installation

General

The modules are each installed on a 35mm profile rail and connected via a bus connector. Before installing the module the bus connector is to be placed on the profile rail before.

Profile rail

For installation the following 35mm profile rails may be used:

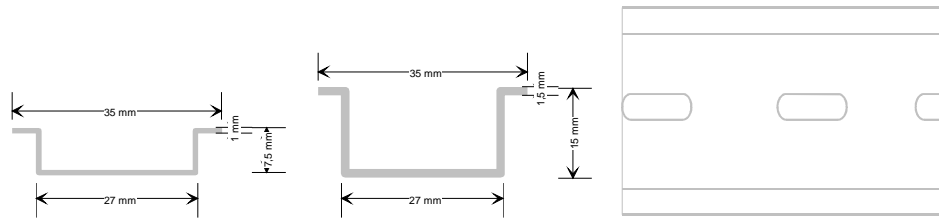

Order number	Label	Description
290-1AF00	35mm profile rail	Length 2000mm, height 15mm
290-1AF30	35mm profile rail	Length 530mm, height 15mm

Bus connector

System 200V modules communicate via a backplane bus connector. The backplane bus connector is isolated and available from VIPA in of 1-, 2-, 4- or 8tier width.

The following figure shows a 1tier connector and a 4tier connector bus:

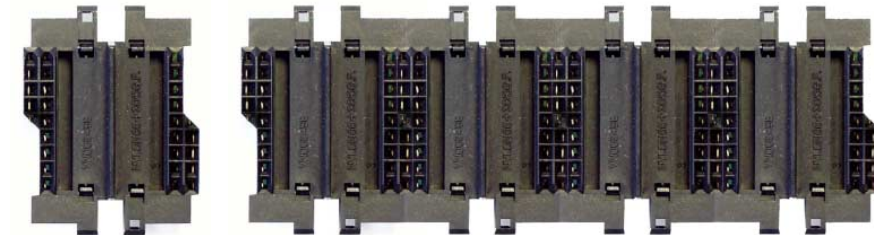

The bus connector is to be placed on the profile rail until it clips in its place and the bus connections look out from the profile rail.

Order number	Label	Description
290-0AA10	Bus connector	1tier
290-0AA20	Bus connector	2tier
290-0AA40	Bus connector	4tier
290-0AA80	Bus connector	8tier

Installation on a profile rail

The following figure shows the installation of a 4tier width bus connector in a profile rail and the slots for the modules.

The different slots are defined by guide rails.

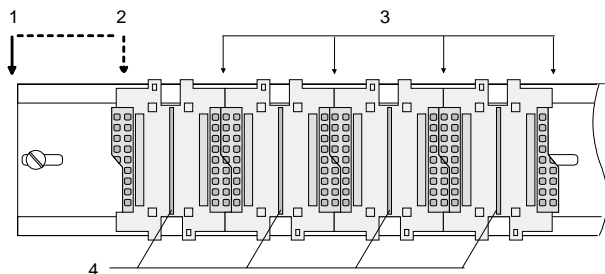

- [1] Head module (double width)
- [2] Head module (single width)
- [3] Peripheral module
- [4] Guide rails

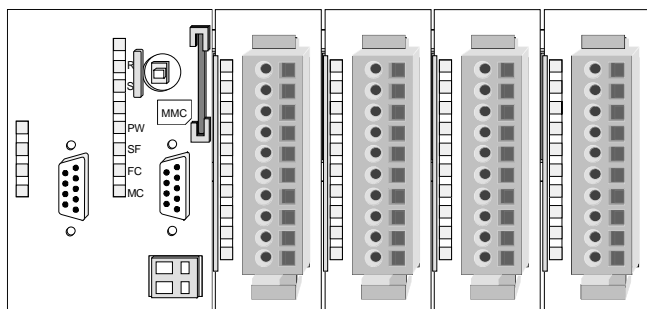
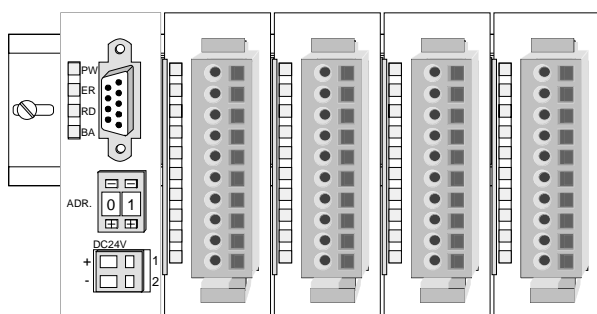

Assembly regarding the current consumption

- Use bus connectors as long as possible.
- Sort the modules with a high current consumption right beside the head module. In the service area of www.vipa.com a list of current consumption of every System 200V module can be found.

Assembly possibilities

horizontal assembly

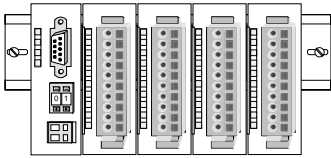

vertical assembly

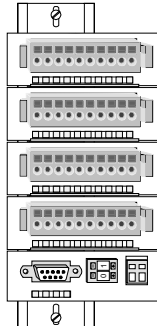

lying assembly

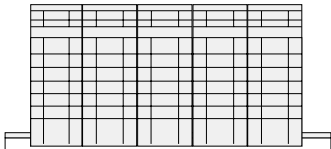

Please regard the allowed environmental temperatures:

- horizontal assembly: from 0 to 60°C
- vertical assembly: from 0 to 40°C
- lying assembly: from 0 to 40°C

The horizontal assembly always starts at the left side with a head module, then you install the peripheral modules beside to the right.

You may install up to 32 peripheral modules.

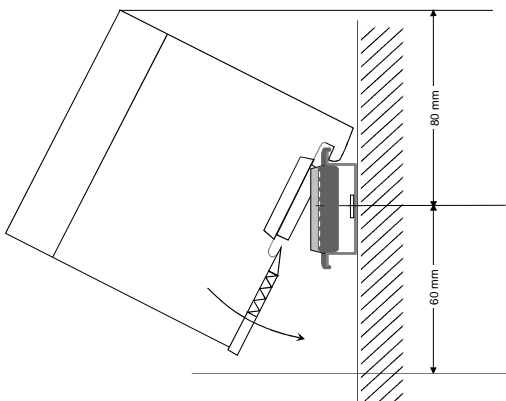

Please follow these rules during the assembly!

- Turn off the power supply before you install or remove any modules!
- Make sure that a clearance of at least 60mm exists above and 80mm below the middle of the profile rail.

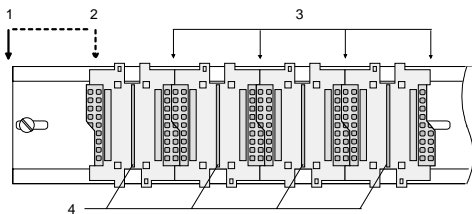

- Every row must be completed from left to right and it has to start with a head module.

- [1] Head module (double width)
- [2] Head module (single width)
- [3] Peripheral modules
- [4] Guide rails

- Modules are to be installed side by side. Gaps are not permitted between the modules since this would interrupt the backplane bus.
- A module is only installed properly and connected electrically when it has clicked into place with an audible click.
- Slots after the last module may remain unoccupied.



Note!

Information about the max. number of pluggable modules and the max. current at the backplane bus can be found in the "Technical Data" of the according head module.

Please install modules with a high current consumption directly beside the head module.

Assembly procedure

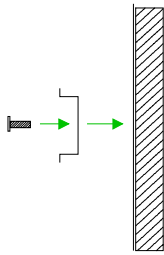

- Install the profile rail. Make sure that a clearance of at least 60mm exists above and 80mm below the middle of the profile rail.

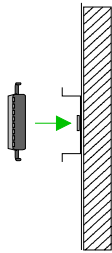

- Press the bus connector into the profile rail until it clips securely into place and the bus-connectors look out from the profile rail. This provides the basis for the installation of your modules.

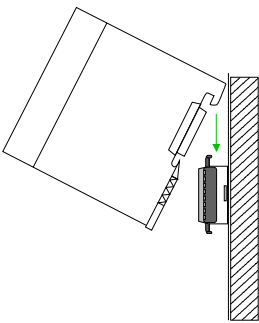

- Start at the outer left location with the installation of your head module and install the peripheral modules to the right of this.

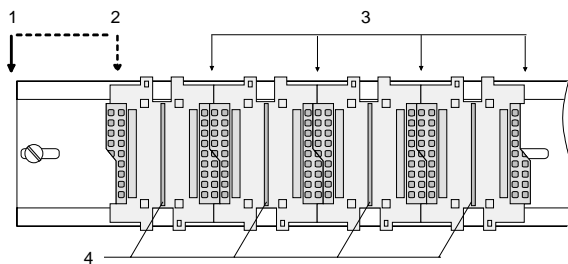

- [1] Head module (double width)
- [2] Head module (single width)
- [3] Peripheral module
- [4] Guide rails

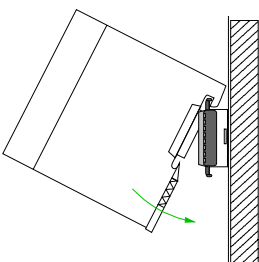

- Insert the module that you are installing into the profile rail at an angle of 45 degrees from the top and rotate the module into place until it clicks into the profile rail with an audible click. The proper connection to the backplane bus can only be guaranteed when the module has properly clicked into place.



Attention!

Power must be turned off before modules are installed or removed!

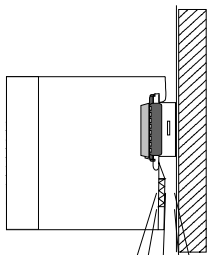

Clack

Demounting and module exchange

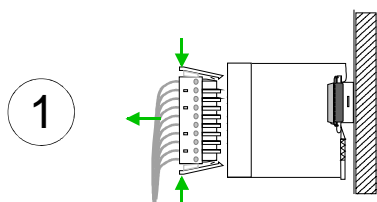

- Remove if exists the wiring to the module, by pressing both locking lever on the connector and pulling the connector.

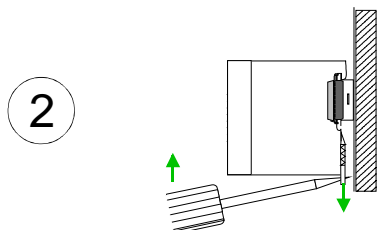

- The casing of the module has a spring loaded clip at the bottom by which the module can be removed.

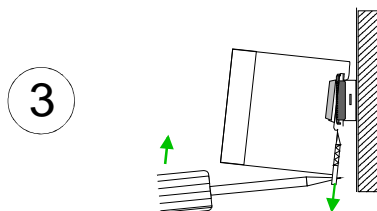

- The clip is unlocked by pressing the screwdriver in an upward direction.

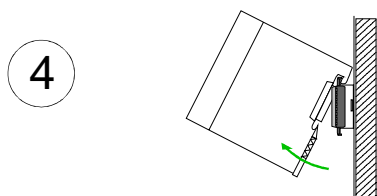

- Withdraw the module with a slight rotation to the top.

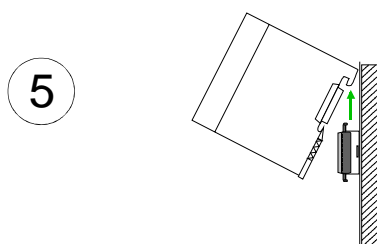

Attention!

Power must be turned off before modules are installed or removed!

Please regard that the backplane bus is interrupted at the point where the module was removed!

Wiring

Overview

Most peripheral modules are equipped with a 10pole or a 18pole connector. This connector provides the electrical interface for the signaling and supply lines of the modules.

The modules carry spring-clip connectors for interconnections and wiring.

The spring-clip connector technology simplifies the wiring requirements for signaling and power cables.

In contrast to screw terminal connections, spring-clip wiring is vibration proof. The assignment of the terminals is contained in the description of the respective modules.

You may connect conductors with a diameter from 0.08mm² up to 2.5mm² (max. 1.5mm² for 18pole connectors).

The following figure shows a module with a 10pole connector.

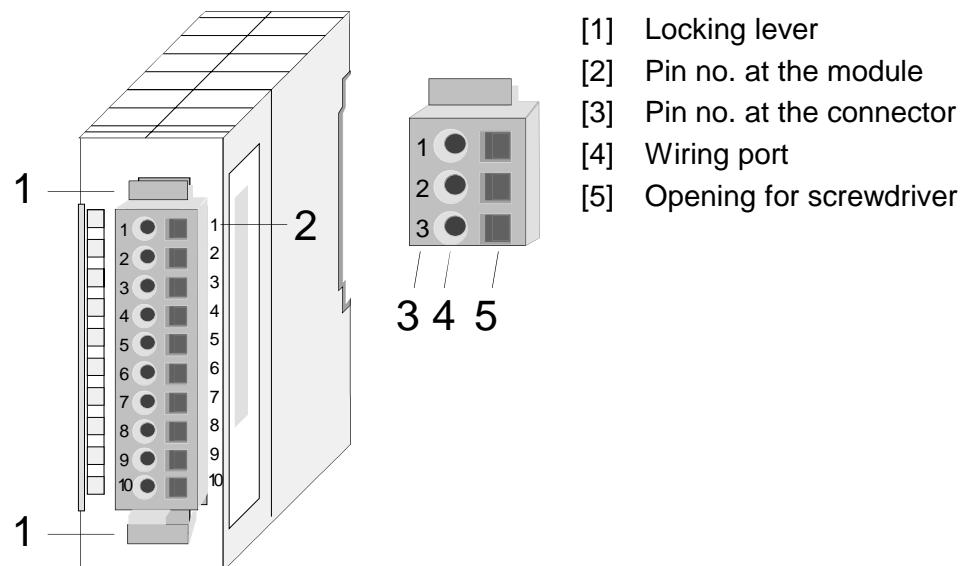

Note!

The spring-clip is destroyed if you push the screwdriver into the wire port! Make sure that you only insert the screwdriver into the square hole of the connector!

Wiring procedure

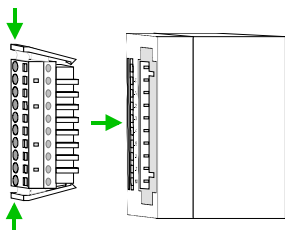

- Install the connector on the module until it locks with an audible click. For this purpose you press the two clips together as shown. The connector is now in a permanent position and can easily be wired.

The following section shows the wiring procedure from top view.

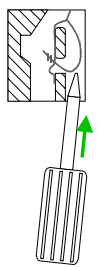

- Insert a screwdriver at an angle into the square opening as shown.
- Press and hold the screwdriver in the opposite direction to open the contact spring.

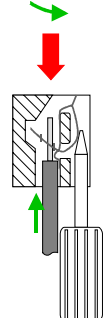

- Insert the stripped end of the wire into the round opening. You can use wires with a diameter of 0.08mm² to 2.5mm² (1.5mm² for 18pole connectors).

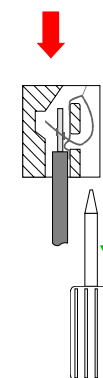

- By removing the screwdriver the wire is connected safely with the plug connector via a spring.



Note!

Wire the power supply connections first followed by the signal cables (inputs and outputs).

Installation guidelines

General The installation guidelines contain information about the interference free deployment of System 200V systems. There is the description of the ways, interference may occur in your control, how you can make sure the electromagnetic digestibility (EMC), and how you manage the isolation.

What means EMC? Electromagnetic digestibility (EMC) means the ability of an electrical device, to function error free in an electromagnetic environment without being interferenced res. without interfering the environment.
All System 200V components are developed for the deployment in hard industrial environments and fulfill high demands on the EMC. Nevertheless you should project an EMC planning before installing the components and take conceivable interference causes into account.

Possible interference causes Electromagnetic interferences may interfere your control via different ways:

- Fields
- I/O signal conductors
- Bus system
- Current supply
- Protected earth conductor

Depending on the spreading medium (lead bound or lead free) and the distance to the interference cause, interferences to your control occur by means of different coupling mechanisms.

One differs:

- galvanic coupling
- capacitive coupling
- inductive coupling
- radiant coupling

Basic rules for EMC

In the most times it is enough to take care of some elementary rules to guarantee the EMC. Please regard the following basic rules when installing your PLC.

- Take care of a correct area-wide grounding of the inactive metal parts when installing your components.
 - Install a central connection between the ground and the protected earth conductor system.
 - Connect all inactive metal extensive and impedance-low.
 - Please try not to use aluminum parts. Aluminum is easily oxidizing and is therefore less suitable for grounding.
- When cabling, take care of the correct line routing.
 - Organize your cabling in line groups (high voltage, current supply, signal and data lines).
 - Always lay your high voltage lines and signal res. data lines in separate channels or bundles.
 - Route the signal and data lines as near as possible beside ground areas (e.g. suspension bars, metal rails, tin cabinet).
- Proof the correct fixing of the lead isolation.
 - Data lines must be laid isolated.
 - Analog lines must be laid isolated. When transmitting signals with small amplitudes the one sided laying of the isolation may be favorable.
 - Lay the line isolation extensively on an isolation/protected earth conductor rail directly after the cabinet entry and fix the isolation with cable clamps.
 - Make sure that the isolation/protected earth conductor rail is connected impedance-low with the cabinet.
 - Use metallic or metalized plug cases for isolated data lines.
- In special use cases you should appoint special EMC actions.
 - Wire all inductivities with erase links.
 - Please consider luminescent lamps can influence signal lines.
- Create a homogeneous reference potential and ground all electrical operating supplies when possible.
 - Please take care for the targeted employment of the grounding actions. The grounding of the PLC is a protection and functionality activity.
 - Connect installation parts and cabinets with the System 200V in star topology with the isolation/protected earth conductor system. So you avoid ground loops.
 - If potential differences between installation parts and cabinets occur, lay sufficiently dimensioned potential compensation lines.

Isolation of conductors

Electrical, magnetically and electromagnetic interference fields are weakened by means of an isolation, one talks of absorption.

Via the isolation rail, that is connected conductive with the rack, interference currents are shunt via cable isolation to the ground. Hereby you have to make sure, that the connection to the protected earth conductor is impedance-low, because otherwise the interference currents may appear as interference cause.

When isolating cables you have to regard the following:

- If possible, use only cables with isolation tangle.
- The hiding power of the isolation should be higher than 80%.
- Normally you should always lay the isolation of cables on both sides. Only by means of the both-sided connection of the isolation you achieve high quality interference suppression in the higher frequency area.
Only as exception you may also lay the isolation one-sided. Then you only achieve the absorption of the lower frequencies. A one-sided isolation connection may be convenient, if:
 - the conduction of a potential compensating line is not possible
 - analog signals (some mV res. μ A) are transferred
 - foil isolations (static isolations) are used.
- With data lines always use metallic or metalized plugs for serial couplings. Fix the isolation of the data line at the plug rack. Do not lay the isolation on the PIN 1 of the plug bar!
- At stationary operation it is convenient to strip the insulated cable interruption free and lay it on the isolation/protected earth conductor line.
- To fix the isolation tangles use cable clamps out of metal. The clamps must clasp the isolation extensively and have well contact.
- Lay the isolation on an isolation rail directly after the entry of the cable in the cabinet. Lead the isolation further on to the System 200V module and **don't** lay it on there again!

**Please regard at installation!**

At potential differences between the grounding points, there may be a compensation current via the isolation connected at both sides.

Remedy: Potential compensation line.

General data

Structure/ dimensions

- Profile rail 35mm
- Peripheral modules with recessed labelling
- Dimensions of the basic enclosure:
1tier width: (HxWxD) in mm: 76x25.4x74 in inches: 3x1x3
2tier width: (HxWxD) in mm: 76x50.8x74 in inches: 3x2x3

Reliability

- Wiring by means of spring pressure connections (CageClamps) at the front-facing connector, core cross-section 0.08 ... 2.5mm² or 1.5mm² (18pole plug)
- Complete isolation of the wiring when modules are exchanged
- Every module is isolated from the backplane bus
- ESD/Burst acc. IEC 61000-4-2 / IEC 61000-4-4 (to level 3)
- Shock resistance acc. IEC 60068-2-6 / IEC 60068-2-27 (1G/12G)
- Class of protection IP20

Environmental conditions

- Operating temperature: 0 ... +60°C
- Storage temperature: -25 ... +70°C
- Relative humidity: 5 ... 95% without condensation
- Ventilation by means of a fan is not required

Chapter 2 Hardware description

Overview Here the hardware components of the FM 254-1BA00 are described.
The technical data are at the end of the chapter.

Contents	Topic	Page
	Chapter 2 Hardware description.....	2-1
	Properties.....	2-2
	Structure	2-3
	Technical data.....	2-7

Properties

FM 254 254-1BA00

The FM 254 is a positioning module for controlling a servo drive. The modules may be used for point-to-point positioning as well as for complex drive outlines with need for a high level of precision, dynamics and speed. The module works independently and is controlled via an according user application at the CPU.

The module has the following characteristics:

- Microprocessor controlled positioning module for drives with an analog set point interface ($\pm 10V$ control voltage)
- Different operating modes
- Closed-loop position control
- The module contains 3 inputs for connecting end switches and is able to control 2 outputs.
The states of the in-/outputs are additionally shown via LEDs.
- Power supply DC 24V via front-side and DC 5V via backplane bus

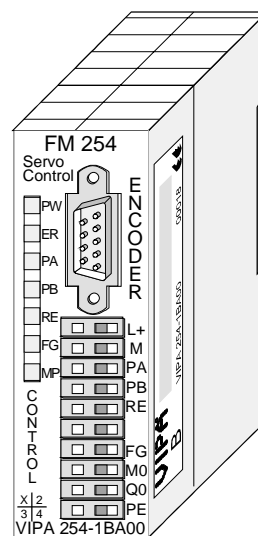

Note!

The explanations on this module refer to a firmware version beginning at 111. You can find the firmware version on a label on the backside of the module.

Order data

Type	Order number	Description
FM 254	VIPA 254-1BA00	MotionControl Module Servo

Structure

Front view

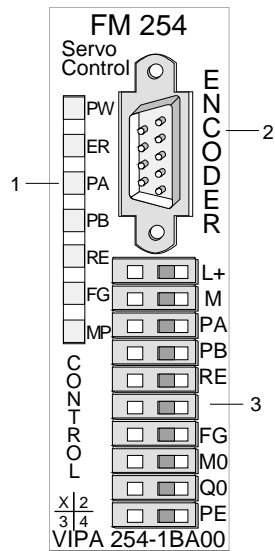

- [1] LED status indicators
- [2] Encoder interface
- [3] Connector for supply voltage, drive, end switch and outputs

Interfaces

ENCODER

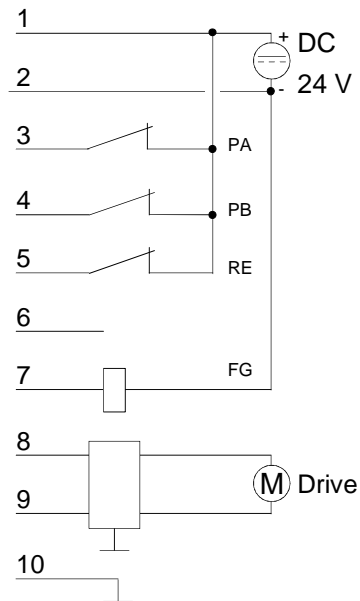
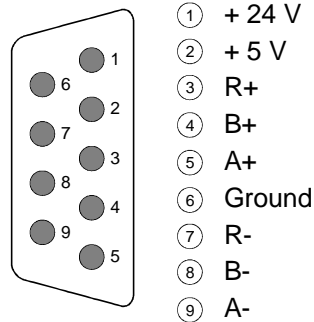

Encoder interface *9pin D-type plug*

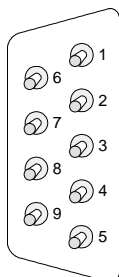

Pin	Assignment
1	+24V encoder power
2	+5V encoder power
3	R+ clock input null pulse
4	B+ clock input
5	A+ clock input
6	Ground encoder power
7	R- clock input null pulse
8	B- clock input
9	A- clock input

Connection of an encoder via encoder interface

The encoder is wired to the 9pin D-type connector located at the front. The module supplies the encoder with the required DC 24V and DC 5V voltages.

The following figure shows the connection of an encoder:

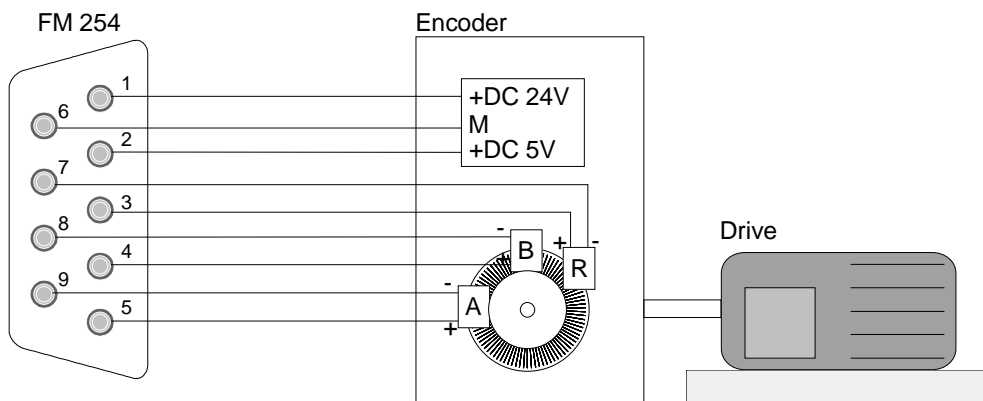

Attention!

Please regard you only may attach encoder with 5V signal level (RS422).

Control interface



Pin	Assignment
1	DC 24V supply voltage
2	Ground 24V
3	Input for start switch (low active)
4	Input for end switch (low active)
5	Input for reference switch (low active)
6	reserved
7	Output regulator release
8	Analog output ground
9	Analog output +
10	Screen

Connection of supply voltage, drive, end switch and outputs via control interface

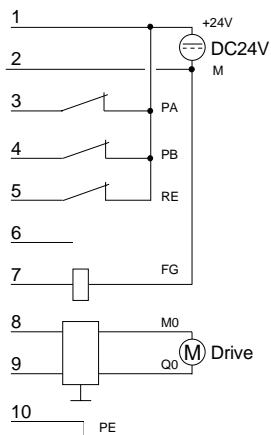

Power supply

The module requires a power supply of DC 24V via pin 1 and 2.

End switches

You may connect up to 3 end switches (opener) to the module.

The end switches for the extremes of the distance are connected to terminals 3 and 4. The drive will be stopped immediately as soon as one of these switches is operated. In this situation may only be driven into the opposite direction.

The reference switch is connected to terminal 5. This is required to tune the drive to the positioning module.

The end switch that stops the drive in the mode hardware-controlled run is also connected to terminal 5.

Outputs

The module has 2 outputs that are controlled directly by the module. At present, however, only the output "Controller Enable" (pin 7) is available. The second output is intended for future expansion. You enable the output by setting bit 0 in the traversing data.

Drive

Pin 8 and 9 supply an analog signal for $\pm 10V$ regulator control.

LEDs

The positioning module FM 254 has status indicator LEDs.

The following table contains the description and the respective color of these LEDs.

LED	Color	Description
PW	green	24V DC supply voltage is applied
ER	red	internal error
PA	yellow	Limit value A overrun, input PA is set
PB	yellow	Limit value B overrun, input PB is set
RE	yellow	Reference point overrun
FG	yellow	Drive released
MP	yellow	Blinking always when supply voltage via backplane bus is applied (Heartbeat - 2Hz)

**Note!**

If the PW-LED is not on during operation, this may depend on a short circuit in the DC 24V voltage supply.

Please control also the connections of the encoder plug.

Technical data

MotionControl Servo module FM 254

Order number	254-1BA00
Type	FM 254
Current consumption/power loss	
Current consumption from backplane bus	200 mA
Power loss	2.5 W
Status information, alarms, diagnostics	
Status display	yes
Interrupts	no
Process alarm	no
Diagnostic interrupt	no
Diagnostic functions	no
Diagnostics information read-out	none
Supply voltage display	yes
Group error display	red LED
Channel error display	none
Datasizes	
Input bytes	16
Output bytes	16
Parameter bytes	18
Diagnostic bytes	0
Housing	
Material	PPE / PA 6.6
Mounting	Profile rail 35 mm
Mechanical data	
Dimensions (WxHxD)	25.4 x 76 x 78 mm
Weight	130 g
Environmental conditions	
Operating temperature	0 °C to 60 °C
Storage temperature	-25 °C to 70 °C
Certifications	
UL508 certification	yes

Additional Technical Data

Electrical data	254-1BA00
Voltage supply	DC 24 V (20.4 ... 28.8 V) via front from ext. power supply
Current consumption Control interface	200 mA
Connectors / interfaces	
Encoder	Incremental encoder
Signal voltages	5 V as per RS 422
Supply voltage	5.2 V / 300 mA 24 V / 300 mA
Count frequency	200 000 Pulse/s = 50 000 Increments/s
Control	
Scanning interval	2 ms
Set point output	-10 ... +10 V
Digital inputs	
Number	3
Supply voltage	DC 24 V
Digital outputs	
Number	1
Potential separation	no
Output current	0.5 A
Lamp load	5 W

Chapter 3 Deployment

Overview This chapter contains information about the data transfer and the operating modes of the MotionControl servo module FM 254 for servo drives.

Contents	Topic	Page
	Chapter 3 Deployment	3-1
	Summary of parameters and transfer values	3-2
	Parameterization	3-3
	Data transfer CPU >> FM 254	3-4
	Operating modes.....	3-6
	Data transfer FM 254 >> CPU	3-12

Summary of parameters and transfer values

Overview The following table lists all the parameters and transfer values.

Value	Size	Unit	Physical range
Destination position Set position Actual position	32Bit	1	32 Bit Integer
Maximum rpm.	16Bit	1/min	100 ... 6000 1/min
Acceleration time Delay time	16Bit	10ms	20ms ... 30s
P-amplification	16Bit	0.1	0.0 ... 1000.0
Pre-control factor	16Bit	0.1	0.0 ... 1.0
Encoder increments	16Bit	1	10 ... 10000
Operating mode	16Bit	binary coding	

Block diagram A block diagram depicts the interaction between the parameters.

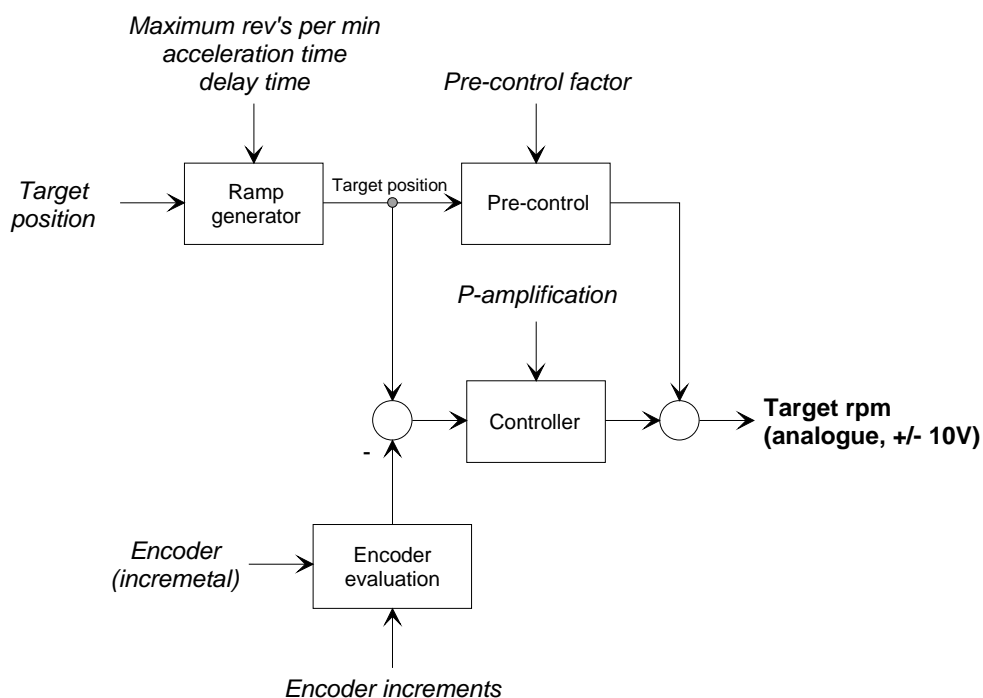

Parameterization

Parameter data (write only)

When commissioning the MotionControl Servo module it requires 16Byte of parameter data. These have the following structure:

Byte no.	Name	Length	Range	Unit
1, 0	Maximum rotat. speed	2Byte	10 ... 6000	1/min
3, 2	reserved	2Byte	-	-
5, 4	reserved	2Byte	-	-
7, 6	P-amplification	2Byte	0.0 ... 1000.0	0.1
9, 8	Pre-control factor	2Byte	0.0 ... 1.0	0.1
11, 10	Encoder increments	2Byte	10 ... 10000	1
13, 12	Reference rot. speed	2Byte	1 ... 6000	1/min
14	Pos. reached window	1Byte	0 ... 255	1INK
15	Drag distance	1Byte	0 ... 1020	4INK

Parameter description

Maximum rotational speed

Defines the maximum rotations for your drive.

If the product of maximum rotational speed and encoder increments is exceeding the value 3 000 000, the maximum rotational speed will be limited to the value of 3 000 000/encoder increments.

P-amplification, Pre-control factor

These values control the regulation properties.

Encoder increments

This parameter matches your MotionControl Servo module to the encoder.

Reference rotational speed

This value for the rotational speed is used for the reference run that is required by the MotionControl Servo module to re-acquire parameters for the control path.

If the rotational speed in the input byte 6 and 7 is smaller than the reference rotational speed, the rotational speed of the input byte 6 and 7 will be used as reference rotational speed.

Pos-reached-window

When the target position has been reached, this position is maintained by continuous control of the drive. The drive is never stopped.

You can specify a window by entering certain increments into the *Pos-reached-window*. These define the tolerance by which the actual value may differ from the target position before the drive is controlled, i.e. when the drive is stationary.

Drag distance

This parameter defines the drag error or the difference between the actual and the set value, which causes the drive to be stopped.

If the value is 0, the drag error supervision will be switched off.

Data transfer CPU >> FM 254

Traversing data The CPU can control the MotionControl Servo module by writing the following values into the FM 254 module:

Byte no.	Name	Length	Range	Unit
3, 2, 1, 0	Target position	4Byte	32 Bit Integer	Encoder increments
5, 4	Control bytes	2Byte		
7, 6	Rot. speed	2Byte	1 ... 6000	1/min
9, 8	Acceleration time	2Byte	2 ... 3000	10ms
13, 12, 11, 10	Parameter field	4Byte		
15, 14	Field identifier	2Byte		

Control bytes (Byte 4 and Byte 5)

Byte	Bit 7 ... 0
4	Bit 0: Enable Bit 1: Operating mode reference run positive Bit 2: Operating mode reference run negative Bit 3: Operating mode hardware-controlled run positive Bit 4: Operating mode hardware-controlled run negative Bit 5: Operating mode incremental dimension Bit 6: Operating mode infinite incremental dimension Bit 7: Taking over target position
5	Bit 0: Reset counter at non-maintained command mode (edge 0 after 1 sets back the actual position to zero) Bit 1: Non-maintained command mode direction of rotation pos. Bit 2: Non-maintained command mode direction of rotation neg. Bit 3: Stop bit Bit 7 ... 4: reserved



Attention!

Bit Enable (Control byte 4, Bit 0)

At digital and analog outputs of FM 254 "0" will be read-out if the release bit is reset during transmission.

After repeated setting of the release bit (Byte 4, Bit 0) the module is continuing the interrupted order if no new order is available.

Stop bit: (Control byte 5, Bit 3)

If the stop bit is set during transmission, the drive is stopped with the specified delay time. If the stop bit is reset during the delay, the stop order will be deleted and the order previously defined will be carried out. If the drive comes to rest, the target position will be equated with the actual position and the order will be finished.

Prior to deleting the stop bit, control bits (Byte 4 and 5) must be cancelled. Otherwise a new order will be placed.



Note!

Reset: (Control byte 5, Bit 0)

The reset of the counter may only be executed in the non-maintained command mode. During positioning mode the regulator would throw a drag error because of the jumping actual value.

Traversing data

Parameter field and Field identifiers (Byte 10 ... Byte 15)

You can send additional parameters with the traversing data to the MotionControl Servo module by specifying a field identifier. The parameters for the respective field identifier must be entered into the parameter field (Byte 10...13).

The FM 254 will use the default settings shown below if you do not transfer any field identifiers.

Field ident.	Description	Range	Unit	Default setting
FF01h	Software end switch (+)	32Bit Integer	Encoder increments	7FFF.FFFF
FF02h	Software start switch (-)	32Bit Integer	Encoder increments	8000.0001
FF03h	Rot. speed at non-maintained command mode	1 ... 6000 ¹⁾	1/min	Reference rotational speed
FF04h	Delay time	1 ... 10000	10ms	Acceleration time

¹⁾ If the rotational speed in control byte 6, 7 is smaller than the non-maintained mode rotational speed, the rotational speed of control byte 6, 7 will be used as non-maintained rotational speed.

Count frequency

If the counter frequency considerably exceeds the value of 200 000 pulse/s respectively 50 000 increments longer than 1ms, the drive will be stopped.

In operational state byte 11 bit 3 will be set for internal error.

The LED “internal module error” at the front side of the module will lighten.

By resetting the release bit you can delete the “internal error-bit”. The setpoint position will be equated with the actual position.

Operating modes

Overview

The following operating modes can be selected by setting the respective bit in the control byte:

- Positioning operation (positioning to an absolute target position)
- Reference run (system calibration)
- Hardware run (drive to reference switch)
- Incremental run (use addition to approach a relative target)
- Infinite incremental run (relative traversal without counter overflow)
- Non-maintained command mode

Positioning mode

Operation

During the positioning operation the absolute target position is only transferred to the FM 254, if the bit "Taking over target position" is set.

If a new position is specified with the enable bit set, the drive moves to the respective position \pm Position reached window with the values that were previously specified for the rotational speed and the acceleration/delay and sets the "Position reached"-Bit. After transferring the parameters for the traversal, you can start the drive by setting the enable bit. During the traversal the module indicates the direction of rotation by setting bit 1 or 2 in Operating state byte 10.

Should the deviation between set and actual position exceed the window specified for the drag error, the positioning operation is terminated and the motor is stopped. The program is notified by means of an active drag error bit 0 in Operating state byte 11. You can clear the drag error bit by resetting the enable bit. This also sets the set position to the actual position.

The drive is also stopped if soft- or hardware switches are passed that terminate the traversal distance.

The operation can be continued at any time by setting the enable bit.

The acceleration/delay time can be modified before a new command is issued.

It is always possible to specify a new value for the rotational speed by modifying the traversing data. If the rotational speed is changed while movement is taking place, the new value is attained respecting the current acceleration/delay times.

Control bytes

The control bytes that you use to specify this operating mode are an integral part of the traversal data.

A general description of the traversal data is available above.

Byte	Bit 7 ... 0
4	Bit 0: enable (drive is started) Bit 6 ... 1: 0 Bit 7: irrelevant
5	Irrelevant

Reference run

Operation

The reference run calibrates your drive system. The point of reference should be located on the path of traversal.

Start the reference run:

- Set the enable bit.
- Release the reference run by means of the bit "Reference run positive" or "Reference run negative".
 - The drive will travel to the point of reference using the reference rotational speed specified in the parameter set.
 - As soon as the point of reference is passed, the reference switch is operated (LED RE is turned off).
 - The position of the point of reference is recorded in memory.
 - The drive is reversed up to the next encoder zero pulse.

This concludes the reference run and the bit "Reference detected" is set.



Note!

Please remember that a set position is not required for operating mode "Reference run". The set position is ignored.

Control bytes

The control bytes that you use to select this operating mode are included in the traversing data.

A general description of the traversal data is available above.

Byte	Bit 7 ... 0
4	Bit 0: enable (drive is started) Bit 2 ... 1: 01: reference run positive 10: reference run negative Bit 7 ... 3: 0
5	Irrelevant

Operating mode

Hardware run

Operation

This mode is only used to approach a target position until the drive is stopped by an overrun end switch. The end switch must be connected to the reference switch input.

The traversal is governed by the values that were specified for rotational speed and acceleration or delay times. After the end switch is reached the respective position the drive is stopped with the specified delay time.

The acceleration/delay time can be modified before a new job is initiated.

If the rotational speed is altered when during the traversal, the new value is achieved by means of the current acceleration/delay time values.



Note!

Please remember that a set position is not required for operating mode "Hardware run". The set position is ignored.

Control bytes

The control bytes that you use to select this operating mode are included in the traversing data.

A general description of the traversal data is available above.

Byte	Bit 7 ... 0
4	Bit 0: enable (drive is started) Bit 2 ... 1: 0 Bit 4 ... 3: 01: Hardware run positive 10: Hardware run negative Bit 7 ... 5: 0
5	Irrelevant

Operating mode**Incremental run****Operation**

The incremental mode makes use of relative positions, i.e. the value supplied as set position is added to the actual position.

When the enable bit is set, the drive travels in a positive or negative direction for the specified relative value. The drive uses the predefined values for rotational speed and acceleration to travel to the new position. If the position is negative the drive will be reversed.

You can modify the acceleration/delay time before you initiate a new job.

If the rotational speed is altered when during the traversal, the new value is achieved by means of the current acceleration/delay time values.

Control bytes

The control bytes that you use to select this operating mode are included in the traversing data.

A general description of the traversal data is available above.

Byte	Bit 7 ... 0
4	Bit 0: enable (drive is started) Bit 4 ... 1: 0 Bit 5: 1 (Incremental run) Bit 7 ... 6: 0
5	Irrelevant

Operating mode

**Infinite
incremental
mode**

Operation

In this mode the position supplied as a value is approached as a absolute position when enabled. When the position is reached, the set and the actual position are set to zero. You can use this mode to move the drive in one direction without counter overflow condition.

You can modify the acceleration/delay time before you initiate a new job.

You may specify a new value for the rotational speed at any time. If the rotational speed is altered during the traversal, the new value is achieved by means of the current acceleration/delay time values.

Control bytes

The control bytes that you use to select this operating mode are included in the traversing data.

A general description of the traversal data is available above.

Byte	Bit 7 ... 0
4	Bit 0: enable (drive is started) Bit 5 ... 1: 0 Bit 6: 1 (Infinite incremental run) Bit 7: 0
5	Irrelevant

**Operating mode
Non-maintained
command mode**

Operation

The drive is released by setting Bit 0 in Byte 4 (enable) with before opposed rotational speed and acceleration. By setting Bit 1 or Bit 2 in Byte 5, a rotation direction is given and the drive starts. The drive stops as soon as Bit 1 or Bit 2 of Byte 5 is set back.

Control bytes

The control bytes that you use to select this operating mode are included in the traversing data.

A general description of the traversal data is available above.

Byte	Bit 7 ... 0
4	Bit 0: enable (drive is started)
5	Bit 0: Reset counter at non-maintained command mode (edge 0 after 1 sets back the actual position to zero) Bit 1: 1 direction of rotation positive Bit 2: 1 direction of rotation negative



Note!

The reset of the counter may only be executed in the non-maintained command mode. During positioning mode the regulator throw a drag error because of the jumping actual value.

Data transfer FM 254 >> CPU

The following values are transferred cyclically by the MotionControl Servo module to the CPU and stored.

Byte no.	Name	Length	Range	Unit
3, 2, 1, 0	Set position	4Byte	32Bit Integer	Encoder increments
7, 6, 5, 4	Actual position	4Byte	32Bit Integer	Encoder increments
9, 8	Set rotational speed (Value at input of A/D transducer)	2Byte	16Bit Integer	1
11, 10	Operating mode	2Byte	binary coded	
13, 12	reserved	2Byte	-	-
15, 14	Reply field identifier	2Byte		hex

Operating state

Byte	Bit 7 ... 0
10	Bit 0: enable issued Bit 1: clockwise rotation Bit 2: anticlockwise rotation Bit 3: position reached Bit 4: HW start switch operated Bit 5: HW end switch operated Bit 6: HW reference switch operated Bit 7: Reference detected
11	Bit 0: Drag error detected Bit 2 ... 1: reserved Bit 3: Internal Error Bit 4: SW end switch anticlockwise rotation Bit 5: SW end switch clockwise rotation Bit 6: Unacceptable mode Bit 7: reserved

Example

If the MotionControl Servo module was addressed starting at peripheral address PY128 in your CPU, you may obtain the "set position" from PY128 to PY131.

Other values follow these values in the peripheral area in accordance with the list above.

For example, the 2Byte for the "Operating state" are located at PY138 ... PY139.